



KW-V420BT KW-V320BT KW-V220BT

MONITOR WITH DVD RECEIVER INSTRUCTION MANUAL

JVCKENWOOD Corporation

This instruction manual is used to describe models listed below. Model availability and features (functions) may differ depending on the country and sales area.

- Region 2 (DVD Region Code 2 area)
- Region 5 (DVD Region Code 5 area)



CONTENTS

| | | | |
|--|-----------|---|-----------|
| BEFORE USE | 2 | BLUETOOTH | 31 |
| How to reset your unit..... | 3 | SETTINGS | 39 |
| INITIAL SETTINGS | 4 | Settings for using applications of iPod touch/ iPhone/Android..... | 39 |
| Initial setup..... | 4 | Sound adjustment | 40 |
| Clock settings | 4 | Adjustment for video playback..... | 43 |
| BASICS | 5 | Changing the display design..... | 44 |
| Component names and functions | 5 | Customizing the Home screen..... | 45 |
| Common operations..... | 7 | Customizing the system settings..... | 46 |
| Common screen operations..... | 8 | Setting menu items..... | 48 |
| Selecting the playback source..... | 10 | REMOTE CONTROLLER | 51 |
| Using the pop-up short-cut menu..... | 11 | CONNECTION/INSTALLATION | 53 |
| DISCS | 12 | REFERENCES | 58 |
| USB | 17 | Maintenance | 58 |
| Android | 19 | More information | 58 |
| iPod/iPhone | 21 | Error message list | 62 |
| APPS | 23 | Troubleshooting..... | 62 |
| TUNER | 24 | Specifications..... | 65 |
| OTHER EXTERNAL COMPONENTS | 28 | | |
| Using the rear view camera..... | 28 | | |
| Using external audio/video players—AV-IN | 30 | | |

How to read this manual:

- Illustrations of KW-V420BT Region 2 are mainly used for explanation. The displays and panels shown in this manual are examples used to provide clear explanations of the operations. For this reason, they may be different from the actual displays or panels.
- This manual mainly explains operations using the buttons on the monitor panel and touch panel. For operations using the separately purchased remote controller (available only for KW-V420BT Region 2/ KW-V320BT Region 2/KW-V220BT Region 2), see page 51.
- < > indicates the various screens/menus/operations/settings that appear on the touch panel.
- [] indicates the buttons on the touch panel.
- **Indication language:** English indications are used for the purpose of explanation. You can select the indication language from the <Settings> menu. (Page 50)
- Updated information (the latest Instruction Manual, system updates, new functions, etc.) is available from <<http://www.jvc.net/cs/car/>>.

BEFORE USE

IMPORTANT

To ensure proper use, please read through this manual before using this product. It is especially important that you read and observe WARNINGS and CAUTIONS in this manual. Please keep the manual in a safe and accessible place for future reference.

⚠ **WARNINGS: (To prevent accidents and damage)**

- DO NOT install any unit or wire any cable in a location where;
 - it may obstruct the steering wheel and gearshift lever operations.
 - it may obstruct the operation of safety devices such as air bags.
 - it may obstruct visibility.
- DO NOT operate the unit while driving. If you need to operate the unit while driving, be sure to look around carefully.
- The driver must not watch the monitor while driving.

The marking of products using lasers



The label is attached to the chassis/case and says that the component uses laser beams that have been classified as Class 1. It means that the unit is utilizing laser beams that are of a weaker class. There is no danger of hazardous radiation outside the unit.

BEFORE USE

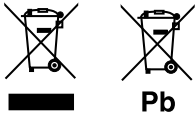

Information on Disposal of Old Electrical and Electronic Equipment and Batteries (applicable for countries that have adopted separate waste collection systems)

Products and batteries with the symbol (crossed-out wheeled bin) cannot be disposed as household waste.

Old electrical and electronic equipment and batteries should be recycled at a facility capable of handling these items and their waste byproducts. Contact your local authority for details in locating a recycle facility nearest to you.

Proper recycling and waste disposal will help conserve resources whilst preventing detrimental effects on our health and the environment.

Notice: The sign "Pb" below the symbol for batteries indicates that this battery contains lead.

For Israel

מידע בדבר השלכה לאשפה של ציוד חשמלי ואלקטרוני ישן וכן סוללות (רלוונטי למדינות שמשמשות במערכת איסוף אשפה מופרדת).

לא ניתן להשליך מוצרים וסוללות עם הסימון (פח אשפה עם X עליו) כאשפה ביתית רגילה. יש למחזר ציוד חשמלי ואלקטרוני ישן וכן סוללות במתקן המסוגל לטפל בפריטים כאלה ובתוצרי הלוואי שלהם.

צרו קשר עם הרשות המקומית לקבלת פרטים אודות מתקן המיחזור הקרוב אליכם. מיחזור והשלכה לאשפה נאותים יעזרו לשמר משאבים ולמנוע השפעות שליליות על בריאותנו ועל הסביבה.

שימו לב: הסימון Pb שמתחת לסימון עבור סוללות מציינ שהסוללה מכילה עופרת.

⚠ Cautions on the monitor:

- The monitor built into this unit has been produced with high precision, but it may have some ineffective dots. This is inevitable and is not considered defective.
- Do not expose the monitor to direct sunlight.
- Do not operate the touch panel using a ball-point pen or similar tool with a sharp tip.
Touch the buttons on the touch panel with your finger directly (if you are wearing a glove, take it off).
- When the temperature is very cold or very hot...
 - Chemical changes occur inside, causing malfunction.
 - Pictures may not appear clearly or may move slowly. Pictures may not be synchronized with the sound or picture quality may decline in such environments.

For safety...

- Do not raise the volume level too much, as this will make driving dangerous by blocking outside sounds, and may cause hearing loss.
- Stop the car before performing any complicated operations.

Temperature inside the car...

If you have parked the car for a long time in hot or cold weather, wait until the temperature in the car becomes normal before operating the unit.

🔧 How to reset your unit

If the unit fails to operate properly, press the reset button.

KW-V420BT



KW-V320BT

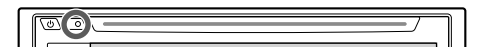

KW-V220BT



INITIAL SETTINGS

Initial setup

When you power on the unit for the first time or reset the unit, the initial setting screen appears.

- You can also change the settings on the **<Settings>** screen. (Page 48)

1 Perform the initial settings.

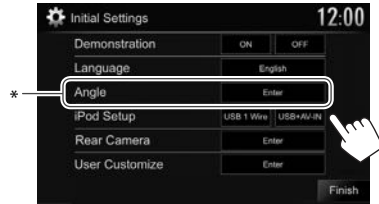

<Demonstration> Activate or deactivate the display demonstration. (Page 49)

<Language> Select the text language used for on-screen information. (Page 50)

- Set **<GUI Language>** to display the operation buttons and menu items in the selected language (**[Local]**) or English (**[English]**).

<Angle>* Adjust the panel angle.

<iPod Setup> Select the connection method of iPod/iPhone. (Page 21)

<Rear Camera> Configure the settings to display the picture from the connected rear view camera. (Page 28)

<User Customize> Change the display design.

(Page 44)

2 Finish the procedure.



The Home screen is displayed.

- * Only for KW-V420BT.

Clock settings

1 Display the Home screen.

On the monitor panel:

KW-V420BT **KW-V320BT** **KW-V220BT**

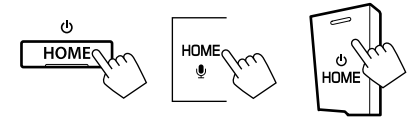

2 Display the **<Clock>** setting screen.

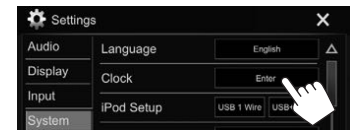
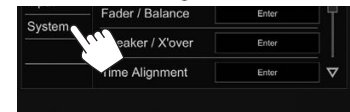
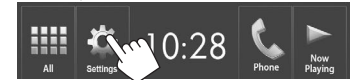

- You can also display the **<Clock>** setting screen by touching the clock area on the Home screen.

INITIAL SETTINGS

3 Set the clock time.



<Radio Data System> Synchronizes the clock time with FM Radio Data System.

<OFF> Sets the clock manually. (See below.)

When selecting **<OFF>**:

Adjust the hour (①), then adjust the minute (②).

- Press **[Reset]** to set the minute to "00".

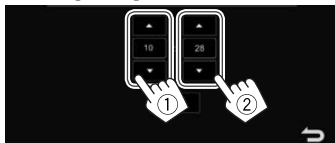

4 Finish the procedure.

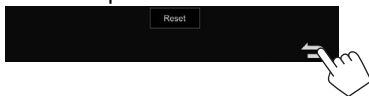

BASICS

Component names and functions

⚠ Caution on the volume setting:

Digital devices produce very little noise compared with other sources. Lower the volume before playing these digital sources to avoid damaging the speakers by sudden increase of the output level.

KW-V420BT

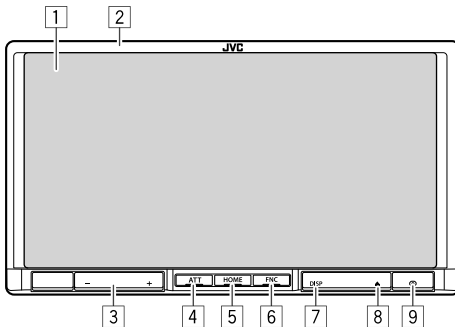

- 1 Screen (touch panel)
- 2 Monitor panel*
- 3 VOLUME \pm button
Adjusts the audio volume. (Page 7)
- 4 ATT button
Attenuates the sound. (Page 7)
- 5 HOME button
 - Displays the Home screen. (Press) (Page 9)
 - Turns on the power. (Press) (Page 7)
 - Turns off the power. (Hold) (Page 7)

- 6 FNC button
 - Pops up the short-cut menu. (Press) (Page 11)
 - Activates the voice dialing. (Hold) (Page 36)
- 7 DISP/DISP OFF button
 - Switches the screen. (Press)
 - The screen switched to depends on the **<Navigation Input>** setting (Page 49).
 - Turns off the screen. (Hold) (Page 8)
 - Turns on the screen. (Hold) (Page 8)
- 8 ▲ (Eject) button
Ejects the disc. (Tilts the monitor panel fully.) (Page 12)
- 9 Reset button
Resets the unit. (Page 3)

* You can change the color of the buttons on the monitor panel. (Page 44)

BASICS

KW-V320BT

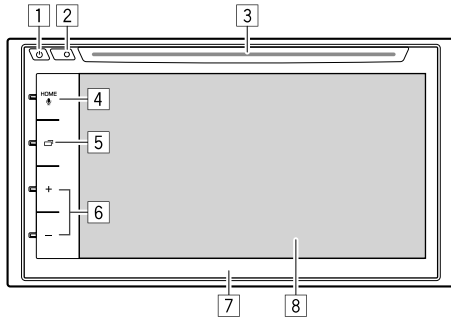

- 1 button
 - Turns on the power. (Press) (Page 7)
 - Turns off the power. (Hold) (Page 7)
 - Pops up the short-cut menu. (Press) (Page 11)
- 2 Reset button
 - Resets the unit. (Page 3)
- 3 Loading slot
- 4 HOME/ button
 - Displays the Home screen. (Press) (Page 9)
 - Activates the voice dialing. (Hold) (Page 36)
- 5 button
 - Switches the screen. (Press)
 - The screen switched to depends on the **<Navigation Input>** setting (Page 49).
 - Turns off the screen. (Hold) (Page 8)
 - Turns on the screen. (Hold) (Page 8)

- 6 Volume +/- button
 - Adjusts the audio volume. (Page 7)

- 7 Monitor panel*
- 8 Screen (touch panel)

* You can change the color of the buttons on the monitor panel. (Page 44)

KW-V220BT

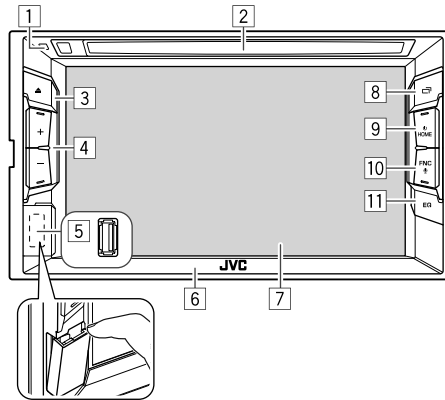

- 1 Reset button
 - Resets the unit. (Page 3)
- 2 Loading slot
- 3 (Eject) button
 - Ejects the disc. (Press) (Page 12)
- 4 Volume +/- button
 - Adjusts the audio volume. (Page 7)
- 5 USB input terminal (Page 55)
- 6 Monitor panel
- 7 Screen (touch panel)
- 8 button
 - Switches the screen. (Press)
 - The screen switched to depends on the **<Navigation Input>** setting (Page 49).
 - Turns off the screen. (Hold) (Page 8)
 - Turns on the screen. (Hold) (Page 8)
- 9 HOME/ button
 - Displays the Home screen. (Press) (Page 9)
 - Turns on the power. (Press) (Page 7)
 - Turns off the power. (Hold) (Page 7)
- 10 FNC/ button
 - Pops up the short-cut menu. (Press) (Page 11)
 - Activates the voice dialing. (Hold) (Page 36)
- 11 EQ button
 - Displays the **<Equalizer>** screen. (Page 40)

BASICS

Common operations

Turning on the power

KW-V420BT KW-V320BT KW-V220BT



Turning off the power

KW-V420BT KW-V320BT KW-V220BT

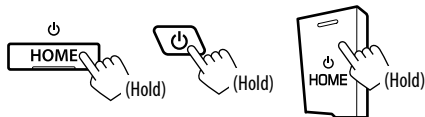

Adjusting the volume

To adjust the volume (00 to 35)

KW-V420BT

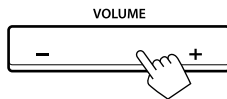

KW-V320BT

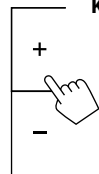

KW-V220BT

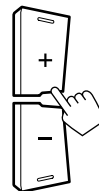

Press + to increase, and press – to decrease.

- Holding the button increases/decreases the volume continuously.

To attenuate the sound (only for KW-V420BT)



The ATT indicator lights up.

To cancel the attenuation: Press the same button again.

Adjusting the panel angle (only for KW-V420BT)

1 Display the <Angle Adjust> screen.

On the Home screen:

- Press [▽] repeatedly to change the page on the <Display> menu screen.

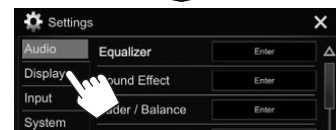

2 Select an angle (0 – 6).



- To set the current position as the power off position, select **[Memory]**.

BASICS

Turning off the screen

On the pop-up short-cut menu (Page 11):

Display the pop-up short-cut menu by pressing FNC (for KW-V420BT/KW-V220BT) or \cup (for KW-V320BT) on the monitor panel, then select **[Display OFF]**.



On the monitor panel:

KW-V420BT

KW-V320BT

KW-V220BT

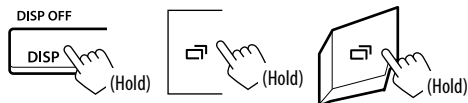

To turn on the screen: Press and the hold the same button, or touch the display.

Turning on/off the AV source

You can activate the AV function by selecting a source on the Home screen.



To select a source not displayed on the Home screen: Press **[All]**. (Page 10)

To turn off the AV source:

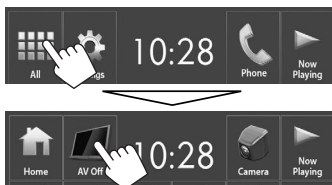

Common screen operations

Common screen descriptions

You can display other screens any time to change the source, show the information, or change the settings, etc.

Source control screen

Performs source playback operations.

- The operation buttons and information displayed vary depending on the selected source.

KW-V420BT/KW-V220BT



KW-V320BT

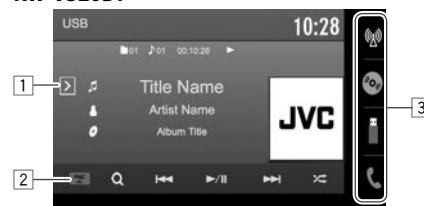

Common operating buttons:

- 1 Displays the other operation button window.*
- 2 Only for KW-V320BT: FNC button
Pops up the short-cut menu. (Page 11)
- 3 Only for KW-V320BT: Source buttons
Changes the playback source. (Page 10)
 - The source buttons shown on the Home screen is displayed. (Page 9)

* Does not appear when there are no other operation buttons other than those currently shown on the source control screen.

BASICS

Gesture control on the source control screen:

You can also control playback by moving your finger on the touch panel as follows (for some sources, the gesture control is not available).

- **Sliding the finger towards up/down:** Functions same as pressing [-] [+].
- **Sliding the finger towards left/right:** Functions same as pressing [<◀] [▶].
- **Moving your finger clockwise or counter-clockwise:** increases/decreases the volume.

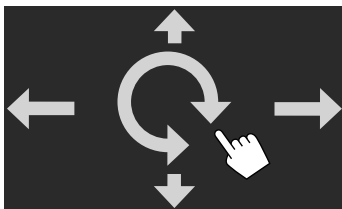

Home screen

Displays the source control screen and settings screen.

- You can arrange the items to display on the Home screen. (Page 45)

KW-V420BT/KW-V220BT

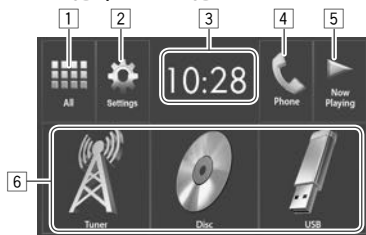

Common operating buttons:

- 1 Displays all playback sources and items. (Page 10)
- 2 Displays the <Settings> screen. (See the right column.)
- 3 Displays the <Clock> setting screen. (Page 4)
- 4 Displays the phone control screen. (Page 35)
- 5 Displays the source currently played back.
- 6 Changes the playback source. (Page 11)

KW-V320BT



Common operating buttons:

- 1 Changes the playback source. (Page 11)
- 2 Displays the <Clock> setting screen. (Page 4)
- 3 ▲ (Eject) button: Ejects the disc. (Press) (Page 12)
- 4 C button: Displays the <User Customize> screen. (Page 44)
- 5 ⚙ button: Displays the <Settings> screen. (See the right column.)
- 6 4x4 grid button: Displays all playback sources and items. (Page 10)
- 7 [Phone] button: Displays the phone control screen. (Page 35)

<Settings> screen

Changes the detailed settings. (Page 48)

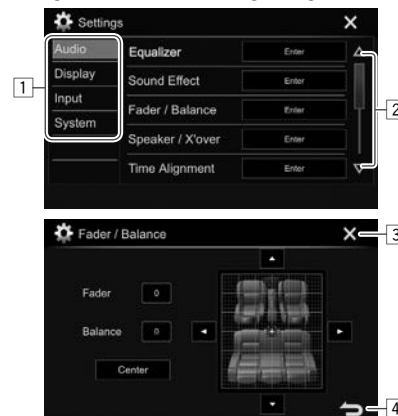

Common operating buttons:

- 1 Selects the menu category.
- 2 Changes the page.
- 3 Closes the current setting screen and returns to the current source control screen.
- 4 Returns to the previous screen.

BASICS

Touch screen operations

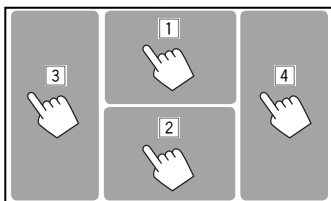

- 1 Displays the video control menu while playing a video.



- 2 Displays the source control screen while playing a video.

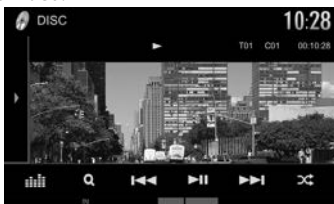

- The operation buttons disappear when the screen is touched or when no operation is done for about 5 seconds.

- 3 Goes to the previous chapter/track.*
4 Goes to the next chapter/track.*

* Not available for video from an external component.

Selecting the playback source

On the Home screen:



- [AV Off]** Turns off the AV source. (Page 8)
- [Camera]** Switches to a camera connected to the rear view camera input. (Page 28)
- [Now Playing]** Displays the source currently played back.
- [Tuner]** Switches to the radio broadcast. (Page 24)
- [Disc]** Plays a disc. (Page 12)
- [USB]** Plays files on a USB device. (Page 17)
- [iPod]** Plays an iPod/iPhone. (Page 21)
- [Android™]** Plays an Android device. (Page 19)
- [BT Audio]** Plays a Bluetooth audio player. (Page 37)

[AV-IN]* Switches to an external component connected to the iPod/AV-IN input terminal. (Page 30)

[Apps] Switches to the App screen from the connected iPod touch/iPhone/Android device. (Page 23)

To return to the Home screen



* Selectable only when <iPod Setup> is set to **[USB 1 Wire]**. (Page 21)

BASICS

❑ Selecting the playback source on the Home screen



- You can change the items to display on the Home screen. (Page 45)

Using the pop-up short-cut menu

While displaying the source control screen, you can jump to the other screen from the pop-up short-cut menu.

- 1 Display the pop-up short-cut menu.
KW-V420BT KW-V320BT KW-V220BT



- Only for KW-V320BT: You can also display the pop-up short-cut menu by pressing [FNC] on the source control screen.

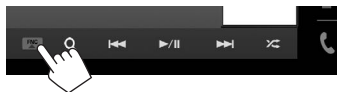

- 2 Select an item to jump to.



For KW-V420BT/KW-V220BT

- [Screen Adjustment]** Displays the picture adjustment screen. (Page 43)
- [Display OFF]** Turns off the screen. (Page 8)
- [Camera]** Displays the picture from the rear view camera. (Page 28)
- [Settings]** Displays the <Settings> screen. (Page 48)
- [Current Source]** Displays the current source control screen.

For KW-V320BT

- [Phone]** Displays the phone control screen. (Page 35)
- [Voice]** Activates the voice dialing. (Page 36)
- [EQ]** Displays the <Equalizer> screen. (Page 40)
- [Picture Adjust]** Displays the picture adjustment screen. (Page 43)
- [User Customize]** Displays the <User Customize> screen. (Page 44)

To close the pop-up menu: Touch the screen anywhere other than the pop-up short-cut menu.

DISCS

Playing a disc

- If a disc does not have a disc menu, all tracks on it will be played repeatedly until you change the source or eject the disc.
- For playable disc types/file types, see page 59.

Inserting a disc

Insert a disc with the label side facing up.

KW-V420BT

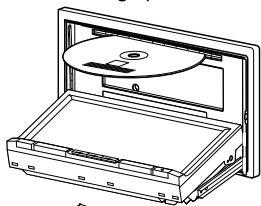
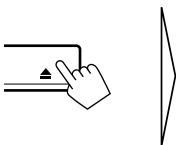

KW-V320BT

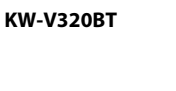

KW-V220BT



The source changes to **"DISC"** and playback starts.

- The IN indicator lights up while a disc is inserted.

- If "⊘" appears on the screen, the unit cannot accept the operation you have tried to do.
 - In some cases, without showing "⊘," operations will not be accepted.
- When playing back a multi-channel encoded disc, the multi-channel signals are downmixed to stereo.

Ejecting a disc

KW-V420BT



KW-V220BT



KW-V320BT

Press [▲] on the Home screen or **"DISC"** source control screen.

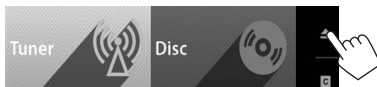

- When removing a disc, pull it horizontally.
- You can eject a disc when playing another AV source.
- If the ejected disc is not removed within 15 seconds, the disc is automatically inserted again into the loading slot to protect it from dust.

Closing the monitor panel (only for KW-V420BT)

After removing the disc, press ▲ on the monitor panel. The monitor panel closes.

Playback operations

When the operation buttons are not displayed on the screen, touch the area shown on the illustration.

- To change settings for video playback, see page 43.

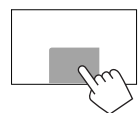

Indications and buttons on the source control screen

For video playback

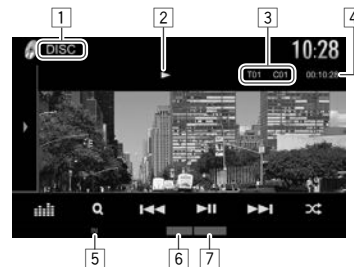

Playback information

- The information displayed on the screen differs depending on the type of disc/file being played back.
- 1 Media type
 - 2 Playback status
 - 3 Current playback item information (title no./chapter no./folder no./file no./track no.)
 - 4 Playing time
 - 5 IN indicator
 - 6 Playback mode (Page 15)
 - 7 File type

DISCS

Operation buttons

- Available buttons on the screen and operations differ depending on the type of disc/file being played back.

[▶]/[⏏]* Displays the other operation button window.

- To hide the window, press [◀]/[⏏]*.

[📊] Displays the <Equalizer> screen. (Page 40)

[Q] Displays the folder/track list. (Page 14)

[◀◀] [▶▶] • Selects a chapter/track. (Press)
• Reverse/forward search. (Hold)
• Plays in slow-motion during pause. (Hold)

[▶||] Starts/pauses playback.

[⏮] [⏭] Selects Random playback mode. (Page 15)

[📁] [➕] Selects a folder.

[↺] Selects Repeat playback mode. (Page 15)

[■] Stops playback.

[MODE] Changes the settings for disc playback on the <DISC Mode> screen. (Page 16)

- To display all available operation buttons, press [▶]/[⏏]* to display the other operation button window.

* The appearance of the buttons differs depending on the model:
[▶] or [◀] for KW-V420BT/KW-V220BT/[⏏] or [⏏] for KW-V320BT.

For audio playback

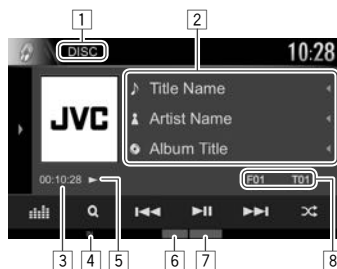

Playback information

- The information displayed on the screen differs depending on the type of disc/file being played back.

- 1 Media type
- 2 Track/file information
 - Pressing [◀] scrolls the text if not all of the text is shown.
- 3 Playing time
- 4 IN indicator
- 5 Playback status
- 6 Playback mode (Page 15)
- 7 File type
- 8 Current playback item information (folder no./file no./track no.)

Operation buttons

- Available buttons on the screen and operations differ depending on the type of disc/file being played back.

[▶]/[⏏]* Displays the other operation button window.

- To hide the window, press [◀]/[⏏]*.

[📊] Displays the <Equalizer> screen. (Page 40)

[Q] Displays the folder/track list. (Page 14)

[◀◀] [▶▶] • Selects a track. (Press)
• Reverse/forward search. (Hold)

[▶||] Starts/pauses playback.

[■] Stops playback.

[⏮] [⏭] Selects Random playback mode. (Page 15)

[📁] [➕] Selects a folder.

[↺] Selects Repeat playback mode. (Page 15)

[MODE] Changes the settings for disc playback on the <DISC Mode> screen. (Page 16)

- To display all available operation buttons, press [▶]/[⏏]* to display the other operation button window.

* The appearance of the buttons differs depending on the model:
[▶] or [◀] for KW-V420BT/KW-V220BT/[⏏] or [⏏] for KW-V320BT.

DISCS

❑ Selecting a folder/track on the list

1

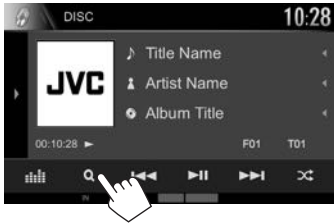

2 Select the folder (①), then the item in the selected folder (②).

- Repeat the procedure until you select the desired track.

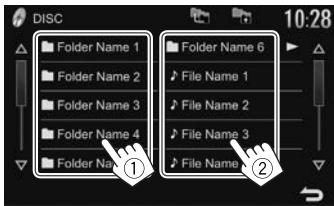

- You can change the page to display more items by pressing [▲]/[▼].
- Press [⏪] to return to the root folder.
- Press [⏩] to return to the upper layer.
- If you want to play all tracks in the folder, press [▶] on the right of the desired folder.

❑ Video menu operations

You can display the video menu screen during video playback.

- The operation buttons disappear when the screen is touched or when no operation is done for about 5 seconds.

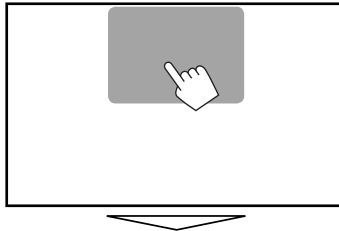

For video playback except VCD

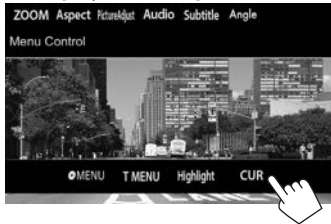

- Available buttons on the screen and operations differ depending on the type of disc/file being played back.

[MENU]
[T MENU]
[Highlight]

Displays the disc menu (DVD).
Displays the disc menu (DVD).
Switches to the direct disc menu mode. Touch the target item to select.

- To restore the screen, press [↩].

[CUR]

Displays the menu/scene selection screen.

- [▲][▼][◀▶]: Selects an item.
- [Enter]: Confirms the selection.
- [Return]: Returns to the previous screen.

[ZOOM]

Displays the picture size selection screen. (Page 44)

[Aspect]

Selects the aspect ratio. (Page 43)

[PictureAdjust]

Displays the picture adjustment screen. (Page 43)

[Audio]

Selects the audio type.

[Subtitle]

Selects the subtitle type.

[Angle]

Selects the view angle.

DISCS

For VCD



- [MENU]** Displays the disc menu.
- [Audio]** Selects the audio channel (ST: stereo, L: left, R: right).
- [Direct]** Displays/hides the direct selection buttons. (See the right column.)
- [Return]** Displays the previous screen or menu.
- [ZOOM]** Displays the picture size selection screen. (Page 44)
- [Aspect]** Selects the aspect ratio. (Page 43)
- [PictureAdjust]** Displays the picture adjustment screen. (Page 43)

To select a track directly on a VCD

- When playing a VCD with PBC activated, stop playback to deactivate the PBC function, then use the direct selecting buttons to select a track number.

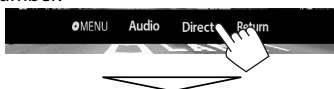

- When you enter a wrong number, press **[DIR/CLR]** to delete the last entry.

Selecting playback mode

To select Repeat playback mode

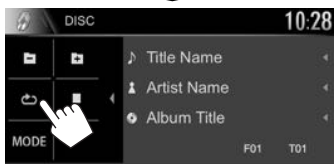
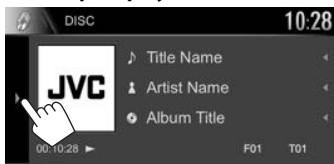

To select Random playback mode



- The location of the buttons differ depending on the type of disc/file being played back.
 - When **[REPEAT]** is not displayed, display the other operation button window by pressing **[▶]/[◀]***.
- Available playback modes differ depending on the type of disc/file being played back.
- You cannot activate the repeat mode and the random mode at the same time.
- Each time you press the button, the playback mode changes. (The corresponding indicator lights up.)
 - Available items differ depending on the type of disc/file being played back.

- CC** Repeats current chapter.
- TT** Repeats current title/program.
- CT** Repeats current track.
- FO** Repeats all tracks of the current folder.
- FOX** Randomly plays all tracks of the current folder, then tracks of the next folders.
- XX** Randomly plays all tracks.

To cancel Repeat/Random playback: Press the button repeatedly until the indicator disappears.

* The appearance of the buttons differs depending on the model: **[▶]** for KW-V420BT/KW-V220BT/**[◀]** for KW-V320BT.

DISCS

Settings for disc playback—<DISC Mode>

1

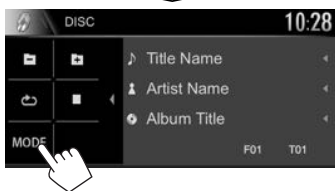
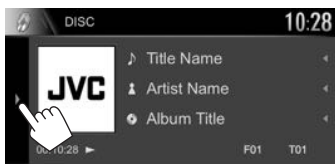

2



- Available items shown on the <DISC Mode> screen differ depending on the type of disc/file being played back.

Setting items

| | |
|--------------------------------------|--|
| <Menu Language> | Select the initial disc menu language. (Initial: English for KW-V420BT Region 2/KW-V320BT Region 2/ KW-V220BT Region 2/ Русский for KW-V420BT Region 5/KW-V320BT Region 5/KW-V220BT Region 5) (Page 61) |
| <Subtitle Language> | Select the initial subtitle language or turn subtitles off (Off). (Initial: English for KW-V420BT Region 2/ KW-V320BT Region 2/KW-V220BT Region 2/ Русский for KW-V420BT Region 5/KW-V320BT Region 5/ KW-V220BT Region 5) (Page 61) |
| <Audio Language> | Select the initial audio language. (Initial: English for KW-V420BT Region 2/KW-V320BT Region 2/ KW-V220BT Region 2/ Русский for KW-V420BT Region 5/KW-V320BT Region 5/ KW-V220BT Region 5) (Page 61) |
| <Dynamic Range Control> | You can change the dynamic range while playing using Dolby Digital software. <ul style="list-style-type: none"> • Wide: Select this to enjoy a powerful sound at a low volume level with its full dynamic range. • Normal: Select this to reduce the dynamic range a little. • Dialog (Initial): Select this to reproduce movie dialog more clearly. |

| | |
|-----------------------------|---|
| <Down Mix> | When playing back a multi-channel disc, this setting affects the signals reproduced through the front and/or rear speakers. <ul style="list-style-type: none"> • Dolby Surround: Select this to enjoy multi-channel surround sound by connecting an amplifier compatible with Dolby Surround. • Stereo (initial): Normally select this. |
| <Screen Ratio> | Select the monitor type to watch a wide screen picture on the external monitor. 16:9 (Initial) 4:3 LB 4:3 PS  |
| <File Type>* | Select the playback file type when a disc contains different types of files. <ul style="list-style-type: none"> • Audio: Plays back audio files. • Still Image: Plays back picture files. • Video: Plays back video files. • Audio&Video (initial): Plays back audio files and video files. |

* For playable file types, see page 58.
If the disc contains no files of the selected type, the existing files are played in the following priority: audio, video, then still picture. You can change these settings only while playback is stopped.

USB

Connecting a USB device

You can connect a USB mass storage class device such as a USB memory, Digital Audio Player etc. to the unit.

- For details about connecting USB devices, see page 55.
- You cannot connect a computer or portable HDD to the USB input terminal.
- For playable file types and notes on using USB devices, see page 60.

When a USB device is connected...

The source changes to “USB” and playback starts.

- All tracks in the USB device will be played repeatedly until you change the source.

To disconnect the USB device safely:

- Press [▲], then disconnect the USB device after “No Device” appears.

Playback operations

When the operation buttons are not displayed on the screen, touch the area shown on the illustration.

- To change settings for video playback, see page 43.

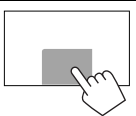

Indications and buttons on the source control screen

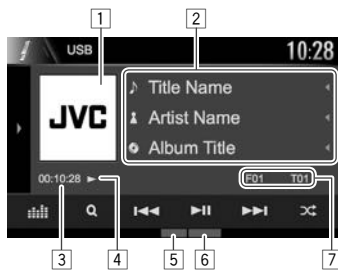

Playback information

- The information displayed on the screen differs depending on the type of file being played back.
- 1 Jacket picture (Shown while playing if the file has tag data that includes the jacket picture)
 - 2 Track/file information
 - Pressing [◀] scrolls the text if not all of the text is shown.
 - 3 Playing time
 - 4 Playback status
 - 5 Playback mode (See the right column.)
 - 6 File type
 - 7 Current playback item information (folder no./file no.)

Operation buttons

- Available buttons on the screen and operations differ depending on the type of file being played back.
- [▶]/[⏮]*1 Displays the other operation button window.
- To hide the window, press [◀]/[⏪]*1.
- [🔊] Displays the <Equalizer> screen. (Page 40)

- [🔍] Displays the folder/track list. (Page 18)
- [◀◀] [▶▶] • Selects a track. (Press)
• Reverse/forward search. (Hold)
- [▶||] Starts/pauses playback.
- [🔀] Selects random playback mode.*2 *3
- **FO** [🔀]: Randomly plays all tracks/files in the folder.
 - [🔀]: Randomly plays all tracks/files.
- [📁] [➕] Selects a folder.
- [🔄] Selects repeat playback mode.*2 *3
- [🔄]: Repeats the current track/file.
 - **FO** [🔄]: Repeats all tracks/files in the current folder.
- [▲] Disconnects the USB device safely.
- [MODE] Changes the settings for USB playback on the <USB Mode> screen. (Page 18)

- To display all available operation buttons, press [▶]/[⏮]*1 to display the other operation button window.

*1 The appearance of the buttons differs depending on the model: [▶] or [◀] for KW-V420BT/KW-V220BT/[⏮] or [⏪] for KW-V320BT.

*2 To cancel random or repeat mode, press the button repeatedly until the indicator disappears.

*3 You cannot activate the repeat mode and the random mode at the same time.

USB

❑ Settings for USB playback—<USB Mode>

1

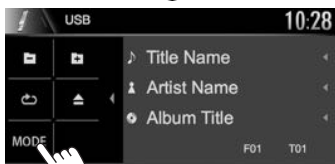
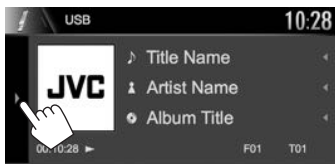

2

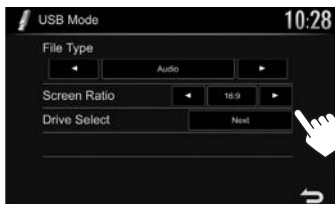

| | |
|-----------------------------|--|
| <File Type>* | <p>Select the playback file type when a disc contains different types of files.</p> <ul style="list-style-type: none"> • Audio: Plays back audio files. • Still Image: Plays back picture files. • Video: Plays back video files. • Audio&Video (initial): Plays back audio files and video files. |
| <Screen Ratio> | <p>Select the monitor type to watch a wide screen picture on the external monitor.</p> <p>16:9 (Initial) 4:3 LB 4:3 PS</p>  |
| <Drive Select> | <p>Switches between internal memory and the memory source of the connected device (such as mobile phone). Press [Next].</p> |

* For playable files, see page 58. If the USB device contains no files of the selected type, the existing files are played in the following priority: audio, video, then still picture.

❑ Selecting a folder/track on the list

1

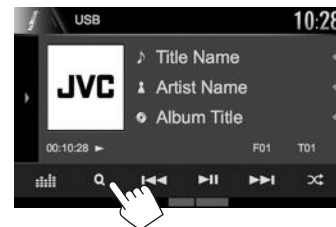

2 Select the folder (①), then the item in the selected folder (②).

- Repeat the procedure until you select the desired track.



- You can change the page to display more items by pressing [Δ]/[∇].
- Press [\leftarrow] to return to the root folder.
- Press [\uparrow] to return to the upper layer.
- If you want to play all tracks in the folder, press [\rightarrow] on the right of the desired folder.

Android

Preparation

❑ Installing JVC Music Play

Install the Android™ application JVC Music Play on your Android device beforehand.

- When a compatible Android device is connected, "Press [VIEW] to install JVC MUSIC PLAY APP" is shown on the Android device. Follow the instructions to install the application. You can also install the latest version of the JVC Music Play application on your Android device before connecting.

About JVC Music Play

- This unit supports the Android™ application JVC Music Play.
- When you use JVC Music Play, you can search for audio files by Genre, Artist, Album, Playlist, and Song.
- JVC Music Play is available on the following web site: <<http://www.jvc.net/cs/car/>>

❑ Connecting an Android device

Connect an Android device with a cable.

- For details about connecting Android devices, see page 55.

Compatible Android device

- This unit supports Android OS 4.1 and above.
- Some Android devices (with OS 4.1 and above) may not fully support Android Open Accessory (AOA) 2.0.
- If the Android device supports both mass storage class device and AOA 2.0, this unit always plays back via AOA 2.0 as priority.
- For more information and the latest compatible list, see: <<http://www.jvc.net/cs/car/>>

❑ Starting playback

- 1 Start JVC Music Play on your Android device.
- 2 Select "Android™" as the source. (Page 10)

Playback operations

❑ Indications and buttons on the source control screen

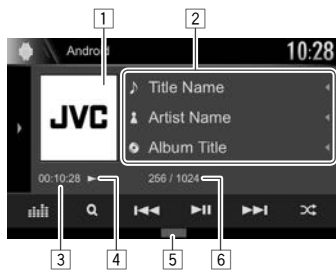

Playback information

- 1 Artwork (Shown if the song contains artwork)
- 2 Track information
 - Pressing [◀] scrolls the text if not all of the text is shown.
- 3 Playing time
- 4 Playback status
- 5 Playback mode (See the right column.)
- 6 Track no./Total track number

Operation buttons

- [▶]/[⏮]*1 Displays the other operation button window.
 - To hide the window, press [◀]/[⏮]*1.
- [≡] Displays the <Equalizer> screen. (Page 40)
- [Q] Displays the track list. (Page 20)
- [◀◀] [▶▶]• Selects a track. (Press)
 - Reverse/forward search. (Hold)
- [▶||] Starts/pauses playback.
- [⌂] Selects random playback mode.*2
 - ⌂: Randomly plays all tracks.
 - ⌂ Album: Randomly plays all tracks in the current album.
- [↺] Selects repeat playback mode.
 - ↺ ①: Repeats the current track.
 - ↺ All: Repeats all tracks.
 - ↺: Cancels the repeat mode.
- [MODE] Changes the settings for Android playback on the <Android Mode> screen. (Page 20)

- To display all available operation buttons, press [▶]/[⏮]*1 to display the other operation button window.

*1 The appearance of the buttons differs depending on the model: [▶] or [◀] for KW-V420BT/KW-V220BT/[▶] or [◀] for KW-V320BT.

*2 To cancel random mode, press the button repeatedly until the indicator disappears.

Android

❑ Selecting a track from the menu

1

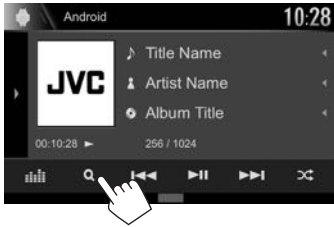

2 Select a category (①), then a desired item (②).

- Select an item in each layer until you reach and select the desired file.
- You can change the page to display more items by pressing [▲]/[▼].
- Press [⏪] to return to the top layer.
- Press [⏩] to return to the upper layer.



❑ Settings for playback on the Android device—<Android Mode>

1

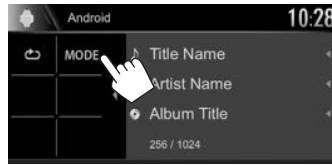
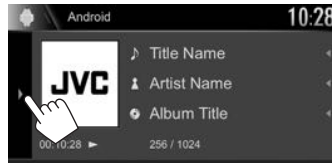

2

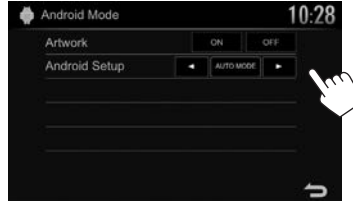

| | |
|-----------------|---|
| <Artwork> | Shows/hides artwork of the Android device. |
| <Android Setup> | <ul style="list-style-type: none">• AUTO MODE: Controls from the unit (using the JVC Music Play application).• AUDIO MODE: Controls other media player applications from the Android device (without using the JVC Music Play application).<ul style="list-style-type: none">– You can play/pause or skip files from the unit. |

iPod/iPhone

Preparation

❑ Connecting iPod/iPhone

- For details about connecting iPod/iPhone, see page 55.
- For playable iPod/iPhone types, see page 60.

Connect your iPod/iPhone according to your purpose or the type of iPod/iPhone.

• To listen to music:

- For Lightning connector models: Use USB Audio cable for iPod/iPhone—KS-U62.
- For 30-pin connector models: Use 30-pin to USB cable (accessory of iPod/iPhone).

• To watch video and listen to music (only for 30-pin connector models): Use USB Audio and Video cable for iPod/iPhone—KS-U59 (optional accessory).

- For Lightning connector models: You cannot watch video with KS-U59.

❑ Selecting the connection method of iPod/iPhone

- 1 Turn off the AV source. (Page 8)
- 2 Display the <System> setting screen.
On the Home screen:

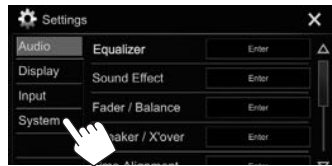

3

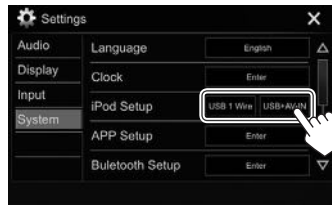

[USB 1 Wire] Select this when the iPod/iPhone is connected using KS-U62 (optional accessory) or 30-pin to USB cable (accessory of iPod/iPhone).

[USB+AV-IN] Select this when the iPod/iPhone is connected using KS-U59 (optional accessory).

❑ Selecting preference settings for iPod/iPhone playback—<iPod Mode>

1

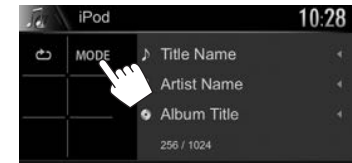
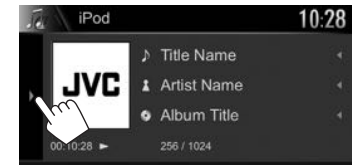

2

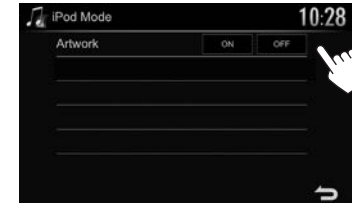

<Artwork>

Shows/hides artwork of iPod.

Playback operations

When the operation buttons are not displayed on the screen, touch the area shown on the illustration.

- To change settings for video playback, see page 43.

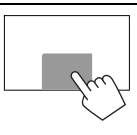

Indications and buttons on the source control screen



Playback information

- 1 Artwork (Shown if the song contains artwork)
- 2 Song/video information
 - Pressing [◀] scrolls the text if not all of the text is shown.
- 3 Playing time
- 4 Playback status
- 5 Playback mode (See the right column.)
- 6 File type
- 7 Track no./Total track number

Operation buttons

- [▶]/[⏮]*¹ Displays the other operation button window.
 - To hide the window, press [◀]/[⏮]*¹.
- [📊] Displays the **<Equalizer>** screen. (Page 40)
- [Q] Displays the audio/video file list. (See the right column.)
- [◀◀] [▶▶]
 - Selects a track. (Press)
 - Reverse/forward search. (Hold)
- [⏸] Starts/pauses playback.
- [🔄] Selects random playback mode.*²
 - 🔄: Functions the same as Shuffle Songs.
 - 🔄 **Album**: Functions the same as Shuffle Albums.
- [🔄] Selects repeat playback mode.
 - 🔄 ①: Functions the same as Repeat One.
 - 🔄 **All**: Functions the same as Repeat All.
 - 🔄: Cancels the repeat mode.
- [MODE] Changes the settings for iPod/iPhone playback on the **<iPod Mode>** screen. (Page 21)

- To display all available operation buttons, press [▶]/[⏮]*¹ to display the other operation button window.

- *¹ The appearance of the buttons differs depending on the model: [▶]/[⏮]*¹ for KW-V420BT/KW-V220BT/[⏮] or [▶] for KW-V320BT.
- *² To cancel random mode, press the button repeatedly until the indicator disappears.

Selecting an audio/video file from the menu

- 1
- 2 Select the menu (🎵: audio or 📺: video) (①), a category (②), then a desired item (③).
 - Select an item in each layer until you reach and select the desired file.
 - You can change the page to display more items by pressing [△]/[▽].
 - Press [🏠] to return to the top layer.
 - Press [📄] to return to the upper layer.
 - If you want to play all tracks in the item, press [▶] on the right of the desired item.

Audio menu:

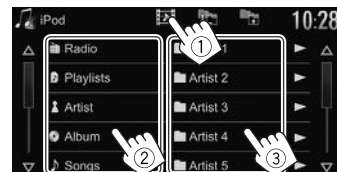

Video menu:

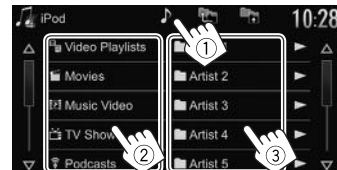

- Available categories differ depending on the type of your iPod/iPhone.

APPS

You can use an App of the connected iPod touch/iPhone/Android on this unit.

- For Apps you can use on this unit, visit <http://www.jvc.net/cs/car/>.

Preparation

- 1 Connect the iPod touch/iPhone/Android.
 - **For Android:** Connect the Android device via Bluetooth. (Page 31)
 - **For iPod touch/iPhone:** Connect iPod touch/iPhone with a cable. (Page 55)
 - Be sure to select the appropriate connection method of iPod touch/iPhone on **<iPod Setup>**. (Page 21)
 - You cannot watch video when connecting a Lightning connector model.
- 2 Select the iPod touch/iPhone/Android device to use on the **<APP Setup>** screen. (Page 39)

When connecting the device for the first time, the setup screen (for connection, etc.) appears. Follow the procedure on the setup screen to configure the settings.

Using an App

When the operation buttons are not displayed on the screen, touch the screen to show them.

- To change settings for video playback, see page 43.

❑ Playback operations

- 1 Start the App on your iPod touch/iPhone/Android.
- 2 Select **"Apps"** as the source. (Page 10)

❑ Operation buttons on the source control screen

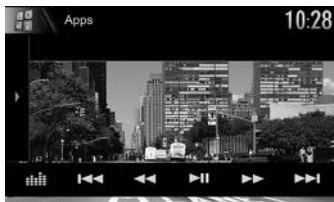

- [▶]/[⏏]* Displays the other operation button window.
 - To hide the window, press [◀]/[⏏]*. (Page 40)
- [📊] Displays the **<Equalizer>** screen. (Page 40)
- [◀◀] [▶▶] Selects an audio/video file.
- [◀◀] [▶▶] Reverse/forward search.
- [▶▶] Starts/pauses playback.
- [▶] Starts playback.
- [⏏] Pauses playback.

[0°/S] Switches the device between iPod touch/iPhone connected with a cable and Android device connected via Bluetooth.

- To display all available operation buttons, press [▶]/[⏏]* to display the other operation button window.
- You can operate some functions of the App on the touch panel.
- You can also play back the audio (for iPod touch/iPhone/Android device) and video (for iPod touch/iPhone) on the stated devices itself, instead of the unit.

* The appearance of the buttons differs depending on the model: [▶]/[⏏] for KW-V420BT/KW-V220BT/[⏏] or [⏏] for KW-V320BT.

❑ Switching to the Apps screen while listening to another source (when using iPod/iPhone)

- Select [iPhone] for **<Navigation Input>** beforehand. (Page 49)

KW-V420BT **KW-V320BT** **KW-V220BT**

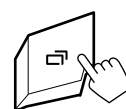
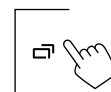
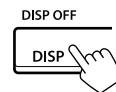

TUNER

Listening to the radio

Indications and buttons on the source control screen

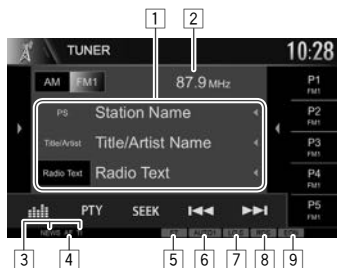

Tuner reception information

- 1 Text information
 - Pressing [◀] scrolls the text if not all of the text is shown.
 - Pressing [Radio Text] switches the information between Radio Text, Radio Text Plus, and PTY code.
- 2 The station frequency currently tuned in
- 3 Standby reception indicators (NEWS/TI)
- 4 AF indicator
- 5 ST/MONO indicator
 - The ST indicator lights up when receiving an FM stereo broadcast with sufficient signal strength.
- 6 Seek mode
- 7 LO.S indicator (Page 25)
- 8 RDS indicator: Lights up when receiving a Radio Data System station.
- 9 EON indicator: Lights up when a Radio Data System station is sending EON signals.

Operation buttons

- [▶]/[Σ]^{*1} Displays the other operation button window.
 - To hide the window, press [◀]/[Σ]^{*1}.
- [AM] Selects the AM band.
- [FM] Selects the FM band.
▶ FM1 → FM2 → FM3
- [◀]^{*2} Displays the preset station window. (Page 26)
 - To hide the window, press [▶]^{*2}.
- [P1] – [P5]
 - Selects a stored station. (Press)
 - Stores the current station. (Hold)
- [Equalizer] Displays the <Equalizer> screen. (Page 40)
- [PTY]^{*3} Enters PTY search mode. (Page 26)
- [SEEK] Changes the seek mode.
 - **AUTO1**: Auto Search
 - **AUTO2**: Tunes in stations in the memory one after another.
 - **MANU**: Manual Search
- [◀◀] [▶▶] Searches for a station.
 - The search method differs according to the selected seek mode. (See above.)
- [SSM ↓]^{*3} Presets stations automatically. (Hold) (Page 25)
- [MONO]^{*3} Activates/deactivates monaural mode for better FM reception. (Stereo effect will be lost.)
 - The MONO indicator lights up while monaural mode is activated.
- [TI]^{*3} Activates/deactivates TI standby reception mode. (Page 26)

[MODE]^{*3} Changes the settings for tuner reception on the <Tuner Mode> screen. (Pages 25 and 27)

- To display all available operation buttons, press [▶]/[Σ]^{*1} to display the other operation button window.

^{*1} The appearance of the buttons differs depending on the model: [▶] or [◀] for KW-V420BT/KW-V220BT/[Σ] or [Σ] for KW-V320BT.

^{*2} Only for KW-V420BT/KW-V220BT.

^{*3} Appears only when FM is selected as the source.

TUNER

❑ Tuning in only FM stations with strong signals—Local Seek

- 1 Display the <Tuner Mode> screen.

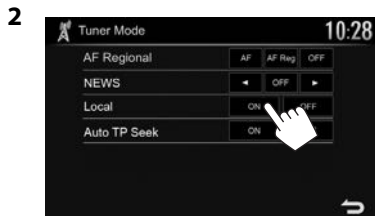
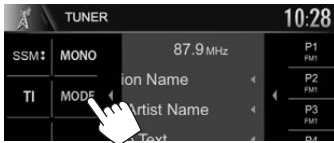
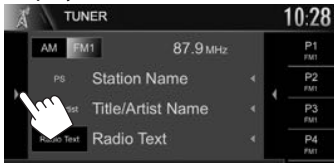

The unit tunes in only to stations with sufficient signal strength. The LO.S indicator lights up.

To deactivate Local Seek: Press [OFF].

Presetting stations

❑ Storing stations in the memory

You can preset 5 stations for each band.

Automatic presetting—SSM (Strong-station Sequential Memory)

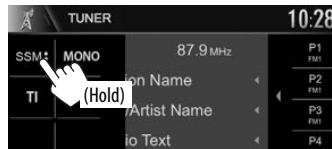
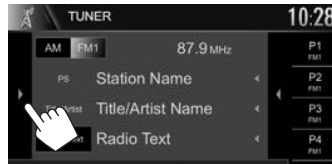

The local stations with the strongest signals are found and stored automatically.

Manual presetting

- 1 Tune in to a station you want to preset. (Page 24)
- 2 Select a preset number.



The station selected in step 1 is stored.

TUNER

❑ Selecting a preset station

For KW-V420BT/KW-V220BT:

- 1 Select the band (①), then display the preset station window (②).

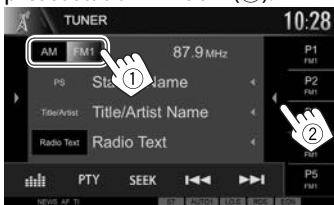

- You can also select a preset station by pressing [P1] – [P5].

- 2 Select a preset station.

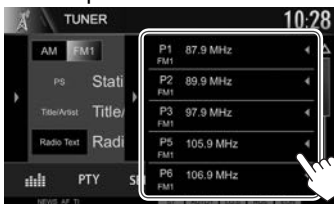

- Pressing [◀] scrolls the text if not all of the text is shown.
- To hide the window list, press [▶].

For KW-V320BT:

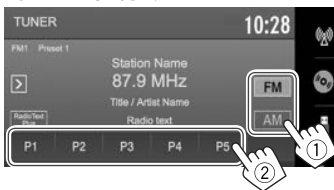

FM Radio Data System features

❑ Searching for FM Radio Data System programs—PTY Search

You can search for your favorite programs being broadcast by selecting the PTY code.



- 2 Select a PTY code.

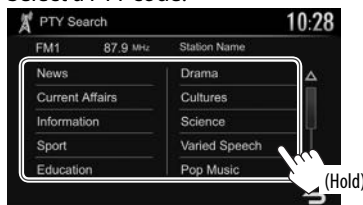

- You can change the page to display more items by pressing [▲]/[▼].

PTY Search starts.

If there is a station broadcasting a program of the same PTY code as you have selected, that station is tuned in.

- Only English/Spanish/French/German/Dutch/Portuguese are available for the text language here. If another language has been selected in <Language> (Page 50), the text language is set to English.

❑ Activating/deactivating TI/News Standby Reception

TI Standby Reception

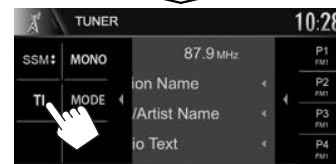
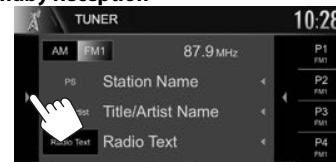

The unit is in standby to switch to Traffic Information (TI) if available. (The TI indicator lights up in white.)

- If the TI indicator is lit in orange, tune into another station providing Radio Data System signals.

To deactivate TI Standby Reception: Press [TI]. (The TI indicator turns off.)

- The volume adjustment for Traffic Information is automatically memorized. The next time the unit switches to Traffic Information, the volume is set to the previous level.

TUNER

News Standby Reception

1 Display the <Tuner Mode> screen.
(Page 25)



<00min> – Activate News Standby Reception
<90min> (the NEWS indicator lights up).

Select the period of time to
disable interruption.

<OFF> Deactivate the function.

- The volume adjustment while receiving News is automatically memorized. The next time the unit switches to News, the volume is set to the previous level.

Tracing the same program—Network-Tracking Reception

When driving in an area where FM reception is not sufficient enough, this unit automatically tunes in to another FM Radio Data System station of the same network, possibly broadcasting the same program with stronger signals.

- When shipped from the factory, Network-Tracking Reception is activated.

To change the Network-Tracking Reception setting

1 Display the <Tuner Mode> screen.
(Page 25)



[AF] Switch to another station. The program may differ from the one currently received (the AF indicator lights up).

[AF Reg] Switch to another station broadcasting the same program (the AF indicator lights up).

[OFF] Deactivate the function.

- The RDS indicator lights up when the Network-Tracking Reception is activated and an FM Radio Data System station is found.

Automatic TI station seek—Auto TP Seek

When traffic information station reception is poor, the unit automatically searches for another station that can be received better.

To activate Auto TP Seek

1 Display the <Tuner Mode> screen.
(Page 25)

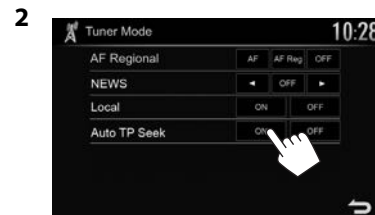

To deactivate Auto TP Seek: Press [OFF].

OTHER EXTERNAL COMPONENTS

Using the rear view camera

- To connect a rear view camera, see page 56.
- To use a rear view camera, a REVERSE lead connection is required. (Page 54)

□ Settings for the rear view camera

- 1 Display the <Input> settings screen.
On the Home screen:

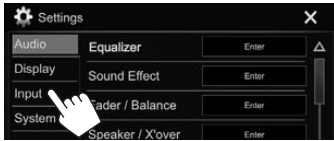
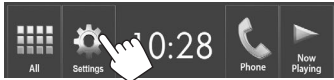

- 2 Display the <Rear Camera> screen.



3

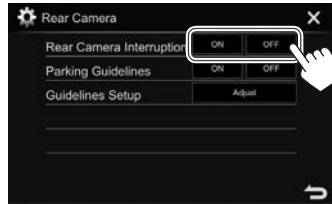

- [ON] Displays the picture from the rear view camera when you shift the gear to the reverse (R) position.
- [OFF] Select this when no camera is connected

□ Displaying the rear view camera screen

To display the picture from the rear view camera
The rear view screen is displayed when you shift the gear to the reverse (R) position.

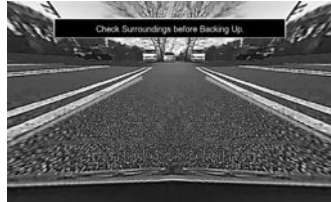

- To remove the caution message, touch the screen.

To display the picture from the rear view camera manually



- Only for KW-V420BT/KW-V220BT: You can also display the picture from the rear view camera by selecting [Camera] on the pop-up short-cut menu (Page 11).

To exit the camera screen

Press HOME on the monitor panel.

- You can also exit the camera screen by touching the area shown below.

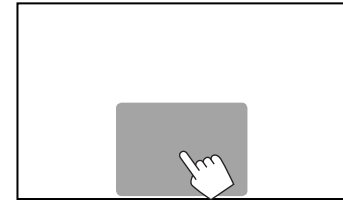

OTHER EXTERNAL COMPONENTS

To adjust the picture

While the camera screen is displayed...

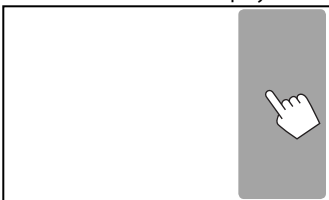

- The picture adjustment menu is displayed. (Page 43)

To close the picture adjustment menu, touch the same area again.

❑ Using the parking guidelines on the rear view screen

You can display parking guidelines to enable easier parking when you shift the gear to the reverse (R) position.

Displaying the parking guidelines

- 1 Display the <Input> settings screen.

On the Home screen:

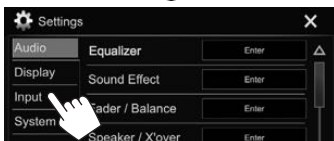
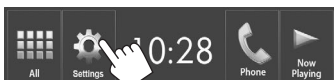

- 2 Display the <Rear Camera> screen.

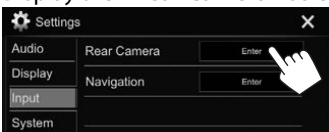

- 3

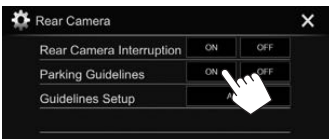

To deactivate: Select [OFF] for <Parking Guidelines>.

- You can also display the parking guidelines by touching the area shown below. To close the parking guidelines, touch the same area again.

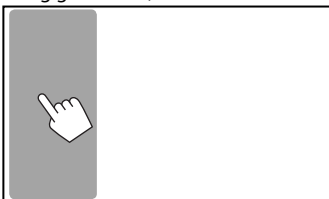

Adjusting the parking guidelines

Adjust the parking guidelines according to the size of the car, parking space and so on.

- Install the rear view camera in the appropriate position according to the instructions supplied with the rear view camera.
- When adjusting the parking guidelines, make sure to use the parking brake to prevent the car from moving.

- 1 Display the <Rear Camera> screen. (See the far left column.)
- 2 Display the parking guidelines adjustment screen.

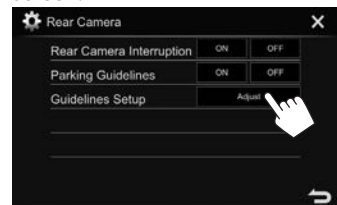

- 3 Adjust the parking guidelines by selecting the [Initialize] mark (1), then adjusting the position of the selected [Initialize] mark (2).

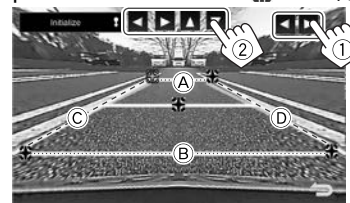

Make sure that (A) and (B) are horizontally parallel, and that (C) and (D) are the same length.

- Press and hold [Initialize] for 2 seconds to set all the [Initialize] marks to the initial default position.

OTHER EXTERNAL COMPONENTS

Using external audio/video players—AV-IN

When the operation buttons are not displayed on the screen, touch the area shown on the illustration.

- To change settings for video playback, see page 43.

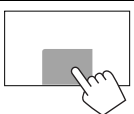

Starting playback

Preparation:

“AV-IN” cannot be selected when <iPod Setup> is set to [USB+AV-IN]. Be sure to select [USB 1 Wire] for <iPod Setup> beforehand. (Page 21)

- 1 Connect an external component to the iPod/AV-IN input terminal. (Page 56)
- 2 Select “AV-IN” as the source. (Page 10)
- 3 Turn on the connected component and start playing the source.



Changing the AV-IN name

You can change the AV-IN name displayed on the “AV-IN” source control screen.

- 1 Display the <VIDEO Mode> screen.



- 2 Select an AV-IN name.

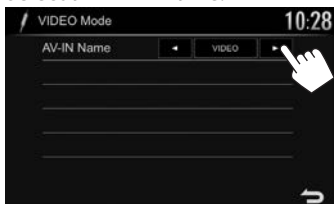

- This setting does not affect the source name displayed on the Home screen.

BLUETOOTH

Information for using Bluetooth® devices



Bluetooth is a short-range wireless radio communication technology for mobile devices such as mobile phones, portable PCs, and other devices. Bluetooth devices can be connected without cables and communicate with each other.

Notes

- While driving, do not perform complicated operations such as dialing numbers, using the phone book, etc. When you perform these operations, stop your car in a safe place.
- Some Bluetooth devices may not connect to this unit depending on the Bluetooth version of the device.
- This unit may not work for some Bluetooth devices.
- Connecting conditions may vary depending on your environment.
- For some Bluetooth devices, the device is disconnected when the unit is turned off.

About mobile phones compatible with Phone book Access Profile (PBAP)

If your mobile phone supports PBAP, you can display the following items on the touch panel screen when the mobile phone is connected.

- Phone book
- Dialed calls, received calls, and missed calls (up to 10 entries in total)

Connecting Bluetooth devices

❑ Registering a new Bluetooth device

When you connect a Bluetooth device to the unit for the first time, pair the unit and the device. Pairing allows Bluetooth devices to communicate with each other.

- The pairing method differs depending on the Bluetooth version of the device.
 - For devices with Bluetooth 2.1: You can pair the device and the unit using SSP (Secure Simple Pairing) which only requires confirmation.
 - For devices with Bluetooth 2.0: You need to enter a PIN code both on the device and unit for pairing.
- Once the connection is established, it is registered in the unit even if you reset the unit. Up to 10 devices can be registered in total.
- Two devices for Bluetooth phone and one for Bluetooth audio can be connected at a time.
- To use the Bluetooth function, you need to turn on the Bluetooth function of the device.
- To use the registered device, you need to connect the device to the unit. (Page 33)

Auto pairing

When <Auto Pairing> is set to [ON], iOS devices (such as iPhone) are automatically paired when connected via USB. (Page 38)

Pairing a Bluetooth device using SSP (for Bluetooth 2.1)

When the Bluetooth device is compatible with Bluetooth 2.1, a pairing request is sent from an available device.

- 1 Search for the unit (“Car Multimedia”) from your Bluetooth device.
- 2 Confirm the request both on the device and the unit.



- Press [Cancel] to reject the request.

BLUETOOTH

Pairing a Bluetooth device using a PIN code (for Bluetooth 2.0)

- 1 Display the <Bluetooth Setup> screen.
On the Home screen:

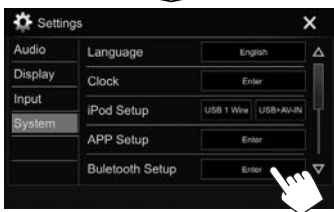
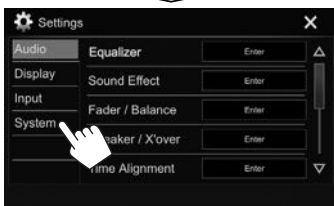

- You can also display the <Bluetooth Setup> screen by pressing [**Bluetooth**] on the phone control screen. (Page 35)



- 2 Change the PIN code.
 - If you wish to skip changing the PIN code, go to step 3.
 - The PIN code is initially set to "0000".
 - The maximum number of digits in the PIN code is 15.

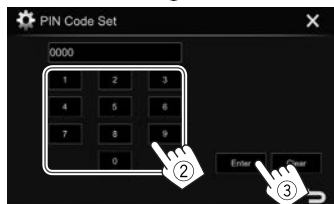
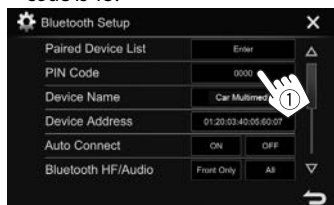

- Press [**Clear**] to delete the last entry.
- 3 Search for the unit ("**Car Multimedia**") from your Bluetooth device.

- 4 Select the unit ("**Car Multimedia**") on your Bluetooth device.
 - If a PIN code is required, enter "0000" (initial).

When pairing is complete, the device is listed on the <Paired Device List>.



- To use the paired device, connect the device on the <Paired Device List>. (Page 33)

BLUETOOTH

❑ Connecting/disconnecting a registered Bluetooth device

Two devices can be connected simultaneously.

1 Display the <Bluetooth Setup> screen.
(Page 32)

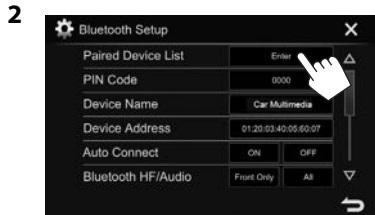

3 Select the device you want to connect (①), then press [Connection] (②).

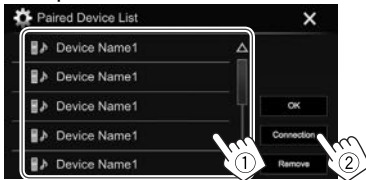

4 Select [ON] (to connect) or [OFF] (to disconnect) for the target (①), then display the <Paired Device List> screen (②).

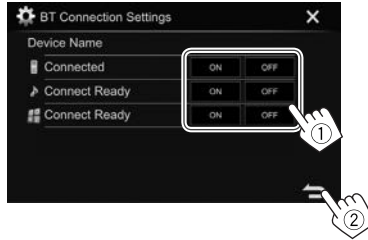

📱: Mobile phone

🎵: Audio device

🪟: Device for using Apps

- The status is shown as follows:
 - “Connecting”: Connection is in progress.
 - “Connected”: A connection has been established.
 - “Connect Ready”: A connection can be established.
 - “Disconnecting”: Disconnection is in progress.
 - “Disconnected”: No connection is established.

5 Connect the selected device.



- When a Bluetooth mobile phone is connected, the signal strength and battery level are displayed when the information is acquired from the device.

❑ Deleting a registered Bluetooth device

1 Display the <Bluetooth Setup> screen.
(Page 32)

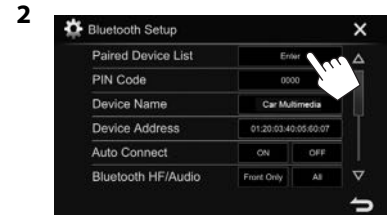

3 Select a device to delete (①), then press [Remove] (②).

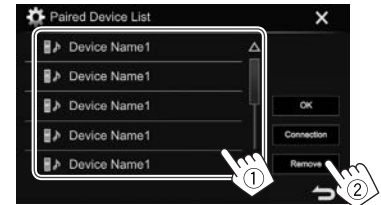

A confirmation message appears. Press [Yes].

BLUETOOTH

Using a Bluetooth mobile phone

❑ Receiving a call

When a call comes in...

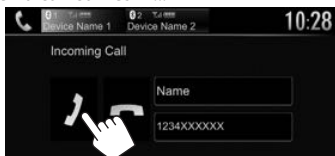

- Call information is displayed if acquired.
- Phone operation is not available while the picture from the rear view camera is displayed. (Page 28)

To reject a call



When <Auto Answer> is set to [ON] (Page 38)
The unit answers incoming calls automatically.

❑ Ending a call

While talking...



❑ Adjusting the volume of calls/earpiece/microphone

While talking...



- You can adjust the volume level between -10 to 10 (initial: -4).
- Use the monitor panel to adjust the call/earpiece volume. (Page 7)

❑ Switching between handsfree mode and phone mode

While talking...



Each time you press the button, the talking method is switched (📞↔️📞: handsfree mode / 📞↔️📞: phone mode).

❑ Adjusting the noise reduction/echo cancel level

While talking...



- **To adjust the noise reduction volume (between -5 to 5, initial: 0)** : Adjust <NR LEVEL>.
- **To adjust the echo volume (between -5 to 5, initial: 0)**: Adjust <EC LEVEL>.

BLUETOOTH

❑ Sending text during a call

You can send text during a call using the DTMF (Dual Tone Multi Frequency) function.

While talking...



❑ Switching between two connected devices

When 2 devices are connected, you can change the device to use.

While using a Bluetooth mobile phone, select the device you want to use.



- The active device is highlighted.

❑ Making a call

- 1 Display the phone control screen. On the Home screen:

For KW-V420BT/KW-V220BT:



For KW-V320BT:

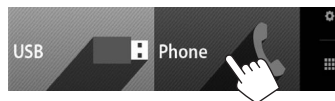

- Only for KW-V320BT: You can also display the phone control screen by selecting **[Phone]** on the pop-up short-cut menu (Page 11).
- 2 Select a method to make a call.



- 1 From the call history*
- 2 From the phone book*
- 3 From the preset list
- 4 Direct number entry
- 5 Voice dialing

- You can display the **<Bluetooth Setup>** screen by pressing [**⚙**].

- * When the mobile phone is not compatible with Phone Book Access Profile (PBAP), the call history and the phone book are not displayed.

From the call history/phone book/preset list

1



- 1 From the call history (missed calls/received calls/dialed calls)
- 2 From the phone book
- 3 From the preset list

2 Select the target (①), then make a call (②).



- You can change the page to display more items by pressing [**△**]/[**▽**].

Continued on the next page...

BLUETOOTH

- To use the A to Z search in the phone book:

1



2 Select the initial.

- If the initial character is a number, press [1,2,3...] and then select the number.

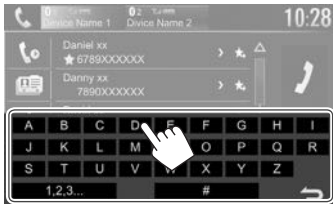

3 Select a phone number from the list.



- To display other phone numbers:
When the phone book list is displayed, you can switch between phone numbers if several phone numbers are registered for the same contact (up to 10 phone numbers per contact).

1 Switch the phone number.



- The phone number switches each time [>] is pressed.

2 Select a phone number to call.



Direct number entry

You can enter up to 31 numbers.

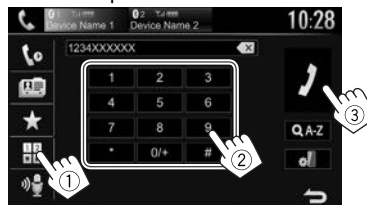

- Press [X] to delete the last entry.
- Press and hold [0/+] to add "+" to the phone number.

Voice dialing

- Available only when the connected mobile phone has a voice recognition system.

1 Activate voice dialing.
On the phone control screen:



- When iPhone is connected, Siri is activated.
- You can also activate voice dialing by holding FNC/ (for KW-V420BT/KW-V220BT) or HOME/ (for KW-V320BT) on the monitor panel.

2 Say the name of the person you want to call.

- If the unit cannot find the target, the following screen appears. Press [Start], then say the name again.



To cancel voice dialing: Press [Cancel].

BLUETOOTH

❑ Presetting phone numbers

You can preset up to 5 phone numbers.

1 Display the phone control screen.
(Page 35)



3 Select a phone number to preset.



The preset list is displayed.

4 Select a preset number to store into.



- To display the preset list, press [★] on the phone control screen. (Page 35)

Using the Bluetooth audio player

- To register a new device, see page 31.
- To connect/disconnect a device, see page 33.

❑ Indications and buttons on the source control screen



- The operation buttons, indications and information displayed on the screen differ depending on the connected device.

Playback information

- 1 Tag data (current track title/artist name/album title)*1
 - Pressing [◀] scrolls the text if not all of the text is shown.
- 2 The signal strength and battery level (Appear only when the information is acquired from the device.)
- 3 Playing time*1
- 4 Playback status*1

Operation buttons

- [▶]/[⏮]*2 Displays the other operation button window.
 - To hide the window, press [◀]/[⏮]*2.
- [📶] Displays the <Equalizer> screen. (Page 40)
- [📄] Displays the track list. (Page 38)
- [◀] [▶]*1 • Selects a track. (Press)
 - Reverse/forward search.*1 (Hold)
- [▶] Starts playback.
- [⏸] Pauses playback.
- [🔀]*3 Selects random playback mode.*3
- [🔄]*3 Selects repeat playback mode.*3
- [⚙️] Displays the <Bluetooth Setup> screen. (Page 38)

- To display all available operation buttons, press [▶]/[⏮]*2 to display the other operation button window.

*1 Available only for devices compatible with AVRCP 1.3.

*2 The appearance of the buttons differs depending on the model:
[▶]/[⏮] for KW-V420BT/KW-V220BT/[▶]/[⏮] or [◀]/[⏮] for KW-V320BT.

*3 The random and repeat functions vary depending on the Bluetooth audio device.

BLUETOOTH

❑ Selecting an audio file from the menu

1



2 Select a category (①), then a desired item (②).



- Select an item in each layer until you reach and select the desired file.
- You can change the page to display more items by pressing [▲]/[▼].
- Press [⏪] to return to the upper layer.
- If you want to play all tracks in the folder, press [▶] on the right of the desired folder.

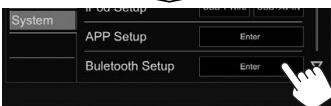

- You can also display the <Bluetooth Setup> screen by pressing [⚙️] on the phone control screen (Page 35) or [⚙️] on the "BT Audio" source control screen (Page 37).

2 Configure the Bluetooth settings.

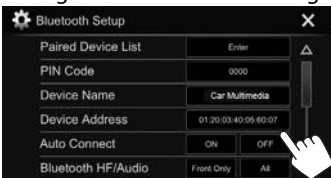

❑ Setting items

| | |
|----------------------|--|
| <Paired Device List> | Press [Enter] to show the list of registered devices. You can connect a device or delete registered devices. (Page 33) |
| <PIN Code> | Changes the PIN code of the unit. (Page 32) |
| <Device Name> | Shows the device name to be shown on the Bluetooth device — Car Multimedia . |

| | |
|----------------------|---|
| <Device Address> | Shows the device address of the unit. |
| <Auto Connect> | <ul style="list-style-type: none"> • ON (Initial): A connection is automatically established with the last connected Bluetooth device when the unit is turned on. • OFF: Cancels. |
| <Bluetooth HF/Audio> | Select the speakers used for Bluetooth (both phone and audio player). <ul style="list-style-type: none"> • Front Only: Front speakers only. • All (Initial): All speakers. |
| <Auto Answer> | <ul style="list-style-type: none"> • ON: The unit answers the incoming calls automatically after 5 seconds. • OFF (Initial): The unit does not answer the calls automatically. Answer the calls manually. |
| <Auto Pairing> | <ul style="list-style-type: none"> • ON (Initial): Establishes pairing automatically with the connected iOS device (such as iPhone) even if the Bluetooth function is deactivated on the device. (Auto pairing may not work for some devices depending on the iOS version.) • OFF: Cancels. |
| <Initialize> | Hold [Enter] to reset all settings you have made for using Bluetooth mobile phones and Bluetooth audio players. |

Settings for Bluetooth devices

You can change various settings for using Bluetooth devices on the <Bluetooth Setup> screen.

1 Display the <Bluetooth Setup> screen. On the Home screen:

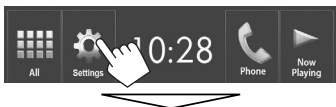

SETTINGS

Settings for using applications of iPod touch/iPhone/Android

Before using applications of iPod touch/iPhone/Android, select the device to use.

When connecting the device for first time, the setup screen (for connection, etc.) appears. Follow the procedure on the setup screen to configure the settings.

Preparation:

- **For Android:** Connect the Android device via Bluetooth. (Page 31)
- **For iPod touch/iPhone:**
 - Connect iPod touch/iPhone with a cable. (Page 55)
 - Select the connection method of iPod touch/iPhone on **<iPod Setup>**. (Page 21)

- 1 Display the **<APP Setup>** screen. On the Home screen:

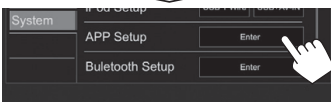
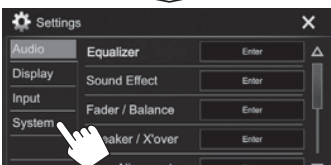
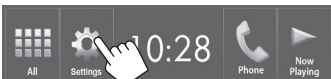

- 2 Select the device type (①), then press **[OK]** (②).

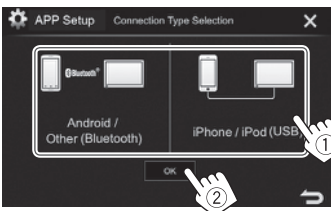

- When selecting **[iPhone/iPod (USB)]**, the setting is complete.

- 3 When selecting **[Android/Other (Bluetooth)]** as the device type: Select the Android device (①), then press **[OK]** to connect (②).

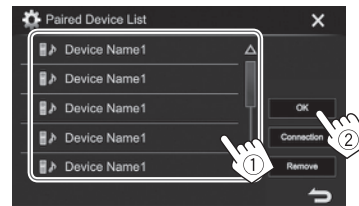

- You can change the page to display more items by pressing [▲]/[▼].

SETTINGS

Sound adjustment

Using the sound equalization

- The adjustments are memorized for each source until you adjust the sound again. If the source is a disc, the adjustments are stored for each of the following categories.
 - DVD/VCD
 - CD
 - DivX/MPEG1/MPEG2/MP3/WMA/WAV/AAC
- You cannot adjust the sound when the unit is in standby.

Selecting a preset sound mode

- 1 Display the **<Equalizer>** screen.
On the Home screen:

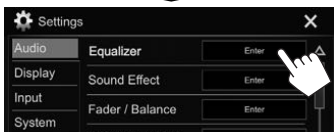
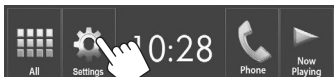

- 2 Select a sound mode.



- You can change the page to display more items by pressing [Δ]/[∇].
- You can also display the **<Equalizer>** screen by pressing [grid] on the source control screen.

Storing your own adjustments—Adjusting the sound precisely

- 1 Select a sound mode. (See the left column.)
- 2 Select a band and adjust the level of the selected band.
 - You can adjust the level by dragging the slider or using [\blacktriangle]/[\blacktriangledown].
 - Repeat this step to adjust the level of other bands.

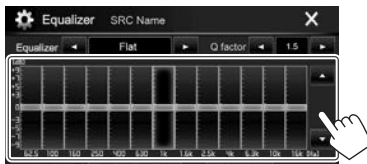

The adjustments are stored and **<User>** is activated.

- 3 Adjust the sound.

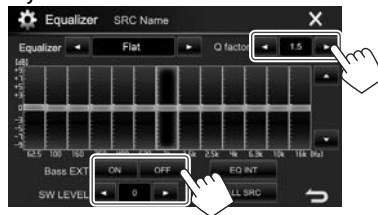

- <Q factor>** Adjusts the width of the frequency.
- <Bass EXT>** Activates (**[ON]**)/deactivates (**[OFF]**) bass.
- <SW LEVEL>** Adjusts subwoofer level.*

- To apply the adjusted equalizer to all playback sources, press [**ALL SRC**], then press [**OK**] to confirm.
- To clear the adjustment, press [**EQ INT**].

* Not adjustable when **<None>** is selected for subwoofer on the **<Speaker Select>** screen. (Page 41)

Setting the crossover network mode

Select the appropriate crossover network mode according to the speaker system (2-way speaker system or 3-way speaker system).

- 1 Turn off the AV source. (Page 8)
- 2 Display the **<X'over Network>** screen.
 - For KW-V420BT/KW-V220BT: Press FNC and volume + on the monitor panel at the same time.
 - For KW-V320BT: Press power and volume + on the monitor panel at the same time.
- 3 Select the crossover network mode.

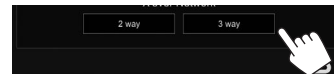

- [2 way]** Select this when connecting speakers in a 2-way system (front/rear).
- [3 way]** Select this when connecting speakers in a 3-way system (tweeter/mid range/woofer).

A confirmation message appears. Press [**Yes**].

SETTINGS

❑ Setting the speakers—car type, speaker size and crossover frequency

Preparation:

Select the appropriate crossover network mode beforehand. (Page 40)

- 1 Display the **<Car Setting>** screen.
On the Home screen:

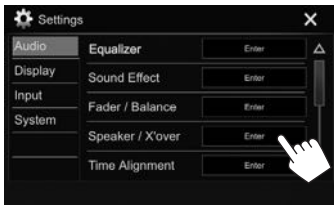
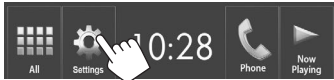

- 2 Select a car type (1), select the location of the speakers (2)*1, then display the **<Speaker Select>** screen (3).



- 3 Select the speaker type (1), select the size of the selected speaker (2), then display the **<X'over>** screen (3).

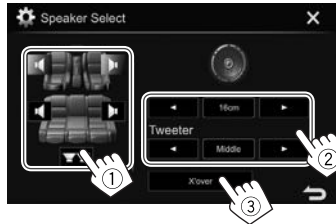

- When a speaker is not connected, select **<None>**.
- When setting the front speakers, also select the speaker size for **<Tweeter>**.

- 4 Adjust the crossover frequency of the selected speaker.

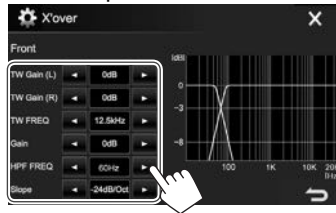

- <TW Gain (L)>/<TW Gain (R)>** Adjusts the output volume of the tweeter (left/right).*2*3
- <TW FREQ>** Adjusts the crossover frequency for the tweeter.*2*3
- <Gain>** Adjusts the output volume of the selected speaker.
- <HPF FREQ>** Adjusts the crossover frequency for the front or rear speakers (high pass filter).*4
- <LPF FREQ>** Adjusts the crossover for the subwoofer (low pass filter).*5
- <Slope>** Adjusts the crossover slope.*6
- <Phase>** Selects the phase for the subwoofer.*5

*1 Speaker location selection is available only when **<X'over Network>** is set to **[2 way]**. (Page 40)

*2 Appears only when the front speakers are selected.

*3 Adjustable only when **<Tweeter>** is set to **<Small>**, **<Middle>**, or **<Large>** on the **<Speaker Select>** screen.

*4 Appears only when the front/tweeter or rear/mid range speakers are selected.

*5 When **<X'over Network>** is set to **[2 way]** (Page 40): Appears only when the subwoofer is selected.

*6 Not adjustable when **<HPF FREQ>** or **<LPF FREQ>** is set to **<Through>**.

SETTINGS

❑ Adjusting the Digital Time Alignment (DTA)

Make fine adjustments to the delay time of the speaker output to create a more suitable environment for your vehicle.

- 1 Display the <Time Alignment> screen.
On the Home screen:

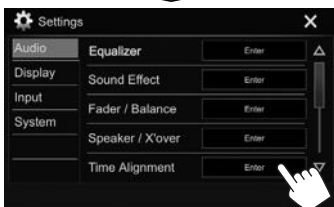
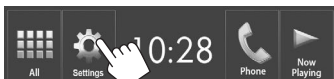

- 2 Select the listening position (<All>, <Front L>, <Front R> or <Front All>*).

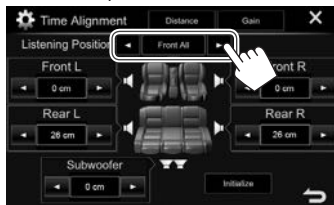

- 3 Select an item to make an adjustment.

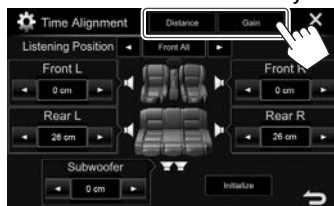

[Distance] Adjusts the Digital Time Alignment (DTA) value.

[Gain] Adjusts the output volume of the selected speaker.

- 4 Adjust each speaker setting.

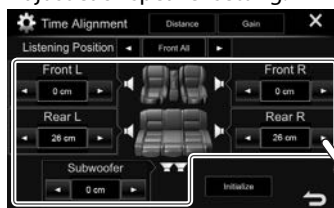

- To determine the adjustment value, see the right column.
- To initialize the setting value, press [Initialize].

* <Front All> is selectable only when <X'over Network> is set to [2 way]. (Page 40)

Determining the value for <Position DTA> adjustment

If you specify the distance from the center of the currently set listening position to every speaker, the delay time will be automatically computed and set.

- ① Determine the center of the currently set listening position as the reference point.
- ② Measure the distances from the reference point to the speakers.
- ③ Calculate the differences between the distance of the furthest speaker and other speakers.
- ④ Set the DTA value calculated in step ③ for individual speakers.
- ⑤ Adjust gain for individual speakers.

Example: When <Front All> is selected as the listening position

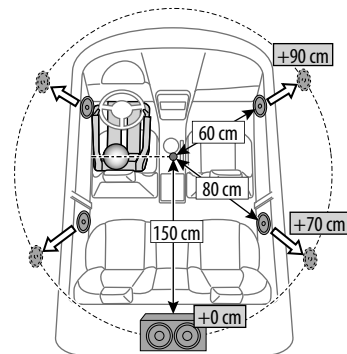

SETTINGS

Adjustment for video playback

□ Adjusting the picture

You can adjust the picture quality.

1 Display the picture adjustment screen.

On the source control screen:

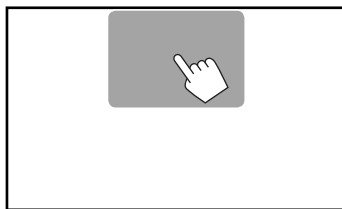

2 Select **[DIM ON]** (dimmer on) or **[DIM OFF]** (dimmer off) (1), then adjust the picture (2).



- <Bright>** Adjusts the brightness. (-15 to +15)
- <Contrast>** Adjusts the contrast. (-10 to +10)
- <Black>** Adjusts the blackness. (-10 to +10)
- <Color>** Adjusts the color. (-10 to +10)
- <Tint>** Adjusts the tint. (-10 to +10)
- <Sharpness>** Adjusts the sharpness. (-2 to +2)

- You can also display the picture adjustment screen by selecting **[Screen Adjustment]** (for KW-V420BT/KW-V220BT)/**[Picture Adjust]** (for KW-V320BT) on the pop-up short-cut menu (Page 11).

□ Changing the aspect ratio

You can change the aspect ratio for video playback.

1 Display the aspect ratio selection screen.

On the source control screen:

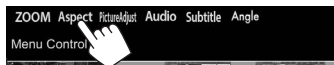
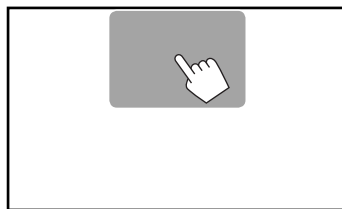

2 Select the aspect ratio.



<FULL>* For 16:9 original pictures

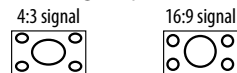

<JUST> For viewing 4:3 pictures naturally on the wide screen



<Normal>* For 4:3 original pictures



<Auto> For "DISC"/"USB" only: The aspect ratio is automatically selected to match the incoming signals.

- * While DivX is played back with **<Screen Ratio>** set to **[16:9]** (Page 16 for discs/Page 18 for USB), the aspect ratio may not set correctly.

SETTINGS

❑ Zooming the picture

You can zoom the picture (<FULL>, <Zoom1> to <Zoom3>).

- When <Aspect> is set to <JUST> or <Auto> (Page 43), the picture is zoomed with the aspect ratio of the <FULL> setting.

1 Display the magnification level selecting screen.

On the source control screen:

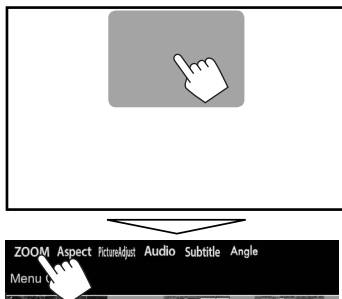

2 Change the magnification (①), then move the zooming frame (②).



- The zoom function cannot be used for some video sources.

Changing the display design

You can change the background and panel color.

1 Display the <User Customize> screen. On the Home screen:

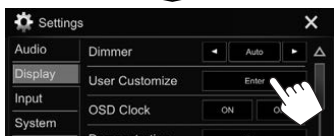
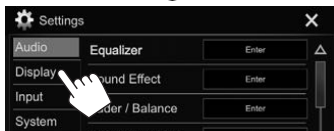

- Only for KW-V320BT: You can also display the <User Customize> screen by selecting [User Customize] on the pop-up short-cut menu (Page 11).

2 Only for KW-V420BT/KW-V320BT: Select an item to change (background design: [Background]/panel color: [Panel Color]).



3 Select a background/panel color*1.

To select a background

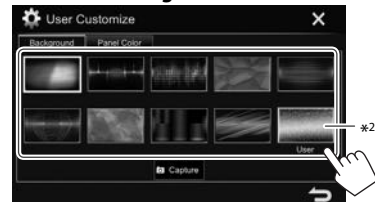

To select a panel color*1

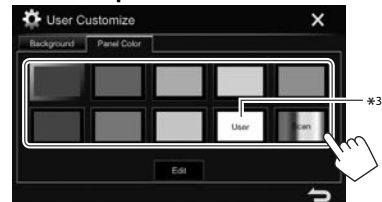

- Selecting [Scan] changes the illumination color gradually.

*1 Panel color is selectable only for KW-V420BT/KW-V320BT.

*2 Store your own scene beforehand. (Page 45)

*3 Store your own color adjustment beforehand. (Page 45)

SETTINGS

❑ Making your own color adjustment (only for KW-V420BT/KW-V320BT)

- 1 Select [**Panel Color**] on the <User Customize> screen. (Page 44)

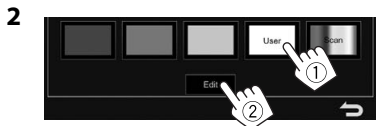

- 3 Select the dimmer setting for the color (①), then adjust the color (②).

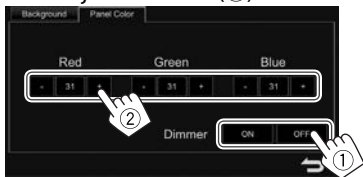

❑ Storing your own scene for the background image

While playing a video or picture, you can capture an image and use the captured image as a background.

- You cannot capture copyrighted content and images from iPod/iPhone.
- When using a JPEG file as the background, make sure that the resolution is 800 x 480 pixels.
- The color of the captured image may look different from that of the actual scene.

- 1 Play a video or picture.
- 2 Display the <User Customize> screen. (Page 44)

- 3 Display the image adjustment screen.



- 4 Adjust the image.

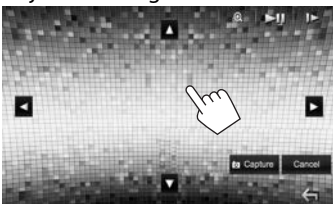

- [▲] [▼] [◀] [▶] Moves the zooming frame.
- [🔍] Magnifies the scene. (<OFF>, <Zoom1> - <Zoom3>)
- [▶|||]* Starts/pauses playback.
- [▶▶]* Advances scenes frame-by-frame.

- To cancel the capture, press [**Cancel**].

- 5 Capture the image displayed on the screen.



A confirmation message appears. Press [**Yes**] to store the newly captured image. (The existing image is replaced with the new one.)

- Press [**No**] to return to the previous screen.

- * Not displayed when playing an external component connected to the iPod/AV-IN input terminal.

Customizing the Home screen

You can arrange the items to display on the Home screen.

- 1 Display the <HOME Customize> screen. On the Home screen:
 - Press [▼] repeatedly to change the page on the <Display> menu screen.

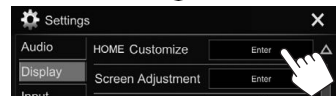
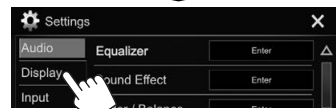
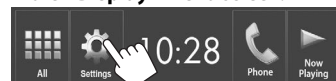

- You can also display the <HOME Customize> screen by pressing and holding one of the source button displayed on the Home screen.
- 2 Select the position to place the icon (①), then select the item you want to display in the selected position (②).

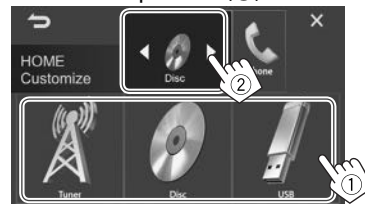

Repeat this step to place icons for other items.

SETTINGS

Customizing the system settings

❑ Memorizing/recalling the settings

- You can memorize the settings changed in the **<Settings>** menu and recall the memorized settings any time.
- The memorized settings are kept even when the unit is reset.

1 Display the **<SETUP Memory>** screen.

On the Home screen:

- Press [**▽**] repeatedly to change the page on the **<System>** menu screen.

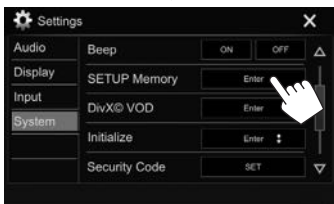
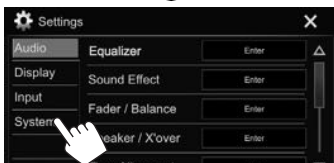

2



- To cancel, press [**No**].

3 Select an operation.

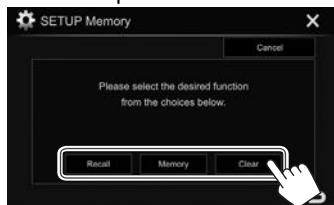

[Recall] Recalls the memorized settings.

[Memory] Memorizes the current settings.

[Clear] Clears the currently memorized settings.

- To cancel, press [**Cancel**].

A confirmation message appears. Press [**Yes**].

❑ Updating the system

You can update the system by connecting a USB device containing an update file.

- To update the system, visit <http://www.jvc.net/cs/car/>.

1 Create an update file and copy it to a USB device.

- To connect a USB device, see page 55.

2 Display the **<System Information>** screen.

On the Home screen:

- Press [**▽**] repeatedly to change the page on the **<System>** menu screen.

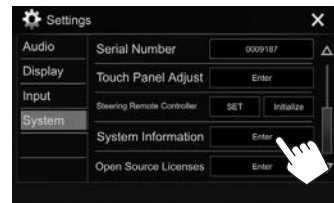
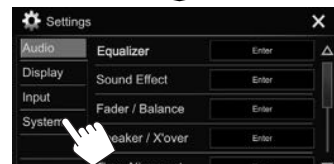
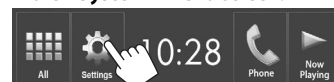

SETTINGS

3



- <Application Version>** Updates the system application.
- <System Version>** Updates the system.
- <DVD Version>** Updates the DVD system application.

It may take a while.

If the update has been completed successfully, "Update Completed" appears. Reset the unit.

- Do not disconnect the USB device while updating.
- If the update has failed, turn the power off and then on, and retry the update.
- Even if you have turned off the power during the update, you can restart the update after the power is turned on. The update will be performed from the beginning.

Adjusting the touch position

You can adjust the touch position on the touch panel if the position touched and the operation performed do not match.

1 Display the <Touch Panel Adjust> screen.

On the Home screen:

- Press [**▽**] repeatedly to change the page on the <System> menu screen.

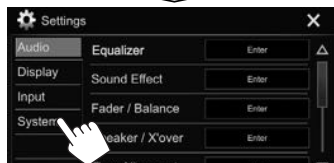
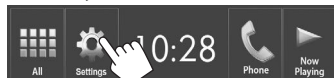

2 Touch the center of the marks at the upper left (1), the lower center (2), then the upper right (3) as instructed.

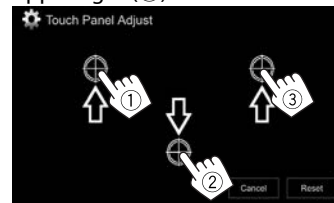

- To reset the touch position, press [**Reset**].
- To cancel the current operation, press [**Cancel**].

SETTINGS

Setting menu items

□ Displaying the <Settings> menu screen

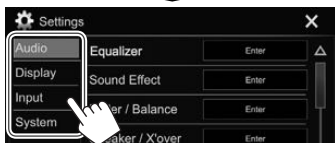
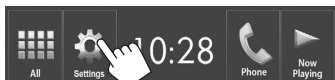

- You can change the page to display more items by pressing [▲]/[▼].
- You can also display the <Settings> screen by selecting [Settings] on the pop-up short-cut menu (Page 11).
- You cannot change the <Audio> settings screen in the following situations:
 - When the AV source is turned off. (Page 8)
 - When the Bluetooth phone is used (making or receiving a call, during a call, or while voice dialing)

□ <Audio> setting screen

<Equalizer>

Change the sound mode or adjust and store the equalization for each source. (Page 40)

- **Equalizer:** Selects the preset sound mode.
 - Flat (Initial)/Hard Rock/Pop/Hip Hop/R&B/Jazz/Classical/User
- **Q factor:** Adjusts the width of the frequency.
 - 1.35/1.5 (Initial)/2.0
- **Bass EXT:** Activates/deactivates bass.
 - ON/OFF (Initial)
- **SW LEVEL:** Adjusts the subwoofer level.
 - -50 to +10 (Initial: 0)

<Sound Effect>

Adjust the sound effect.

- **Loudness:** Adjusts loudness.
 - OFF (Initial)/Low/High
- **Bass Boost:** Selects the bass boost level.
 - OFF (Initial)/Level 1/Level 2/Level 3/Level 4/Level 5
- **Volume Link EQ:** You can reduce the driving noise by raising the bandwidth.
 - OFF (Initial)/ON
- **Space Enhancement*¹:** Virtually enhances the sound space using the Digital Signal Processor (DSP) system. Select the enhance level.
 - OFF (Initial)/Small/Medium/Large
- **K2*²:** Restores the sound lost due to audio compression to a realistic sound.
 - OFF/ON (Initial)

- **Sound Response:** Virtually makes the sound more realistic using the Digital Signal Processor (DSP) system. Select the sound level.
 - OFF (Initial)/Level 1/Level 2/Level 3
- **Sound Lift:** You can move the center of the sound to the lower or higher point. Select the height.
 - OFF (Initial)/Low/Middle/High

<Fader/Balance>

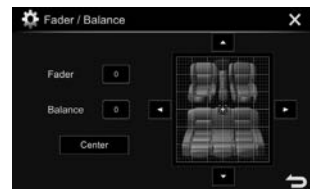

Fader: Adjusts the front and rear speaker output balance.

- **F15 to R15** (Initial: 0)
 - When using a two-speaker system, set the fader to the center (0).
- **Balance:** Adjusts the left and right speaker output balance.
- **L15 to R15** (Initial: 0)

Press [▲]/[▼]/[◀]/[▶] or drag [⊕] to adjust.

- To clear the adjustment, press [Center].

<Speaker/X'over>

Select the car type/speaker size and adjust the crossover frequency. (Page 41)

*¹ You cannot change the setting when "Tuner" is selected as the source.

*² This function works only when "DISC"/"USB"/"iPod"/"Android™" is selected as the source.

SETTINGS

<Time Alignment>

Select the listening position, then adjust the delay time of the speaker output to create a more suitable environment for your vehicle. (Page 42)

<Volume Offset>

Adjust and store the auto-adjustment volume level for each source. (For discs, the adjustment is stored for each of the following categories: DVD/VCD, CD, and DivX/MPEG1/MPEG2/WMV/MP3/WMA/WAV/AAC.) The volume level will automatically increase or decrease when you change the source.

- **-15 to +6** (Initial: **00**)

<Display> setting screen

<Dimmer>

- **Auto** (Initial): Dims the screen and button illumination when you turn on the headlights.
- **ON**: Activates dimmer.
- **OFF**: Cancels.

<User Customize>

Change the display design. (Page 44)

<OSD Clock>

- **ON**: Displays the clock while a video source is playing.
- **OFF** (Initial): Cancels.

<Demonstration>

- **ON** (Initial): Activates the demonstration on the screen.
- **OFF**: Cancels.

<Scroll>

- **ON** (Initial): Scrolls the displayed information repeatedly.
- **Once**: Scrolls the displayed information once.
- **OFF**: Cancels.

Pressing [**◀**] scrolls the text regardless of this setting.

<HOME Customize>

Change the items to display on the Home screen. (Page 45)

<Screen Adjustment>

Adjust the brightness and blackness of the screen. Press [**Enter**] to display the setting screen, select [**DIM ON**] (dimmer on)/[**DIM OFF**] (dimmer off), then change the following settings:

- **Bright**: Adjusts brightness.
 - **-15 to +15** (Initial: **0** for dimmer on/+**15** for dimmer off)
- **Black**: Adjusts blackness.
 - **-10 to +10** (Initial: **0**)

<Video Output>*¹

Select the color system of the external monitor.

- **NTSC/PAL** (Initial)

<Angle>*²

Adjust the panel angle. (Page 7)

*¹ "Please Power Off" appears when the setting is changed. Turn off the power, then turn on to enable the change.

*² Only for KW-V420BT.

<Input> setting screen

<Rear Camera>

Configure the rear view camera settings.

- **Rear Camera Interruption** (Page 28):
 - **ON**: Displays the picture from the rear view camera when you shift the gear to the reverse (R) position.
 - **OFF** (Initial): Select this when no camera is connected.
- **Parking Guidelines**: Displays (**ON**: Initial) or hides (**OFF**) the parking guidelines. (Page 29)
- **Guidelines Setup**: Adjusts the parking guidelines. (Page 29)

<Navigation Input>*

- **iPhone**: Switches to the screen of App from the connected iPod touch/iPhone by pressing DISP (for KW-V420BT)/ (for KW-V320BT/KW-V220BT) on the monitor panel. (Page 23)
- **OFF**: Switches to the current source control screen.

* To change the setting, turn off the AV source by pressing [**AV Off**] on the Home screen beforehand.

SETTINGS

☐ <System> setting screen

<Language>*

Select the text language used for on-screen information.

- **English** (Initial for KW-V420BT Region 2/ KW-V320BT Region 2/KW-V220BT Region 2)/ **Español/Français/Deutsch/Italiano/ Nederlands/Português/Türkçe/Русский** (Initial for KW-V420BT Region 5/KW-V320BT Region 5/ KW-V220BT Region 5)/**עברית/العربية/فارسی/ភាសាខ្មែរ/ไทย**
Indonesia
 - For external monitors, only English/Spanish/ French/German/Italian/Dutch/Russian/ Portuguese are available. If another language has been selected, the text language for external monitors will be set to English.
- **GUI Language:** Selects the language used for displaying operation buttons and menu items.
 - **English** (Initial)/**Local** (the language selected above)

<Clock>

Adjust the clock time. (Page 4)

<iPod Setup>

Specify the connection method of iPod/iPhone. (Page 21)

<APP Setup>

Configure the App settings. (Page 39)

<Bluetooth Setup>

Configure settings for using a Bluetooth device, such as connection and other general operations. (Page 38)

<Beep>

- **ON** (Initial): Activates the key-touch tone.
- **OFF:** Cancels.

<SETUP Memory>

You can memorize, recall, or clear the settings you have made. (Page 46)

<DivX(R) VOD>

This unit has its own Registration Code. Once you have played back a file with the Registration Code recorded, this unit's Registration Code is overwritten for copyright protection.

- Press **[Enter]** to display the information.
- To return to the previous screen, press **[OK]**.

<Initialize>

Initialize all settings you have made. Hold **[Enter]** to initialize the settings.

- After initializing the settings, adjust the settings on the **<Initial Settings>** screen.

<Touch Panel Adjust>

Adjust the touch positions of the buttons on the screen. (Page 47)

<System Information>

Displays the version information of the software. You can update the software. (Page 46)

<Open Source Licenses>

Shows the Open Source Licenses.

- * "Please Power Off" appears when the setting is changed. Turn off the power, then turn on to enable the change.

REMOTE CONTROLLER

(Only for KW-V420BT Region 2/KW-V320BT Region 2/KW-V220BT Region 2)

To use the remote controller, purchase RM-RK258 separately.

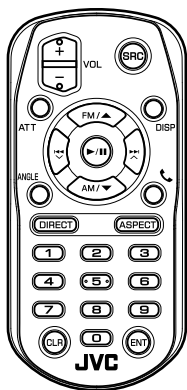

❑ Changing the battery of the remote controller

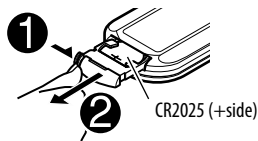

- Use a commercially available button battery (CR2025).
- Insert the battery with the + and – poles aligned properly.
 - If the effectiveness of the remote controller decreases, replace the battery.

⚠ Caution:

- Keep the battery out of reach of children and in original package until ready to use. Dispose of used batteries promptly. If swallowed contact physician immediately.
- Do not leave the battery near fire or under direct sunlight. A fire, explosion or excessive heat generation may result.
- Do not set the remote control in hot places such as on the dashboard.
- Danger of explosion if Lithium battery is incorrectly replaced. Replace only with the same or equivalent type.

Before using the remote controller:

- Aim the remote controller directly at the remote sensor on the unit.
- DO NOT expose the remote sensor to bright light (direct sunlight or artificial lighting).

Preparation

❑ Removing the battery sheet

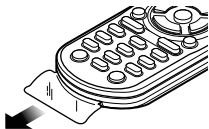

Pull the battery sheet out from the remote controller to activate the battery.



REMOTE CONTROLLER

Operations using the remote controller (RM-RK258)

Basic button functions

| | |
|--|--|
| ATT | Attenuates/restores the sound. |
| DISP | Switches the screen between the current source and the App screen from the connected iPod touch/iPhone/Android. |
| FM/▲ / AM/▼ | <ul style="list-style-type: none">• Selects the band.• Selects a title/item/folder. |
|  | <ul style="list-style-type: none">• Searches for stations automatically.• Searches for stations manually. (Hold)• Selects a track. |
| VOL +/ VOL - | Adjusts the volume level. |
| SRC | Selects the source. |
|  | Starts/pauses* ¹ playback. |
|  | Answers incoming calls. |
| 0 - 9 | Enters a number. (See the far right column.) |



| | |
|--------|--|
| 1 - 6 | Enters preset station number. |
| ANGLE | Tilts the monitor panel.* ² |
| ASPECT | Changes the aspect ratio. <ul style="list-style-type: none">• To check the current aspect ratio setting, operate on the touch panel. (Page 43) |
| ENT | Confirms selection. |
| DIRECT | Enters direct search mode. (See the right column.) |
| CLR | Erases the misentry. |

*¹ Does not work while listening to Bluetooth audio.

*² Available for KW-V420BT only.

Searching for an item directly

Tuner frequency

- 1 Press DIRECT to enter the search mode.
- 2 Press number buttons to enter a frequency.
 - To erase a misentry, press CLR (clear).
- 3 Press  /  to confirm the entry.

- To exit the search mode, press DIRECT, FM/▲, or AM/▼.

Chapter/title/folder/file/track on the disc

- 1 Press DIRECT to enter the search mode.
 - Each time you press DIRECT, the item to search for changes.
- 2 Press a number button to select a desired item.
 - To erase a misentry, press CLR (clear).
- 3 Press ENT to confirm the selection.

- To exit the search mode, press DIRECT, FM/▲, or AM/▼.

Disc operations

Using the VCD menu

During PBC playback...

- 1 Press DIRECT to enter the search mode.
- 2 Press a number button to select the item you want to play.
- 3 Press ENT to confirm the selection.

- To exit the search mode, press DIRECT, FM/▲, or AM/▼.

CONNECTION/INSTALLATION

Before installing the unit

⚠ WARNING

- If you connect the ignition wire (red) and the battery wire (yellow) to the car chassis (ground), you may cause a short circuit, that in turn may start a fire. Always connect those wires to the power source running through the fuse box.
- Do not cut out the fuse from the ignition wire (red) and the battery wire (yellow). The power supply must be connected to the wires via the fuse.

⚠ Precautions on installation and connection

- Mounting and wiring this product requires skills and experience. For best safety, leave the mounting and wiring work to professionals.
- Make sure to ground the unit to a negative 12 V DC power supply.
- Do not install the unit in a location exposed to direct sunlight or excessive heat or humidity. Also avoid places with too much dust or the possibility of water splashing.
- Do not use your own screws. Use only the screws provided. If you use the wrong screws, you could damage the unit.
- If the power is not turned on (“Miswiring DC Offset Error”, “Warning DC Offset Error” is displayed), the speaker wire may have a short circuit or have touched the chassis of the vehicle and the protection function may have been activated. Therefore, the speaker wire should be checked.
- Keep all cables away from heat dissipate metal parts.
- If your car’s ignition does not have an ACC position, connect the ignition wires to a power source that can be turned on and off with the ignition key. If you connect the ignition wire to a power source with a constant voltage supply, such as with battery wires, the battery may be drained.

- Only for KW-V420BT:
If the console has a lid, make sure to install the unit so that the monitor panel will not hit the lid when closing and opening.
- If the fuse blows, first make sure the wires are not touching to cause a short circuit, then replace the old fuse with one with the same rating.
- Insulate unconnected wires with vinyl tape or other similar material. To prevent a short circuit, do not remove the caps on the ends of the unconnected wires or the terminals.
- Connect the speaker wires correctly to the terminals to which they correspond. The unit may be damaged or fail to work if you share the ⊖ wires or ground them to any metal part in the car.
- When only two speakers are being connected to the system, connect both connectors either to the front output terminals or to the rear output terminals (do not mix front and rear). For example, if you connect the ⊕ connector of the left speaker to a front output terminal, do not connect the ⊖ connector to a rear output terminal.
- After the unit is installed, check whether the brake lamps, blinkers, wipers, etc. on the car are working properly.
- Mount the unit so that the mounting angle is 30° or less.
- Do not press hard on the panel surface when installing the unit to the vehicle. Otherwise scratches, damage, or failure may result.

⚠ CAUTION

Install this unit in the console of your vehicle. Do not touch the metal parts of this unit during and shortly after the use of the unit. Metal parts such as the heat sink and enclosure become hot.

❑ Supplied accessories for installation

- ① Wiring harness x 1
- ② Trim plate x 1
- ③ Extension wire (2 m) x 1
- ④ Extraction keys x 2
- ⑤ Microphone (3 m) x 1

❑ Installation procedure

- 1 To prevent a short circuit, remove the key from the ignition and disconnect the ⊖ battery.
- 2 Make the proper input and output wire connections for each unit.
- 3 Connect the speaker wires of the wiring harness.
- 4 Take Connector B on the wiring harness and connect it to the speaker connector in your vehicle.
- 5 Take Connector A on the wiring harness and connect it to the external power connector in your vehicle.
- 6 Connect the wiring harness connector to the unit.
- 7 Install the unit in your car.
 - Make sure that the unit is installed securely in place. If the unit is unstable, it may malfunction (eg, the sound may skip).
- 8 Reconnect the ⊖ battery.
- 9 Press the reset button. (Page 3)
- 10 Configure <Initial Settings>. (Page 4)

CONNECTION/INSTALLATION

Connection

Connecting wires to terminals

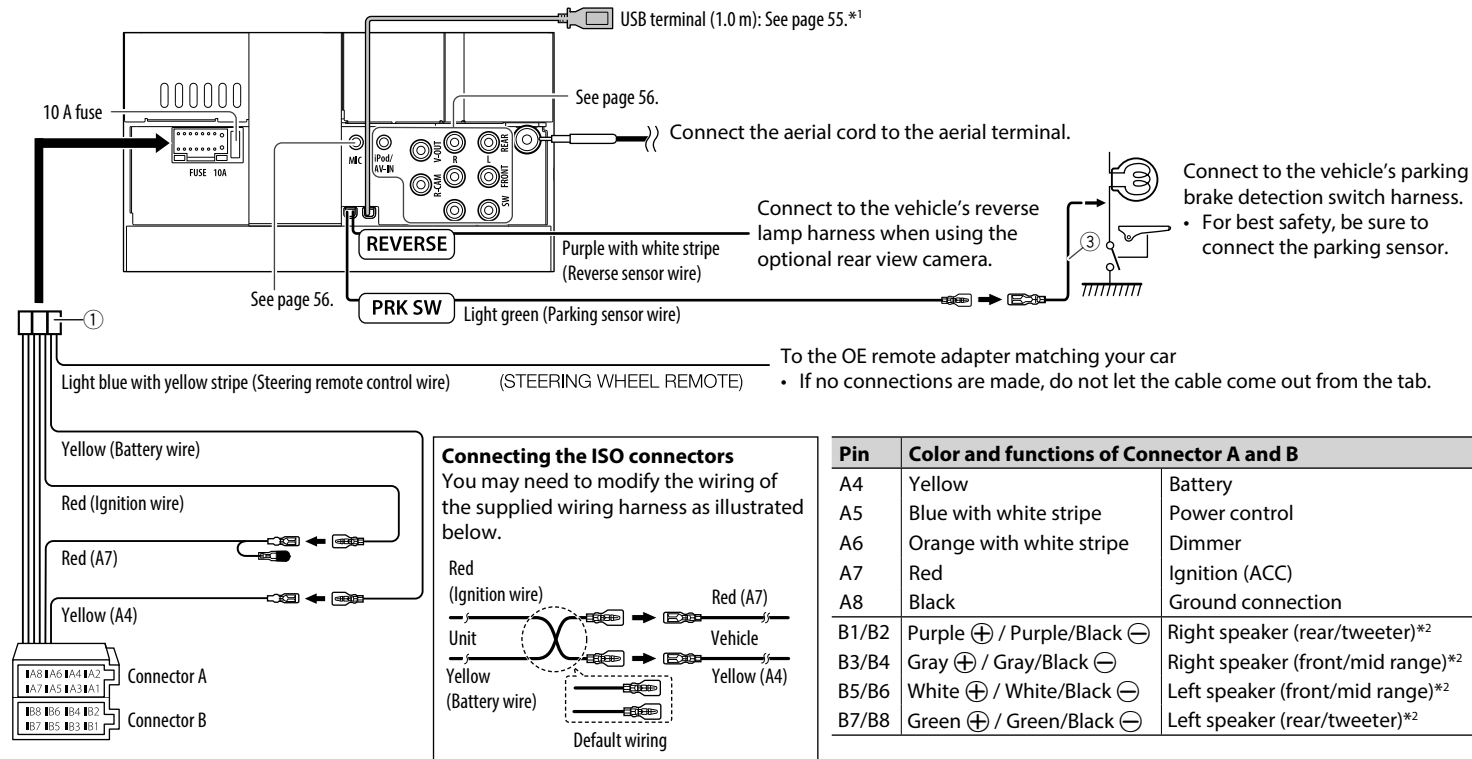

*¹ Only for KW-V420BT/KW-V320BT.

*² For 3 way speaker system connection, see also page 56.

CONNECTION/INSTALLATION

❑ Connecting a USB device

USB device
(commercially available)

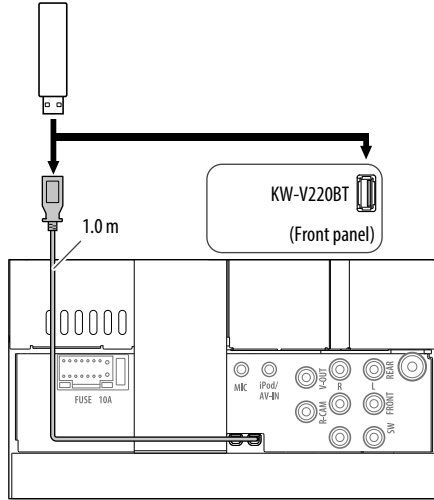

❑ Connecting an Android device

Android device
(commercially available)

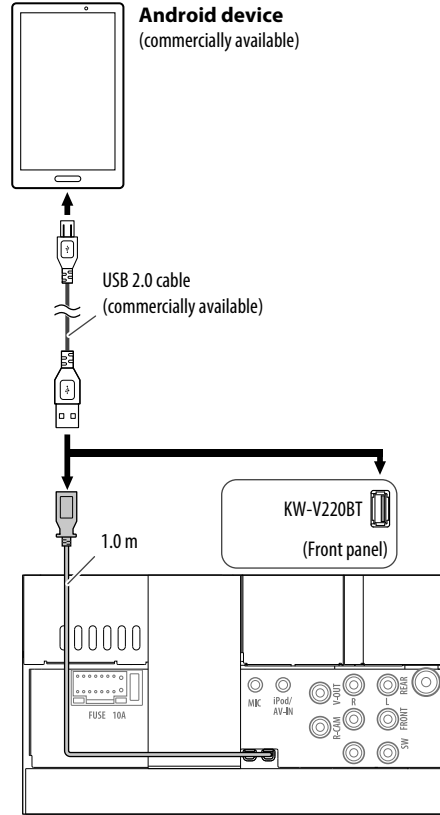

❑ Connecting iPod/iPhone

iPod/iPhone (Lightning connector models)
(commercially available)

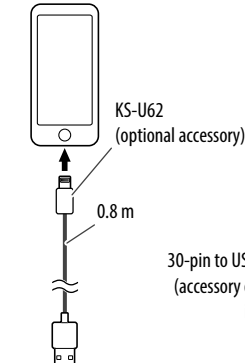

iPod/iPhone (30-pin connector models)
(commercially available)

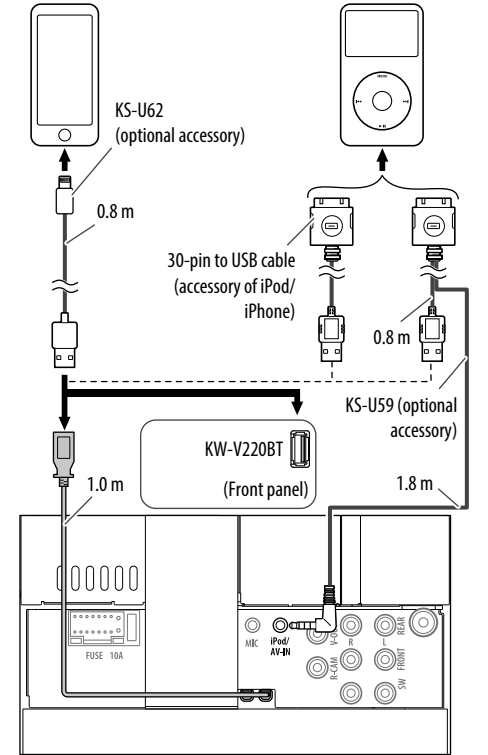

CONNECTION/INSTALLATION

Connecting external components

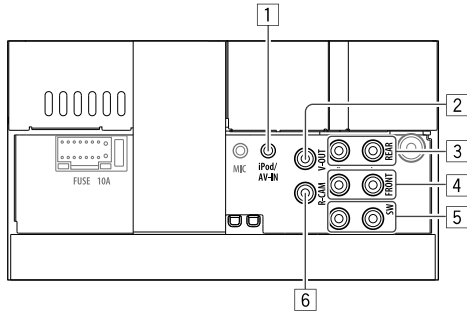

1 iPod/AV-IN input

- Connect the following type of 4-pole mini plug:

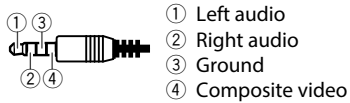

2 Video output (Yellow)

3 Rear preout*

- Audio left output (White)
- Audio right output (Red)

4 Front preout*

- Audio left output (White)
- Audio right output (Red)

5 Subwoofer preout*

- Subwoofer left output (White)
- Subwoofer right output (Red)

6 Rear view camera input (Yellow)

- * When connecting an external amplifier, connect its ground wire to the chassis of the car; otherwise the unit may be damaged.

Connecting external amplifiers for 3 way speakers system

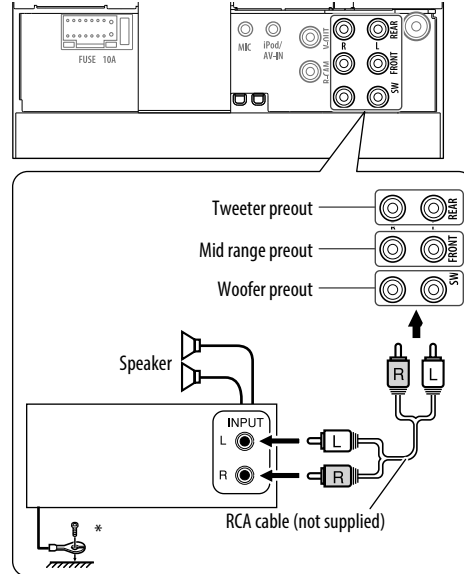

- * When connecting to an external amplifier, connect its ground wire to the car's chassis.

Connecting microphone for Bluetooth

Connect the microphone (5) to the MIC terminal.

- To install the microphone, peel off the adhesive tape, fix on the installation position, then adjust the direction of the microphone to face the driver. After installing, fix the microphone cable to the car with clamps (commercially available).

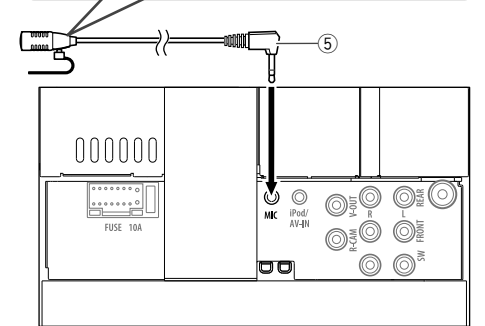
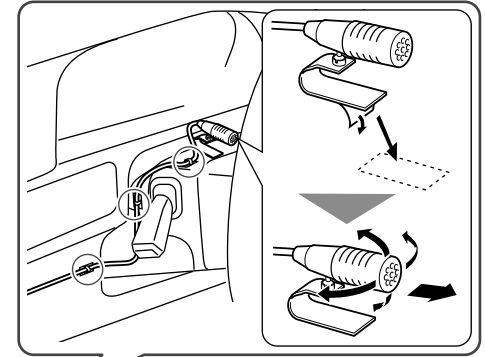

CONNECTION/INSTALLATION

Installing/removing the unit

❑ Installing the unit

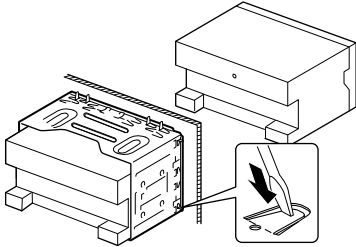

- Bend the tabs of the mounting sleeve with a screwdriver or similar utensil and attach it in place.

❑ Installing the trim plate

Attach the trim plate (2).

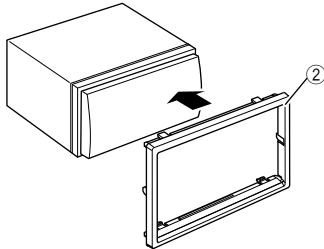

❑ Removing the trim plate

- 1 Engage the catch pins on the extraction key (4) and remove the two locks on the lower part. Lower the frame and pull it forward.

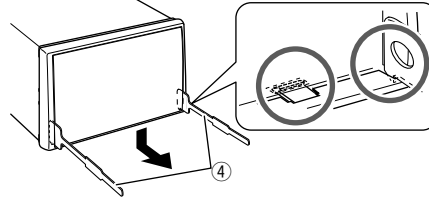

- 2 Remove from the upper two catches.

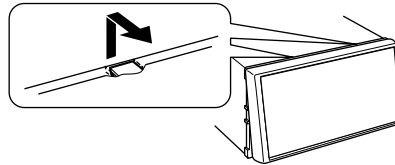

- The frame can be removed from the top side in the same manner.

❑ Removing the unit

- 1 Remove the trim plate. (See the left column.)
- 2 Insert the two extraction keys (4), then pull them as illustrated so that the unit can be removed.

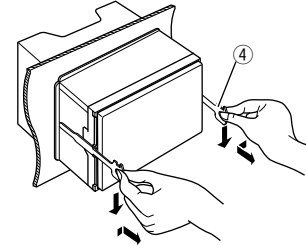

- Be careful to avoid injury from the catch pins on the extraction key.

REFERENCES

Maintenance

❑ Caution on cleaning the unit

Do not use any solvent (for example, thinner, benzine, etc.), detergent, or insecticide. This may damage the monitor or the unit.

Recommended cleaning method:

Gently wipe the panel with a soft, dry cloth.

❑ Moisture condensation

Moisture may condense on the lens inside the unit in the following cases:

- After starting the heater in the car.
- If it becomes very humid inside the car.

Should this occur, the unit may malfunction. In this case, eject the disc and leave the unit turned on for a few hours until the moisture evaporates.

❑ How to handle discs

- When removing a disc from its case, press down the center holder of the case and lift the disc out, holding it by the edges.



- Always hold the disc by the edges. Do not touch its recording surface.
- When storing a disc in its case, gently insert the disc around the center holder (with the printed surface facing up).
 - Make sure to store discs in their cases after use.

❑ To keep discs clean

Dirty discs may not play correctly.

If a disc does become dirty, wipe it with a soft cloth in a straight line from the center to the edge.



- Do not use any solvents (for example, conventional record cleaner, spray, thinner, benzine, etc.) to clean discs.

❑ To play new discs

New discs may have some rough spots around the inner and outer edges. If such a disc is used, this unit may reject the disc.



- To remove these rough spots, rub the edges with a pencil or ball-point pen, etc.

More information

❑ File playback

Playing DivX files

- This unit can play back DivX files with the extension code <.divx>, <.div>, or <.avi> (regardless of the letter case—upper/lower).
- Audio streams should conform to MP3 or Dolby Digital.
- Files encoded in the interlaced scanning mode may not be played back correctly.
- The maximum bit rate for video signals (average) is 8 Mbps.

Playing MPEG1/MPEG2 files

- This unit can play back MPEG1/MPEG2 files with the extension code <.mpg>, <.mpeg>.
- The stream format should conform to MPEG system/program stream.
The file format should be MP@ML (Main Profile at Main Level)/SP@ML (Simple Profile at Main Level)/MP@LL (Main Profile at Low Level).
- Audio streams should conform to MPEG1 Audio Layer-2 or Dolby Digital.

REFERENCES

Playing JPEG files

- This unit can play back picture files with the extension code <.jpg> or <.jpeg>.
- This unit can play back files that are at 32 x 32 to 8 192 x 7 680 resolution. It may take time to display the file depending on its resolution.
- This unit can play back baseline JPEG files. Progressive JPEG files or lossless JPEG files cannot be played.

Playing audio files (MP3/WMA/WAV/AAC)

- This unit can play back files with the extension code <.mp3>, <.wma>, <.wav> or <.m4a> (regardless of the letter case—upper/lower).
- This unit can play back files that meet the conditions below:
 - Bit rate:
 - MP3: 8 kbps – 320 kbps
 - WMA: 5 kbps – 320 kbps
 - AAC: 16 kbps – 320 kbps
 - Sampling frequency:
 - 8 kHz – 48 kHz (for MP3/WMA)
 - 44.1 kHz (for WAV)
 - 32 kHz – 48 kHz (for AAC)
- This unit can show ID3 Tag Version 1.0/1.1/2.2/3/2.4 (for MP3).
- This unit can also show WMA/WAV/AAC Tag.
- This unit can play back files recorded in VBR (variable bit rate).
- Files recorded in VBR have a discrepancy in elapsed time indication.

- This unit cannot play back the following files:
 - MP3 files encoded with MP3i and MP3 PRO format.
 - MP3 files encoded with Layer 1/2.
 - WMA files encoded with lossless, professional, and voice format.
 - WMA files which are not based upon Windows Media® Audio.
 - WMA/AAC files copy-protected with DRM.
 - AAC files encoded using any other application than iTunes.
 - AAC files copy-protected with FairPlay (except those stored on an iPod/iPhone).
 - Files which have data such as AIFF, ATRAC3, etc.
- This unit can display jacket pictures that meet the conditions below:
 - Picture size: 32 x 32 to 1 232 x 672 resolution
 - Data size: less than 500 KB
 - File type: JPEG

Disc playback

Playable disc types

| Disc type | Recording format, file type, etc. |
|---|---|
| DVD | DVD Video*1 |
| <ul style="list-style-type: none"> • DTS sound cannot be reproduced or emitted from this unit. | |
| DVD Recordable/Rewritable (DVD-R/-RW*2, +R/+RW*3) | <ul style="list-style-type: none"> • DVD Video • DivX/MPEG1/MPEG2/JPEG • MP3/WMA/WAV/AAC |
| <ul style="list-style-type: none"> • DVD Video: UDF bridge • DivX/MPEG1/MPEG2/MP3/WMA/WAV/AAC: ISO 9660 level 1, level 2, Romeo, Joliet | |
| Dual Disc | DVD side |
| CD/VCD | <ul style="list-style-type: none"> • VCD (Video CD) • Audio CD/CD Text (CD-DA) |
| CD Recordable/Rewritable (CD-R/-RW) | <ul style="list-style-type: none"> • VCD (Video CD) • CD-DA • DivX/MPEG1/MPEG2/JPEG • MP3/WMA/WAV/AAC |
| <ul style="list-style-type: none"> • ISO 9660 level 1, level 2, Romeo, Joliet | |

*1 DVD Region code: 2/5 (depending on the country and sales area) If you insert a DVD Video disc of an incorrect Region Code, "Region Code Error" appears on the screen.

*2 DVD-R recorded in multi-border format are also playable (except for dual layer discs). DVD-RW dual layer discs are not playable.

*3 It is possible to play back finalized +R/+RW (Video format only) discs. "DVD" is selected as the disc type when a +R/+RW disc is loaded. +RW double layer discs are not playable.

REFERENCES

Unplayable discs

- Unplayable disc types and formats are as follows:
 - DVD-Audio/DVD-ROM discs
 - MPEG4/FLAC/MKV/DVD–VR/DVD+VR/DVD-RAM recorded on DVD-R/RW or +R/+RW
 - SVCD (Super Video CD), CD-ROM, CD-I (CD-I Ready), DTS-CD
 - MPEG4/FLAC/MKV recorded on CD-R/RW
- Discs that are not round.
- Discs with coloring on the recording surface or discs that are dirty.
- Recordable/Rewritable discs that have not been finalized.
- 8 cm discs. Attempting to insert these discs using an adapter may cause a malfunction.

DualDisc playback

The Non-DVD side of a “DualDisc” does not comply with the “Compact Disc Digital Audio” standard. Therefore, the use of the Non-DVD side of a DualDisc on this product cannot be recommended.

Playing Recordable/Rewritable discs

- This unit can recognize a total of 5 000 files and 250 folders (a maximum of 999 files per folder).
- Use only “finalized” discs.
- This unit can play back multi-session discs; however, unclosed sessions will be skipped while playing.
- Some discs or files may not be played back due to their characteristics or recording conditions.

❑ About data stored in the connected USB device/iPod/iPhone/Android

- We bear no responsibility for any loss of data in iPod/iPhone, Android, and USB mass storage class devices while using this unit.

❑ USB playback

Playable files on a USB device

- This unit can play the following types of files stored in a USB mass storage class device.
 - JPEG/DivX/MPEG1/MPEG2/MP3/WMA/WAV/AAC
- This unit can recognize a total of 5 000 files and 250 folders (a maximum of 999 files per folder).
- Make sure all important data has been backed up to avoid losing the data.

Notes on using a USB device:

- This unit may not play back files in a USB device properly when using a USB extension cable.
- USB devices equipped with special functions such as data security functions cannot be used with the unit.
- Do not use a USB device with 2 or more partitions.
- Depending on the shape of the USB devices and connection ports, some USB devices may not be attached properly or the connection might be loose.
- This unit may not recognize a memory card inserted into a USB card reader.
- When connecting with a USB cable, use a USB 2.0 cable.

- The maximum number of characters (when the characters are 1 byte):
 - Folder names: 50 characters
 - File names: 50 characters
- Avoid using the USB device if it might affect driving safety.
- Do not pull out and connect the USB device repeatedly while “Reading” is shown on the screen.
- Electrostatic shock at connecting a USB device may cause abnormal playback of the device. In this case, disconnect the USB device then reset this unit and the USB device.
- Operation and power supply may not work as intended for some USB devices.
- Do not leave a USB device in the car, or expose to direct sunlight or high temperatures to prevent deformation or damage to the device.

❑ Notes on playing iPod/iPhone

- iPod/iPhone that can be connected to this unit:
 - Made for
 - iPod with video
 - iPod classic
 - iPod nano (7th Generation)*
 - iPod nano (6th Generation)
 - iPod nano (5th Generation)
 - iPod nano (4th Generation)
 - iPod nano (3rd Generation)
 - iPod touch (5th Generation)*
 - iPod touch (4th Generation)
 - iPod touch (3rd Generation)
 - iPhone 6 Plus*
 - iPhone 6*
 - iPhone 5S*

REFERENCES

- iPhone 5C*
- iPhone 5*
- iPhone 4S
- iPhone 4
- iPhone 3GS
- iPhone 3G
- iPhone

* You cannot watch video when connecting Lightning connector models.

- When operating an iPod/iPhone, some operations may not be performed correctly or as intended. In this case, visit the following JVC web site: <<http://www.jvc.net/cs/car/>>
- For some iPod/iPhone models, the performance may be abnormal or unstable during operation. In this case, disconnect the iPod/iPhone device, then check its condition.
If the performance is not improved or slow, reset your iPod/iPhone.
- When you turn on this unit, the iPod/iPhone is charged through the unit.
- The text information may not be displayed correctly.

Language codes (for DVD language selection)

| | | | | | | | |
|----|-----------------|----|------------------|----|----------------|----|------------|
| AA | Afar | GL | Galician | MI | Maori | SO | Somali |
| AB | Abkhazian | GN | Guarani | MK | Macedonian | SQ | Albanian |
| AF | Afrikaans | GU | Gujarati | ML | Malayalam | SR | Serbian |
| AM | Ameharic | HA | Hausa | MN | Mongolian | SS | Siswati |
| AR | Arabic | HI | Hindi | MO | Moldavian | ST | Sesotho |
| AS | Assamese | HR | Croatian | MR | Marathi | SU | Sundanese |
| AY | Aymara | HU | Hungarian | MS | Malay (MAY) | SW | Swahili |
| AZ | Azerbaijani | HY | Armenian | MT | Maltese | TA | Tamil |
| BA | Bashkir | IA | Interlingua | MY | Burmese | TE | Telugu |
| BE | Byelorussian | IE | Interlingue | NA | Nauru | TG | Tajik |
| BG | Bulgarian | IK | Inupiak | NE | Nepali | TH | Thai |
| BH | Bihari | IN | Indonesian | NO | Norwegian | TI | Tigrinya |
| BI | Bislama | IS | Icelandic | OC | Occitan | TK | Turkmen |
| BN | Bengali, Bangla | IW | Hebrew | OM | (Afan) Oromo | TL | Tagalog |
| BO | Tibetan | JA | Japanese | OR | Oriya | TN | Setswana |
| BR | Breton | JI | Yiddish | PA | Panjabi | TO | Tonga |
| CA | Catalan | JW | Javanese | PL | Polish | TR | Turkish |
| CO | Corsican | KA | Georgian | PS | Pashto, Pushto | TS | Tsonga |
| CS | Czech | KK | Kazakh | QU | Quechua | TT | Tatar |
| CY | Welsh | KL | Greenlandic | RM | Rhaeto-Romance | TW | Twi |
| DZ | Bhutani | KM | Cambodian | RN | Kirundi | UK | Ukrainian |
| EL | Greek | KN | Kannada | RO | Rumanian | UR | Urdu |
| EO | Esperanto | KO | Korean (KOR) | RW | Kinyarwanda | UZ | Uzbek |
| ET | Estonian | KS | Kashmiri | SA | Sanskrit | VI | Vietnamese |
| EU | Basque | KU | Kurdish | SD | Sindhi | VO | Volapuk |
| FA | Persian | KY | Kirghiz | SG | Sangho | WO | Wolof |
| FI | Finnish | LA | Latin | SH | Serbo-Croatian | XH | Xhosa |
| FJ | Fiji | LN | Lingala | SI | Singhalese | YO | Yoruba |
| FO | Faroese | LO | Laothian | SK | Slovak | ZU | Zulu |
| FY | Frisian | LT | Lithuanian | SL | Slovenian | | |
| GA | Irish | LV | Latvian, Lettish | SM | Samoan | | |
| GD | Scots Gaelic | MG | Malagasy | SN | Shona | | |

REFERENCES

Error message list

If an error occurs while using the unit, a message appears. Take appropriate action according to the following message/remedy/cause list.

“No Signal”/“No Video Signal”:

- Start playback on the external component connected to the iPod/AV-IN input terminal.
- Check the cords and connections.
- Signal input is too weak.

“Miswiring DC Offset Error”/“Warning DC Offset Error”:

- A speaker cord has shorted or it has come into contact with the car chassis. Wire or insulate the speaker cord as appropriate, then reset the unit. (Pages 3 and 54)

“Parking off”:

- No playback picture is shown when the parking brake is not engaged.

“Authorization Error”:

- Check whether the connected iPod/iPhone is compatible with this unit. (Page 60)

“USB Device Error”:

- The USB power voltage is abnormal.
- Turn off and turn on the unit.
- Connect another USB device.

“Panel Mecha Error”:

- The panel does not work properly. Reset the unit.

“No Navigation”:

- No navigation unit is connected.

“Connection Error”:

- The device is registered but the connection has failed. Connect the registered device. (Page 33)

“Please Wait...”:

- The unit is preparing to use the Bluetooth function. If the message does not disappear, turn off and turn on the unit, then connect the device again (or reset the unit).

“No Voice Device”:

- The connected mobile phone does not have a voice recognition system.

“No Data”:

- No phone book data is contained in the connected Bluetooth phone.

“Initialize Error”:

- The unit has failed to initialize the Bluetooth module. Try the operation again.

“Dial Error”:

- Dialing has failed. Try the operation again.

“Hung Up Error”:

- The call has not ended yet. Park your car, and use the connected mobile phone to end the call.

“Pick Up Error”:

- The unit has failed to receive a call.

Troubleshooting

What appears to be trouble is not always serious. Check the following points before calling a service center.

- For operations with the external components, refer also to the instructions supplied with the adapters used for the connections (as well as the instructions supplied with the external components).

□ General

No sound comes out of the speakers.

- Adjust the volume to the optimum level.
- Check the cords and connections.

No picture is displayed on the screen.

- Turn on the screen. (Page 8)

The unit does not work at all.

- Reset the unit. (Page 3)

The remote controller* does not work.

- Replace the battery.

* Only for KW-V420BT Region 2/KW-V320BT Region 2/KW-V220BT Region 2: purchase RM-RK258 separately.

REFERENCES

❑ Discs

Recordable/Rewritable discs cannot be played back.

- Insert a finalized disc.
- Finalize the discs with the component which you used for recording.

Tracks on the Recordable/Rewritable discs cannot be skipped.

- Insert a finalized disc.
- Finalize the discs with the component which you used for recording.

Playback does not start.

- The format of files is not supported by the unit.

No picture appears on the external monitor.

- Connect the video cord correctly.
- Select the correct input on the external monitor.

DivX/MPEG1/MPEG2/MP3/WMA/WAV/AAC discs cannot be played back.

- Record the tracks using a compatible application on the appropriate discs. (Page 59)
- Add appropriate extension codes to the file names.

Tracks on the Recordable/Rewritable discs are not played back as you have intended them to play.

- Playback order may differ from the one played back using other players.

❑ USB

“Reading” does not disappear from the screen.

- Turn the power off and on again.

While playing a track, sound is sometimes interrupted.

- The tracks are not properly copied into the USB device. Copy the tracks again, and try again.

Tracks are not played back as you have intended them to play.

- Playback order may differ from the one played back using other players.

❑ Android

Sound cannot be heard during playback.

- Reconnect the Android device.
- When <Android Setup> is set to [AUDIO MODE], launch any media player application on the Android device and start playback.

Sound output only from the Android device.

- When <Android Setup> is set to [AUDIO MODE], relaunch the current media player application or use another media player application.
- Restart the Android device.
- If this does not solve the problem, the connected Android device is unable to route the audio signal to unit.

Cannot playback when <Android Setup> is set to [AUTO MODE].

- Make sure JVC Music Play APP is installed on the Android device.
- Reconnect the Android device and select the appropriate control mode.
- If this does not solve the problem, the connected Android device does not support the Auto Mode.

“NO DEVICE” or “READING” keeps flashing.

- Switch off the developer options on the Android device.
- Reconnect the Android device.
- If this does not solve the problem, the connected Android device does not support the Auto Mode.

REFERENCES

❑ iPod/iPhone

No sound comes out of the speakers.

- Disconnect the iPod/iPhone, then connect it again.
- Select another source, then reselect “iPod”.

The iPod/iPhone does not turn on or does not work.

- Check the connecting cable and its connection.
- Update the firmware version.
- Charge the battery.
- Reset the iPod/iPhone.

Sound is distorted.

- Deactivate the equalizer either on this unit or the iPod/iPhone.

A lot of noise is generated.

- Turn off (uncheck) “VoiceOver” on the iPod/iPhone. For details, visit <<http://www.apple.com>>.

No operations are available when playing back a track containing artwork.

- Operate the unit after the artwork has loaded.

Videos cannot be played.

- Connect with USB Audio and Video cable KS-U59 (optional accessory) to iPod/iPhone 30-pin connector model. Other cables cannot be used.
- Select [USB+AV-IN] for <iPod Setup>. (Page 21)

No sound of videos comes out.

- Connect with USB Audio and Video cable KS-U59 (optional accessory) to iPod/iPhone 30-pin connector model. Other cables cannot be used.
- Select [USB+AV-IN] for <iPod Setup>. (Page 21)

❑ Tuner

SSM automatic presetting does not work.

- Store stations manually. (Page 25)

Static noise while listening to the radio.

- Connect the aerial firmly.

❑ AV-IN

“AV-IN” cannot be selected on the Home screen.

- Select [USB 1 Wire] for <iPod Setup>. (Page 21)

No picture appears on the screen.

- Turn on the video component if it is not on.
- Connect the video component correctly.

❑ Bluetooth

Phone sound quality is poor.

- Reduce the distance between the unit and the Bluetooth mobile phone.
- Move the car to a place where you can get a better signal reception.

The sound is interrupted or skipped while using a Bluetooth audio player.

- Reduce the distance between the unit and the Bluetooth audio player.
- Disconnect the device connected for Bluetooth phone.
- Turn off, then turn on the unit. (When the sound is not yet restored) connect the player again.

The connected audio player cannot be controlled.

- Check whether the connected audio player supports AVRCP (Audio/Video Remote Control Profile).

The Bluetooth device does not detect the unit.

- Search from the Bluetooth device again.

The unit does not pair with the Bluetooth device.

- For devices compatible with Bluetooth 2.1: Register the device using a PIN code. (Page 32)
- For devices compatible with Bluetooth 2.0: Enter the same PIN code for both the unit and target device. If the PIN code of the device is not indicated in its instructions, try “0000” or “1234.”
- Turn off, then turn on the Bluetooth device.

Echo or noise occurs.

- Adjust the microphone unit position.
- Adjust the echo volume or noise reduction volume. (Page 34)

The unit does not respond when you try to copy the phone book to the unit.

- You may have tried to copy the same entries (as stored) to the unit.

REFERENCES

Specifications

□ Monitor section

Picture Size (W x H)

KW-V420BT: 6.95 inches (diagonal) wide
156.6 mm × 81.6 mm

KW-V320BT/KW-V220BT:
6.2 inches (diagonal) wide
137.5 mm × 77.2 mm

Display System Transparent TN LCD panel

Drive System TFT active matrix system

Number of Pixels 1 152 000 (800H × 480V × RGB)

Effective Pixels 99.99%

Pixel Arrangement

RGB striped arrangement

Back Lighting LED

□ DVD player section

D/A Converter 24 bit

Audio Decoder Linear PCM/Dolby Digital/MP3/
WMA/WAV/AAC

Video Decoder DivX/MPEG1/MPEG2/JPEG

Wow & Flutter Below Measurable Limit

Frequency Response

96 kHz Sampling: 20 Hz to 22 000 Hz

48 kHz Sampling: 20 Hz to 22 000 Hz

44.1 kHz Sampling: 20 Hz to 20 000 Hz

Total Harmonic Distortion

0.010% (1 kHz)

Signal to Noise Ratio

99 dB (DVD-Video 96 kHz)

Dynamic Range 99 dB (DVD-Video 96 kHz)

Disc Format DVD-Video/VIDEO-CD/CD-DA

Sampling Frequency

44.1 kHz/48 kHz/96 kHz

Quantifying Bit Number

16/20/24 bit

□ USB interface section

USB Standard USB 2.0 Full Speed/High Speed

Compatible Device

Mass Storage Class

File System FAT 16/32

Maximum Power Supply Current

DC 5 V $\bar{=}$ 1.5 A

D/A Converter 24 bit

Audio Decoder MP3/WMA/AAC/WAV

Video Decoder DivX/MPEG1/MPEG2/JPEG

REFERENCES

Bluetooth section

| | |
|-----------------------------|--|
| Technology | Bluetooth 3.0 |
| Frequency | 2.402 GHz to 2.480 GHz |
| Output Power | +4 dBm (MAX), 0 dBm (AVE), Power Class 2 |
| Maximum Communication Range | Line of sight approx. 10 m |
| Audio Codec | SBC/AAC |
| Profile | HFP (Hands Free Profile) 1.6 A2DP (Advanced Audio Distribution Profile) 1.3 AVRCP (Audio/Video Remote Control Profile) 1.5 GAP (Generic Access Profile) PBAP (Phonebook Access Profile) 1.2 SDP (Service Discovery Profile) SPP (Serial Port Profile) 1.2 |

DSP section

| | |
|---------------------------|--|
| Equalizer | |
| Band (13 Band): | |
| Frequency (Hz) (BAND1-13) | 62.5/100/160/250/400/630/1k/ 1.6k/2.5k/4k/6.3k/10k/16k |
| Level | -09 to +09 (-9 dB to +9 dB) |
| Q | 1.35/1.5/2.0 |
| HPF (High Pass Filter): | |
| Frequency (Hz) | Through/30/40/50/60/70/80/90/ 100/120/150/180/220/250 |
| Slope | -6/-12/-18/-24 dB/Oct. |
| Gain | -8/-7/-6/-5/-4/-3/-2/-1/0 dB |
| LPF (Low Pass Filter): | |
| Frequency (Hz) | 30/40/50/60/70/80/90/ 100/120/150/180/220/250/ Through |
| Slope | -6/-12/-18/-24 dB/Oct. |
| Gain | -8/-7/-6/-5/-4/-3/-2/-1/0 dB |

FM tuner section

| | |
|------------------------------------|--------------------------------------|
| Frequency Range | |
| 50 kHz: | 87.5 MHz to 108.0 MHz |
| 30 kHz*: | 65.0 MHz to 74.0 MHz |
| Usable Sensitivity | |
| 50 kHz (S/N: 30 dB, 22.5 kHz): | 6.2 dBf (0.56 μ V/75 Ω) |
| 30 kHz* (S/N: 26 dB): | 8.2 dBf (0.71 μ V/75 Ω) |
| Quieting Sensitivity | |
| 50 kHz (S/N: 46 dB, 22.5 kHz): | 15.2 dBf (1.58 μ V/75 Ω) |
| 30 kHz* (S/N: 46 dB): | 17.2 dBf (2.0 μ V/75 Ω) |
| Frequency Response (\pm 3.0 dB) | |
| | 30 Hz to 15 kHz |
| Signal to Noise Ratio | |
| 50 kHz: | 68 dB (MONO) |
| 30 kHz*: | 64.0 dB (MONO) |
| Selectivity (\pm 400 kHz) | |
| | \geq 80 dB |
| Stereo Separation | 40 dB (1 kHz) |

* Only for KW-V420BT Region 5/KW-V320BT Region 5/KW-V220BT Region 5.

REFERENCES

□ LW tuner section

Frequency Range (9 kHz)
153 kHz to 279 kHz

Usable Sensitivity 45 μ V

□ MW tuner section

Frequency Range (9 kHz)
531 kHz to 1 611 kHz

Usable Sensitivity 28.5 μ V

□ Video section

Color System of External Video Input
NTSC/PAL

External Video Input Level (RCA/mini jack)
1 V_{p-p}/75 Ω

Video Output Level (RCA jack)
1 V_{p-p}/75 Ω

□ Audio section

Maximum Power (Front & Rear)
50 W \times 4

Full Bandwidth Power (Front & Rear)
22 W \times 4 (at less than 1%THD)

Preout Level 4 V/10 k Ω

Preout Impedance \leq 600 Ω

Speaker Impedance
4 Ω to 8 Ω

□ General

Operating Voltage
14.4 V (10.5 V to 16 V allowable)

Maximum Current Consumption
10 A

Installation Dimensions (W \times H \times D)
KW-V420BT: 182 mm \times 111 mm \times 165 mm
KW-V320BT/KW-V220BT:
182 mm \times 111 mm \times 160 mm

Operational Temperature Range
-10°C to +60°C

Weight
KW-V420BT: 2.6 kg
KW-V320BT/KW-V220BT: 1.9 kg

Design and specifications are subject to change without notice.

REFERENCES

☐ Trademarks and licenses

- Manufactured under license from Dolby Laboratories. Dolby and the double-D symbol are trademarks of Dolby Laboratories.
- “DVD Logo” is a trademark of DVD Format/Logo Licensing Corporation registered in the US, Japan and other countries.
- The “AAC” logo is a trademark of Dolby Laboratories.
- Microsoft and Windows Media are either registered trademarks or trademarks of Microsoft Corporation in the United States and/or other countries.
- “Made for iPod,” and “Made for iPhone” mean that an electronic accessory has been designed to connect specifically to iPod, or iPhone, respectively, and has been certified by the developer to meet Apple performance standards. Apple is not responsible for the operation of this device or its compliance with safety and regulatory standards. Please note that the use of this accessory with iPod, or iPhone may affect wireless performance. iPhone, iPod, iPod classic, iPod nano, and iPod touch are trademarks of Apple Inc., registered in the U.S. and other countries.
- Lightning is a trademark of Apple Inc.
- This item incorporates copy protection technology that is protected by U.S. patents and other intellectual property rights of Rovi Corporation. Reverse engineering and disassembly are prohibited.

- Font for this product is designed by Ricoh.
- THIS PRODUCT IS LICENSED UNDER THE MPEG-4 VISUAL PATENT PORTFOLIO LICENSE FOR THE PERSONAL AND NON-COMMERCIAL USE OF A CONSUMER FOR (i) ENCODING VIDEO IN COMPLIANCE WITH THE MPEG-4 VISUAL STANDARD (“MPEG-4 VIDEO”) AND/OR (ii) DECODING MPEG-4 VIDEO THAT WAS ENCODED BY A CONSUMER ENGAGED IN A PERSONAL AND NON-COMMERCIAL ACTIVITY AND/OR WAS OBTAINED FROM A VIDEO PROVIDER LICENSED BY MPEG LA TO PROVIDE MPEG-4 VIDEO. NO LICENSE IS GRANTED OR SHALL BE IMPLIED FOR ANY OTHER USE. ADDITIONAL INFORMATION INCLUDING THAT RELATING TO PROMOTIONAL, INTERNAL AND COMMERCIAL USES AND LICENSING MAY BE OBTAINED FROM MPEG LA, LLC. SEE [HTTP://WWW.MPEGLA.COM](http://www.mpegla.com).
- THIS PRODUCT IS LICENSED UNDER THE AVC PATENT PORTFOLIO LICENSE FOR THE PERSONAL USE OF A CONSUMER OR OTHER USES IN WHICH IT DOES NOT RECEIVE REMUNERATION TO (i) ENCODE VIDEO IN COMPLIANCE WITH THE AVC STANDARD (“AVC VIDEO”) AND/OR (ii) DECODE AVC VIDEO THAT WAS ENCODED BY A CONSUMER ENGAGED IN A PERSONAL ACTIVITY AND/OR WAS OBTAINED FROM A VIDEO PROVIDER LICENSED TO PROVIDE AVC VIDEO. NO LICENSE IS GRANTED OR SHALL BE IMPLIED FOR ANY OTHER USE. ADDITIONAL INFORMATION MAY BE OBTAINED FROM MPEG LA, L.L.C. SEE [HTTP://WWW.MPEGLA.COM](http://www.mpegla.com)

- Android is a trademark of Google Inc.
- The Bluetooth® word mark and logos are registered trademarks owned by Bluetooth SIG, Inc. and any use of such marks by JVC KENWOOD Corporation is under license. Other trademarks and trade names are those of their respective owners.

DIVX

- This DivX Certified® device has passed rigorous testing to ensure it plays DivX® video. To play purchased DivX movies, first register your device at vod.divx.com. Find your registration code in the DivX VOD section of your device setup menu. (Page 50)
- DivX Certified® to play DivX® video, including premium content.
- DivX®, DivX Certified® and associated logos are trademarks of DivX, LLC and are used under license.



**Declaration of Conformity with regard to the EMC Directive
Declaration of Conformity with regard to the R&TTE Directive 1999/5/EC
Declaration of Conformity with regard to the RoHS Directive 2011/65/EU**

Manufacturer:

JVC KENWOOD Corporation
3-12 Moriya-cho, Kanagawa-ku, Yokohama-shi, Kanagawa, 221-0022, Japan

EU Representative:

JVC Technical Services Europe GmbH
Konrad-Adenauer-Allee 1-11, D-61118 Bad Vilbel, Germany

English

Hereby, JVC KENWOOD declares that this unit “KW-V420BT/KW-V320BT/KW-V220BT” is in compliance with the essential requirements and other relevant provisions of Directive 1999/5/EC.

Français

Par la présente JVC KENWOOD déclare que l'appareil “KW-V420BT/KW-V320BT/KW-V220BT” est conforme aux exigences essentielles et aux autres dispositions pertinentes de la directive 1999/5/EC.

Par la présente, JVC KENWOOD déclare que ce “KW-V420BT/KW-V320BT/KW-V220BT” est conforme aux exigences essentielles et aux autres dispositions de la directive 1999/5/EC qui lui sont applicables.

Deutsch

Hiermit erklärt JVC KENWOOD, dass sich dieser “KW-V420BT/KW-V320BT/KW-V220BT” in Übereinstimmung mit den grundlegenden Anforderungen und den anderen relevanten Vorschriften der Richtlinie 1999/5/EC befindet. (BMW) Hiermit erklärt JVC KENWOOD die Übereinstimmung des Gerätes “KW-V420BT/KW-V320BT/KW-V220BT” mit den grundlegenden Anforderungen und den anderen relevanten Festlegungen der Richtlinie 1999/5/EC. (Wien)

Nederlands

Hierbij verklaart JVC KENWOOD dat het toestel “KW-V420BT/KW-V320BT/KW-V220BT” in overeenstemming is met de essentiële eisen en de andere relevante bepalingen van richtlijn 1999/5/EC. Bij deze verklaart JVC KENWOOD dat deze “KW-V420BT/KW-V320BT/KW-V220BT” voldoet aan de essentiële eisen en aan de overige relevante bepalingen van Richtlijn 1999/5/EC.

Italiano

Con la presente JVC KENWOOD dichiara che questo “KW-V420BT/KW-V320BT/KW-V220BT” è conforme ai requisiti essenziali ed alle altre disposizioni pertinenti stabilite dalla direttiva 1999/5/EC.

Español

Por medio de la presente JVC KENWOOD declara que el “KW-V420BT/KW-V320BT/KW-V220BT” cumple con los requisitos esenciales y cualesquiera otras disposiciones aplicables o exigibles de la Directiva 1999/5/EC.

Português

JVC KENWOOD declara que este “KW-V420BT/KW-V320BT/KW-V220BT” está conforme com os requisitos essenciais e outras disposições da Directiva 1999/5/EC.

Polska

JVC KENWOOD niniejszym oświadcza, że “KW-V420BT/KW-V320BT/KW-V220BT” spełnia zasadnicze wymogi oraz inne istotne postanowienia dyrektywy 1999/5/EC.

Český

JVC KENWOOD tímto prohlašuje, že tento “KW-V420BT/KW-V320BT/KW-V220BT” je ve shodě se základními požadavky a dalšími příslušnými ustanoveními směrnice 1999/5/EC.

Magyar

Alulírott, JVC KENWOOD, kijelenti, hogy a jelen “KW-V420BT/KW-V320BT/KW-V220BT” megfelel az 1999/5/EC irányelvben meghatározott alapvető követelményeknek és egyéb vonatkozó előírásoknak.

Svenska

Härmed intygar JVC KENWOOD att denna “KW-V420BT/KW-V320BT/KW-V220BT” står i överensstämmelse med de väsentliga egenskapskrav och övriga relevanta bestämmelser som framgår av direktiv 1999/5/EC.

Suomi

JVC KENWOOD vakuuttaa täten että “KW-V420BT/KW-V320BT/KW-V220BT” tyypinen laite on direktiivin 1999/5/EC oleellisten vaatimusten ja sitä koskevien direktiivin muiden ehtojen mukainen.

Slovensko

S tem JVC KENWOOD izjavlja, da je ta “KW-V420BT/KW-V320BT/KW-V220BT” v skladu z osnovnimi zahtevami in ostalimi ustreznimi predpisi Direktive 1999/5/EC.

Slovensky

Spoločnosť JVC KENWOOD týmto vyhlasuje, že “KW-V420BT/KW-V320BT/KW-V220BT” spĺňa základné požiadavky a ďalšie príslušné ustanovenia Direktívy 1999/5/EC.

Dansk

Undertegnede JVC KENWOOD erklærer herved, at følgende udstyr “KW-V420BT/KW-V320BT/KW-V220BT” overholder de væsentlige krav og øvrige relevante krav i direktiv 1999/5/EC.

Ελληνικά

ΜΕ ΤΗΝ ΠΑΡΟΥΣΑ JVC KENWOOD ΔΗΛΩΝΕΙ ΟΤΙ “KW-V420BT/KW-V320BT/KW-V220BT” ΣΥΜΜΟΡΦΩΝΕΤΑΙ ΠΡΟΣ ΤΙΣ ΟΥΣΙΩΔΕΙΣ ΑΠΑΙΤΗΣΕΙΣ ΚΑΙ ΤΙΣ ΛΟΙΠΕΣ ΣΧΕΤΙΚΕΣ ΔΙΑΤΑΞΕΙΣ ΤΗΣ ΟΔΗΓΙΑΣ 1999/5/EC.

Eesti

Sellega kinnitab JVC KENWOOD, et see “KW-V420BT/KW-V320BT/KW-V220BT” vastab direktiivi 1999/5/EC põhilistele nõudmistele ja muudele asjakohastele määrustele.

Latviešu

Ar šo, JVC KENWOOD, apstiprina, ka “KW-V420BT/KW-V320BT/KW-V220BT” atbilst Direktīvas 1999/5/EC galvenajām prasībām un citiem tās nosacījumiem.

Lietuviškai

Šiuo, JVC KENWOOD, pareiškia, kad šis “KW-V420BT/KW-V320BT/KW-V220BT” atitinka pagrindinius Direktyvos 1999/5/EC reikalavimus ir kitas svarbias nuostatas.

Malti

Hawnhekk, JVC KENWOOD, jiddikjara li dan “KW-V420BT/KW-V320BT/KW-V220BT” jikkonforma mal-htigijiet essenzjali u ma provvediment i oħrajn relevanti li hemm fid-Direttiva 1999/5/EC.

Українська

Компанія JVC KENWOOD заявляє, що цей виріб “KW-V420BT/KW-V320BT/KW-V220BT” відповідає ключовим вимогам та іншим пов’язаним положенням Директиви 1999/5/EC.

Türkçe

Bu vesileyle JVC KENWOOD, “KW-V420BT/KW-V320BT/KW-V220BT” ünitesinin, 1999/5/EC Direktifinin başlıca gereksinimleri ve diğer ilgili hükümleri ile uyumlu olduğunu beyan eder.

Hrvatski

Ovime JVC KENWOOD izjavljuje da je ova jedinica “KW-V420BT/KW-V320BT/KW-V220BT” je u skladu s osnovnim zahtjevima i drugim relevantnim odredbama Direktive 1999/5/EC.

JVC