

JVC

INSTRUCTIONS (BASIC)

HD MEMORY CARD CAMERA RECORDER

GY-HM660U/GY-HM660E

GY-HM660RE

GY-HM620U/GY-HM620E

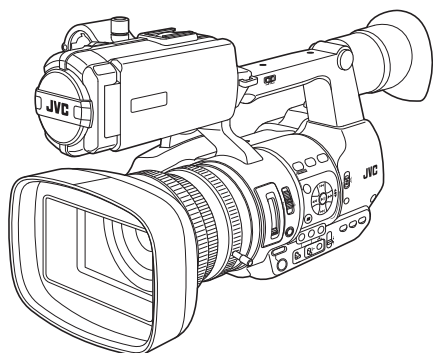

AVCHD™ Progressive

This manual provides a brief explanation on operating this camera recorder. For detailed operation methods and camera settings, please refer to the “INSTRUCTIONS” provided in the supplied CD-ROM or the following Mobile User Guide.

The specifications and appearance of this product are subject to changes for further improvement without prior notice.

Please check the latest version of the INSTRUCTIONS from the following Mobile User Guide. You can also download the PDF from the Mobile User Guide.

Mobile User Guide

When you are outside, you can refer to the instructions from your Android phone or iPhone.

<http://manual3.jvckenwood.com/pro/mobile/global/>

You can view the Mobile User Guide using the browser on your Android phone or iPhone.



For Customer Use:

Enter below the Serial No. which is located on the body.

Retain this information for future reference.

Model No. GY-HM660U/GY-HM620U

Serial No. _____

Please read the following before getting started:

Thank you for purchasing this product. Before operating this unit, please read the instructions carefully to ensure the best possible performance.

In this manual, each model number is described without the last letter (U/E) which means the shipping destination. (U: for USA and Canada, E: for Europe) Only “U” models (GY-HM660U/GY-HM620U) have been evaluated by UL.

FOR USA

These are general **IMPORTANT SAFEGUARDS** and certain items may not apply to all appliances.

IMPORTANT SAFEGUARDS

1. Read these instructions.
2. Keep these instructions.
3. Heed all warnings.
4. Follow all instructions.
5. Do not use this apparatus near water.
6. Clean only with dry cloth.
7. Do not block any ventilation openings. Install in accordance with the manufacturer's instructions.
8. Do not install near any heat sources such as radiators, heat registers, stoves, or other apparatus (including amplifiers) that produce heat.
9. Protect the power cord from being walked on or pinched particularly at plugs, convenience receptacles, and the point where they exit from the apparatus.
10. Only use attachments/accessories specified by the manufacturer.
11. Use only with the cart, stand, tripod, bracket, or table specified by the manufacturer, or sold with the apparatus.
When a cart is used, use caution when moving the cart/apparatus combination to avoid injury from tip-over.
12. Unplug this apparatus during lightning storms or when unused for long periods of time.
13. Refer all servicing to qualified service personnel.
Servicing is required when the apparatus has been damaged in any way, such as power-supply cord or plug is damaged, liquid has been spilled or objects have fallen into the apparatus, the apparatus has been exposed to rain or moisture, does not operate normally, or has been dropped.

**CAN ICES-3 A / NMB-3 A**

Safety Precautions

FOR USA AND CANADA



CAUTION

RISK OF ELECTRIC SHOCK
DO NOT OPEN



CAUTION:
TO REDUCE THE RISK OF ELECTRIC SHOCK.
DO NOT REMOVE COVER (OR BACK).
NO USER-SERVICEABLE PARTS INSIDE. REFER SERVICING TO QUALIFIED SERVICE PERSONNEL.



The lightning flash with arrowhead symbol, within an equilateral triangle is intended to alert the user to the presence of uninsulated “dangerous voltage” within the product’s enclosure that may be of sufficient magnitude to constitute a risk of electric shock to persons.



The exclamation point within an equilateral triangle is intended to alert the user to the presence of important operating and maintenance (servicing) instructions in the literature accompanying the appliance.

This device complies with Part 15 of FCC Rules. Operation is subject to the following two conditions: (1) This device may not cause harmful interference, and (2) this device must accept any interference received, including interference that may cause undesired operation.

Changes or modifications not approved by JVC could void the user’s authority to operate the equipment. This equipment has been tested and found to comply with the limits for a Class A digital device, pursuant to Part 15 of the FCC Rules. These limits are designed to provide reasonable protection against harmful interference when the equipment is operated in a commercial environment.

This equipment generates, uses, and can radiate radio frequency energy and, if not installed and used in accordance with the instructions, may cause harmful interference to radio communications. Operation of this equipment in a residential area is likely to cause harmful interference in which case the user will be required to correct the interference at his own expense.

POUR CANADA**ATTENTION**

RISQUE
D'ELECTROCUTION
NE PAS OUVRIR



ATTENTION:
POUR EVITER TOUT RISQUE
D'ELECTROCUTION NE PAS
OUVRIR LE BOITIER. AUCUNE
PIECE INTERIEURE N'EST A
REGLER PAR L'UTILISATEUR. SE
REFERER A UN AGENT QUALIFIE
EN CAS DE PROBLEME.



Le symbole de l'éclair à l'intérieur d'un triangle équilatéral est destiné à alerter l'utilisateur sur la présence d'une "tension dangereuse" non isolée dans le boîtier du produit. Cette tension est suffisante pour provoquer l'électrocution de personnes.



Le point d'exclamation à l'intérieur d'un triangle équilatéral est destiné à alerter l'utilisateur sur la présence d'opérations d'entretien importantes au sujet desquelles des renseignements se trouvent dans le manuel d'instructions.

Ces symboles ne sont utilisés qu'aux Etats-Unis.

CAUTION:

The mains plug shall remain readily operable.

- Remove the mains plug immediately if the camera functions abnormally.

WARNING:

The battery pack, the camera with battery installed, and the remote control with battery installed should not be exposed to excessive heat such as direct sunlight, fire or the like.

WARNING: TO PREVENT FIRE OR SHOCK HAZARD, DO NOT EXPOSE THIS UNIT TO RAIN OR MOISTURE.

AVERTISSEMENT : POUR EVITER LES RISQUES D'INCENDIE OU D'ELECTROCUTION, NE PAS EXPOSER L'APPAREIL A LA PLUIE NI A L'HUMIDITE.

NOTES:

- The rating plate and safety caution are on the bottom and/or the back of the main unit.
- The serial number plate is on the bottom of the unit.
- The rating information and safety caution of the AC adapter are on its upper and lower sides.

REMARQUES :

- La plaque d'identification et l'avertissement de sécurité se trouvent sous l'appareil et/ou au dos.
- La plaque du numéro de série est située sur la partie inférieure de l'appareil.
- Les informations d'identification et l'avertissement de sécurité de l'adaptateur secteur sont situés sur ses côtés supérieur et inférieur.

Caution on Replaceable lithium battery

The battery used in this device may present a fire or chemical burn hazard if mistreated.

Do not recharge, disassemble, heat above 100°C (212°F) or incinerate.

Replace battery with Panasonic, Sanyo, Sony or Maxell CR2025.

Danger of explosion or risk of fire if the battery is incorrectly replaced.

- Dispose of used battery promptly.
- Keep away from children.
- Do not disassemble and do not dispose of in fire.

When the equipment is installed in a cabinet or on a shelf, make sure that it has sufficient space on all sides to allow for ventilation (10 cm (3-15/16") or more on both sides, on top and at the rear). Do not block the ventilation holes. (If the ventilation holes are blocked by a newspaper, or cloth etc. the heat may not be able to get out.) No naked flame sources, such as lighted candles, should be placed on the apparatus. When discarding batteries, environmental problems must be considered and the local rules or laws governing the disposal of these batteries must be followed strictly.

The apparatus shall not be exposed to dripping or splashing and that no objects filled with liquids, such as vases, shall be placed on the apparatus.

Do not point the lens directly into the sun. This can cause eye injuries, as well as lead to the malfunctioning of internal circuitry. There is also a risk of fire or electric shock.

CAUTION!

The following notes concern possible physical damage to this unit and to the user.

Carrying or holding this unit by the LCD monitor can result in dropping the unit, or in a malfunction.

Do not use a tripod on unsteady or unlevel surfaces. It could tip over, causing serious damage to the unit.

CAUTION!

Connecting cables (Audio/Video, etc.) to this unit and leaving it on top of the TV is not recommended, as tripping on the cables will cause the unit to fall, resulting in damage.

When using the AC adapter in areas other than the USA

The provided AC adapter features automatic voltage selection in the AC range from 110 V to 240 V.

USING HOUSEHOLD AC PLUG ADAPTER

In case of connecting the unit's power cord to an AC wall outlet other than American National Standard C73 series type, use an AC plug adapter called a "Siemens Plug" as shown.

For this AC plug adapter, please contact the local dealers in your area.

Plug Adapter

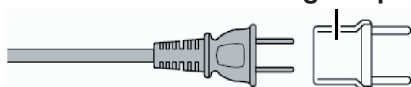

- Remove the AC adapter from the AC wall outlet when not in use.
- Do not leave dust or metal objects adhered to the AC wall outlet or AC adapter (power/DC plug).

IMPORTANT (for owners in the U.K.) Connection to the mains supply in the United Kingdom.

DO NOT cut off the mains plug from this equipment.

If the plug fitted is not suitable for the power points in your home or the cable is too short to reach a power point, then obtain an appropriate safety approved extension lead or contact the local dealers in your area.

BE SURE to replace the fuse only with an identical approved type, as originally fitted, and to replace the fuse cover.

If nonetheless the mains plug is cut off be sure to remove the fuse and dispose of the plug immediately, to avoid possible shock hazard by inadvertent connection to the mains supply.

If this product is not supplied fitted with a mains plug then follow the instructions given below:

DO NOT make any connection to the Larger Terminal coded E or Green. The wires in the mains lead are coloured in accordance with the following code:

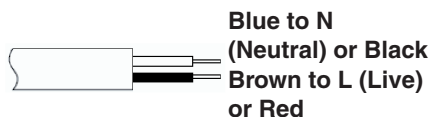

If these colours do not correspond with the terminal identifications of your plug, connect as follows:

Blue wire to terminal coded N (Neutral) or coloured black.

Brown wire to terminal coded L (Live) or coloured Red.

If in doubt — consult a competent electrician.

CAUTIONS:

- To prevent shock, do not open the cabinet. No user serviceable parts inside.
Refer servicing to qualified personnel.
- When you are not using the AC adapter for a long period of time, it is recommended that you disconnect the power cord from AC outlet.

FOR EUROPE

This equipment is in conformity with the provisions and protection requirements of the corresponding European Directives. This equipment is designed for professional video appliances and can be used in the following environments:

- Controlled EMC environment (for example, purpose-built broadcasting or recording studio), and rural outdoors environments.

In order to keep the best performance and furthermore for electromagnetic compatibility we recommend to use cables not exceeding the following lengths:

Port	Cable	Length
DC INPUT	Exclusive Cable	1.8 m
USB Mini	Shielded Cable	1.2 m
AV OUT	Exclusive Cable	1.4 m
HDMI	Shielded Cable	3 m
REMOTE	Exclusive Cable	1 m
HD/SD SDI	Coaxial Cable	3 m
AUDIO INPUT 1/2	Shielded Cable	2 m
HEADPHONE	Exclusive Cable	3 m
AUX	Shielded Cable	2 m
TC	Shielded Cable	1 m

The inrush current of this apparatus is 4.9 A.

CAUTION:

Where there are strong electromagnetic waves or magnetism, for example near a radio or TV transmitter, transformer, motor, etc., the picture and the sound may be disturbed. In such case, please keep the apparatus away from the sources of the disturbance.

Dear Customer

This apparatus is in conformance with the valid European directives and standards regarding electromagnetic compatibility and electrical safety. European representative of JVC KENWOOD Corporation is: JVC KENWOOD Deutschland GmbH Konrad-Adenauer-Allee 1-11 61118 Bad Vilbel GERMANY

Sehr geehrter Kunde, sehr geehrte Kundin, dieses Gerät stimmt mit den gültigen europäischen Richtlinien und Normen bezüglich elektromagnetischer Verträglichkeit und elektrischer Sicherheit überein. Die europäische Vertretung für die JVC KENWOOD Corporation ist: JVC KENWOOD Deutschland GmbH Konrad-Adenauer-Allee 1-11 61118 Bad Vilbel DEUTSCHLAND

CAUTION:

To avoid electric shock or damage to the unit, first firmly insert the small end of the power cord into the AC Adapter until it is no longer wobbly, and then plug the larger end of the power cord in to an AC outlet.

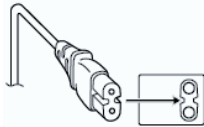

FOR EUROPEAN

WARNING

This equipment is compliant with Class A of CISPR 32. In residential environment this equipment may cause radio interference.

The plastics packaging bags may cause suffocation when they are covered over the head. Tear them open, and keep them away from the reach of infants and children by ensuring that they are disposed of properly.

Battery Pack

The supplied battery pack is a lithium-ion battery. Before using the supplied battery pack or an optional battery pack, be sure to read the following cautions:

- **To avoid hazards**
 - ... **do not** burn.
 - ... **do not** short-circuit the terminals. Keep it away from metallic objects when not in use.
 - When transporting, carry the battery in a plastic bag.
 - ... **do not** modify or disassemble.
 - ... **do not** expose the battery to temperatures exceeding 60°C (140°F), as this may cause the battery to overheat, explode or catch fire.
 - ... use only specified chargers.
- **To prevent damage and prolong service life**
 - ... do not subject to unnecessary shock.
 - ... charge within the temperature range of 10°C to 30°C (50°F to 86°F). Cooler temperatures require longer charging time, or in some cases stop charging at all. Warmer temperatures prevent complete charging, or in some cases stop charging at all.
 - ... store in a cool, dry place. Extended exposure to high temperatures will increase natural discharge and shorten service life.
 - ... keep a 30% battery level () if the battery pack is not to be used for a long period of time.
 - ... remove from charger or powered unit when not in use, as some machines use current even when switched off.
 - ... do not drop or subject to strong impact.

Terminals

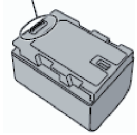

■ Para Brasil

Informação sobre eliminação de baterias

Este produto não deverá ser eliminado como lixo doméstico em geral.

Devolva a bateria velha ao comerciante ou para a rede autorizada, para que seja devolvida ao fabricante ou importador.

A reciclagem e eliminação de lixo em uma maneira adequada, ajudarão para preservar recursos, prevenindo, ao mesmo tempo, contra efeitos prejudiciais sobre a nossa saúde e o meio ambiente.

Para Retirar a Bateria Recarregável

Pressione botão e puxe a bateria para fora.

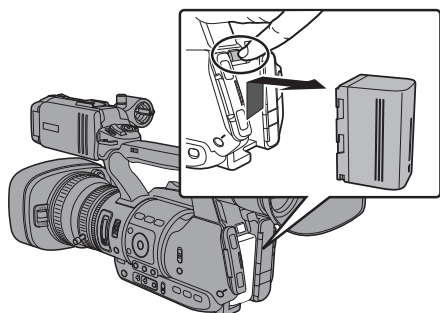

Importer (EU only)

JVCKENWOOD U.K. Limited
12 Priestley Way, London NW2 7BA,
UNITED KINGDOM

Importeur (Nur EU)

JVCKENWOOD Deutschland GmbH
Konrad-Adenauer-Allee 1-11, 61118 Bad Vilbel,
DEUTSCHLAND

Importatore (Solo EU)

JVCKENWOOD Italia S.p.A.
Via G. Sirtori 7/9, 20129 Milano, ITALIA

Importador (Solamente EU)

JVCKENWOOD Ibérica, S.A.
Ctra. Rubí, 88 Edificio Can Castanyer, 08174
Sant Cugat del Valles, Barcelona, ESPAÑA

Importeur (Alleen EU)

JVCKENWOOD Belgium N.V.
Leuvensesteenweg 248J, 1800 Vilvoorde,
BELGIQUE

Importeur (Alleen EU)

JVCKENWOOD Europe B.V.
Amsterdamseweg 37, 1422 AC Uithoorn,
NEDERLAND

Manufacturer

JVCKENWOOD Corporation

3-12, Moriya-cho, Kanagawa-ku, Yokohama-shi,
Kanagawa, 221-0022, JAPAN

Contents

Introduction

Safety Precautions	3
Contents	9
Verifying the Accessories	9
Names of Parts	10

Preparations

Adjusting the Grip Belt	13
Attaching the Large Eyecup	13
Charging the Battery	13
Opening/Closing the Lens Cover	14
Attaching/Detaching the Hood	15
Configuring the Initial Settings	15
Usable Cards	17
Estimated Recordable Time of SD Cards	17
Inserting an SD Card	17

Shooting

Basic Shooting Procedures	20
Miscellaneous Functions for Shooting and Recording Methods	21

Playback

Playing Recorded Clips	22
------------------------------	----

Connecting External Devices

Connecting External Monitor	23
Loading Clips to the PC	24

Network Functions **660**

Functions of Network Connection 660	25
--	----

Others

Menu Screen Hierarchical Chart	26
Basic Operations in Menu Screen	27
Display Screen	28
Status Screen	35
Troubleshooting	36
Precautions for Proper Use	38
Specifications	42
Software License Agreement	44
Important Notice concerning the Software	46

Content of this Manual

Symbols used

- Caution** : Describes precautions concerning the operation of this product.
- Memo** : Describes reference information, such as functions and usage restrictions of this product.
- 660** : Feature available on GY-HM660U/GY-HM660E/GY-HM660RE only.
- 620** : Feature available on GY-HM620U/GY-HM620E only.
- GPS** : Feature available on models with built-in GPS only (GY-HM660U/GY-HM660E).

Verifying the Accessories

Verify that the following accessories are included with the camera recorder before using.

Accessories	
Warranty Card (U model only)	1
INSTRUCTIONS (BASIC)	1
Document and Software Disc	1
AC Adapter	1
Power Cord (U model: 1, E model: 2)	
Battery	1
Large Eyecup	1

Names of Parts

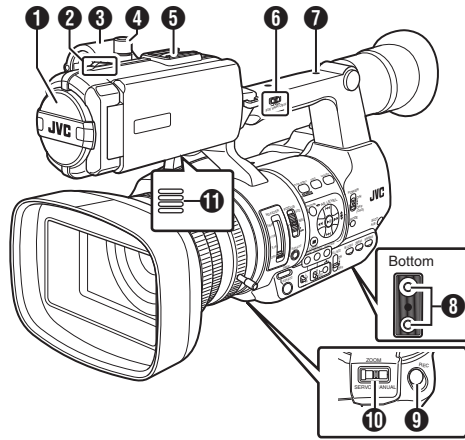

- ❶ Built-in Microphone
 - ❷ Tally Lamp
 - ❸ Microphone Holder
 - ❹ Microphone Holder Lock Knob
 - ❺ Shoe
 - ❻ [FIX/VAR/OFF] Zoom Speed Switch
 - ❼ Accessory Mounting Screw Hole
 - ❽ Tripod Mounting Hole
 - ❾ [REC] Record Trigger Button
-
- Memo : _____
- This button is interlocked with the [REC] button ❾ on the grip and the [REC/HOLD] button ❷ at the top of the handle.
-
- ❿ [ZOOM SERVO/MANUAL] Zoom Operation Servo/Manual Switch
 - ⓫ Monitor Speaker
 - ⓬ Viewfinder
 - ⓭ Visibility Adjustment Lever
 - ⓮ Eyecup
 - ⓯ Battery
 - ⓰ [Ⓜ] Headphone Jack (Φ3.5 mm)
 - ⓱ [AUX] AUX Input Terminal (Φ3.5 mm)
 - ⓲ [REC] Record Trigger Button
-
- Memo : _____
- This button is interlocked with the [REC] button ❾ at the bottom of the lens and the [REC/HOLD] button ❷ at the top of the handle.

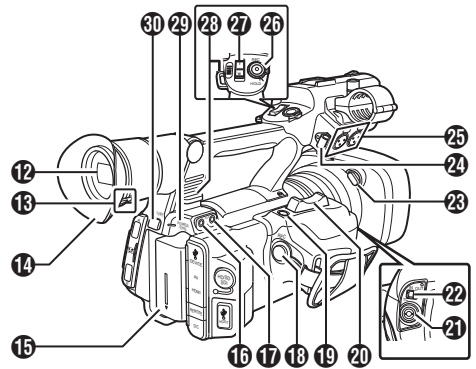

- ⓲ [REC] Record Trigger Button
 - ⓳ [C.REVIEW/7] Clip Review/User 7 Button
 - ⓴ Zoom Lever at the Grip
 - ⓵ [TC] TC Input/Output Terminal
 - ⓶ [IN/OUT] TC IN/OUT Selection Switch
 - ⓷ Hood Release Button
 - ⓸ External Microphone Cable Clamp
 - ⓹ [INPUT1/INPUT2] Audio Input Terminal 1, 2 (XLR 3-pin x 2)
 - ⓺ [REC/HOLD] Record Trigger Button/Lock Switch
-
- Memo : _____
- This button is interlocked with the [REC] button ❾ on the grip and the [REC] button ❾ at the bottom of the lens.
 - The [REC] button ❾ on the grip and the [REC] button ❾ at the bottom of the lens will not be locked.
-
- ⓻ Zoom lever at the Handle
 - ⓼ Shoulder Belt Mount (x2)
-
- Caution : _____
- Be sure to use a shoulder belt with the strength to withstand the weight of this camera recorder.
 - If the shoulder belt is not properly attached, the camera recorder may fall and cause injuries. Check the instruction manual provided with the shoulder belt before using.
-
- ⓽ [POWER/CHG] Power/Charging Display Lamp
 - ⓿ [BATT. RELEASE] Battery Lock Release Button

Side Control Panel

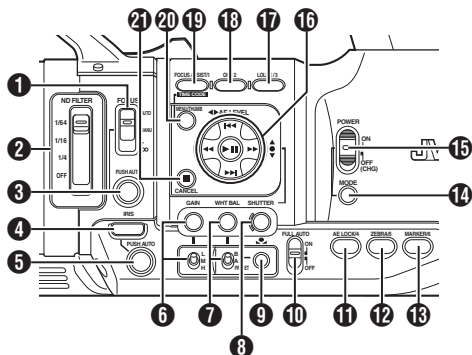

- 1 [FOCUS AUTO/MANU/∞] Focus Switch
- 2 [ND FILTER] ND Filter Switch
- 3 [PUSH AUTO] Focus Push Auto Button
- 4 [IRIS] Iris Auto/Manual Selection Button
- 5 [PUSH AUTO] Iris Push Auto Button
- 6 [GAIN] Gain Auto/Manual Selection Button / [L/M/H] Sensitivity Selection Switch
- 7 [WHT BAL] White Balance Auto/Manual Selection Button / [B/A/PRESET] Selection Switch
- 8 [SHUTTER] Shutter Speed Auto/Manual Selection Button
- 9 [One Push Auto] One Push Auto White Balance Button
- 10 [FULL AUTO ON/OFF] Full Auto Switch
- 11 [AE LOCK/4] AE Lock/User 4 Button
- 12 [ZEBRA/5] Zebra/User 5 Button
- 13 [MARKER/6] Marker/User 6 Button
- 14 [MODE] Camera/Media Mode Selection Button
- 15 [POWER ON/OFF(CHG)] Lock Power ON/OFF Switch
- 16 Cross-Shaped Button (▲▼◀▶)/Set Button (●)
- 17 [LOLUX/3] Low-light Shooting/User 3 Button
- 18 [OIS/2] Optical Image Stabilizer/User 2 Button
- 19 [FOCUS ASSIST/1] Focus Assist/User 1 Button
- 20 [MENU/THUMB] Menu/Thumbnail Button
- 21 [CANCEL] Cancel Button

SD Slot

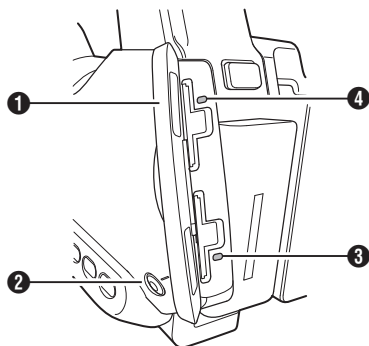

- 1 SD Card Cover
- 2 [SLOT A/B] Card Slot Selection Button
- 3 Card Slot B Status Indicator
- 4 Card Slot A Status Indicator

Rear Terminal

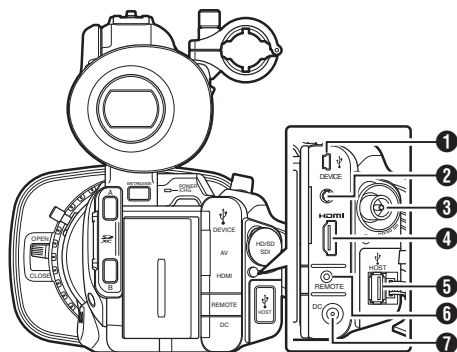

- 1 [DEVICE] USB Mini Terminal
- 2 [AV] AV Output Terminal
- 3 [HD/SD SDI] SDI Output Terminal (BNC)
- 4 [HDMI] HDMI Output Terminal
- 5 [HOST] USB Host Terminal **660**
- 6 [REMOTE] Remote Terminal
- 7 [DC] DC Input Terminal

LCD Monitor

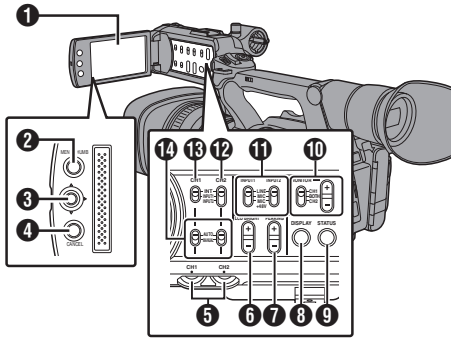

- ❶ LCD Monitor
- ❷ [MENU/THUMB] Menu/Thumbnail Button
- ❸ LCD Cross-Shaped Button (▲▼◀▶)/Set Button (●)
- ❹ [CANCEL] Cancel Button
- ❺ [CH1/CH2] CH1/CH2 Recording Level Adjustment Knob
- ❻ [LCD BRIGHT +/-] LCD Display Brightness Adjustment Button
- ❼ [PEAKING +/-] LCD/VF Contour Adjustment Button
- ❽ [DISPLAY] Display Button
- ❾ [STATUS] Status Screen Display Button
- ❿ [MONITOR]/[+/-] Audio Monitor Selection Switch/Volume Adjustment Button
- ⓫ [INPUT1/INPUT2] Audio Input Signal Selection Switch
- ⓬ [CH2] CH2 Audio Input Signal Selection Switch
- ⓭ [CH1] CH1 Audio Input Signal Selection Switch
- ⓮ [CH1/CH2 AUTO/MANUAL] CH1/CH2 Audio Recording Mode Switch

Lens Section

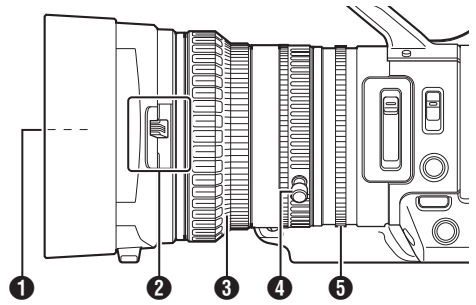

- ❶ Filter Built-In Screw
 - Installable filter types: $\Phi 72\text{mmP}0.75$

Memo :

- Remove the lens hood when installing the filter.
- ❷ Lens Cover Open/Close Switch
 - ❸ Focus Ring
 - ❹ Zoom Ring
 - ❺ Iris Ring

Adjusting the Grip Belt

Open the pad and adjust the position of the grip belt accordingly.

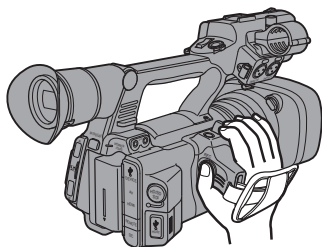

Caution :

- If the grip is loose, the camera recorder may fall off resulting in injuries or malfunction.

Attaching the Large Eyecup

- Attach the large eyecup (supplied) to prevent external light from entering the viewfinder screen and cameraman's vision.
- Align and attach to the groove of the eyecup mounted on the camera recorder.
- The large eyecup can be attached in any direction.

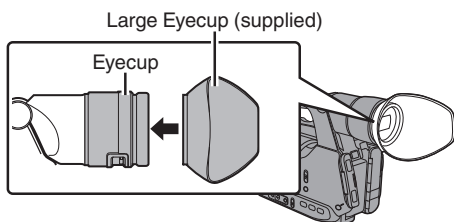

Memo :

- Do not remove the eyecup that is premounted on the camera recorder.

Charging the Battery

Charging the Battery

Charge the battery immediately after purchase or when the battery power is running low.

* The battery is not charged when purchased.

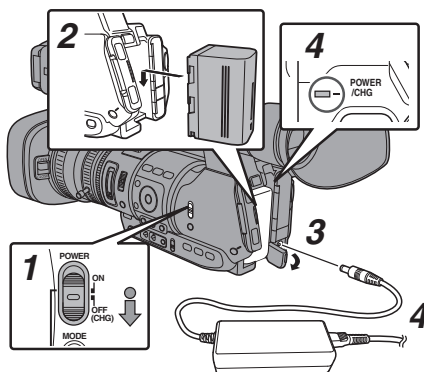

- 1 Hold down the lock button (blue) at the center of the [POWER ON/OFF(CHG)] switch to set to "OFF(CHG)".**
- 2 Attach the supplied battery.**
Slide it in until you hear a click.
- 3 Connect the supplied AC adapter to the [DC] terminal.**
Open the cover of the [DC] terminal and connect as shown in the diagram.
- 4 Connect the AC adapter to a power outlet.**
 - The [POWER/CHG] lamp blinks during charging and will go out after charging is complete.
 - Remove the AC adapter after charging is complete.

Memo :

- Blinking of the [POWER/CHG] lamp during charging indicates the charge level.

[POWER/CHG] Lamp	Charge Level
Orange blinking (4 times per second)	Less than 25 %
Orange blinking (3 times per second)	Less than 50 %
Orange blinking (2 times per second)	Less than 75 %
Orange blinking (1 time per second)	Less than 100 %
Light goes out	Fully charged

- You can charge the battery even when operating the camera recorder using the AC adapter.

Removing the Battery

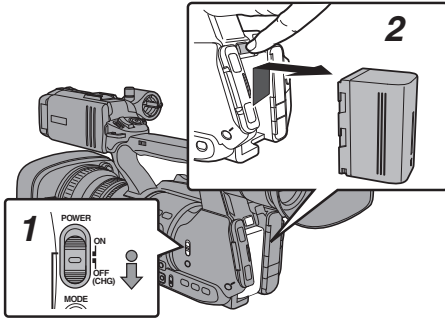

- 1 Hold down the lock button (blue) at the center of the [POWER ON/OFF(CHG)] switch to set to "OFF(CHG)".
- 2 While pressing and holding the [BATT. RELEASE] button, push up and remove the battery in the direction of the arrow.

Caution :

- Do not remove the battery when the [POWER ON/OFF(CHG)] switch is "ON".
- Do not insert or remove the DC cable when the battery is in use.
- Leaving the camera recorder unused with the battery inside will deplete the battery power even if you set the [POWER ON/OFF(CHG)] switch to "OFF(CHG)". Remove the battery if you are not using the camera recorder.

Estimated Charging and Continuous Operating Times

- Charging Time (supplied SSL-JVC50 battery pack)
Approx. 4 hrs

* When the [POWER ON/OFF(CHG)] switch is set to "OFF(CHG)"

Memo :

- If you charge the battery immediately after using while the battery is still warm, it may not be fully charged.
- For details, refer to the "INSTRUCTIONS" of the battery.

- Continuous Operating Time (supplied SSL-JVC50 battery pack)
Approx. 3 hrs **660**
Approx. 3 hrs 20 mins **620**

Memo :

- Actual operating times may differ depending on the age of the battery, charging condition, and operating environment.
- Operating time is shortened in cold environment.
- The operating time may shorten when power zoom is used, accessories are connected, or when the LCD monitor is frequently used.
- For purchase of spare batteries and battery charger, please contact the local dealers in your area.

- Store the battery in a cool and dry place when not in use. Do not expose the battery to high temperatures (such as in a car under direct sunlight). Failure to do so not only shortens the battery life but also damages the battery.

Opening/Closing the Lens Cover

Use the lens cover open/close switch to open or close the lens cover.

Before shooting, open the lens cover.

When this camera recorder is not in use, close the lens cover to protect the lens.

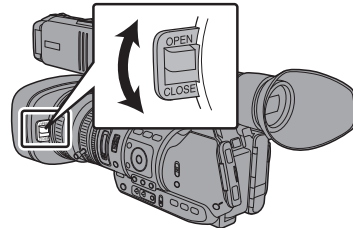

Caution :

- Do not press against the lens cover with force. Doing so may damage the lens or the cover.

Attaching/Detaching the Hood

Attaching the Hood

Align the markings on the camera recorder and hood; turn the hood in the direction of the arrow until it is locked.

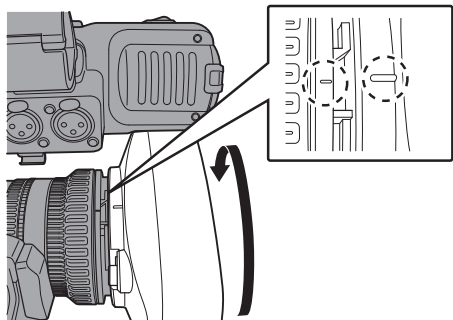

Detaching the Hood

- Remove the hood when attaching a filter, teleconverter or wide converter to the front of the lens.
- While pressing the hood release button, turn the hood in the direction of the arrow (anti-clockwise) to remove it.

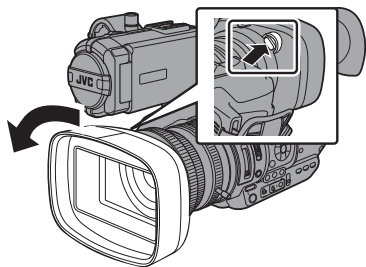

Configuring the Initial Settings

When the power is first turned on, the Initial Setting screen for performing the initial settings in the camera recorder appears.

Set the date/time of the built-in clock in the [Initial Setting] screen.

All operations are disabled until initial settings are complete.

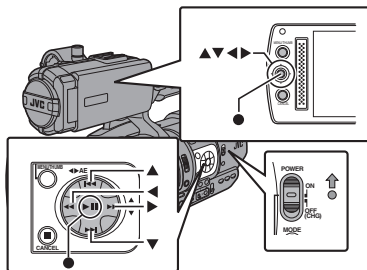

Memo : _____

- It is recommended to use the AC adapter as the power supply.
- Be sure to close the lens cover.

1 Hold down the lock button (blue) at the center of the [POWER ON/OFF(CHG)] switch to set to "ON".

A language selection screen appears.

- For U models

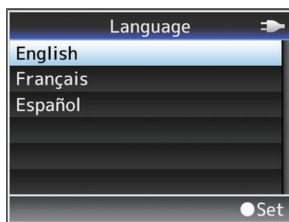

- For E models

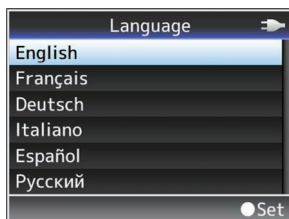

Memo : _____

- The menus and messages on the screen of the LCD monitor or viewfinder are displayed in the selected language.

2 Select a language using the cross-shaped button (▲▼), and press the Set button (●).
The Initial Setting screen appears.

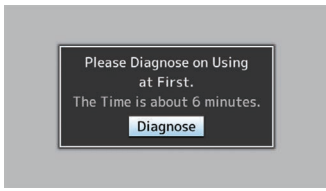

3 Ensure that the lens cover is closed, and press the Set button (●).

- Self-diagnosis starts.
- A progress bar appears, and “Complete Diagnosis” appears when the diagnosis is complete.

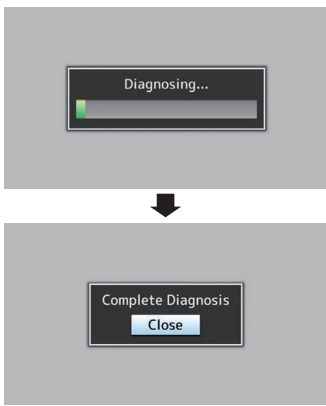

Memo : _____

- It takes about 6 minutes to complete the diagnosis. During the diagnosis, do not operate or turn off the camera recorder.

4 Press the Set button (●) after confirming the exit screen.

The [Initial Setting] screen appears.

- For U models

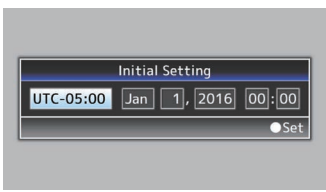

- For E models

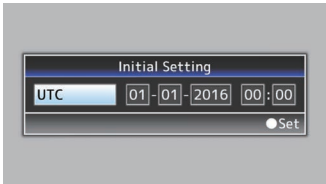

Memo : _____

- The [Initial Setting] screen appears when the power is turned on for the first time and when the power is turned on after the built-in battery is fully discharged.
- The configured date/time data is saved in the built-in rechargeable battery even if the power is turned off.

5 Set the time zone and date/time.

- ① Move the cursor with the cross-shaped button (◀▶) and select the setting item.
- ② Change the values with the cross-shaped button (▲▼).

6 Press the Set button (●) after setting is complete.

The clock is set to 0 seconds of the input date/time.

Memo : _____

- The configured date/time data can be displayed on the LCD monitor and viewfinder and be recorded to the SD card.
- The value of the year can be set in the range of “2000” to “2099”.

Usable Cards

Use a Class 6/10 SD card.

Memo : _____

- Depending on the recording format, SD card with Class 4 or higher performance can also be used.
- To use an SDHC card, set [4GB File Spanning(SDXC)] to "On".

Caution : _____

- Using cards other than those from Panasonic, TOSHIBA or SanDisk may result in recording failure or data loss.

Estimated Recordable Time of SD Cards

The estimated recordable time is only a guide. Differences may occur depending on the SD card in use and the battery condition.

	QuickTime/MP4/MXF		
	MPEG2/HD		
	SP		HQ
	720p	1080i	720p/1080i/1080p
4 GB	22	17	12
8 GB	45	35	25
16 GB	90	70	50
32 GB	180	140	100
64 GB (SDXC)	360	280	200
128 GB (SDXC)	720	560	400

(Unit: minute)

	AVCHD				
	HQ	HQ	SP	LP	EP
	1080p		1080i		
4 GB	16	19	25	46	82
8 GB	33	39	50	95	168
16 GB	67	78	100	190	336
32 GB	135	156	200	380	672
64 GB (SDXC)	270	312	400	760	1344
128 GB (SDXC)	540	624	800	1520	2688

(Unit: minute)

	QuickTime				
	H.264/HD		H.264/SD	H.264/Web	
	XHQ	UHQ	-	HQ	LP
	1080i/1080p		480i/576i	960p	480p
4 GB	9	12	47	130	285
8 GB	18	25	95	270	580
16 GB	36	50	190	540	1160
32 GB	72	100	380	1080	2320
64 GB (SDXC)	145	200	760	2160	4720
128 GB (SDXC)	290	400	1520	4320	9440

(Unit: minute)

Memo : _____

- If the SD card contains files recorded by devices other than this camera recorder or files that are saved from a PC, the recordable time may be shorter or data may not be properly recorded.
- The number of clips that can be recorded to one SD card on this camera recorder for each file format is restricted.

Up to 600 clips can be recorded for the "QuickTime" file format and 4000 clips for the "AVCHD" file format. When the maximum number of clips is reached, the remaining space is displayed as "0 min" regardless of the estimated recordable time, and no further recording can be made.

Inserting an SD Card

This camera recorder comes with two card slots (Slot A and B) for video/audio recording and playback.

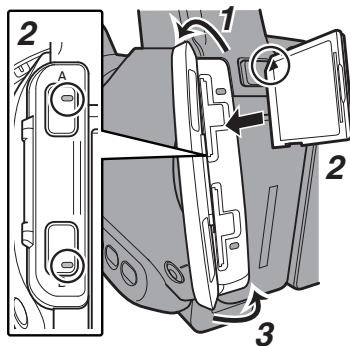

- 1 Open the SD card cover.
- 2 Insert an SD card with the notched corner pointing up.
The status indicator of the card slot to which the card was inserted lights up in red.
- 3 Close the SD card cover.

Formatting (Initializing) SD Cards

When the following cards are inserted, [!FORMAT] appears at the remaining media display area. Format the card using the camera recorder menu.

- Unformatted SD cards
- SD cards formatted under different specifications

Caution :

- Be sure to format the SD card on this camera recorder. SD cards formatted on a PC and other peripheral equipment cannot be used on this camera recorder.
- [!RESTORE] appears at the remaining media display area when an SD card that requires restoring is inserted.

- 1 Select [System] → [Media] → [Format Media].
- 2 Select the slot of the SD card to be formatted and press the Set button (●).

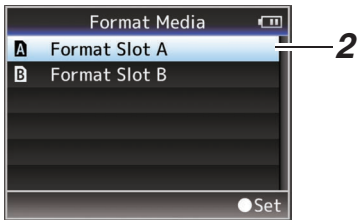

- 3 The status of the selected SD card appears.
- 4 Select [Format] and press the Set button (●).

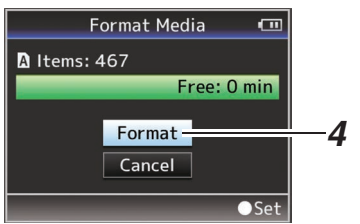

5 Formatting starts.

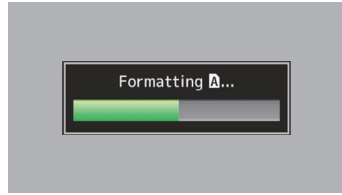

6 Formatting is complete.

When formatting is complete, "Complete" appears and the camera recorder returns to the [Format Media] screen.

Memo :

- During formatting, menu operation is unavailable but you can start recording. However, this is only available when a recordable SD card is inserted in the other slot.
- Formatting cannot be performed in the following cases.
 - Recording is in progress on the SD card to be formatted.
 - SD card is not inserted.
 - Write-protect switch of the SD card is set (🔒 is displayed).

Caution :

- If you format the SD card, all data recorded on the card, including video data and setup files, will be deleted.

Clips Recorded to SD Cards

Folders in the SD Card

Images recorded are sorted into the respective folders according to the menu settings below.

* Select which folder to record to from the menu.

■ **660**

System	A Format/ B Format	Record Folder
HD	QuickTime (MPEG2)	DCIM or PRIVATE/JVC/CQAV*
	MP4(MPEG2)	PRIVATE/JVC/BPAV
	MXF(MPEG2)	PRIVATE/JVC/CMAV
HD/Web	AVCHD	PRIVATE/AVCHD
HD/SD/Web	QuickTime(H.264)	DCIM or PRIVATE/JVC/CQAVC*

■ **620**

System	Format	Record Folder
HD	QuickTime (MPEG2)	DCIM or PRIVATE/JVC/CQAV*
	MP4(MPEG2)	PRIVATE/JVC/BPAV
	AVCHD	PRIVATE/AVCHD
HD/SD	QuickTime(H.264)	DCIM or PRIVATE/JVC/CQAVC*

Memo : _____

- When [System] is set to “HD+Web”, web files (MOV format) will be recorded in the [DCIM] folder. **660**
- By formatting (initializing) the SD card from the [Format Media] menu on the camera recorder, folders required for recording in the current [System] settings will be generated.
- When the [System] settings and [QuickTime(MPEG2)] settings are changed, folders required for recording in those settings will be automatically generated.

Caution : _____

- When a clip inside the folder is moved or deleted using the Explorer (Windows) or Finder (Mac), recording to the SD card may fail if formatting (initializing) of the card is not performed.

Clip (Recorded Data) and Clip Name

- When recording is stopped, the images, audio and accompanying data which are recorded from start to stop are recorded as one “clip” on the SD card.
- An 8-character clip name is automatically generated for the recorded clip. (“Clip Name Prefix” + “Clip Number”)

- When [Main Menu] → [System] → [Record Set] → [Record Format] → [**A**Format] is set to “AVCHD”, the clip name generated consists of only the Clip Number (5-digit number).

Example: In the case of QuickTime/MP4

ABCG0001

Clip Number

A number in automatic ascending order is assigned in the recording order.
The Clip Number can be reset in the menu.*

Clip Name Prefix (any four alphanumeric characters)

This is set to “xxxG” (“xxx” denotes the last 3 digits of the serial number) by default.

* [Clip Set] → [Reset Clip Number]

Memo : _____

- Before recording starts, you can set any characters for the clip name prefix by using [Main Menu] → [System] → [Record Set] → [Clip Set] → [Clip Name Prefix].
- Changes cannot be made after recording.

Recorded Clips

- The recorded materials may be split into several files but they can be played back continuously on the camera recorder.
- Clips may be recorded across the two SD cards in card slots A and B depending on the recording time of the clip.
- When copying videos in MP4 file format to a HDD using a PC, it is recommended to use [JVC ProHD Clip Manager Software], which is found in the supplied disc, to maintain continuity.

Caution : _____

- A clip recorded across several cards cannot be played back continuously. Continuous playback is only possible when the recording is made on one card.

Basic Shooting Procedures

Preparations

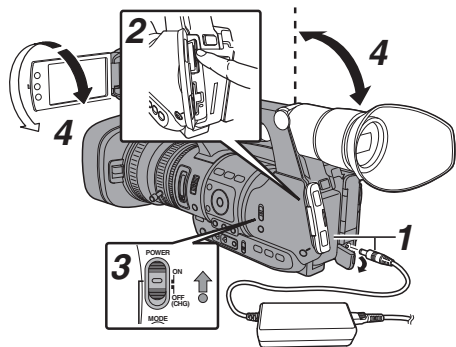

- 1 Supply battery or AC adapter power to the camera recorder.**
- 2 Insert an SD card.**
- 3 Turn on the power of the camera recorder.** Hold down the lock button (blue) at the center of the [POWER ON/OFF(CHG)] switch to set to "ON". The camera recorder starts up in Camera mode and is ready for recording.
- 4 Adjust the angle of the LCD monitor and viewfinder.**
- 5 Configure [System], [Format], [Resolution] and [Frame & Bit Rate] in [Main Menu] → [System] → [Record Set] → [Record Format].**
 - You can select the definition of the recorded videos (HD, SD or Web **660**), file format for recording/playback, and the video recording format on this camera recorder.
 - Press the [MENU/THUMB] button on the LCD monitor to display the menu screen on the LCD monitor and viewfinder.
 - The following setting values are the factory defaults.
[System]: HD
[Format]: QuickTime(MPEG2)
[Resolution]: 1920x1080
[Frame & Bit Rate]: 60i(HQ) (U model) or 50i(HQ) (E model)

Shooting

1 Configure the video and audio input settings.

You have to configure video settings such as brightness adjustment (iris, gain, shutter) and white balance adjustment in order to start shooting. You also have to adjust the audio input settings and audio recording level for audio recording.

- Adjusting the Brightness
- Adjusting the White Balance
- Adjusting Audio Input Settings and Recording Level

2 Press the [REC] button to start recording to the SD card.

This camera recorder has three [REC] buttons. Any of the [REC] buttons can be used to start/stop recording by default.

- The tally lamp lights up in red during recording.
- Zoom Operation
- Adjusting the Focus

Memo : _____

- If both the slots are loaded with recordable cards in the factory default, pressing the [REC] button starts recording only to the media in the selected slot.
When [Main Menu] → [System] → [Record Set] → [Slot Mode] is set to "Dual", recording can be performed simultaneously to the cards in both the slots.
- The tally lamp can be turned off in [System] → [Tally Lamp].

3 Check the most recently captured images.

- Press the [C.REVIEW/7] button on the lens to activate the Clip Review function. The most recently captured images are played back on the LCD monitor and viewfinder screen.
- After playback, the camera recorder returns to standby mode (STBY).

Memo : _____

- [Clip Review] is assigned to [C.REVIEW/7] button in factory default.
- [Clip Review] can also be assigned to other user buttons.

Miscellaneous Functions for Shooting and Recording Methods

This camera recorder is equipped with various functions for shooting. The functions described here are the typical functions of the camera recorder.

Miscellaneous Functions for Shooting

- **Assignment of user buttons:**
You can assign functions to the buttons and use them as user buttons.
Functions can be assigned to the buttons according to the usability.
- **AF assist:**
Allows you to set the auto focus point to the preferred area or to near and far directions.
- **Focus Assist:**
The focused area is displayed in color to allow easy and accurate focusing.
- **Expanded focus:**
Magnifies the preferred area to enable precise focus to be established easily.
- **Zebra pattern:**
Diagonal lines (zebra pattern) are displayed only at the area with the specified luminance levels.
- **Marker:**
Displays the marker and safety zone when determining the angle of view for the image according to the shooting purpose.

Recording Methods

1 Recording using both slots A and B

- **Continuous recording (Series Rec):**
Enables seamless long hour continuous recordings over the slots.
- **Record simultaneously at the same definition (Dual Rec):**
Allows you to create two clips of the same content at the same time only on this camera recorder.
- **Backup Rec:**
Allows you to record only the preferred scenes to one slot using the record and stop operations while the other slot is continuously recording.

2 Special recording

* Special recording can be specified in conjunction with 1 under given conditions.

- **Pre Rec:**
Enables recording to go back to the specified duration in seconds of the video and audio before the actual recording start time. This allows you to record a complete event without missing the initial scenes even if you start the recording late.
- **Clip Continuous Rec:**
Allows you to consolidate several rounds of "startstop recording" into one clip. You can consolidate the clips while recording when shooting on-and-off and shooting several scenes.
- **Frame Rec:**
Records as a single clip only in the specified frame rate until the recording is stopped. Useful for shooting clay animation.
- **Interval Rec:**
Records and pauses repeatedly at the specified time interval and frame rate, and records as a single clip until the recording is stopped. Useful for observation recording.
- **Variable Frame Rec:**
Enables the making of smooth slow motion or fast motion videos by setting a recording frame rate that is different from the playback frame rate during shooting.

3 Other recordings

- **Clip cutter trig:**
You can split the clips freely without having to stop recording during shooting.

Playing Recorded Clips

Use the operation buttons on the side control panel of the camera recorder to play back.

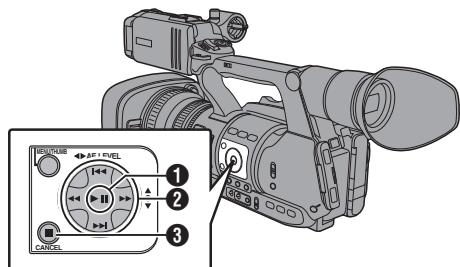

1 ▶▶|| Button

- Plays back/pauses the clip pointed by the cursor.
- You can press the cross-shaped button (◀▶) to perform frame-by-frame forward playback during pause mode.

2 ◀◀▶▶ Button

Skips in the reverse or forward direction.

◀◀▶▶ Button

During Playback:

Fast forwards in the reverse or forward direction.

While paused:

Frame-by-frame playback in the reverse or forward direction.

3 ■ Button

Stops playback.

1 In the thumbnail screen, move the cursor to the clip to be played back.

Move the cursor to the clip to be played back using the cross-shaped button (▲▼◀▶).

2 Press the playback/pause button.

Playback of the selected clip starts.

Audio Output during Playback

- You can confirm the playback sound from the monitor speaker, or the headphone connected to the [Φ] terminal. When a headphone is connected to the [Φ] terminal, sound cannot be output from the monitor speaker.
- Adjust the volume of the monitor speaker and headphone using the [MONITOR +/-] volume adjustment button on the LCD monitor section of the camera recorder.

Time Code Playback

Time code or user's bit recorded on an SD card can be displayed on the LCD monitor and viewfinder.

Memo : _____

- The time code is also superimposed on the video signal output from the [HD/SD SDI] output terminal.
- User's bit output from the [HD/SD SDI] output terminal is used as a flag to determine valid video signals. Therefore, accurate values will not be output.
- If a section without time code is played back, the time code will stop. However, playback will continue.

Displaying Information during Shooting

During playback, pressing the [DISPLAY] button shows the display screen.

Pressing the [AE LOCK/4] button switches the display information during shooting between no display, camera information display, and GPS display.

Connecting External Monitor

- To output live or playback video images and audio sound to an external monitor, select the output signals from the camera recorder, and connect using an appropriate cable according to the monitor to be used.
- Choose the most suitable terminal according to the monitor in use.
- [HD/SD SDI] terminal:
Outputs either the HD-SDI signal or SD-SDI signal.
- [AV] terminal:
Outputs composite video and audio signals.
- [HDMI] terminal:
Outputs HDMI signals.
Configure the settings in the [A/V Set] menu to match the monitor to be connected.

Memo : _____

- When [Network] is set to "On(HDMI Off)" or "On(SDI Off)", either HDMI signal or SDI signal is output. **660**
- If the [HD/SD SDI] terminal or [HDMI] terminal is connected, configure the settings in the [A/V Set] menu according to the monitor to be connected.

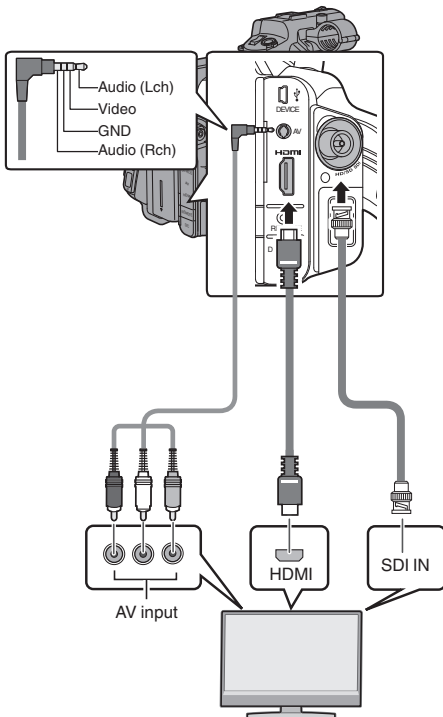

* Select the output signal in [A/V Set] → [HDMI/SDI Out].

* When [Record Format] → [System] is set to "SD", only SD-SDI signals are output.

* To display the menu screen or display screen on an external monitor, set [A/V Set] → [Video Set] → [Display On TV] to "On".

Connecting via SDI

- Digital video signals, together with embedded (superimposed) audio signals and time code signals, are output for both the HD-SDI and SD-SDI signals.
- User's bit output from the [HD/SD SDI] output terminal is used as a flag to determine valid video signals. Therefore, accurate values will not be output.

Memo : _____

- The sampling frequency for embedded (superimposed) audio signals is 48 kHz. Time code of the built-in time generator as well as playback time code are also output.

Setting the Aspect

- For setting the mode to convert images with a 16:9 aspect ratio to display on a 4:3 aspect ratio screen.
- Set using [A/V Set] → [Video Set] → [SD Aspect].
- The available modes include "Side Cut", "Letter" (blackened at the top and bottom), and "Squeeze" (full size, compressed at the left and right).

Memo : _____

- When [Record Format] → [System] is set to "SD", and [SD Aspect] is set to "4:3", this item cannot be selected.

Loading Clips to the PC

- You can load clips to a PC by connecting the camera recorder to the PC via the USB port. Doing so enables clips stored in the SD card to be managed and edited on the PC.
- Files on the SD card can be managed/edited on the connected PC in this mode only for USB mass storage class devices that are recognized by the said PC as a peripheral drive.

Memo : _____

- Files cannot be written to the SD card.
- Make sure to manage/edit files recorded in the MP4 file format using the (JVC ProHD Clip Manager) PC application software in the supplied disc.
- For details on how to install the application software, refer to the [User's Guide] of the [JVC ProHD Clip Manager] inside the supplied disc.

1 Connect the camera recorder to the PC using a USB cable.

A confirmation message "Change to USB Mode?" to enable the USB connection appears.

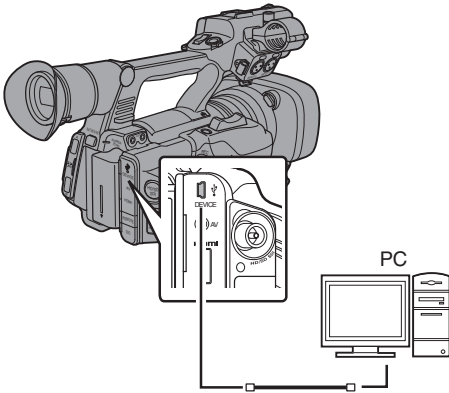

- ## 2 Select [Change] using the cross-shaped button (▲▼), and press the Set button (●). The camera recorder switches to USB mode.



Memo : _____

- If recording is in progress, the "Change to USB Mode?" message appears after recording stops.
- If playback is in progress, the camera recorder switches to USB mode after the file closes automatically, such as when playback stops.

Disconnecting

- Disable the connection on the PC, then remove the USB cable from the camera recorder.
- Doing so exits the USB mode and switches the camera recorder to Camera mode.

Memo : _____

- The procedure for disabling the USB connection varies according to the PC in use. For details, refer to the "INSTRUCTIONS" of the PC.

Functions of Network Connection **660**

- The network function can be operated by connecting one of the following adapters to the rear [HOST] terminal.
 - Wireless LAN adapter
 - Ethernet adapter
 - Cellular adapter
- The network feature comprises web-browser-based functions using devices such as a smartphone, tablet terminal, or PC, as well as FTP and live streaming functions that run via thumbnail screens and menu operation.

| List of Functions

Importing Metadata

You can download a metadata settings file (XML format) from the FTP server and store metadata in the camera recorder.

Uploading Recorded Clips

You can upload clips recorded in the SD card to a preset FTP server.

Memo : _____

- Uploading can also be performed via a web browser.
-

Editing Metadata

- Planning Metadata
You can access the page for editing the camera recorder's metadata via a web browser on devices such as a smartphone, tablet terminal, or PC, and edit the metadata that is to be applied to clips to be recorded.
- Clip Metadata
You can access the page for editing the metadata via a web browser on devices such as a smartphone, tablet terminal, or PC, and display or rewrite the metadata that is recorded to a clip.

View Remote

You can access via a web browser on devices such as a smartphone, tablet terminal, or PC to check the live image or remotely control the camera.

Camera Control

You can access via a web browser on devices such as a smartphone, tablet terminal, or PC to remotely control the camera.

Live streaming

By combining with the set top box decoder or PC application that supports live streaming, you can perform audio and video streaming via the network.

Menu Screen Hierarchical Chart

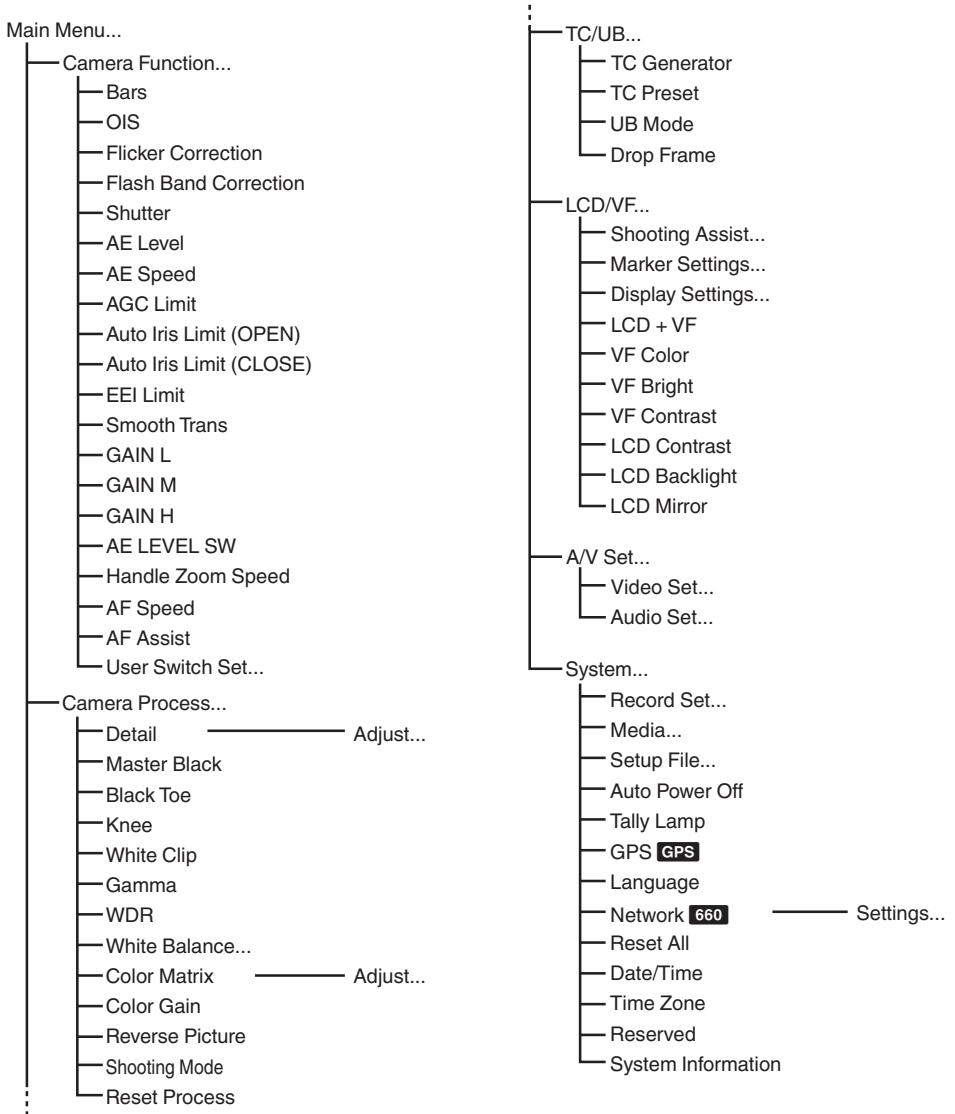

* Only menu items that can be set using this camera recorder are introduced here.
 For details on each item, please refer to "INSTRUCTIONS" provided in the supplied CD-ROM.

Basic Operations in Menu Screen

- Press the [MENU/THUMB] button on the side control panel of the camera recorder or on the LCD monitor to display the menu screen on the LCD monitor and viewfinder.
- Various settings for shooting and playback can be configured on the menu screen.
- There are two types of menu screens - [Main Menu] and [Favorites Menu].
- [Main Menu] contains all the setting items of the camera recorder, classified according to functions and uses, while [Favorites Menu] allows users to customize the menu items freely.
- The operating procedures and main screen displays are the same for both menus.
- The menu screen can also be displayed on external monitors connected to the video signal output terminal.

Operation Buttons

Use the operation buttons on the side control panel of the camera recorder or the buttons on the LCD monitor to operate the menu.

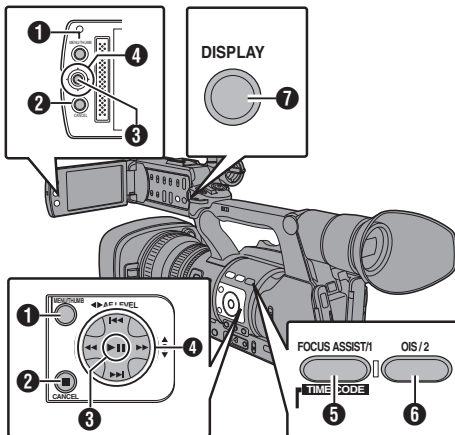

- 1 [MENU/THUMB] Button
 - Displays the menu screen. The [Main Menu] screen is displayed by default.
 - During normal usage, [Main Menu] is displayed if the previous menu operation ended at [Main Menu], and [Favorites Menu] if the previous menu operation ended at [Favorites Menu].
 - Press this button to close the menu screen during menu display and return to the normal screen.
 - Pressing and holding down the button while the menu is displayed switches the [Main Menu] screen to the [Favorites Menu] or vice versa.
- 2 [CANCEL] Button

Cancels settings and returns to the previous screen.
- 3 Set Button (●)

Sets the values and items.
- 4 Cross-shaped Button (▲▼◀▶)
 - ▲ : Moves the cursor upward.
 - ▼ : Moves the cursor downward.
 - ◀ : Moves back to the previous item.
 - ▶ : Moves forward to the next item.
- 5 [FOCUS ASSIST/1] Button

Adds the selected menu or submenu item to the [Favorites Menu].
- 6 [OIS/2] Button

Resets settings in the [TC Preset] or [UB Preset] setting screen. This button is disabled in other screens.
- 7 [DISPLAY] Button

Switches between the [Main Menu] and [Favorites Menu] screens.

Display Screen

Display Screen in Camera Mode

Display 0 screen

This screen displays the event. It is also used to display warnings only.

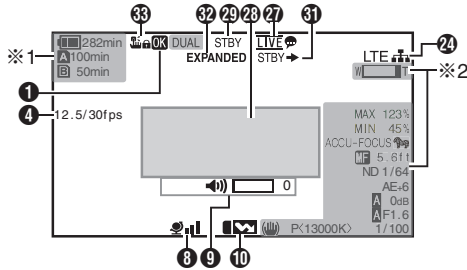

- *1 Appears only during warnings
- *2 Appears only during operation

Display 1 screen

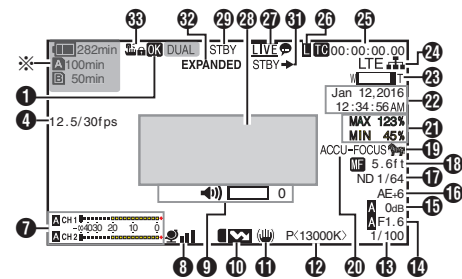

- * Appears only during warnings

Display 2 screen

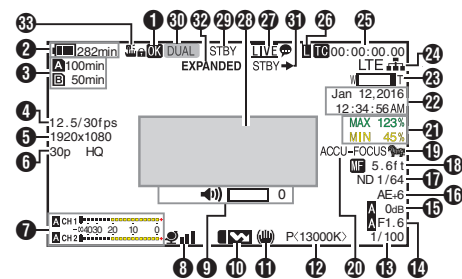

- ① OK Mark
Displayed when OK mark has been appended.
- ② Voltage/Battery Power
Displays the current status of the power supply in use.

Memo : _____

- Displayed in the Display 0 and Display 1 screens during warnings only.

- ③ Remaining Space on Media
Displays the remaining recording time of the SD cards in slot A and slot B separately.

- A** : Currently selected slot. (White card)
- A** : Write-protect switch of SD card is set.
- A**!!INVALID : SD card cannot be read or written to, or restored.
- A**!!FORMAT : SD card requires formatting.
- A**!!RESTORE : SD card requires restoring.
- A**!!INCORRECT :

- When Record Set is set to other than "AVCHD"/"SD"/"Web" with a Class 4 SD card inserted.
- When the SD card is not supported.
- When an SD card lower than Class 10 is inserted while in the XHQ mode.

- A**!!REC INH :
- When attempting to record in 50i(HQ)/50i(SP) to an SD card recorded in AVCHD60i(HQ)/60i(SP) (or vice versa).
- When an SDHC card is inserted while [4GB File Spanning(SDXC)] is set to "Off".

The following icons are displayed during FTP upload. **660**

Icon	Status
	FTP transfer is in progress. Three images are alternately displayed, and the arrows become animated. In this case, instead of the recordable time of the SD card, an estimated value of the remaining transfer time is displayed.
	Error has occurred during FTP transfer. (Yellow)

Memo : _____

- This item is not displayed when [Main Menu] → [LCD/VF] → [Display Settings] → [Media Remain] is set to "Off". However, warnings will be displayed.
- Displayed on the Display 0 and Display 1 screens only in the case of warnings. (When the remaining time is shorter than 3 minutes)
The icons appear on all display screens in the following cases.
 - When recording is performed to only one of the slots while [Main Menu] → [System] → [Record Set] → [Slot Mode] is set to "Dual".
 - When recording is performed to only one of the slots while [Main Menu] → [System] → [Record Set] → [Record Format] → [System] is set to "HD+SD" or "HD+Web". **660**
- The displayed time is an estimate.

4 Variable Frame Rate
Displayed as xx/yy fps (xx: recording frame rate, yy: playback frame rate) only when [Rec Mode] is set to "Variable Frame".

5 Resolution
Displays the video image resolution.

Memo : _____

- This item is not displayed when [Main Menu] → [LCD/VF] → [Display Settings] → [Record Format] is set to "Off".

6 Frame Rate/Bit Rate
Displays the frame rate and bit rate in pairs.

Memo : _____

- This item is not displayed when [Main Menu] → [LCD/VF] → [Display Settings] → [Record Format] is set to "Off".

7 Audio Level Meter

- Displays the audio levels of CH1 and CH2.
- **A** appears on the screen when in the Auto mode.



- When [Main Menu] → [System] → [Record Set] → [Rec Mode] is set to "Frame Rec", "Interval Rec", or "Variable Frame", audio cannot be recorded and is indicated by the  mark.



Memo : _____

- This item is not displayed when [Main Menu] → [LCD/VF] → [Display Settings] → [Audio Meter] is set to "Off".

8 GPS Mark **GPS**
When [Main Menu] → [System] → [GPS] is set to "On", the signal reception status is displayed.

Memo : _____

- The display changes according to the signal reception sensitivity. If signals cannot be received, the  mark appears in yellow.
- This item is not displayed when [GPS] is set to "Off".

9 Volume Operation Indicator
Displayed when there are changes made to the volume of the headphone, speaker (0 to 15), and the values of LCD BRIGHT, PEAKING (-10 to +10).





Memo : _____

- There is no audio output from the speaker in Camera mode.

10 Flash Band Correction Mark
This item is displayed when [Main Menu] → [Camera Function] → [Flash Band Correction] is set to "On".

11 Image Stabilizer Mark
Displayed when the image stabilizer is ON.

-  : When [Level] of [OIS] is set to "Normal".
-  : When [Level] of [OIS] is set to "High".

Memo : _____

- If image stabilizer is set to “OFF” when the Display 0 screen is displayed,  appears for 3 seconds.
- Displayed in the Display 0 screen only when there is a change.

12 White Balance Mode

Displays the current white balance mode.
(****K indicates color temperature)

A<****K> : When the white balance is set to Auto A.

B<****K> : When the white balance is set to Auto B.

P<****K> : When the white balance is set to Preset.

 <FAW> : During Full Auto White Balance mode.

 <FAW> : When [AE LOCK] is set to “On” during Full Auto White Balance mode.

Memo : _____

- Displayed in the Display 0 screen only when there is a change.

13 Shutter

- The current shutter speed is displayed when the shutter is set to “On”.
-  is displayed when the [FULL AUTO] switch is set to “ON” to enable Full Auto shooting mode, or when the [SHUTTER] button is pressed to enable automatic shutter mode.



Memo : _____

- The variable range of the shutter speed varies according to the video format settings.
- Displayed in the Display 0 screen only when there is a change.
- If the shutter speed is not displayed, the shutter is OFF.

14 Iris F-Number

Displays F-number of the lens iris.

15 Gain

- Displays the gain value.
-  is displayed in AGC mode during Manual shooting.
-  is displayed when AE LOCK is set to “ON”.
- “LUX30” or “LUX36” is displayed when in the low-light shooting mode.

Memo : _____

- Displayed in the Display 0 screen only when there is a change.

16 AE Level

- Appears when the AE function is activated, and [Main Menu] → [Camera Function] → [AE Level] is set to a value other than “Normal”.
- When operated while manual operation is disabled, “AE” blinks for about 5 seconds.
- When face detection is enabled and [Face Detect] is set to “AF&AE”,  appears on the left side of “AE”.





17 ND Filter Position

Displays the current ND filter position.

Memo : _____

- This item is not displayed when [Main Menu] → [LCD/VF] → [Display Settings] → [ND Filter] is set to “Off”.
- Displayed in the Display 0 screen only when there is a change.

18 Focus Display

- Displays the approximate distance to the subject in focus during manual focus.
-  is displayed during Auto Focus.
- When face detection is enabled,  appears on the left side of .
- If [Main Menu] → [Camera Function] → [AF Assist] is set to “Area”, the  icon appears on the left side of .

Memo : _____

- You can specify the display method (Feet/ Meter) in [Main Menu] → [LCD/VF] → [Display Settings] → [Focus].
This item will not be displayed when “Off” is selected.
- Displayed in the Display 0 screen only when there is a change.

19 Zebra pattern

During zebra pattern display,  (zebra icon) is displayed on the display screen in Camera mode.

- 20 Focus Assist
- “FOCUS” is displayed when auto focus is activated.
 - When ACCU-Focus is enabled, “ACCU-FOCUS” blinks for about 10 seconds while Focus Assist starts up, after which the “FOCUS” indicator lights up.
 - If recording starts while [ACCU-Focus] is active, [ACCU-Focus] will be forcibly deactivated.

Memo : _____

- Displayed in the Display 0 screen only when there is a change.

- 21 Luminance Information
- Displayed when the Spot Meter function is activated.
- MAX : Maximum luminance
MIN : Minimum luminance

- 22 Date/Time Display
- Displays the current date and time.

Memo : _____





- The date/time display style can be specified in [Main Menu] → [LCD/VF] → [Display Settings] → [Date Style]/[Time Style].
- This item is not displayed when [Main Menu] → [LCD/VF] → [Display Settings] → [Date/Time] is set to “Off”.
- When [Main Menu] → [System] → [Record Set] → [Time Stamp] is set to “On”, this item is not displayed.

- 23 Zoom Display
- Displays the zoom position. (Zoom bar or value)
 - The zoom bar will only be displayed for 3 seconds after the zoom operation is activated.
 - The value will always be displayed. (0 to 99)

Memo : _____

- You can specify the display method (Number/Bar) in [LCD/VF] → [Display Settings] → “Zoom”. This item will not be displayed when “Off” is selected.
- Displayed in the Display 0 screen only when there is a change.

- 24 Network Connection Icon **660**
- When [Main Menu] → [System] → [Network] is set to “On(SDI Off)” or “On(HDMI Off)”, the network connection status is displayed. This icon is not displayed when “Off” is selected.

Icon	Status
 (Blink)	Connection is not established (starting up, preparing for connection)
 (Yellow)	Connection is not established (preparing for connection)
	Connection is established
	When a USB adapter different from the connection settings is detected
(No display)	When an incompatible USB adapter is detected, or when [Network] is set to “Off”

Memo : _____

- When a cellular adapter that supports LTE connection display is in use, “LTE” will appear to the left of the above icon when LTE connection is detected.

- 25 Time Code (TC)/User’s Bit (UB) Display
- Displays the time code (hour: minute: second: frame) or user’s bit data recorded in the SD card being played back.
 - Example of time code display:

TC00:00:00:00

※

* Colon (:) denotes non-drop frames and dot (.) denotes drop frames.

- Example of user’s bit display:



UBFF EE DD 20

Memo : _____



- You can specify whether to display the time code, user's bit, or turn off the display in [LCD/VF] → [Display Settings] → [TC/UB]. This item will not be displayed when "Off" is selected.









26 Time Code Lock Indicator
When the built-in time code generator is synchronized to the external time code data input during the synchronization of time code with another camera recorder,  lights up.

27 Live streaming mark  **660**
When [Main Menu] → [System] → [Network]/[Settings] → [Live Streaming Set] → [Live Streaming] is set to "On", the distribution status is displayed.

Icon	Status
 (Red)	Distribution in progress (good connection quality)
 (Red)	Distribution in progress (poor connection quality)
 (Yellow)	Connection pending or connection failed

28 Event/Warning Display Area
Displays error messages.

- 29** Media Status
- : No card found in the selected slot
- STBY : Recording standby
- REC : Recording
- REVIEW : Clip Review
- STBY  : Pre Rec recording standby
- REC  : Pre Rec recording
- STBY  : Clip Continuous Rec recording standby

- REC  : Clip Continuous Rec recording
- STBY  : Clip Continuous Rec recording pause (displayed in yellow)
- STBY  : Interval Rec recording standby
- STBY  : Interval recording pause (displayed in red)
- REC  : Interval Rec recording
- STBY  : Frame Rec recording standby
- REC  : Frame Rec recording
- STBY  : Frame Rec recording pause (displayed in yellow)
- STOP : Unable to record to the card in the slot
- P.OFF : Power OFF

30 Dual Rec/Backup Rec Display
"DUAL" is displayed in the Dual Rec mode and "BACKUP" is displayed in the Backup Rec mode.

Memo : _____

- This item is not displayed when [Slot Mode] is set to "Series".
- This item is not displayed when [Main Menu] → [LCD/VF] → [Display Settings] → [Media Remain] is set to "Off". However, warnings will be displayed.
- Displayed in the Display 0 and Display 1 screens during warnings only. (When the remaining time is shorter than 3 minutes)

31 Record Trigger

STBY → : When [Rec Trigger] is set to "On" and recording is stopped

REC → : When [Rec Trigger] is set to "On" and recording is in progress

32 Expanded focus
"EXPANDED" (yellow) is displayed during expanded focus.

33 Operation lock
The  icon appears during operation lock.

Display Screen in Media Mode

Media Display 0 Screen

This screen displays the media status or event. It is also used to display warnings only.

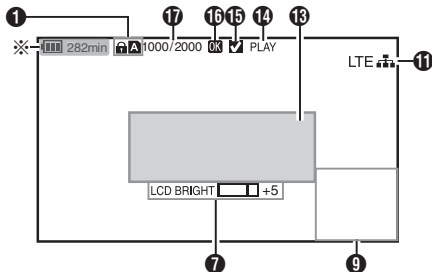

* Appears only during warnings

Media Display 1 Screen

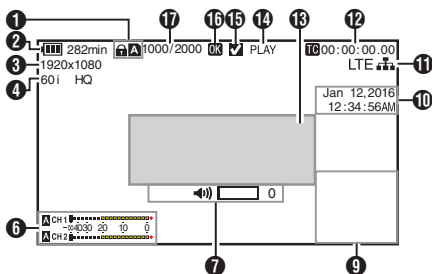

- Media
 - Displays the media slot (A or B) of the currently played clip.
 - Appears when the write-protect switch of the SD card is set.

- Voltage/Battery Power
 - Displays the current status of the power supply in use.

Memo : _____
 • Displayed in the Media Display 0 screen during warnings only.

- Resolution
 - Displays the video image resolution.
- Frame Rate/Bit Rate
 - Displays the frame rate and bit rate in pairs.
- Operation Guide
 - Displays a guide for the current operation buttons.

- Audio Level Meter
 - Displays the audio levels of CH1 and CH2.



Memo : _____
 • This item is not displayed when [Main Menu] → [LCD/VF] → [Display Settings] → [Audio Meter] is set to "Off".

- Volume Operation Indicator
 - Displayed when there are changes made to the volume of the headphone, speaker (0 to 15), and the value of LCD BRIGHT (-10 to +10).

Media Display 2 Screen

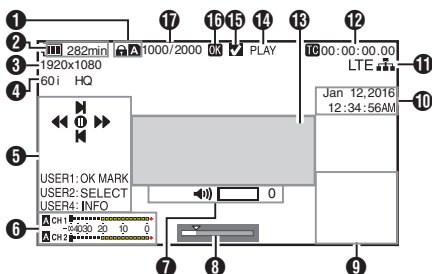

- Position bar
 - Displays the current position in the video. During trimming, the position bar appears in green, and icons for the in and out points are displayed.
 - ▼ : Current position of the video
 - ▲ : Position to start trimming (In point)
 - ▲ : Position to end trimming (Out point)

- 9** Information Display
Use the [AE LOCK/4] button to switch between camera information display, GPS display and turning off the display.
- The GPS display displays information on the recording location of the video being played back only when GPS information has been recorded. The local date/time is displayed.
 - Camera information display displays only information of Gain, Iris, Shutter and White Balance that have been recorded.

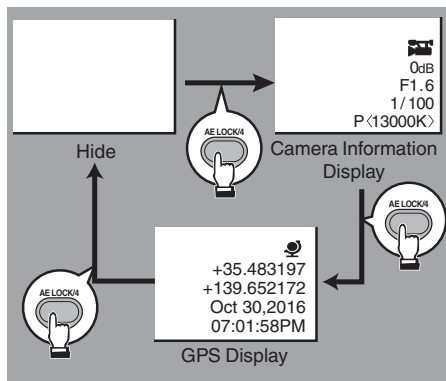

- Memo : _____
- Trimming information is displayed while trimming is in progress. You cannot switch the display using the [AE LOCK/4] button during this process.

- 10** Date/Time Display
Displays the date/time that is recorded on the currently played SD card.

- Memo : _____
- The date/time display style can be specified in [LCD/VF] → [Display Settings] → [Date Style]/[Time Style].

- 11** Network Connection Icon **660**
When [Main Menu] → [System] → [Network] is set to "On(SDI Off)" or "On(HDMI Off)", the network connection status is displayed. This icon is not displayed when "Off" is selected.

Icon	Status
(Blink)	Connection is not established (starting up, preparing for connection)
(Yellow)	Connection is not established (preparing for connection)
	Connection is established
	When a USB adapter different from the connection settings is detected
(No display)	When an incompatible USB adapter is detected, or when [Network] is set to "Off"

- Memo : _____
- When a cellular adapter that supports LTE connection display is in use, "LTE" will appear to the left of the above icon when LTE connection is detected.

- 12** Time Code (TC)/User's Bit (UB) Display
- Displays the time code (hour: minute: second: frame) or user's bit data recorded in the SD card being played back.
 - Example of time code display:

TC00:00:00:00
※

* Colon (:) denotes non-drop frames and dot (.) denotes drop frames.

- Example of user's bit display:

UBFF EE DD 20

- Memo : _____
- You can specify whether to display the time code, user's bit, or turn off the display in [TC/UB] of [Main Menu] → [LCD/VF] → [Display Settings].

- 13 Event/Warning Display Area
Displays error messages.

14 Media Status

- PLAY : Playing
- STILL : Still picture playback mode
- FWD * : High-speed playback in the forward direction (* playback speed: 5x, 15x, 60x, or 360x)
- REV * : High-speed playback in the reverse direction (* reverse playback speed: 5x, 15x, 60x, or 360x)
- STOP : Stop mode
- P.OFF : Power OFF

15 Check Mark

Displayed when the currently played clip is selected.

16 OK Mark

Displayed when OK mark has been appended.

17 Clip Information

Displays current clip number/total number of clips.

Status Screen

- This screen allows you to check the current settings.
- To display the status screen, press the [STATUS] button in the normal screen.
- The status display differs according to the operation mode (two types).
- Press the [STATUS] button to switch to the display screen.
- Press the [MENU/THUMB] button at each status screen (other than the [Camera 1]/[Camera 2] screen) to enter the setting screen.
- Use the cross-shaped button (◀▶) to switch screens as follows:

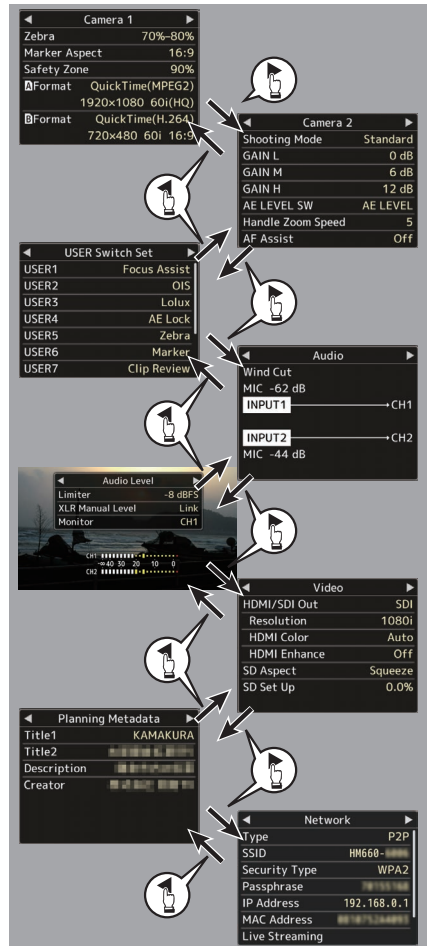

* These are screen examples of GY-HM660. The contents displayed are different depending on the model and settings.

Troubleshooting

Symptom	Action
Power does not turn on.	<ul style="list-style-type: none"> • Is the AC adapter properly connected? • Is the battery charged? • Is the power turned on immediately after it is turned off? Make sure to wait for an interval of at least 5 seconds before turning on the power again.
Unable to start recording.	<ul style="list-style-type: none"> • Is the record trigger button/lock switch on the handle turned on? • Is the write-protect switch of the SD card turned on? Make sure that the write-protect switch is turned off. • Is the camera recorder set to the Camera mode? Use the [MODE] selection button to switch to the Camera mode. • Is the SD card inserted compatible with the recording format?
Camera image is not output on the LCD monitor and viewfinder screen.	<ul style="list-style-type: none"> • Is the camera recorder set to the Camera mode? Use the [MODE] selection button to switch to the Camera mode.
Playback does not start after selecting a clip thumbnail and pressing the Set button (●).	<ul style="list-style-type: none"> • Is the selected clip a playable clip? Playback is not possible if the clip has a different video format setting.
No sound during playback.	<ul style="list-style-type: none"> • Is the currently played clip recorded in the Variable Frame Rec mode?
Images on the LCD monitor and viewfinder screen appear dark or blurred.	<ul style="list-style-type: none"> • Readjust the brightness of the LCD monitor and viewfinder. • Is the [ND FILTER] switch set to "1/64"? • Is the iris closed? • Is the shutter speed setting too high? • Is the amount of peaking too little? Use the [PEAKING +/-] button to adjust the contour for the LCD monitor and the viewfinder screen.
The [CH1/CH2] recording level adjustment knob does not work.	<ul style="list-style-type: none"> • Is the [CH1/CH2 AUTO/MANUAL] switch set to "AUTO"? • Is the [FULL AUTO] switch set to "ON"? Is the [FULL AUTO] switch set to "ON", and [A/V Set] → [Audio Set] → [Audio On FULL AUTO] set to "Auto"?
SD card cannot be initialized (formatted).	<ul style="list-style-type: none"> • Is the write-protect switch of the SD card turned on? Make sure that the write-protect switch is turned off.
Battery alarm appears even after loading a charged battery.	<ul style="list-style-type: none"> • Is the battery too old?

Symptom	Action
The time code and user's bit are not displayed.	<ul style="list-style-type: none"> • Even in Camera mode or Media mode, the time code and user's bit may not be displayed depending to the type of display. • Is [LCD/VF] → [Display Settings] → [TC/UB] set to "Off"? To display the time code or user's bit, set it to "TC" or "UB".
The date and time are not displayed.	<ul style="list-style-type: none"> • The date and time are only displayed on the Display 1 and Display 2 screens in the Camera mode (during shooting). • Is [System] → [Record Set] → [Time Stamp] set to "On"? To display the date and time, set it to "Off".
Incorrect display on the viewfinder.	<ul style="list-style-type: none"> • Is the LCD monitor used with [LCD/VF] → [LCD + VF] set to "Off"?
The actual recording time is shorter than the estimated time.	<ul style="list-style-type: none"> • The recordable time may be shorter depending on the shooting conditions or the subject.
The two camera recorders are not synchronized even though the time codes have been synchronized. (L on the Slave device is not displayed.)	<ul style="list-style-type: none"> • Is the [TC IN/OUT] switch correctly set? • Set [System] → [Record Set] → [Record Format] → [A]Frame & Bit Rate] such that the two camera recorders have the same frame rate.
Cannot connect to wireless LAN. 660	<ul style="list-style-type: none"> • Check the mode of connection and method of setting ([SSID] and [Passphrase] in cases other than WPS). • Even if the Passphrase is wrong, "Completed the Setup Wizard. Please Input the Passphrase into Your Device." may appear at the browser setting depending on the type of encryption. Adjust [Passphrase] again.
The View Remote screen turns black. The screen flickers. The screen freezes. Cannot perform remote operation. 660	<ul style="list-style-type: none"> • The network path is congested. Wait a while before refreshing (reloading) the web browser.
The clips cannot be uploaded to the FTP server. 660	<ul style="list-style-type: none"> • Adjust the [Clip Server] settings. • The maximum size of the recorded clip is 64 GB. If a file size limit is set in the FTP server settings, set the size limit to more than 64 GB.
The wireless LAN is disconnected. 660	<ul style="list-style-type: none"> • The wireless LAN may be disconnected depending on the environment. Change the usage environment. • Connect via wired LAN.
GPS signal cannot be received. GPS	<ul style="list-style-type: none"> • Signal reception from GPS satellites may be affected by buildings or trees. Perform positioning preferably at an unobstructed location with a clear view.
The position is not accurate. GPS	<ul style="list-style-type: none"> • The precision error may be up to hundreds of meters if the GPS signal is weak or reflected off surrounding buildings.
The images and audio sound during live streaming are choppy. 660	<ul style="list-style-type: none"> • Depending on the type of network adapter used and the connection, streaming may not be possible with the encoding bit rate specified. Please reduce the encoding bit rate.

Precautions for Proper Use

Storage and Usage Locations

- Allowable ambient temperature and humidity
Be sure to use this unit within the allowable temperature range of 0 °C to 40 °C (32 °F to 104 °F) and a relative humidity of 30 % to 80 %. Using this unit at a temperature or humidity outside the allowable ranges could result not only in malfunction but also serious impact on the CMOS elements as small white spots may be generated. Please exercise care during use.
- Strong electromagnetic waves or magnetism
Noise may appear in the picture or audio and/or the colors may be incorrect if this unit is used near a radio or television transmitting antenna, in places where strong magnetic fields are generated by transformers, motors, etc., or near devices emitting radio waves, such as transceivers or cellular phones.
- Use of wireless microphone near this unit
When a wireless microphone or wireless microphone tuner is used near this unit during recording, the tuner could pick up noise.
- Avoid using or placing this unit in the following places.
 - Places subject to extreme heat or cold
 - Places with excessive dirt or dust
 - Places with high humidity or moisture
 - Places subject to smoke or vapor such as near a cooking stove
 - Places subject to strong vibrations or unstable surfaces
 - In a parked car under direct sunlight or near a heater for long hours
- Do not place this unit at places that are subject to radiation or X-rays, or where corrosive gases occur.
- Protect this unit from being splashed with water. (Especially when shooting in the rain)
- Protect this unit from getting wet when shooting on a beach. In addition, salt and sand may adhere to the body. Be sure to clean the unit after use.
- Protect this unit against penetration of dust when using it in a place subject to sandy dust.

Carrying the Camera

- Do not drop or hit this unit against a hard object when transporting.

Power Saving

- When this unit is not in use, be sure to set the [POWER ON/OFF(CHG)] switch to "OFF(CHG)" in order to reduce power consumption.

Maintenance

- Turn off the power before performing any maintenance.
- Wipe the external cabinet of the unit with a soft cloth. Do not wipe the body with benzene or thinner. Doing so may cause the surface to melt or turn cloudy. When it is extremely dirty, soak the cloth in a solution of neutral detergent, wipe the body with it, and then use a clean cloth to remove the detergent.

Rechargeable Battery

- Be sure to use only the specified batteries. We do not guarantee the safety and performance of this device if an unspecified battery is used.
- For details, refer to the "INSTRUCTIONS" of the battery.

ATTENTION:



The product you have purchased is powered by a rechargeable battery that is recyclable. Please call 1-800-8-BATTERY for information on how to recycle this battery.

Regular Inspection (Maintenance)

- Under normal environment, dust will accumulate on the camera recorder when it is used over a long period. Dust may enter the camera recorder especially if it is used outdoors. This may affect the image and sound quality of the camera recorder. Check and replace the fan after every 9000 hours (suggested guideline). You can check the usage time of the fan in [System] ➔ [System Information] ➔ [Fan Hour]. If the fan is used for more than 9000 hours without replacement, "Fan Maintenance Required" will be displayed every time you turn on the power.

Encryption in Network Connection 660

- Wireless LAN connections make use of an encryption function. This encryption is designed for commercially-sold equipment, and it cannot be altered.

SDHC/SDXC Cards

- SDHC/SDXC card is referred to as SD card in this manual.
- This camera recorder saves the recorded images and audio sound on the SD card (sold separately) in the card slot.
- If the SD card contains files recorded by devices other than this camera recorder or files that are saved from a PC, the recordable time may be shorter or data may not be properly recorded. In addition, the remaining space on the card may not increase even when files are deleted using a PC.
- For details on the combinations of usable SD card and format setting, refer to the following.

* Using cards other than those from Panasonic, TOSHIBA or SanDisk may result in recording failure or data loss.

Handling of SD Cards

- The status indicator lights up in red when data on the SD card is being accessed. Do not remove the SD card during data access (such as recording, playback, or formatting). Do not turn off the power or remove the battery and AC adapter during access either.
- Do not use or store the SD card in a place that is subject to static electricity or electrical noise.
- Do not place the SD card near locations that are exposed to strong magnetic fields or radio waves.
- Inserting the SD card incorrectly may result in damage of this unit or the SD card.
- We are not liable for any accidental loss of data stored on the SD card. Please back up any important data.
- Make use of the SD card within the prescribed conditions of use. Do not use it at the following locations. Places that are subject to direct sunlight, high humidity or corrosion, places near thermal equipment, sandy or dusty places, or in a car under the sun with the doors and windows closed.
- Do not bend or drop the SD card, or subject it to strong impact or vibration.
- Do not splash the SD card with water.
- Do not dismantle or modify the SD card.
- Do not touch the terminals with your hands or with a metal object.
- Do not allow dust, dirt, water, or foreign objects to adhere to the terminals.
- Do not remove the labels or stick other labels or stickers on the SD cards.

- Do not use pencils or ballpoint pens to write on the SD cards. Always use oil-based pens.
- If you format (initialize) the SD card, all data recorded on the card, including video data and setup files, will be deleted.
- You are recommended to use cards that are formatted (initialized) on this camera recorder.
 - The SD card may be damaged if the camera recorder is not operated correctly. Formatting (Initializing) the SD card may allow it to operate correctly.
 - SD cards that have been formatted (initialized) on other cameras, computers or peripheral equipment may not operate correctly. In this case, format (initialize) the SD card on this camera recorder.
- If you want to wipe out all information by completely erasing the data, we recommend either using commercially available software that is specially designed for that purpose, or by physically destroying the SD card with a hammer, etc. When formatting or erasing data using the camera recorder, only the file administration information is changed. The data is not completely erased from the SD card.
- Some commercially available SD cards may be harder to be removed from this unit. Remove them by hooking onto the groove on the cards.
 - It will be easier to remove the cards after several times.
 - Do not stick any stickers on the cards.



- The SD card may pop out when it is being removed. Be careful not to lose the card.

GPS **GPS**

- The GPS (Global Positioning System) satellites are managed by the Department of State of the U.S., and its precision may be altered intentionally.
- Perform positioning at an unobstructed location with a clear view that is not indoors or blocked by trees.
- The time needed for obtaining the position information may be longer and variation may also be larger depending on the surrounding environment and time of day.
- This camera recorder uses the WGS 84 World Geodetic System.
- Signal from GPS satellites may be interrupted by communication signal from electronic devices such as mobile phones.

LCD Monitor and Viewfinder

- The LCD monitor and viewfinder screen are manufactured using high-precision technology. Black spots may appear on the LCD monitor and viewfinder screen, or red, blue, and/or white spots may not disappear. However, this is not a malfunction and these spots are not recorded on the SD card.
- If you use this unit continuously for a long period of time, the characters displayed in the viewfinder may temporarily remain on the screen. This is not recorded on the SD card. They will not appear after you turn the power off and then on again.
- If you use this unit in a cold place, the images may appear to lag on the screen, but this is not a malfunction. Retained images are not recorded on the SD card.
- Do not press against the surface with force or subject it to strong impact. Doing so may damage or break the screens.
- Noise may appear in the viewfinder when switching between the live video and playback images.
- Due to the characteristic of the viewfinder display device, colors may appear on the images when you blink your eyes. It does not affect the recorded images, SDI output, or HDMI output.

License Notices

- MPEG LA AVC
THIS PRODUCT IS LICENSED UNDER THE AVC PATENT PORTFOLIO LICENSE FOR THE PERSONAL USE OF A CONSUMER OR OTHER USES IN WHICH IT DOES NOT RECEIVE REMUNERATION TO
(i) ENCODE VIDEO IN COMPLIANCE WITH THE AVC STANDARD (“AVC VIDEO”) AND/OR
(ii) DECODE AVC VIDEO THAT WAS ENCODED BY A CONSUMER ENGAGED IN A PERSONAL ACTIVITY AND/OR WAS OBTAINED FROM A VIDEO PROVIDER LICENSED TO PROVIDE AVC VIDEO.
NO LICENSE IS GRANTED OR SHALL BE IMPLIED FOR ANY OTHER USE. ADDITIONAL INFORMATION MAY BE OBTAINED FROM MPEG LA, L.L.C. SEE
[HTTP://WWW.MPEGLA.COM](http://www.mpegla.com)

- MPEG LA MPEG-2 Patent
ANY USE OF THIS UNIT IN ANY MANNER OTHER THAN PERSONAL USE THAT COMPLIES WITH THE MPEG-2 STANDARD FOR ENCODING VIDEO INFORMATION FOR PACKAGED MEDIA IS EXPRESSLY PROHIBITED WITHOUT A LICENSE UNDER APPLICABLE PATENTS IN THE MPEG-2 PATENT PORTFOLIO, WHICH LICENSE IS AVAILABLE FROM MPEG LA, LLC, 6312 S. WHICH LICENSE IS AVAILABLE FROM MPEG LA, LLC, 6312 S. Fiddlers Green circle, Suite 400E, Greenwood Village, Colorado 80111 U.S.A.

Copyright

- Any recordings made on this camera recorder that are played back for profit or public preview may infringe on the rights of the owner of the recordings.
Do not use the recordings for purpose other than personal enjoyment without prior consent from the owner.

Others

- Do not insert objects other than the memory card into the card slot.
- Do not block the vent on the unit.
Blocking of the vent causes internal heating and may lead to burns and fires.
- Do not turn off the [POWER ON/OFF(CHG)] switch or remove the power cable during recording or playback.
- The camera recorder may not show stable pictures for a few seconds immediately after the power is turned on, but this is not a malfunction.
- When the video signal output terminals are not in use, put on the covers to prevent damage to the terminals.
- Do not drop this unit or subject it to strong impact or vibration as it is a precision equipment.
- Optical performance of lens
Due to the optical performance of the lens, color divergence phenomena (magnification chromatic aberration) may occur at the periphery of the image. This is not a camera malfunction.
- Noise may appear in the image when switching modes.
- If placed on its side, heat release efficiency will deteriorate.
- Use the supplied AC adapter as the power supply. Do not use the supplied AC adapter on other devices.
- When the connectors that come with connector covers are not in use, put on the covers to prevent damage to the connectors.
- This camera recorder makes use of fonts by Fontworks Inc.
- This camera recorder makes use of M+ FONTS.

Content of this manual



- All rights reserved by JVC KENWOOD Corporation. Unauthorized duplication or reprinting of this manual, in whole or in part, is strictly prohibited.
- Illustrated designs, specifications and other contents of this manual are subject to change for improvement without prior notice.
- AVCHD Progressive and the AVCHD Progressive logo are trademarks of Panasonic Corporation and Sony Corporation.
- XDCAM EX is a trademark of Sony Corporation.
- SDXC and SDHC logos are trademarks of SD-3C, LLC.
- HDMI (High-Definition Multimedia Interface) and  are trademarks of HDMI Licensing, LLC.
- QuickTime, Final Cut Pro, iPhone, iPad, iPod touch, iOS, Mac OS and Safari are trademarks of Apple Inc., registered in the U.S. and other countries.
- Android, Google Chrome and Nexus are trademarks and/or registered trademarks of Google Inc.
- QR Code is a registered trademark of Denso Wave Incorporated.
- Dolby and the double-D symbol are trademarks of Dolby Laboratories.
- Microsoft, Windows, Windows Vista, and Internet Explorer are either registered trademarks or trademarks of Microsoft Corporation in the United States and/or other countries.
- Surface is the trademarks of Microsoft Corporation in the United States and/or other countries.
- Mozilla and Firefox are either trademarks or registered trademarks of Mozilla Foundation in the United States and/or other countries.
- The company name of Fontworks, Fontworks, and the name of the fonts are registered trademarks of Fontworks Inc.
- Zixi and the Zixi logo are trademarks of Zixi LCC.
- Other product and company names included in this instruction manual are trademarks and/or registered trademarks of their respective companies. Marks such as [™] and [®] have been omitted in this manual.

Specifications

General

Item	Description
Power	DC 12 V
Power consumption	Approx. 12 W 660 Approx. 10 W 620 (When recording in the factory default settings using the viewfinder.)
Mass	Approx. 2.5 kg (with battery) 660 Approx. 2.4 kg (with battery) 620
Allowable operating temperature	0 °C to 40 °C (32 °F to 104 °F)
Allowable operating humidity	30 %RH to 80 %RH
Allowable storage temperature	-20 °C to 50 °C (-4 °F to 122 °F)
Dimensions (W × H × D)	177.5 mm × 197 mm × 415.5 mm

Terminal Section

Item	Description
[HD/SD SDI] output terminal (480i or 576i: Downconverted; 720p/1080i: embedded audio), BNC (unbalanced)	
HD-SDI	Compliant with SMPTE ST292
SD-SDI	Compliant with SMPTE ST259
[HDMI] Output Terminal	Type A
[INPUT1/INPUT2] terminal	
[MIC]	-50 dBu, 3 kΩ, XLR (balanced), +48 V output (phantom power supply)
[LINE]	+4 dBu, 10 kΩ, XLR (balanced)
[AUX] terminal	-22 dBu, 10 kΩ, 3.5 mm stereo mini jack (unbalanced)
[AV] terminal	Φ3.5 mm 4-pin mini jack
Video signal	1.0 V (p-p)
Audio signal	-8 dBu (during reference level input), 1 kΩ (unbalanced)
[] terminal	Φ3.5 mm mini jack (stereo)
[REMOTE] terminal	Φ2.5 mm mini jack (stereo)
[] terminal	
[DEVICE]	Mini USB-B type, USB 2.0, slave function (mass storage class) only
[HOST] 660	USB-A type, USB2.0, network connection function only

Item	Description
[TC] terminal	
[IN]	1.0 V (p-p) to 4.0 V (p-p) high impedance
[OUT]	2.0 ± 1.0 V (p-p) low impedance

Lens Section

Item	Description
Lens	Fujinon F1.6, 23x, f=4.1 mm to 94.3 mm (35 mm conversion: 29 mm to 667 mm)
Filter diameter	Φ72 mm

Camera Section

Item	Description
Image pickup device	1/3-inch Progressive CMOS
Color separation prism	F1.6, 3-color separation prism
Sync system	Internal sync (built-in SSG)
Optical filter	OFF, 1/4, 1/16, 1/64
Gain	-6dB, -3dB, 0dB, 3dB, 6dB, 9dB, 12dB, 15dB, 18dB, 21dB, 24dB, Lolux (30dB, 36dB), AGC
Electronic shutter	1/4 to 1/10000, EEI
Variable Frame Rate	2/30-60/30fps, 2/25-50/25fps, 2/24-60/24fps
LCD monitor	3.5-inch LCD, 16:9, 920K pixels
Viewfinder	0.45-inch LCOS, 1.22M pixels (852 x 480 x 3)

Storage Section

Item	Description
Supported media	SDHC/SDXC
Slots	x 2

Video/Audio

Item	Description
Recording time	Approx. 25 minutes (8 GB SD card, 35 Mbps, VBR mode)
HD mode (MOV/MP4/MXF: MPEG-2) 660 (MOV/MP4: MPEG-2) 620	
Video recording file format	QuickTime File Format (For Final Cut Pro)/MP4 File Format/MXF File Format 660 QuickTime File Format (For Final Cut Pro)/MP4 File Format 620
Video	
HQ mode	MPEG-2 Long GOP VBR, 35 Mbps (Max) MP@HL, 1920x1080/59.94i, 29.97p, 23.98p, 50i, 25p 1440x1080/59.94i, 50i 1280x720/59.94p, 29.97p, 23.98p, 50p, 25p
SP mode	MPEG-2 Long GOP CBR, 18.3 Mbps MP@HL (720p)/25 Mbps MP@H14 (1080i) 1440x1080/59.94i, 50i 1280x720/59.94p, 50p
Audio	LPCM 2ch, 48 kHz/16 Bit
HD mode (AVCHD)	
Video recording file format	AVCHD File Format
Video	
HQ mode	MPEG-4 AVC/H.264, 28 Mbps (Max) 1920x1080/59.94p, 50p MPEG-4 AVC/H.264, 24 Mbps (Max) 1920x1080/59.94i, 50i
SP mode	MPEG-4 AVC/H.264, 18 Mbps (Max) 1920x1080/59.94i, 50i
LP mode	MPEG-4 AVC/H.264, 9 Mbps 1440x1080/59.94i, 50i
EP mode	MPEG-4 AVC/H.264, 5 Mbps 1440x1080/59.94i, 50i
Audio	Dolby Digital 2ch, 48 kHz/16 Bit, 256 kbps

Item	Description
HD mode (MOV: H.264)	
Video recording file format	QuickTime File Format
Video	
XHQ Mode	MPEG-4 AVC/H.264, 50 Mbps (Max) 1920x1080/59.94p, 59.94i, 29.97p, 23.98p, 50p, 50i, 25p
UHQ Mode	MPEG-4 AVC/H.264, 35 Mbps (Max) 1920x1080/59.94i, 29.97p, 23.98p, 50i, 25p
Audio	LPCM 2ch, 48 kHz/16 Bit
SD mode (MOV: H.264)	
Video recording file format	QuickTime File Format
Video	MPEG-4 AVC/H.264, 8 Mbps 720x480/59.94i (U model only), 720x576/50i (E model only)
Audio	LPCM 2ch, 48 kHz/16 Bit
Web mode (MOV: H.264) 660	
Video recording file format	QuickTime File Format
Video	
HQ mode	MPEG-4 AVC/H.264, 3 Mbps 960x540/29.97p, 23.98p, 25p
LP mode	MPEG-4 AVC/H.264, 1.2 Mbps 480x270/29.97p, 23.98p, 25p
Audio	μ-law 2ch, 16 kHz
Streaming mode 660	1920x1080/59.94i, 50i Audio AAC 128 k 12/8/5/3 Mbps 1280x720/29.97p, 25p Audio AAC 128 k 8/5/3/1.5 Mbps 720x480/59.94i 720x576/50i Audio AAC 128 k/64 k/32 k 8/5/3/1.5/0.8/0.3 Mbps 640x360/29.97p, 25p Audio AAC 32 k 3/1.5/0.8/0.3 Mbps

* The specifications and appearance of this product are subject to changes for further improvement without prior notice.

Software License Agreement

The software embedded in the Product (hereinafter the “Licensed Software”) provided by JVC KENWOOD Corporation (hereinafter the “Licensor”) is copyrighted to or sublicensable by the Licensor, and this Agreement provides for the terms and conditions which Users shall follow in order to use the Licensed Software. The User shall use the Licensed Software by agreeing with the terms of this Software License Agreement. This Agreement shall be deemed completed at the time the User (hereinafter the “User”) initially used the Product in which the “Licensed Software” is embedded.

The Licensed Software may include the software which has been licensed to the Licensor directly or indirectly from any third party. In such case, some third parties require the Users to follow their conditions for use separately from this Software License Agreement. Such software shall not be subject to this Agreement, and the Users are urged to read the “Important Notice concerning the Software” to be provided separately.

Article 1 General Provision

The Licensor shall grant to the User a non-exclusive and non-transferable (other than the exceptional case referred to in Article 3, Paragraph 1) licensed to use the Licensed Software within the country of the User (the country where the User bought the Product (hereinafter the “Country”).

Article 2 License

1. The license granted under this Agreement shall be the right to use the Licensed Software in the Product.
2. The User shall not duplicate, copy, modify, add, translate or otherwise alter, or lease the Licensed Software and any related documents, whether in whole or in part.
3. The use of the Licensed Software shall be limited to personal purpose, and the Licensed Software shall not be distributed, licensed or sub-licensed whether it is for commercial purpose or not.
4. The User shall use the Licensed Software according to the directions described in the operation manual or help file, and is prohibited to use or duplicate any data in a manner violating the Copyright Law or any other laws and regulations by applying whole or a part of the Licensed Software.

Article 3 Conditions for Grant of License

1. When the User transfers the Product, it may also transfer the license to use the Licensed Software embedded in the Product (including any related materials, updates and upgrades) on condition that no original, copies or related materials continue in the possession of the User, and that the User shall cause the transferee to comply with this Software License Agreement.
2. The User shall not carry out reverse engineering, disassembling, decompiling or any other code analysis works in connection with the Licensed Software.

Article 4 Right pertaining to the Licensed Software

1. Any and all copyrights and other rights pertaining to the Licensed Software and related documents shall belong to the Licensor or the original holder of the right who granted to the Licensor the license or sublicense for the Licensed Software (hereinafter the “Original Rightholder”), and the User shall not be entitled to any right other than the license granted hereunder, in respect of the Licensed Software and any related documents.
2. The User shall, whenever the User uses the Licensed Software, comply with any laws relating to the copyright and other intellectual property rights.

Article 5 Indemnification of Licensor

1. Neither the Licensor nor the Original Rightholder shall be liable for any damage incurred by the User or any third party due to the exercise of the license granted to the User under this Agreement, unless otherwise restricted by law.
2. The Licensor will offer no guarantee for the merchantability, convertibility and consistency with certain objective of the Licensed Software.

Article 6 Liability to Third Party

If any dispute has arisen with any third party due to an infringement upon a copyright, patent or any other intellectual property right that was caused by the User’s use of the Licensed Software, the User shall settle such dispute at the User’s own cost and hold the Licensor and the Original Rightholder harmless from any inconvenience it may cause.

Article 7 Confidentiality

The User shall keep the confidentiality of such portion of the Licensed Software, related documents thereof or any other information to be granted under this Agreement, as well as the conditions of this Agreement as has not yet entered the public domain, and shall not disclose or divulge the same to any third party without approval of the Licensor.

Article 8 Termination

In case the User falls under any of the events described in the following items, the Licensor may immediately terminate this Agreement or claim that the User compensates for the damage incurred by the Licensor due to such event:

- (1) when the User violated any provision of this Agreement; or
- (2) when a petition has been filed against the User for an attachment, provisional attachment, provisional disposition or any other compulsory execution.

Article 9 Destruction of the Licensed Software

If this Agreement is terminated pursuant to the provision of Article 8, the User shall destroy the Licensed Software, any related documents and copies thereof within two (2) weeks from such date of termination.

Article 10 Export Restriction

1. The User shall understand that the Licensed Software shall be subject to the export restrictions adopted by the country of User and any other countries.
2. The User shall agree that the software will be subject to any and all applicable international and domestic laws including the export control regulation of the country of User and any other countries, and any restrictions concerning the end-users, the use by end-users and importing countries to be provided by the country of User and any other countries, and any other governmental authorities.
3. If the User is an agency of the United States of America (the "Government"), the User acknowledge Licensor's representation that the Licensed Software is a "Commercial Item" as defined in Federal Acquisition Regulation (FAR) part 2.101(g) consisting unpublished "Commercial Computer Software" as those items are used at FAR part 12.212 and is only license the User with the same use right Licensor grants all commercial end users pursuant to the terms of this Agreement.

Article 11 Miscellaneous

1. In the event any part of this Agreement is invalidated by operation of law, the residual provisions shall continue in force.
2. Matters not stipulated in this Agreement or any ambiguity or question raised in the construction of this Agreement shall be provided or settled upon good-faith consultation between the Licensor and the User.
3. The Licensor and the User hereby agree that this Agreement is governed by the laws of Japan, and any dispute arising from, and relating to the rights and obligations under, this Agreement shall be submitted to the exclusive jurisdiction of the Tokyo District Court for its first instance.

Important Notice concerning the Software

Software License Attached to the Product :

The Software embedded in the Product is composed of several independent software components, and in each of such individual components (hereinafter the “Licensed Software”), a copyright of either JVC KENWOOD Corporation (hereinafter “JKC”) or a third party subsists. The Product uses the software component designated in the End-User License Agreement that was executed between JKC and a third party (hereinafter “EULA”).

The Licensed Software covers those corresponding to free software, and, as a condition of distribution of the software component in executable format which is based on the license granted under the GNU General Public License or Lesser General Public License (hereinafter “GPL/LGPL”), it requires an availability of the source code for the relevant component. Please refer to the following URL concerning the distribution of the source code;

<http://www3.jvckenwood.com/english/download/gpl/index.html>

Please note that we are unable to answer any inquiry relating to the contents, etc. of the source code. In addition, the Licensed Software includes the software developed or created independently by JKC and there exists an ownership of JKC in such software and any accompanying documents, which is protected by the Copyright Law, any international treaties and other applicable laws. As to matters concerning the handling by JKC of the software components, please refer to the “Software License Agreement” attached hereto. Please note that any software component licensed under “EULA” which is not subject to “GPL/LGPL”, and those developed or created independently by JKC shall not be subject to the requirement for provision of the source code. The software component distributed under “GPL/LGPL” shall be licensed to users without charge, and, therefore, no warranty is given for such software component, either express or implied, within the scope of the applicable laws and regulations. Unless otherwise permitted by applicable laws and regulations or agreed in written form, none of the owners of the copyright or persons entitled to alter or redistribute the software component under the said license shall have any liability for any type of damage or loss resulting from the use of or inability to use such software component. For further details of the conditions of use of such software component or matters required to be complied with, please refer to the relevant “GPL/LGPL”.

Users are urged to read the details for the relevant license carefully before using the software component covered by “GPL/LGPL” and embedded in the Product. Since the terms and conditions of individual licenses are provided by parties other than JKC, the original English version will be displayed by the Product.

- ① Turn on the power.
- ② Press the [MENU/THUMB] button.
- ③ Select [Main Menu] → [System] → [System Information] → [Open Source License].

GY-HM660U/GY-HM660E/GY-HM660RE/GY-HM620U/GY-HM620E
HD MEMORY CARD CAMERA RECORDER

JVC