

D-ILA PROJECTOR

DLA-Z1

D-ILA[®]
HDMI[™]
HIGH-DEFINITION MULTIMEDIA INTERFACE

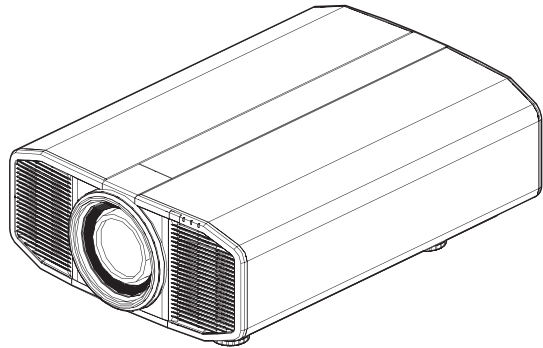

Mobile User Guide

● <http://manual3.jvckenwood.com/projector/mobile/global/>

The Mobile User Guide can be viewed on mobile internet devices including smartphones and tablets.



For Customer use :

Enter below the serial No. which is located on the side of the cabinet. Retain this information for future reference.

Model No. DLA-Z1 E

Serial No. _____

Pour utilisation par le client :

Entrerci-dessous le N° de série qui est situé sous le boîtier. Garder cette information comme référence pour le futur.

N° de modèle DLA-Z1 E

N° de série _____

Instrucción para el cliente :

Introduzca a continuación el n° de serie que aparece en la parte inferior lateral de la caja. Conserve esta información como referencia para uso ulterior.

Modelo N° DLA-Z1 E

N° de serie _____

Not suitable for household room illumination.

Safety Precautions

IMPORTANT INFORMATION

WARNING:

TO PREVENT FIRE OR SHOCK HAZARDS, DO NOT EXPOSE THIS APPLIANCE TO RAIN OR MOISTURE.

WARNING:

THIS APPARATUS MUST BE EARTHED.

CAUTION:

To reduce the risk of electric shock, do not remove cover. Refer servicing to qualified service personnel.

This projector is equipped with a 3-blade grounding type plug to satisfy FCC rule. If you are unable to insert the plug into the outlet, contact your electrician.

NOISE EMISSION DECLARATION

The sound pressure level at the operator position is equal or less than 50dB(A) according to ISO7779.

For the customers in Taiwan only

廢電池請回收

About the installation place

Do not install the projector in a place that cannot support its weight securely.

If the installation place is not sturdy enough, the projector could fall or overturn, possibly causing personal injury.

IMPORTANT SAFEGUARDS

Electrical energy can perform many useful functions. This unit has been engineered and manufactured to assure your personal safety. But **IMPROPER USE CAN RESULT IN POTENTIAL ELECTRICAL SHOCK OR FIRE HAZARD.** In order not to defeat the safeguards incorporated into this product, observe the following basic rules for its installation, use and service. Please read these Important Safeguards carefully before use.

- All the safety and operating instructions should be read before the product is operated.
 - The safety and operating instructions should be retained for future reference.
 - All warnings on the product and in the operating instructions should be adhered to.
 - All operating instructions should be followed.
 - Place the projector near a wall outlet where the plug can be easily unplugged.
 - Unplug this product from the wall outlet before cleaning.
 - Do not use liquid cleaners or aerosol cleaners. Use a damp cloth for cleaning.
 - Do not use attachments not recommended by the product manufacturer as they may be hazardous.
 - Do not use this product near water. Do not use immediately after moving from a low temperature to high temperature, as this causes condensation, which may result in fire, electric shock, or other hazards.
 - Do not place this product on an unstable cart, stand, or table. The product may fall, causing serious injury to a child or adult, and serious damage to the product. The product should be mounted according to the manufacturer's instructions, and should use a mount recommended by the manufacturer.
 - When the product is used on a cart, care should be taken to avoid quick stops, excessive force, and uneven surfaces which may cause the product and cart to overturn, damaging equipment or causing possible injury to the operator.
- PORTABLE CART WARNING
(symbol provided by RETAC)
- 
- S3126A
- Slots and openings in the cabinet are provided for ventilation. These ensure reliable operation of the product and protect it from overheating. These openings must not be blocked or covered. (The openings should never be blocked by placing the product on bed, sofa, rug, or similar surface. It should not be placed in a built-in installation such as a bookcase or rack unless proper ventilation is provided and the manufacturer's instructions have been adhered to.)
 - To allow better heat dissipation, keep a clearance between this unit and its surrounding as shown below. When this unit is enclosed in a space of dimensions as shown below, use an air-conditioner so that the internal and external temperatures are the same. Overheating can cause damage.

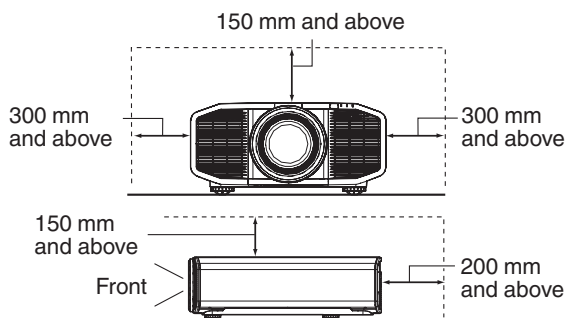

- Power source indicated on the label. If you are not sure of the type of power supply to your home, consult your product dealer or local power company.
- This product is equipped with a three-wire plug. This plug will fit only into a grounded power outlet. If you are unable to insert the plug into the outlet, contact your electrician to install the proper outlet. Do not defeat the safety purpose of the grounded plug.
- Power-supply cords should be routed so that they are not likely to be walked on or pinched by items placed upon or against them. Pay particular attention to cords at doors, plugs, receptacles, and the point where they exit from the product.
- For added protection of this product during a lightning storm, or when it is left unattended and unused for long periods of time, unplug it from the wall outlet and disconnect the cable system. This will prevent damage to the product due to lightning and power line surges.
- Do not overload wall outlets, extension cords, or convenience receptacles on other equipment as this can result in a risk of fire or electric shock.
- Never push objects of any kind into this product through openings as they may touch dangerous voltage points or short out parts that could result in a fire or electric shock. Never spill liquid of any kind on the product.
- Do not attempt to service this product yourself as opening or removing covers may expose you to dangerous voltages and other hazards. Refer all service to qualified service personnel.
- Unplug this product from the wall outlet and refer service to qualified service personnel under the following conditions:
 - a) When the power supply cord or plug is damaged.
 - b) If liquid has been spilled, or objects have fallen on the product.
 - c) If the product has been exposed to rain or water.
 - d) If the product does not operate normally by following the operating instructions. Adjust only those controls that are covered by the Operation Manual, as an improper adjustment of controls may result in damage and will often require extensive work by a qualified technician to restore the product to normal operation.
 - e) If the product has been dropped or damaged in any way.
 - f) When the product exhibits a distinct change in performance, this indicates a need for service.

- When replacement parts are required, be sure the service technician has used replacement parts specified by the manufacturer or with same characteristics as the original part. Unauthorized substitutions may result in fire, electric shock, or other hazards.
- Upon completion of any service or repairs to this product, ask the service technician to perform safety checks to determine that the product is in proper operating condition.
- The product should be placed more than one foot away from heat sources such as radiators, heat registers, stoves, and other products (including amplifiers) that produce heat.
- When connecting other products such as VCR's, and DVD players, you should turn off the power of this product for protection against electric shock.
- Do not place combustibles behind the cooling fan. For example, cloth, paper, matches, aerosol cans or gas lighters that present special hazards when over heated.
- Do not ceiling-mount the projector to a place which tends to vibrate; otherwise, the attaching fixture of the projector could be broken by the vibration, possibly causing it to fall or overturn, which could lead to personal injury.
- Use only the accessory cord designed for this product to prevent shock.
- For health reasons, please take a break of about 5-15 minutes every 30-60 minutes and let your eyes rest. Please refrain from watching any 3D-images when you feel tired, unwell or if you feel any other discomfort. Moreover, in case you see a double image, please adjust the equipment and software for proper display. Please stop using the unit if the double image is still visible after adjustment.
- Once every three years, please perform an internal test. This unit is provided with replacement parts needed to maintain its function (such as cooling fans). Estimated replacement time of parts can vary greatly depending on frequency of use and the respective environment. For replacement, please consult your dealer, or the nearest authorized JVC service center.
- When fixing the unit to the ceiling, Please note that we do not take any responsibility, even during the warranty period, if the product is damaged due to use of metal fixtures used for fixation to the ceiling other than our own or if the installation environment of said metal fixtures is not appropriate. If the unit is suspended from the ceiling during use, please be careful in regard to the ambient temperature of the unit. If you use a central heating, the temperature close to the ceiling will be higher than normally expected.
- Video images can burn into the electronic component parts. Please do not display screens with still images of high brightness or high contrast, such as found in video games and computer programs. Over a long period of time it might stick to the picture element. There is no problem with the playback of moving images, e.g. normal video footage.
- Not using the unit for a long time can lead to malfunction. Please power it on and let it run occasionally. Please avoid using the unit in a room where cigarettes are smoked. It is impossible to clean optical component parts if they are contaminated by nicotine or tar. This might lead to performance degradation.
- Please watch from a distance three times the height of the projected image size. Persons with photosensitivity, any kind of heart disease, or weak health should not use 3D glasses.
- Watching 3D-images might be cause of illness. If you feel any change in your physical condition, please stop watching immediately and consult a physician if necessary.
- When watching 3D images, it is recommended to take regular breaks. As the length and frequency of the required breaks differ for every person, please judge according to your own condition.
- If your child watches while wearing 3D glasses, it should be accompanied by its parents or an adult guardian. The adult guardian should be careful to avoid situations where the child's eyes might become tired, as responses to tiredness and discomfort, etc., are hard to detect, and it is possible for the physical condition to deteriorate very quickly. As the visual sense is not yet fully developed in children under the age of 6, please consult a physician in regard to any problem concerning 3D-images if necessary.
- Note that when using the 3D feature, the video output may appear different from the original video image due to image conversion on the device.

*** DO NOT allow any unqualified person to install the unit.**

Be sure to ask your dealer to install the unit (e.g. attaching it to the ceiling) since special technical knowledge and skills are required for installation. If installation is performed by an unqualified person, it may cause personal injury or electrical shock.

- Do not use optical instruments (such as magnifying glass or reflector) viewing the laser output. It may pose an eye hazard.
- When turning on the projector, ensure that no one is looking into the projection lens.
- Do not look into the lens and openings when the light is on. Doing so would have serious effects on the human body.
- Do not detach or attach the projection lens with the power connected.
- Attempting to disassemble, repair or modify the projector yourself may lead to serious safety issues.
- Using a faulty product not only results in electrical shock or fire hazard, it can cause visual impairment.
- When abnormality occur, stop using the projector immediately and send it to your authorized dealer for repair.

POWER CONNECTION

For USA and Canada only
Use only the following power cord.

Power cord



The power supply voltage rating of this product is AC100V – AC240V. Use only the power cord designated by our dealer to ensure Safety and EMC. Ensure that the power cable used for the projector is the correct type for the AC outlet in your country. Consult your product dealer.

Power cord

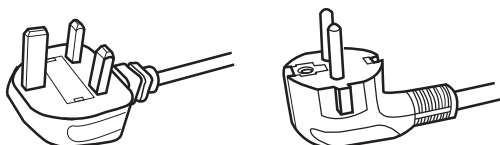

For United Kingdom

For European continent
countries

WARNING:

Do not cut off the main plug from this equipment.

If the plug fitted is not suitable for the power points in your home or the cable is too short to reach a power point, then obtain an appropriate safety approved extension lead or adapter or consult your dealer. If nonetheless the mains plug is cut off, dispose of the plug immediately, to avoid a possible shock hazard by inadvertent connection to the main supply.

WARNING:

THIS APPARATUS MUST BE EARTHED.

Dear Customer,

This apparatus is in conformance with the valid European directives and standards regarding electromagnetic compatibility and electrical safety.

European representative of
JVC KENWOOD Corporation is:
JVCKENWOOD Deutschland GmbH
Konrad-Adenauer-Allee 1-11,
61118 Bad Vilbel,
GERMANY

IMPORTANT (Europe only):

The wires in the mains lead on this product are colored Vert et jaune in accordance with the following cord:

Green-and-yellow : Earth
Blue : Neutral
Brown : Live

As these colors may not correspond with the colored making identifying the terminals in your plug, proceed as follows:

The wire which is colored green-and-yellow must be connected to the terminal which is marked M with the letter E or the safety earth or colored green or green-and-yellow. The wire which is colored blue must be connected to the terminal which is marked with the letter N or colored black.

The wire which is colored brown must be connected to the terminal which is marked with the letter L or colored red.

POWER CONNECTION (United Kingdom only)

HOW TO REPLACE THE FUSE:

When replacing the fuse, be sure to use only a correctly rated approved type, re-fit the fuse cover.

IF IN DOUBT — CONSULT A COMPETENT ELECTRICIAN.

Open the fuse compartment with the blade screwdriver, and replace the fuse.

(* An example is shown in the illustration below.)

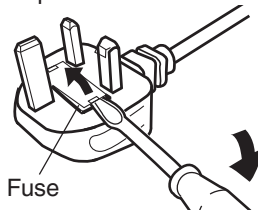

Information for Users on Disposal of Old Equipment and Batteries



Products



Battery

[European Union only]

These symbols indicate that equipment with these symbols should not be disposed of as general household waste. If you want to dispose of the product or battery, please consider the collection systems or facilities for appropriate recycling.

Notice: The sign Pb below the symbol for batteries indicates that this battery contains lead.

Informations relatives à l'élimination des appareils et des piles usagés, à l'intention des utilisateurs



Produits



Pile

[Union européenne seulement]

Si ces symboles figurent sur les produits, cela signifie qu'ils ne doivent pas être jetés comme déchets ménagers. Si vous voulez jeter ce produit ou cette pile, veuillez considérer le système de collecte des déchets ou les centres de recyclage appropriés.

Notification: La symbole Pb en dessous du symbole des piles indique que cette pile contient du plomb.

Información para los usuarios sobre la eliminación de baterías/pilas usadas



Productos



Baterías/pilas

[Sólo Unión Europea]

Estos símbolos indican que el equipo con estos símbolos no debe desecharse con la basura doméstica. Si desea desechar el producto o batería/pila, acuda a los sistemas o centros de recogida para que los reciclen debidamente.

Atención: La indicación Pb debajo del símbolo de batería/pila indica que ésta contiene plomo.

Benutzerinformationen zur Entsorgung alter Geräte und Batterien



Produkte



Batterie

[Nur Europäische Union]

Diese Symbole zeigen an, dass derartig gekennzeichnete Geräte nicht als normaler Haushaltsabfall entsorgt werden dürfen. Wenden Sie sich zur Entsorgung des Produkts oder der Batterie an die hierfür vorgesehenen Sammelstellen oder Einrichtungen, damit eine fachgerechte Wiederverwertung möglich ist.

Hinweis: Das Zeichen Pb unterhalb des Batteriesymbols gibt an, dass diese Batterie Blei enthält.

Informazioni per gli utenti sullo smaltimento delle apparecchiature e batterie obsolete



Prodotti



Batteria

[Solo per l'Unione Europea]

Questi simboli indicano che le apparecchiature a cui sono relativi non devono essere smaltite tra i rifiuti domestici generici. Se si desidera smaltire questo prodotto o questa batteria, prendere in considerazione i sistemi o le strutture di raccolta appropriati per il riciclaggio corretto.

Nota: Il simbolo Pb sotto il simbolo delle batterie indica che questa batteria contiene piombo.

Informatie voor gebruikers over het verwijderen van oude apparatuur en batterijen



Producten



Batterij

[Alleen Europese Unie]

Deze symbolen geven aan dat apparatuur met dit symbool niet mag worden weggegooid als algemeen huishoudelijk afval. Als u het product of de batterij wilt weggooien, kunt u inzamelsystemen of faciliteiten voor een geschikte recycling gebruiken.

Opmerking: Het teken Pb onder het batterijsymbool geeft aan dat deze batterij lood bevat.

For the customers In the U.S.A. and Canada

CAUTION

Use of controls or adjustments or performance of procedures other than those specified herein may result in hazardous radiation exposure.
 This Projector is classified as a CLASS 3R LASER PRODUCT.
 This CLASS 3R LASER PRODUCT label and Caution label is located on the Rear Side surface of the projector.



Location information of the labels

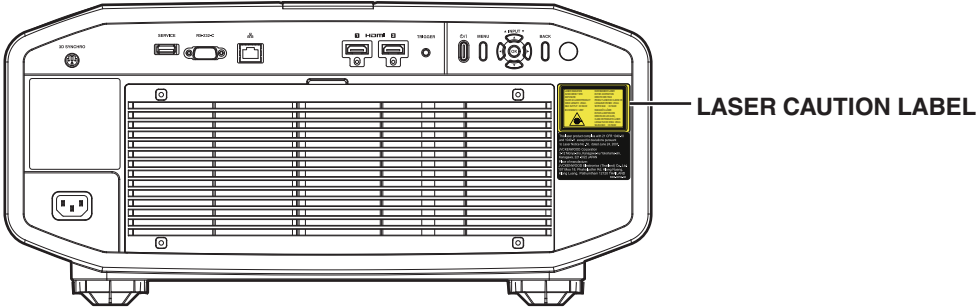

APERTURE LABEL



The APERTURE LABEL is located on the top cover.

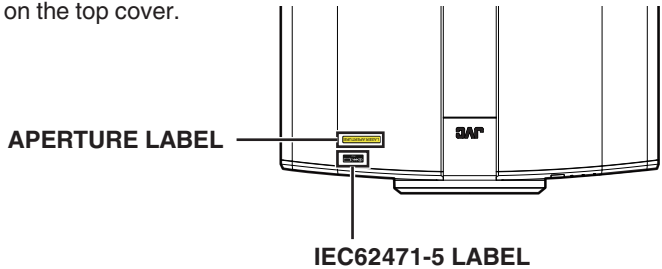

WARNING

LASER RADIATION AVOID DIRECT EYE EXPOSURE CLASS 3R LASER PRODUCT.

CAUTION

- Do not look into the lens while in use.
- Light source specifications
- 30 W Laser diodes x6
- Wavelength 450 - 460 nm
- Maximum output is 64.12 W

Beam divergence angle from lens of this unit

Wide : $\alpha=71^\circ$
 Tele : $\alpha=39^\circ$

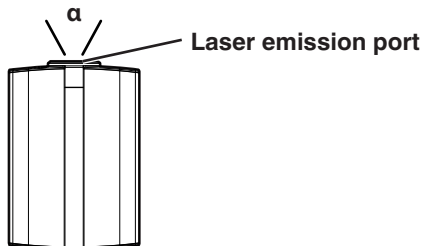

For the customers In other countries

CLASS 1 LASER PRODUCT

LASER CAUTION LABEL



WARNING

Do not look into the lens while in use.

CAUTION

Use of controls or adjustments or performance of procedures other than those specified herein may result in hazardous radiation exposure.

Location information of the labels

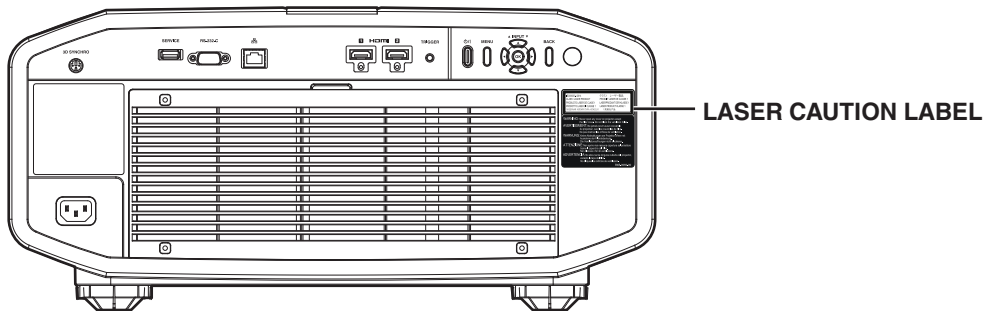

IEC62471-5

Location information of the labels

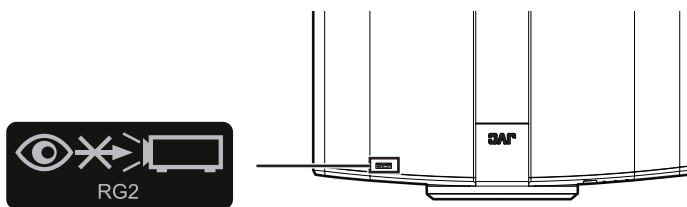

As with any bright light source, do not stare into the beam, RG2 IEC 62471-5:2015

Contents

Getting Started

| | |
|---|----|
| Safety Precautions | 2 |
| Accessories/Optional Accessories | 10 |
| Check the Accessories | 10 |
| Optional Accessories | 10 |
| Controls and Features | 11 |
| Main Unit - Front | 11 |
| Main Unit - Bottom | 11 |
| Main Unit - Rear | 12 |
| Main Unit - Input Terminals | 13 |
| Remote Control | 14 |
| Loading Batteries into the Remote Control | 15 |
| Effective Range of Remote Control Unit | 15 |
| Menu | 16 |

Set up







| | |
|---|----|
| Installing the Projector | 17 |
| Precautions during Installation | 17 |
| Precautions during Mounting | 18 |
| Adjusting the Position | 20 |
| Connecting the Projector | 21 |
| Connecting to the HDMI Input Terminal (Digital Input) | 21 |
| Connecting to the LAN Terminal | 22 |
| Connecting to the RS-232C Terminal | 22 |
| Connecting to the TRIGGER Terminal | 23 |
| Connecting the Power Cord (Supplied Accessory) | 23 |

Operate

| | |
|---|----|
| Viewing Videos | 24 |
| Adjusting the Projector Screen | 26 |
| Adjusting the Lens According to the Projection Position | 26 |
| Setting Screen Correction | 27 |
| Adjusting the Screen Size (Aspect) | 28 |
| Viewing 3D Movies | 29 |
| Installing the 3D Synchro Emitter | 29 |
| Viewing 3D Movies | 30 |
| Adjusting 3D Movies | 30 |

Adjust/Set

| | |
|--|----|
| Selecting an Image Quality According to the Video Type | 31 |
| Setting the Picture Mode | 31 |
| Setting the Color Profile | 32 |
| Adjusting to your Preferred Color (Color Management) | 34 |
| Adjusting Movies for Increased Detail and Sharpness (Multiple Pixel Control) | 35 |

| | |
|--|----|
| Fine-tuning the Image Quality | 36 |
| Adjusting the Output Value of the Projected Image (Gamma) | 36 |
| Fine-tuning to the Preferred Gamma Setting | 38 |
| Reducing the After-image of Fast-moving Images (Blur Reduction) | 40 |
| Adjustments and Settings in the Menu | 42 |
| List of Menu Items | 42 |
|  Picture Adjust | 44 |
|  Input Signal | 49 |
|  Installation | 50 |
|  Display Setup | 57 |
|  Function | 58 |
|  Information | 60 |

Maintenance

| | |
|--|----|
| Maintaining the Cabinet and Remote Control | 61 |
| Cleaning and Replacing the Filter | 61 |

Troubleshooting

| | |
|--|----|
| Troubleshooting | 62 |
| When the Following Messages Appear... .. | 66 |

Others

| | |
|------------------------------|----|
| External Control | 67 |
| RS-232C Specifications | 67 |
| TCP/IP Connection | 67 |
| Command Format | 68 |
| Remote Control Code | 69 |
| Communications Example | 70 |
| Specifications | 71 |
| Index | 78 |

Accessories/Optional Accessories

Check the Accessories

Lens cover 1 piece

Remote control 1 piece

AAA-size batteries (for operational check) 2 pieces

Power cord (for UK) (about 2 m) 1 piece

Power cord (for EU) (about 2 m) 1 piece

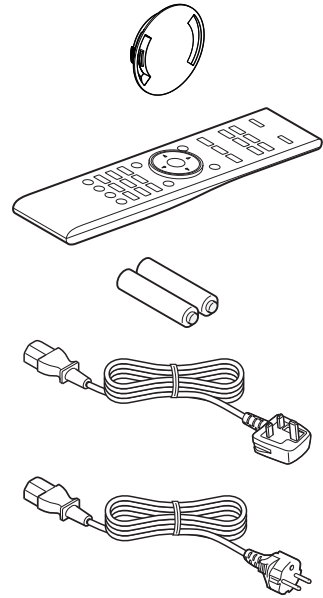

- Quick User Guide, safety precautions, warranty card, and other printed material are also included.
- Be sure to read the “Safety Precautions” before using this projector.

Optional Accessories

- 3D Glasses: model PK-AG3
- 3D Synchro Emitter: model PK-EM2

Compatibility Chart for 3D Synchro Emitter and 3D Glasses

| | | 3D Glasses | | |
|--------------------|--|---|---|--|
| | | PK-AG1 * (Communication Method: IR (Infrared)) | PK-AG2 * (Communication Method: IR (Infrared)) | PK-AG3 (Communication Method: RF (Radio frequency)) |
| 3D Synchro Emitter | PK-EM1 * (Communication Method: IR (Infrared)) | ○ | ○ | — |
| | PK-EM2 (Communication Method: RF (Radio frequency)) | — | — | ○ |

* Discontinued product

Please check with your authorized dealer for details.

Controls and Features

Main Unit - Front

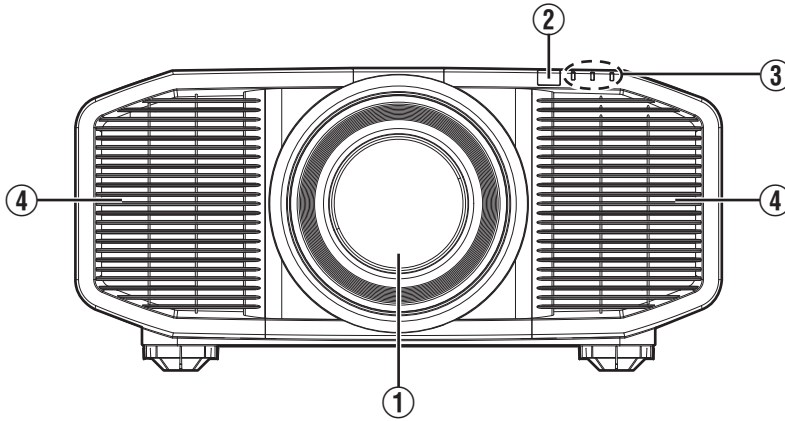

① Lens

This is a projection lens. Do not look through the lens while an image is projected.

② Remote Sensor (front)

Please aim the remote control at this area when using it.

* There is also a remote sensor at the rear.

③ Indicator

Refer to “Indicator Display on the Main Unit” P. 75.

④ Exhaust vent

Warm air is discharged to cool down the internal temperature.
Do not block the vents.

Main Unit - Bottom

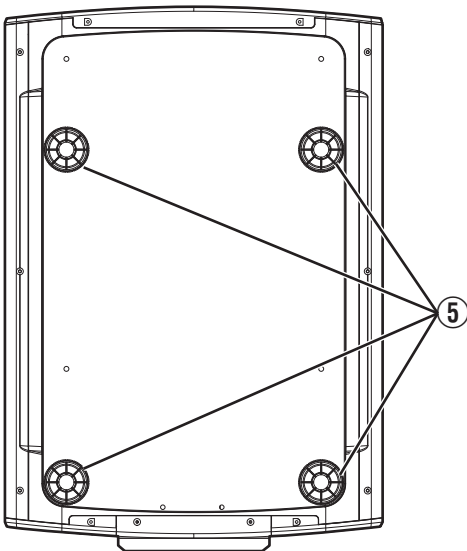

⑤ Feet

The height and angle of the projector can be adjusted by turning the foot. (0 to 5 mm) (P. 20)

When the foot is removed, it can be used as the mounting hole for the ceiling mount bracket.

Main Unit - Rear

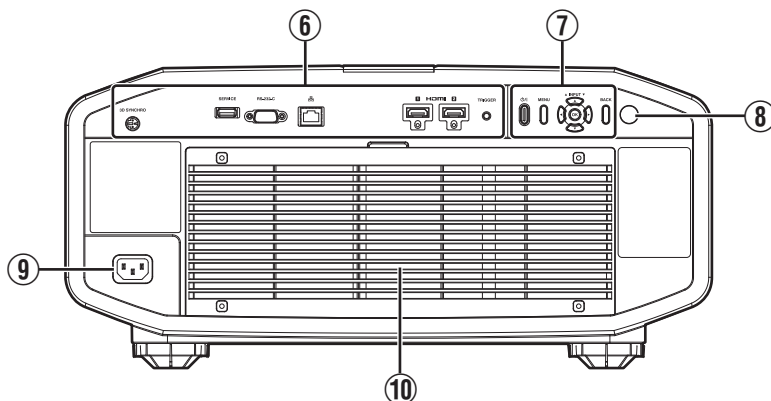

⑥ Input terminals

In addition to the video input terminal, there are also other connection terminals for devices such as controllers and optional equipment.

Please see “Main Unit - Input Terminals” P. 13 for more details about the terminals.

⑦ Operation panel

For more details, please refer to the “Operation panel” in the diagram below.

⑧ Remote Sensor (rear)

Please aim the remote control at this area when using it.

* There is also a remote sensor at the front.

⑨ Power input terminal

Connect the supplied power cord to this terminal.

⑩ Air Inlets

The inlets take in air to cool down the internal temperature.

Do not block the inlet. Do not blow hot air on the inlet. Doing so may cause the unit to malfunction.

Operation panel

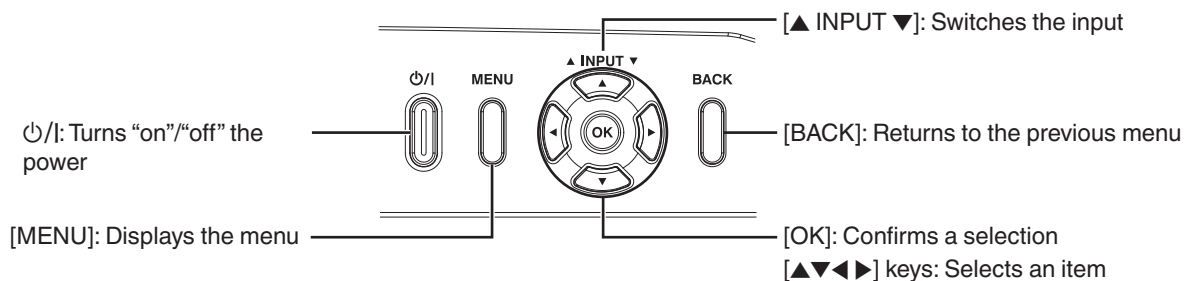

Main Unit - Input Terminals

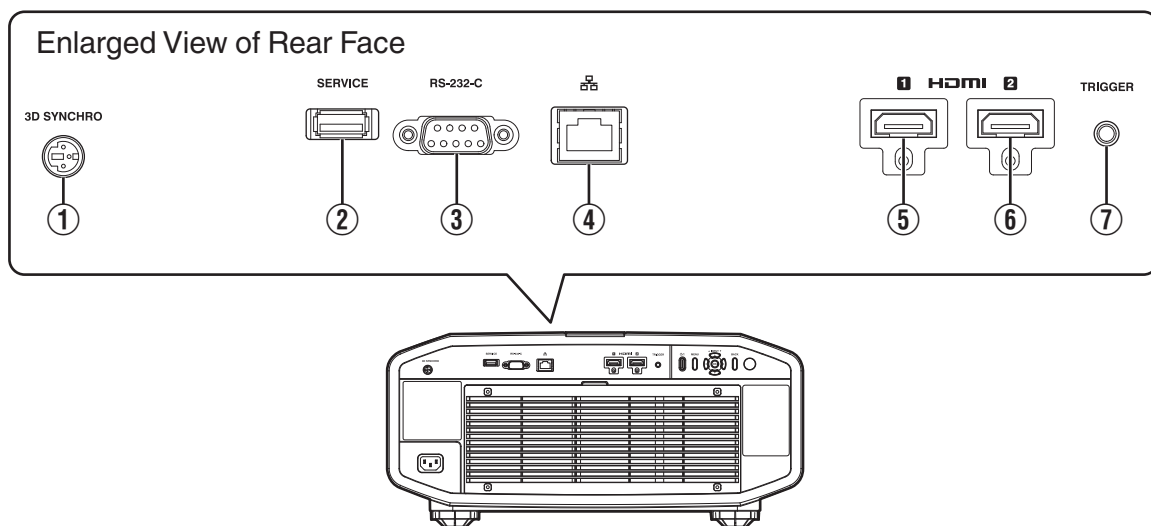

① [3D SYNCHRO] terminal

By connecting a 3D Synchro Emitter (sold separately) to this terminal, you can view 3D movies.

② [SERVICE] terminal

For updating the software using a commercially available USB flash drive.

③ [RS-232C] terminal (D-sub 9-pin male)

The projector can be controlled by connecting a PC to this terminal.

④ [LAN] terminal (RJ-45)

The projector can be controlled by connecting it to a PC through the computer network for control commands to be sent to the projector.

⑤ [HDMI 1] input terminal

⑥ [HDMI 2] input terminal

For connecting to devices that support HDMI output. (P. 21)

It is fitted to the M3 lock hole. The depth of the screw hole is 3 mm.

⑦ [TRIGGER] terminal

Output terminal for DC 12 V, 100 mA power supply. It is used for sending output signals to control devices such as an elevating screen that is equipped with a trigger function.

Note that improper connection may damage the projector. (Tip=DC +12 V, Sleeve=GND)

Remote Control

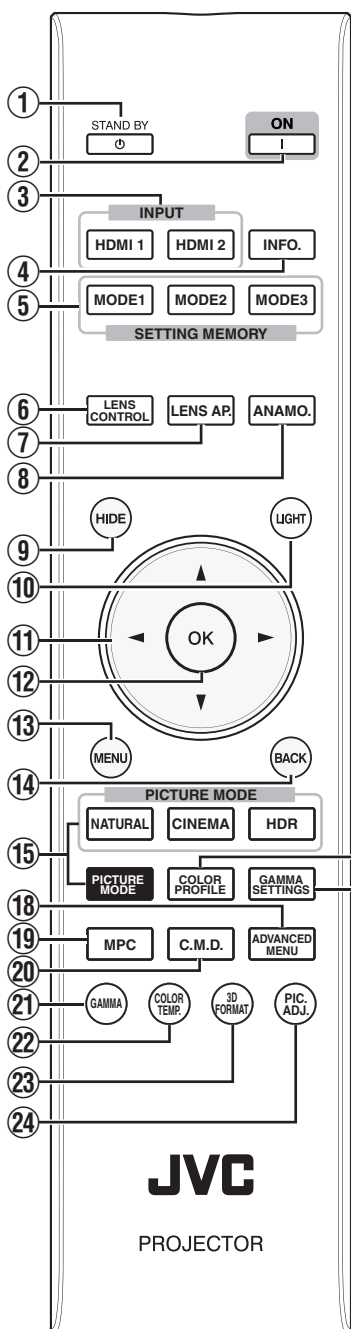

① [STANDBY]

Turns off the power. (P. 25)

② [ON]

Turns on the power. (P. 24)

③ [INPUT]

Switches the input to [HDMI 1] or [HDMI 2]. (P. 24)

④ [INFO.]

Displays the information menu. (P. 60)

⑤ [SETTING MEMORY]

Retrieves Mode 1, Mode 2 or Mode 3 setting of Installation Mode.

⑥ [LENS CONTROL]

For adjusting focus, zoom, and shift. (P. 26)

- Pressing the button each time switches the setting in the following sequence: "Focus" → "Zoom" → "Shift"...

⑦ [LENS AP.]

For setting the aperture. (P. 44)

⑧ [ANAMO.]

Switches the anamorphic mode.

- Pressing the button each time switches the setting in the following sequence: "Off" → "A" → "B"...

⑨ [HIDE]

Hides the image temporarily. (P. 24)

⑩ [LIGHT]

Illuminates the buttons on the remote control.

⑪ [▲▼◀▶] keys

For selecting an item.

⑫ [OK]

Confirms a selected item.

⑬ [MENU]

Displays the menu, or hides the menu if it is displayed.

⑭ [BACK]

Returns to the previous menu.

⑮ [PICTURE MODE]

Switches the picture mode. (P. 31)

- Press [NATURAL], [CINEMA] or [HDR] to switch to the respective picture mode.
- Pressing [PICTURE MODE] displays the Picture mode selection menu.

⑯ [COLOR PROFILE]

For setting the color profile. (P. 32)

- Pressing the button each time switches the configurable color profile in sequence.

⑰ [GAMMA SETTINGS]

Displays the gamma setting menu.

⑱ [ADVANCED MENU]

Pressing the button each time switches the menu in the following sequence: "Picture Mode" → "Color Profile" → "Color Temp." → "Blur Reduction"

⑲ [MPC]

Displays the MPC setting menu. (P. 35)

⑳ [C.M.D.]

For setting frame interpolation. (P. 40)

- Pressing the button each time switches the setting in the following sequence: "Low" → "High" → "Inverse Telecine" → "Off"...

㉑ [GAMMA]

Switches the gamut. (P. 36)

- Pressing the button each time switches the configurable gamma in sequence.

㉒ [COLOR TEMP.]

Switches the color temperature. (P. 45)

- Pressing the button each time switches the configurable color temperature in sequence.

㉓ [3D FORMAT]

For setting the 3D format. (P. 30)

- Pressing the button each time switches the setting in the following sequence: "Auto" → "Side by Side" → "Top and Bottom" → "2D"...

㉔ [PIC. ADJ.]

Displays the picture quality adjustment gauge. (P. 48)

- Pressing the button each time displays the adjustment gauge in the following sequence: "Contrast" → "Brightness" → "Color" → "Tint" → "Aperture" → "Picture Tone" → "Dark Level" → "Bright Level".

Loading Batteries into the Remote Control

Loading the batteries

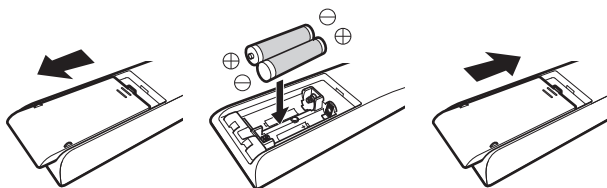

Removing the batteries

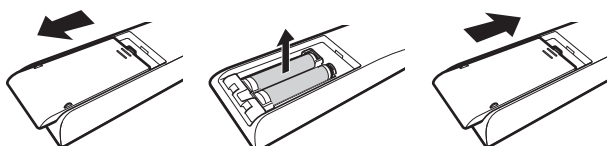

- If the remote control has to be brought closer to the unit to operate, it means that the batteries are wearing out. Replace the batteries with new ones (AAA).
- Insert the batteries according to the \oplus \ominus marks. Be sure to insert the \ominus end first. When removing the battery, do so from the \oplus end.
- If an error occurs while using the remote control, remove the batteries and wait for five minutes. Load the batteries again and operate the remote control.

CAUTION

- Do not put the remote control in a place with an exposure to direct sun light or high temperature. It may be deformed due to heat, or the internal components may be adversely affected resulting in fire hazard.
- Remove the batteries from the remote control when storing the remote control. Storing the remote control for a prolonged period without removing the batteries can cause battery leakage.

Effective Range of Remote Control Unit

When aiming the remote control toward the sensor on this unit (front or rear), ensure that the distance to the sensor is within 7 m.

If the remote control fails to work properly, move closer to this unit.

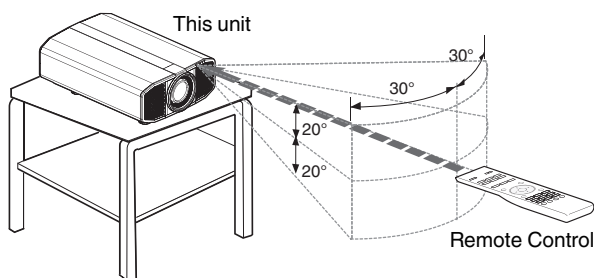

Control through reflection off a screen, etc.

Ensure that the total of distance A (between this unit and the screen) and distance B (between the remote control and the screen) is within 7 m.

- * As the efficiency of signals reflected from the remote control unit varies with the type of screen used, the operable distance may decrease.

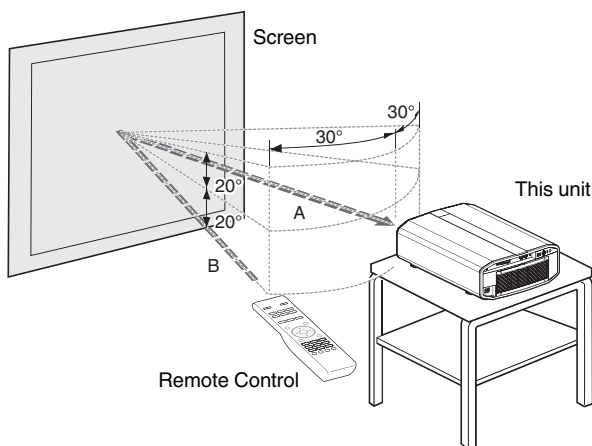

CAUTION

- Do not put the remote control in a place with an exposure to direct sun light or high temperature. It may be deformed due to heat, or the internal components may be adversely affected resulting in fire hazard.
- Remove the batteries from the remote control when storing the remote control. Storing the remote control for a prolonged period without removing the batteries can cause battery leakage.

Menu

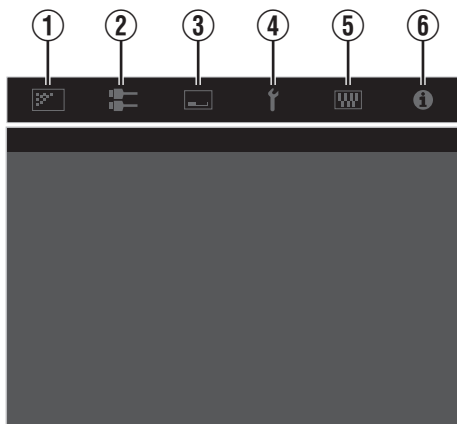

Select the icon at the top of the menu to display its corresponding setting item as shown below.

① Picture Adjust



② Input Signal



③ Installation



④ Display Setup



⑤ Function



⑥ Information



Installing the Projector

Precautions during Installation

Please read the following carefully before installing this unit.

When carrying this unit

This unit is heavy in weight. Please ensure that there are at least two persons carrying it.

Do not install at the following

This unit is a precision device. Please refrain from installing or using it at the following locations. Otherwise, it may cause fire or malfunction.

- Dusty, wet and humid places
- Places subject to oily smoke or cigarette smoke
- On top of a carpet or bedding, or other soft surfaces
- Places exposed to direct sunlight
- Places with a high or low temperature
- Do not install this unit in a room that is oily or subject to cigarette smoke. Even a small quantity of smoke or oiliness can have a long-term impact on this unit.
- * This unit produces a great amount of heat, and is designed to take in cool air to cool its optical components. Using the unit at the above locations may cause dirt to attach to the light path, thereby resulting in dark images or dull colors.
- * Dirt that sticks to the optical components cannot be removed.

Maintain clearance from the wall, etc.

As the unit discharges a large amount of heat, install it with adequate clearance from the surroundings as shown below.

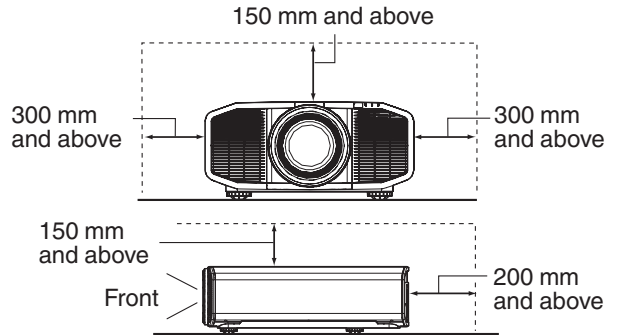

Leave the front area of the unit unblocked. If there is any obstructing object in front of the exhaust vent, hot air will flow back to the unit and cause it to heat up. Hot air flowing out of the unit may cast shadows on the screen (heat haze phenomenon).

Installing the screen

Install the unit and the screen such that they are perpendicular to each other.

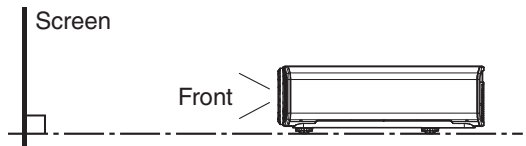

- Please choose a screen material with non-uniform patterns. Uniform patterns such as checks may cause interference patterns to occur.
- In this case, you can change the size of the screen to make the interference patterns less noticeable.

Using the projector at a high altitude

When using this unit at a location that is higher than 900 m above sea level (low air pressure), set the "High Altitude Mode" to "On". (P. 57)

Precautions during Mounting

Securing (mounting) the projector

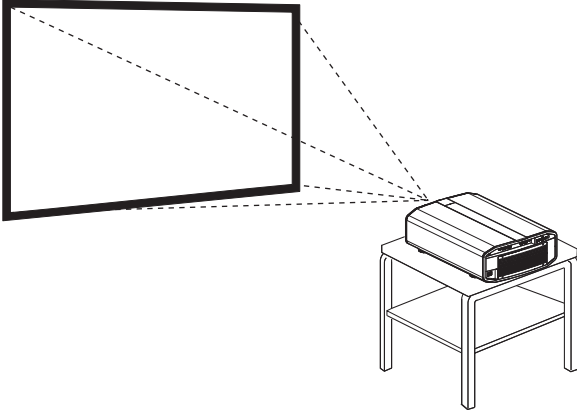

- When this unit is to be mounted to a fixed position for use, install it horizontally.
- Make sure to secure the main unit to prevent accidents such as during an earthquake.

Securing with screws

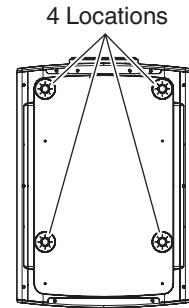

Remove the four feet at the bottom, and fasten using the screws (M5 screws, 15 to 25 mm).

- * Using screws other than those designated may cause the unit to break down.

Securing the projector (ceiling mount)

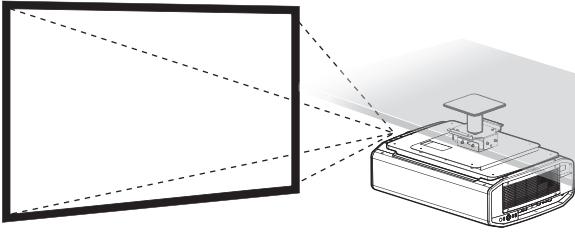

- Be sure to ask your dealer to install the unit for you. Installing the unit on your own may cause the unit to fall resulting in injury.
- Take the necessary actions to prevent the main unit from falling off such as during an earthquake.
- Regardless of the warranty period, JVC is not liable for any product damage caused by mounting the unit with non-JVC ceiling fittings or to an environment that is not suited for ceiling mount.
- When using the unit with it suspended from a ceiling, pay attention to the surrounding temperature. When a heater is in use, the temperature around the ceiling may be higher than expected.
- To attach the unit to the ceiling mount bracket, set the torque between the range of 1.5N m to 2.0N m. Tightening with torque exceeding the above range may cause damage to the unit, which may result the unit to fall.
- When reusing the ceiling mount bracket of an old model, consult the specialist to check if there are any issues with the surrounding space and increase in weight.
- Install the outlet at an accessible height to unplug from the wall. Or install the circuit breaker at an accessible height to shut down the projector. If you need information, please consult your authorized dealer or specialist.

Installing the ceiling mounting bracket

- ① Remove the rear foot (x2).

- The removed feet can be installed to the rear holes. (*1)
- It is not necessary to remove the front feet. However, it will not pose any usage problems even when they are removed.

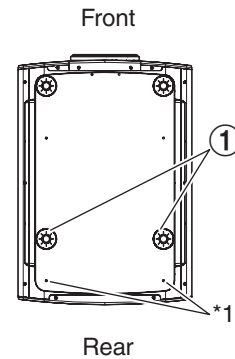

- ② Install the ceiling mounting brackets to the screw holes indicated by the arrows.

- Use screws that meet the specification.
- For details, contact your authorized dealer.

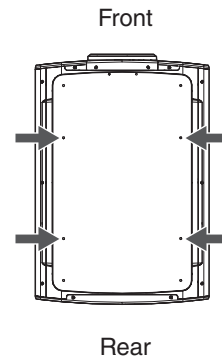

Adjusting the Position

Adjusting the elevation angle of the projector

The height and inclination of the unit (0 to 5 mm) can be adjusted by turning the feet.

Lift the unit and adjust the four feet.

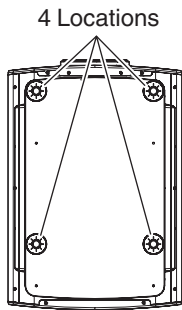
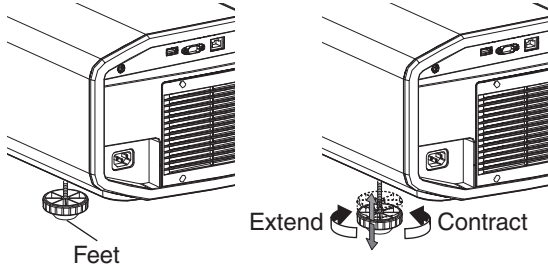

Adjusting the position of the image

By using the lens shift feature of this unit, you can shift the image upward/downward or to the left/right. Set it to your preferred position.

➔ “Adjusting the Lens According to the Projection Position” (P. 26)

Horizontal Position

Vertical Position: 0% (Center)

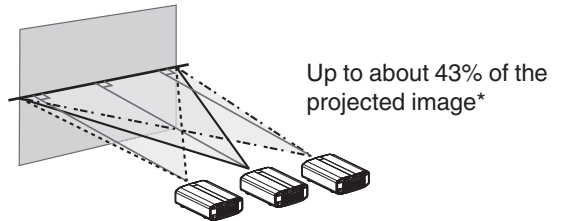

Vertical Position

Horizontal Position: 0% (Center)

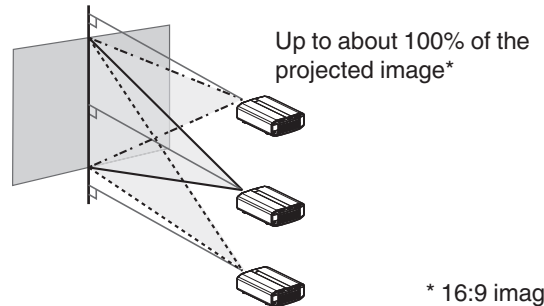

* 16:9 image

Lens shift Range

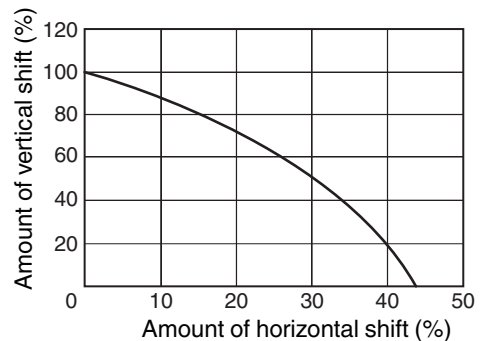

- The maximum vertical shift varies with the amount of horizontal shift. Similarly, the maximum horizontal shift also changes with the amount of vertical shift.
- The values on the graph are intended as a guide. Use them for reference during installation.

Connecting the Projector

- Do not turn on the power until connection is complete.
- The connection procedures differ according to the device used. For details, please refer to the instruction manual of the device to be connected.
- This projector is used for projecting images. To output the audio of connected devices, please connect a separate audio output device, such as an amplifier or speaker.
- The images may not be displayed depending on the devices and cables to be connected.
Use a high-speed HDMI cable (sold separately) that is HDMI-certified.
Please use a certified Premium High Speed HDMI Cable (18 Gbps compatible) when inputting 4K video signals from an external device.
- Also, please refer to “HDMI 2 EDID”P. 49.
- Some cables cannot be connected to this unit due to the size of their connector cover.

Connecting to the HDMI Input Terminal (Digital Input)

Connecting via HDMI cable

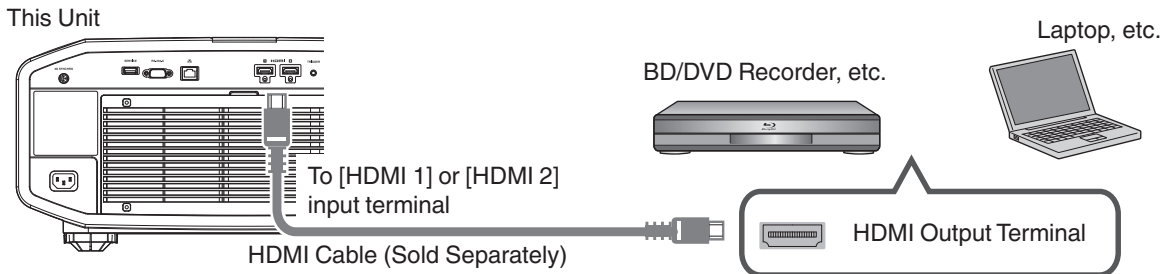

- If noise occurs, move the laptop away from this unit.

Connecting through an AV amplifier

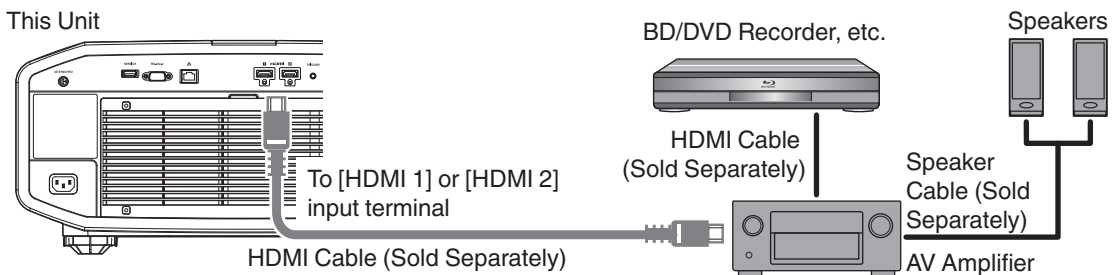

- If the source device is connected to the projector through an intermediate device such as an AV amplifier or divider, the video image may not appear depending on the specifications of the intermediate device.
In this case, connect the source device directly to the projector, and check whether the video image is displayed.

Connecting via HDMI-DVI conversion cable

This Unit

Desktop PC, etc.

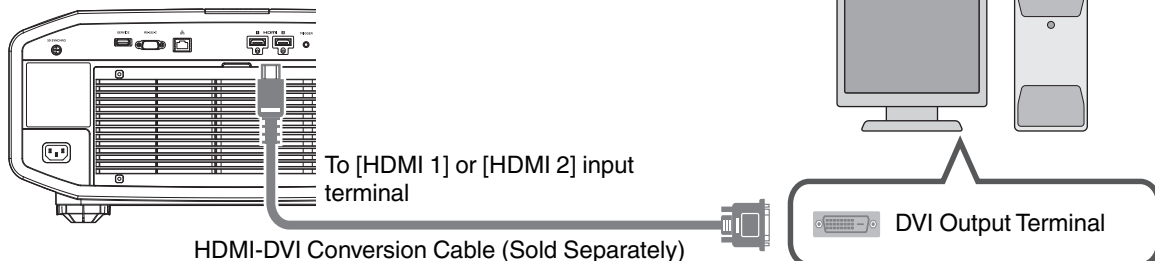

- If noise occurs, move the desktop PC away from this unit.
- If the video is not displayed, try to reduce the length of the cable or lower the resolution of the video transmitting equipment.

Connecting to the LAN Terminal

This Unit

Desktop PC, etc.

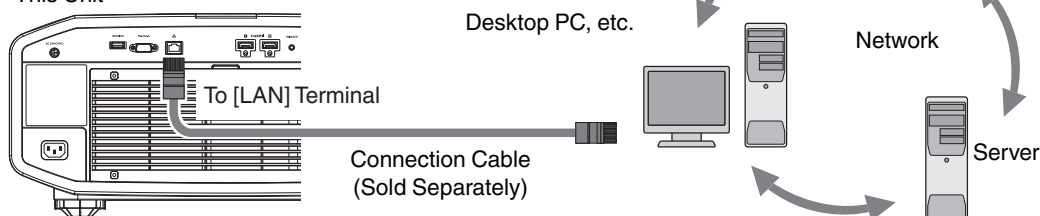

- The network is used to control this unit. It is not used for sending or receiving video signals.
- Please contact your network administrator for information concerning the network connection.
- Set "ECO Mode" to "Off" if LAN communication is performed in the Standby mode. (P. 58)
- For more information on control, please refer to "External Control" P. 67.

Connecting to the RS-232C Terminal

This Unit

Laptop, etc.

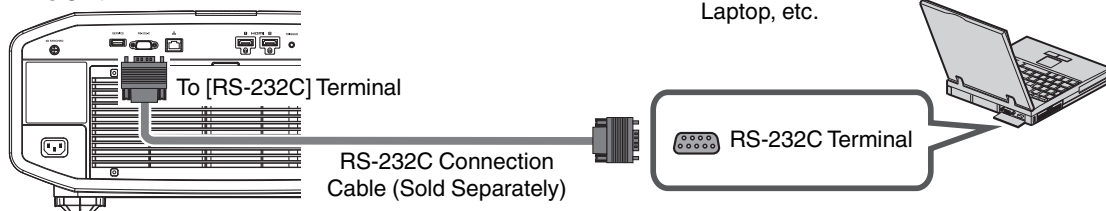

- Set "ECO Mode" to "Off" if RS-232C communication is performed in the Standby mode. (P. 58)
- For more information on control, please refer to "External Control" P. 67.

Connecting to the TRIGGER Terminal

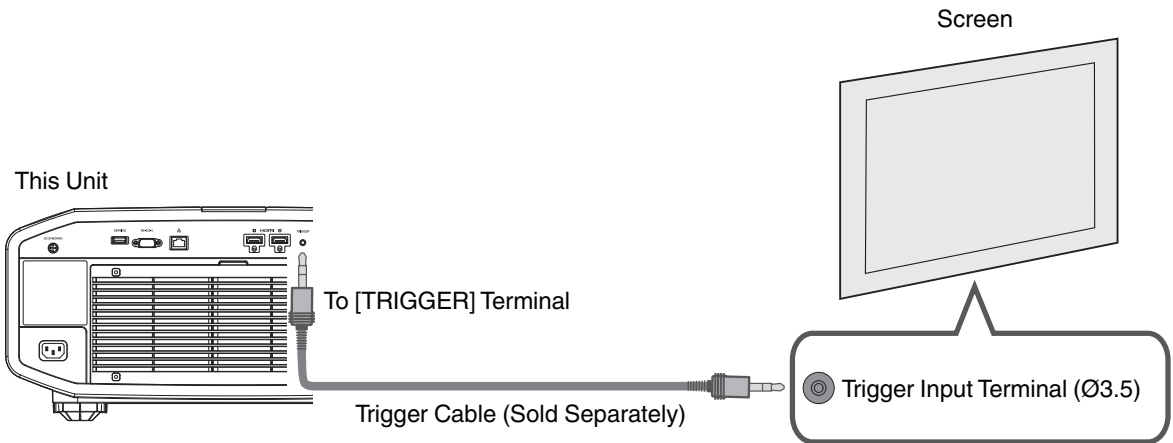

- Do not use it to supply power to other devices.
- Connecting to the audio terminal of another device may cause the device to malfunction or break down.
- Using beyond the rated value will cause the unit to malfunction.
- The trigger terminal outputs a voltage of 12 V. Exercise adequate caution to prevent short circuit.
- The factory setting is "Off". To change the setting, configure the "Trigger" item in the menu (P. 58).

Connecting the Power Cord (Supplied Accessory)

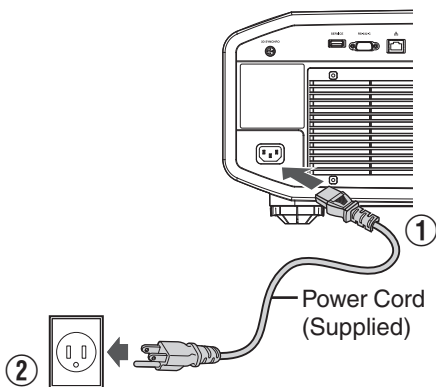

- ① Connect the power cord supplied to the power input terminal on the main unit
- ② Insert the supplied power plug into the wall outlet.

⚠ Precautions to prevent fire and electric shock

- The power consumption of this unit is large. Please connect it directly to the wall outlet.
- When you are not using the projector, please unplug the power cord from the outlet.
- Connect it using only the power cord supplied.
- Do not use a voltage other than the indicated power voltage.
- Do not damage, break or modify the power cord. Do not place a heavy object on the power cord, or heat or pull it. Doing so may damage the power cord.
- Do not unplug the power cord with wet hands.

Viewing Videos

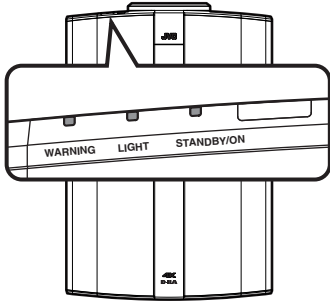
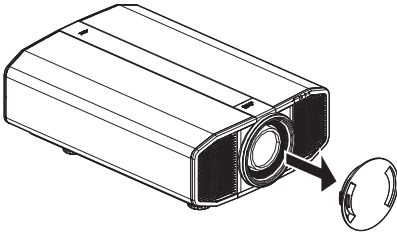

Remote Control

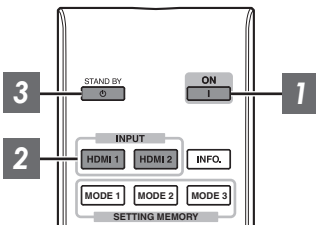

This unit

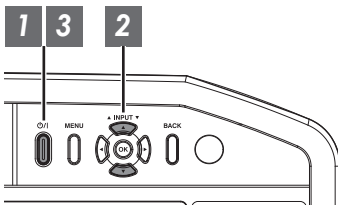

MEMO

- Make sure to remove the lens cover.
- Connect the power cord, and ensure that the “STANDBY/ON” indicator lights up in red.
- During standby in the “ECO Mode”, the “STANDBY/ON” indicator does not light up even when the power cord is correctly connected. In this case, cancel the standby mode by pressing any button on the remote control unit, or use the \odot /I button on the projector unit when you are turning on the power.

1 Turn on the power

Remote control: press the I [ON] button

Projector unit: press the \odot /I button

- The “STANDBY/ON” indicator light switches from red (light off in “ECO Mode”) to green (light goes off after the unit starts up).

“STANDBY/ON” lights up (red)
In standby state



“STANDBY/ON” lights up (green)
When LD block is starting up



“STANDBY/ON” light off
When in “ECO Mode”



2 Choose the image to project

Remote control: press the [HDMI 1] or [HDMI 2] button

Projector unit: press the [INPUT] button to switch the input

- Play back the selected device to project the image.

To hide the image temporarily

Press the [HIDE] button on the remote control

- The “STANDBY/ON” indicator light starts to blink in green.
- Press the [HIDE] button again to resume display of the image.
- The power cannot be turned off when the image is temporarily hidden.

3 Turn off the power

Remote control: press the  [STANDBY] button

Projector unit: press the /I button

- While the “Are you sure you want to turn off?” message is displayed, press the button again.
- The light of the LD block goes off, and the “STANDBY/ON” indicator switches from a green light to a red blinking light.
- After the light goes off, the fan will run for about 10 seconds to cool down the LD block (Cool-down mode). Do not disconnect the power cable while cooling is in progress.
- After about 10 seconds, the “STANDBY/ON” indicator switches from a blinking red to a solid red light.

“STANDBY/ON” blinking (red)
In the Cool-down mode



“STANDBY/ON” lights up (red)
In standby state



- Attach the lens cover.

CAUTION

- The power cannot be turned off within approximately 30 seconds after it has been turned on.
- The power cannot be turned on again while cooling is in progress (10 seconds).
- Pull out the power plug when the unit is not to be used for a prolonged period of time.
- If the indication of indicator differs from the description, refer to “Indicator Display on the Main Unit”P. 75 for details.

Adjusting the Projector Screen

Adjusting the Lens According to the Projection Position

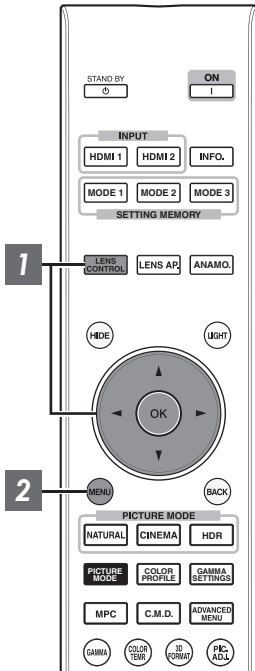

1 Press the [LENS CONTROL] button, and use the [▲▼◀▶] keys to adjust Focus, Zoom (screen size), and Shift (screen position)

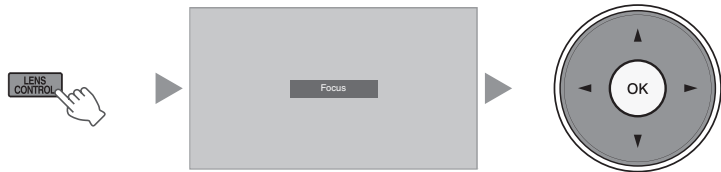

- Pressing the [LENS CONTROL] or [OK] button each time switches the mode in the following sequence: “Focus” → “Zoom” → “Shift” → “Focus”...
- Operation of the lens control feature is disabled when the lens lock is set to “On”.
- For more detailed information, please refer to “Lens Control”P. 51.

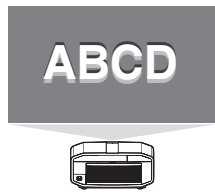

Focus Adjustment

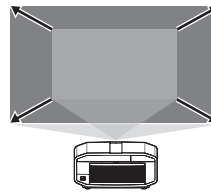

Zoom (Screen Size) Adjustment

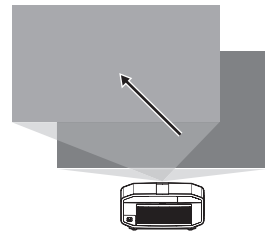

Shift (Screen Position) Adjustment

2 Press the [MENU] button once, or the [BACK] twice, to end adjustment

Setting Screen Correction

1 Set Screen Adjust

By selecting the optimal correction mode according to the characteristics of the screen in use, corrections can be performed to reproduce natural images with balanced colors.

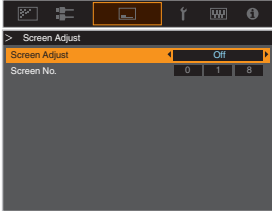

- This item is not available when “Color Profile” is set to “Off”.
- For information on the screen and the corresponding correction mode, please visit our website.

<http://www3.jvckenwood.com/english/projector/screen/>

MEMO

- You can utilize the optional optical sensor and dedicated projector calibration software to make finer adjustments.
For details on the dedicated projector calibration software, please visit our website.

<http://www3.jvckenwood.com/english/download/>

Adjusting the Screen Size (Aspect)

The screen size of the projected image can be adjusted optimally according to the original screen size (aspect) that has been input.

- 1 Press the [MENU] button to display the menu
- 2 Select "Input Signal" → "Aspect" in the menu, then select the setting and press [OK]

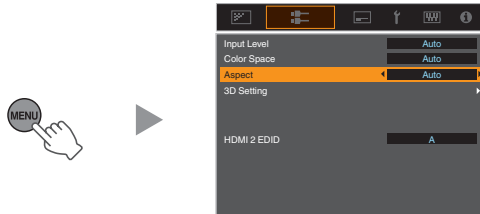

| Setting | Description |
|---------|--|
| Zoom | Magnifies the input image horizontally to the maximum while maintaining its aspect ratio for display. Part of the image that runs off the edge vertically will not be displayed. |
| Auto | Magnifies the input image horizontally or vertically to the maximum while maintaining its aspect ratio for display. |
| Native | Any image below 1920x1080 and 2048x1080 will be scaled 4 times the native resolution of the source. Any source above 1920x1080 will be shown without any scaling. *2048x1080 the exception. |

- 3 Press the [MENU] button to exit

Example of input image and screen size

| Setting \ Input Image Size | Zoom | Auto | Native |
|----------------------------|------|------|--------|
| 720x480 | | | |
| 1920x1080 | | | |

Viewing 3D Movies

By using the 3D Glasses (PK-AG1, PK-AG2, or PK-AG3) and 3D Synchro Emitter (PK-EM1 or PK-EM2), both sold separately, you can enjoy 3D video images.

- For 3D Glasses and 3D Synchro Emitter that are compatible with this unit, please refer to “Optional Accessories”P. 10.

Installing the 3D Synchro Emitter

- 1 Connect 3D Synchro Emitter to the [3D SYNCHRO] terminal on the main unit

Installation Example

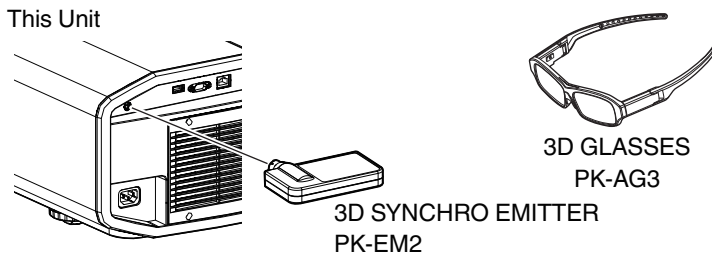

CAUTION

- If PK-EM1 is used, adjust the position of the 3D Synchro Emitter such that the 3D Glasses can receive the signal from the 3D Synchro Emitter.
For more details, please refer to the instruction manual of PK-EM1.

Viewing 3D Movies

1

Connect this unit to a 3D-compatible HDMI device, and turn on the power to play back the 3D video image

- For details on how to play back 3D video images, please refer to the instruction manual of the player or recorder in use.
- This unit supports the following 3D formats.
 - Frame packing
 - Side-by-side
 - Top-and-bottom

Setting the 3D format

① Select “3D Format”

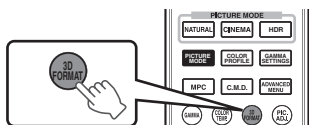

- Pressing the [3D FORMAT] button each time switches the mode in the following sequence: “Auto” → “Side by Side” → “Top and Bottom” → “2D” → “Auto”...
- You can also perform setting from “Input Signal” → “3D Setting” → “3D Format” in the menu.

| Format | Description |
|----------------|---|
| Auto | Automatically determines and sets the format upon receiving 3D signal. |
| Side by Side | Select this setting if the 3D input signal is of the side-by-side format. |
| Top and Bottom | Select this setting if the 3D input signal is of the top-and-bottom format. |
| 2D | Select this setting if 2D images are falsely recognized as 3D ones. |

- * If a signal cannot be displayed as 3D image, selecting the format does not switch the signal to a 3D image. For more information on possible input signals, please refer to “Types of Possible Input Signals” P. 74.
- * In the default setting, “3D Format” is set to “Auto” for automatic projection of 3D images.

2

Turn on the power of the 3D Glasses and put them on

- The PK-AG1 powers on automatically.

Adjusting 3D Movies

3D video images may appear differently to different viewers. It may also be affected by your physical condition at the time of viewing. You are therefore recommended to adjust the video images accordingly.

1

Select “Input Signal” → “3D Setting” from the menu

Adjusting parallax (Parallax)

Adjust the displacement of the image for the left and right eyes separately to obtain the best 3D effect.

- To do so, use the ◀▶ keys to move the cursor.
- Setting range: -15 to +15

Adjusting crosstalk (Crosstalk Cancel)

Double images (overlapping of the left image with the one on the right or vice versa) can be reduced to deliver a clear quality.

- To do so, use the ◀▶ keys to move the cursor.
- Setting range: -8 to +8

2

Press the [MENU] button to exit

Selecting an Image Quality According to the Video Type

Setting the Picture Mode

You can adjust the image quality according to the type of video image you are viewing.

1 Press the [PICTURE MODE] button, and use the [▲▼] keys to select and set the desired “Picture Mode”

- You can also perform the setting by pressing the [MENU] button to display the menu followed by selecting “Picture Adjust” → “Picture Mode”.
- You can also press the “Cinema”, “HDR” or “Natural” button to set the Picture mode directly.
- You can configure more detailed setting items by pressing the [MENU] button to display the menu, followed by selecting “Picture Adjust” → “Picture Mode” and pressing the [OK] button. (P. 44)

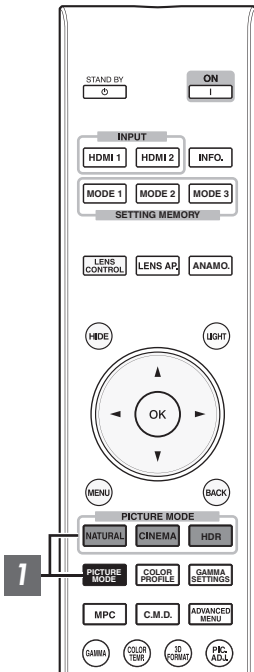

| Item | Description |
|------------------|--|
| Natural | Image quality that focuses on natural color and gradation reproduction. Suitable for drama footage, etc. |
| Cinema | Reproduces the image in vivid colors. Suitable for all movies. |
| HDR*1 | Making full use of the wide color gamut and contrast, this mode is suited for viewing HDR contents such as Ultra HD Blu-ray. |
| Film | Reproduces faithfully the texture of movie films. |
| THX*2 | Image quality certified by THX. |
| User 1 to User 6 | Enables user-defined image quality data to be saved and retrieved. |

*1 If HDR (high dynamic range) signal is detected, the picture mode will automatically switch to “HDR”.

*2 For “THX”, the optimal settings for 2D and 3D signals are stored separately and applied automatically according to the selected mode.

- Edited settings will also be saved separately.
- No changes will be made to the Picture mode name.

Setting the Color Profile

By setting the “Color Profile” (color space information) according to the “Picture Mode”, you can fine-tune the image quality according to the movie you are viewing.

1 Configure “Picture Mode” (P. 31), then select “Picture Adjust”→“Color Profile” in the menu

- The selectable “Color Profile” settings vary according to “Picture Mode”.

“Color Profile”

| Color Profile | Description |
|--------------------|---|
| BT.709 | Color space that is suitable for viewing BT.709 color space contents. |
| BT.2020 | Color space that is suitable for viewing BT.2020 color space contents. |
| DCI | Color space that is suitable for viewing DCI color space contents. |
| Anime. | Color space that is suitable for CG animation works. Ideal for animated works with bright colors. |
| Cinema | Original JVC cinema-specific color gamut that achieves a balance between increased brightness and color vividness. |
| HDR | Color space suitable for HDR content. |
| Film 1 | Color space that is close to the characteristics of Eastman Kodak Company movie films. |
| Film 2 | Color space that is close to the characteristics of FUJIFILM Corporation movie films. |
| THX | Color space of the THX standard. |
| Off | Disables color space adjustment. |
| Custom1 to Custom6 | For saving the color profile data created using the projector calibration software. <ul style="list-style-type: none">• For details on creating and saving the data, please refer to our website. |

List of selectable “Color Profile” according to “Picture Mode”

| Picture Mode | Color Profile |
|--------------------|---------------|
| Natural | BT.709 |
| | BT.2020 |
| | DCI |
| | Anime. |
| | HDR |
| Cinema | BT.709 |
| | BT.2020 |
| | Cinema |
| | DCI |
| | HDR |
| HDR | HDR |
| | BT.2020 |
| | BT.709 |
| | DCI |
| Film | Film 1 |
| | Film 2 |
| THX | THX |
| User 1 to User 6 | BT.709 |
| | BT.2020 |
| | DCI |
| | Anime. |
| | Cinema |
| | HDR |
| | Off |
| Custom1 to Custom6 | |

Adjusting to your Preferred Color (Color Management)

Based on the setting of the selected “Color Profile”, you can adjust each of the following colors according to your preference: Red, Yellow, Green, Cyan, Blue, and Magenta.

1 Press the [ADVANCED MENU] button to display the “Color Profile” menu

2 Set “Color Management” to “On”, and press the [OK] button

- You can also perform setting from “Picture Adjust”→“Color Profile”→“Color Management” in the menu.

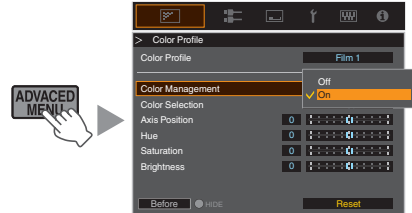

3 Adjust to the preferred color

- Select “Color Selection”, and press the ◀▶ keys to select the color to adjust
 - For color adjustment, select the color from the following: “Red”, “Yellow”, “Green”, “Cyan”, “Blue”, “Magenta”.
- Adjust the selected color

| Item | Setting Range | Description |
|---------------|---------------|--|
| Axis Position | -30 to 30 | Fine-tune the position of the central axis of the selected color. |
| Hue | -30 to 30 | Adjusts the hue (color tone). |
| Saturation | -30 to 30 | Adjusts the color saturation (vividness). -30 (dull) to +30 (vivid) |
| Brightness | -30 to 30 | Adjusts the brightness. -30 (dark) to +30 (bright) |

- Selecting “Reset” resets all the adjustment data.
- Pressing the [HIDE] button on the remote control enables you to check the image before adjustment. Press the [HIDE] button again to return to the adjustment screen.

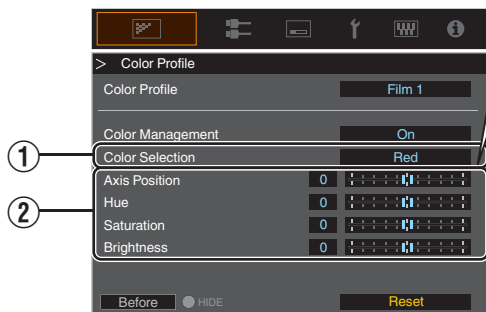
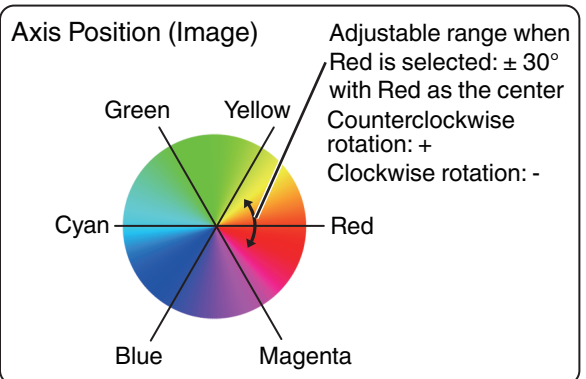

4 Press the [MENU] button to exit

Adjusting Movies for Increased Detail and Sharpness (Multiple Pixel Control)

The new image-processing algorithm developed by JVC helps to create a natural impression that is sharper at areas in focus, and softer at areas that are not in focus, enabling you to enjoy highly detail 4K images with a greater sense of depth.

1 Press the [MPC] button to display the adjustment menu

- You can also perform setting from “Picture Adjust” → “MPC Level” in the menu.

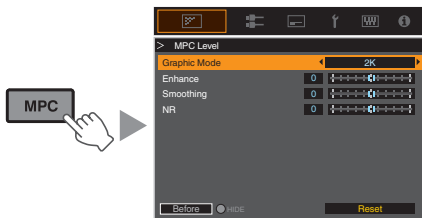

2

Make adjustments according to your preference based on the setting of the selected “Picture Mode”

* The factory setting varies with the “Picture Mode”.

| Item | Setting | Description |
|--------------|---------|--|
| Graphic Mode | 4K/2K | For selecting whether the content you are viewing is of high sharpness such as graphics. It is recommended to set to “4K” when viewing content mastered in 4K. |
| Enhance | 0 to 10 | Enhances the sharpness of the image. |
| Smoothing | 0 to 10 | Enhances the blurriness of the image for a softer effect. |
| NR | 0 to 10 | For reducing the noise of the video image. |

- By increasing the setting range, you can expect enhanced effects.

3

Press the [MENU] button to exit

Toggling between the States before and during Adjustment

Pressing the [HIDE] button on the remote control enables you to toggle between the states before adjustment and during adjustment.

Fine-tuning the Image Quality

Adjusting the Output Value of the Projected Image (Gamma)

You can adjust the output value of the projected image with respect to the video signal input.

Example of gamma adjustment

The overall image appear brighter with respect to the original image, making the dark areas more visible.

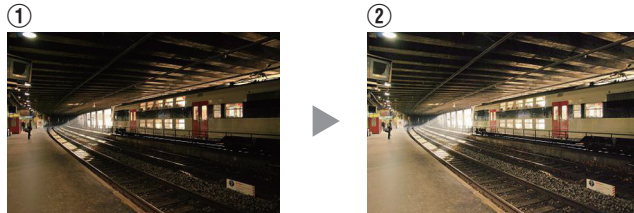
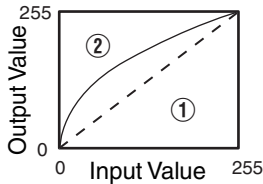

The photos are for illustrative purposes only.

Increases the contrast with respect to the original image, creating a greater sense of depth.

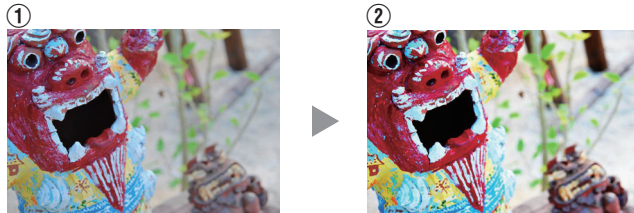
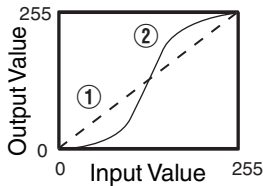

The photos are for illustrative purposes only.

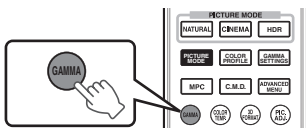

1 Press the [GAMMA] button

- Pressing the [GAMMA] button each time switches the setting in sequence.
- You can also perform the setting by pressing the [MENU] button to display the menu followed by selecting "Picture Adjust" → "Gamma".
- The selectable "Gamma" settings vary according to "Picture Mode".

“Gamma”

| Gamma | | Description |
|---|---|---|
| When “Color Profile” is set to “Film 1” | Film 1 | Image is close to the characteristics of Eastman Kodak Company movie films. |
| | Film 2 | Places more emphasis on the gradation compared to the “Film 1” setting. |
| When “Color Profile” is set to “Film 2” | Film 1 | Places more emphasis on the contrast compared to the “Film 2” setting. |
| | Film 2 | Image is close to the characteristics of FUJIFILM Corporation movie films. |
| 2.2 | The gamma is set to “2.2”, “2.4” and “2.6” respectively. | |
| 2.4 | | |
| 2.6 | | |
| Cinema 1 | Places emphasis on the gradation. | |
| Cinema 2 | Places emphasis on the contrast. | |
| HDR(ST.2084) | Suited for viewing HDR content such as UHD BD (HDR10). | |
| HDR(Hybrid Log) | Suited for viewing HDR content such as HDR broadcast and streaming sources. | |
| THX | Video of the THX standard. | |
| Custom 1 to Custom 3 | Enables fine adjustment of gamma according to preference. | |

Selectable “Gamma” settings according to “Picture Mode”

| Picture Mode | Gamma |
|--|----------------------|
| Film | Film 1 |
| | Film 2 |
| | Custom 1 to Custom 3 |
| Cinema Natural HDR User 1 to User 6 | 2.2 |
| | 2.4 |
| | 2.6 |
| | Cinema 1 |
| | Cinema 2 |
| | HDR(ST.2084) |
| | HDR(Hybrid Log) |
| | Custom 1 to Custom 3 |
| THX | THX |

Fine-tuning to the Preferred Gamma Setting

You can perform fine adjustments based on the selected gamma adjustment setting.

1 Press the [GAMMA SETTINGS] button to display the gamma menu

- You can also perform setting from “Picture Adjust”→“Gamma” in the menu.

2 Adjust to the preferred setting

- Select the color to be adjusted from “Color Selection” and adjust the “Picture Tone”, “Dark Level” and “Bright Level”.

Adjustment item and its setting

| Item | Description | Setting |
|-----------------|--|---|
| Color Selection | For selecting the color for adjusting “Picture Tone”, “Dark Level” and “Bright Level”. | White / Red / Green / Blue |
| Picture Tone | Adjusts the overall brightness automatically for a well-balanced result without compromising the gradation of the image. | -16 (darkens image for an underexposed effect) to +16 (brightens image for an overexposed effect) |
| Dark Level | Adjusts the dark areas of the input image. • To do so, use the ◀▶ keys to move the cursor. | -7 (darkens the shadows) to +7 (brightens the shadows) |
| Bright Level | Adjusts the bright areas of the input image. • To do so, use the ◀▶ keys to move the cursor. | -7 (darkens the highlights) to +7 (brightens the highlights) |

Selecting the Base Correction Value (Initial Value) for Adjustment

- Selecting one of the “Custom 1” to “Custom 3” settings in “Gamma” allows you to select the “Correction Value”.
- Select the base “Correction Value” for adjustment using the ◀▶ keys.
- The selectable correction values vary according to “Picture Mode”. (Refer to the table below.)

List of selectable “Correction Value” according to “Picture Mode”

| Picture Mode | Correction Value |
|--|------------------|
| Film | Film 1 |
| | Film 2 |
| | Import |
| Cinema Natural HDR User 1 to User 6 | 1.8 |
| | 1.9 |
| | 2.0 |
| | 2.1 |
| | 2.2 |
| | 2.3 |
| | 2.4 |
| | 2.5 |
| | 2.6 |
| | Cinema 1 |
| | Cinema 2 |
| | HDR(ST.2084) |
| | HDR(Hybrid Log) |
| Import | |

When “Correction Value” is set to “Import”

- By selecting “Import” for “Correction Value”, the gamma data created externally can be selected as the base setting value for adjustment.
- The factory setting for “Import” is “2.2”.
- You can use the calibration software to customize the gamma data adjustment, and import the created gamma data.

Please check with your authorized dealer for details.

Gamma Adjustment

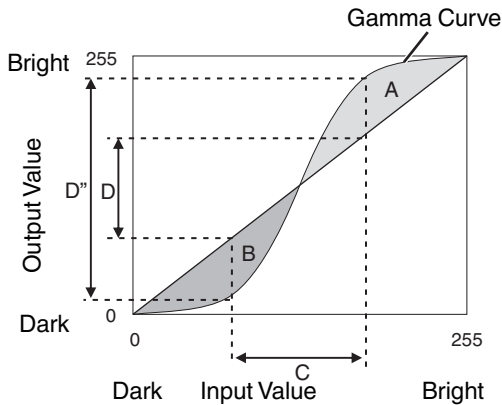

- When the gamma curve is a straight line:
The brightness and contrast of the video input will be the same as that of the video output.
- Area for which the gamma curve is above the straight line (A):
Video output appears brighter than the input.
- Area for which the gamma curve is below the straight line (B):
Video output appears darker than the input.
- Area for which the slope of the gamma curve is steep (midtone) (C):
The grayscale range of the video output becomes wider, and the contrast increases (D→D').

Reducing the After-image of Fast-moving Images (Blur Reduction)

Low Latency

For changing the low latency setting.

You are recommended to set to "On" for contents requiring short latency such as games.

- 1 Press the [MENU] button to display the menu and select "Picture Adjust" → "Blur Reduction" → "Low Latency"

| Setting | Description |
|---------|---|
| On | Performs the low latency setting. |
| Off | Does not perform the low latency setting. |

* "Clear Motion Drive" cannot be set when "Low Latency" is set to "On".

Clear Motion Drive (C.M.D.)

Optimal interpolation according to the content is made possible with the new high-definition image interpolation technique.

For some scenes, interpolation may cause distortion in the image. In this case, set to "Off".

■ Original Image

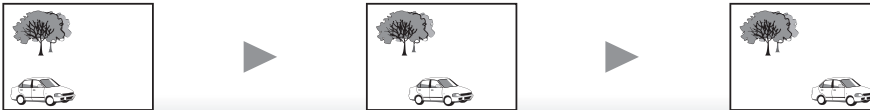

■ Interpolation Enabled



Intermediate Frame Generation

Intermediate Frame Generation

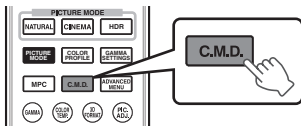

- 1 Press the [C.M.D.] button

- Pressing the [C.M.D.] button each time switches the mode in the following sequence: "Off" → "Low" → "High" → "Inverse Telecine" → "Off"...

| Setting | Description |
|------------------|--|
| Off | Interpolation is not performed. |
| Low | Improves motion lag for movie type images. |
| High | Improves motion lag fast moving sports type images. |
| Inverse Telecine | 60i/60p video images such as those of TVs and DVDs. Suitable for original images that are 24-frame film sources. <ul style="list-style-type: none"> • Does not function for 24p video images. |

* C.M.D. is the abbreviation for Clear Motion Drive.

* This item cannot be set when "Low Latency" is set to "On".

Motion Enhance

You can reduce motion blur with this function enhancing the response of D-ILA image devices. If the image outline is unnatural, set this item to "Off".

7 Press the [MENU] button to display the menu and select "Picture Adjust"→"Blur Reduction"→"Motion Enhance"

| Setting | Description |
|---------|--|
| Off | Does not perform correction. |
| Low | Reduces image blurring. |
| High | Further reduces image blurring than "Low". |

Adjustments and Settings in the Menu

Pressing the [MENU] button displays the menu.

Press the [▲▼◀▶] keys to select an item, followed by pressing the [OK] button to confirm the selection.

List of Menu Items

Picture Adjust

| | |
|-----------------------------------|-------|
| ▶ Picture Mode | P. 31 |
| ↳ Dynamic CTRL | P. 44 |
| ↳ LD Power | P. 44 |
| ↳ Aperture | P. 44 |
| ↳ User Name Edit | P. 44 |
| ▶ Color Profile | P. 32 |
| ↳ Color Management | P. 34 |
| ▶ Color Temp. | P. 45 |
| ▶ Gamma | P. 36 |
| ↳ Picture Tone | P. 38 |
| ↳ Dark Level / Bright Level | P. 38 |
| ▶ MPC Level | P. 35 |
| ▶ Blur Reduction | P. 40 |
| ▶ Contrast | P. 48 |
| ▶ Brightness | P. 48 |
| ▶ Color | P. 48 |
| ▶ Tint | P. 48 |

Input Signal

| | |
|---------------------|-------|
| ▶ Input Level | P. 49 |
| ▶ Color Space | P. 49 |
| ▶ Aspect | P. 49 |
| ▶ 3D Setting | P. 29 |
| ▶ HDMI 2 EDID | P. 49 |

Installation

| | |
|------------------------------|-------|
| ▶ Installation Mode | P. 50 |
| ▶ Lens Control | P. 26 |
| ↳ Focus | P. 26 |
| ↳ Zoom | P. 26 |
| ↳ Shift | P. 26 |
| ↳ Image Pattern | P. 51 |
| ↳ Lock | P. 51 |
| ↳ Lens Center | P. 51 |
| ▶ Pixel Adjust | P. 52 |
| ↳ Adjust | P. 52 |
| ↳ Adjust Area | P. 52 |
| ↳ Adjust Color | P. 52 |
| ↳ Adjust Pattern | P. 52 |
| ↳ Adjust Pattern Color | P. 52 |
| ↳ Adjust (Pixel) | P. 52 |
| ↳ Adjust (Fine) | P. 52 |
| ↳ Reset | P. 52 |
| ▶ Mask | P. 56 |
| ▶ Anamorphic | P. 56 |
| ▶ Screen Adjust | P. 27 |
| ▶ Installation Style | P. 56 |
| ▶ Keystone | P. 56 |
| ▶ Pincushion | P. 57 |
| ▶ High Altitude Mode | P. 57 |

Display Setup

| | |
|------------------------|-------|
| ▶ Back Color | P. 57 |
| ▶ Menu Position | P. 57 |
| ▶ Signal Display | P. 57 |
| ▶ Logo | P. 57 |
| ▶ Language | P. 57 |

Function

| | |
|-------------------------|-------|
| ▶ Trigger | P. 58 |
| ▶ Off Timer | P. 58 |
| ▶ ECO Mode | P. 58 |
| ▶ Network | P. 59 |
| ▶ Remote Code | P. 59 |
| ▶ Hide Mode | P. 60 |
| ▶ Factory Reset | P. 60 |
| ▶ Software Update | P. 60 |

Information

| | |
|---------------------|-------|
| ▶ Information | P. 60 |
|---------------------|-------|



Picture Adjust

Picture Mode

You can adjust the image quality according to the type of video image you are viewing.

- ➔ “Setting the Picture Mode” (P. 31)

You can configure the following setting items by pressing the [MENU] button to display the menu, followed by selecting “Picture Adjust” → “Picture Mode” and pressing the [OK] button.

Dynamic CTRL

Expands the dynamic range of video expression through controlling the brightness of the light source based on image analysis.

* Adequate brightness control for some scenes may not be possible. In that case, set “Clear Motion Drive (C.M.D.)” to “Off”.

- ➔ “Reducing the After-image of Fast-moving Images (Blur Reduction)” (P. 40)

| Setting | Description |
|---------|--|
| Off | Does not control. |
| Mode 1 | Expands the dynamic range of video expression. Weaker control than “Mode 2”. |
| Mode 2 | Expands the dynamic range of video expression. Stronger control than “Mode 1”. |

LD Power

For changing the brightness through controlling the light source output.

| Setting | Description |
|---------|-------------------|
| Low | Brightness (low) |
| Mid | Brightness (mid) |
| High | Brightness (high) |

Aperture

For changing the brightness through controlling the aperture.

- Setting range: -15 (stops down) to 0 (opens up)

User Name Edit

You can edit the “User 1” to “User 6” names in the Picture mode.

- Characters that are usable include alphabets (upper or lower case), numeric characters, and symbols.
- Enter not more than 10 characters.

The screenshot shows the "User Name Edit" screen with a keyboard overlay. The text "Name User 1" is visible at the top. The keyboard has a grid of characters. Annotations include:

- Selection Cursor:** Points to the letter 'A' in the first row of the keyboard.
- Input Cursor:** Points to the text field containing "User 1".
- After entry is complete, select "OK" and press the [OK] button:** Points to the "OK" button at the bottom right of the keyboard.

Color Profile

By setting the “Color Profile” (color space information) according to the “Picture Mode”, you can fine-tune the image quality according to the movie you are viewing.

- ➔ “Setting the Color Profile” (P. 32)

Color Management

Each of the colors is adjustable according to the user’s preference.

- ➔ “Adjusting to your Preferred Color (Color Management)” (P. 34)

Color Temp.

For setting the color temperature of the video image.

- When “Picture Mode” is set to “THX”, the setting is fixed at 6500K.
- The selectable “Color Temp.” settings vary according to “Picture Mode”.

“Color Temp.”

| Color Temp. | Description |
|----------------------|---|
| Xenon 1 | Color temperature that reproduces the characteristics of a xenon lamp used in cinemas. <ul style="list-style-type: none">• Xenon 1: A light source color that is emitted by a film projector• Xenon 2: A light source color emitted by a projector used for digital cinema |
| Xenon 2 | |
| 5500K | Increasing the value enhances the blue tone of the video image, while decreasing the value enhances the red tone. |
| 6500K | |
| 7500K | |
| 9300K | |
| HDR | Color temperature suitable for viewing HDR content. |
| High Bright | Color temperature that gives priority to brightness. |
| Custom 1 to Custom 2 | The color temperature of video images can be adjusted manually and saved as one of the three customized settings. |

List of selectable “Color Temp.” according to “Picture Mode”

| Picture Mode | Color Temp. |
|------------------------------------|----------------------|
| Film | Xenon 1 |
| | Xenon 2 |
| | Custom 1 to Custom 2 |
| Cinema | 5500K |
| | 6500K |
| | 7500K |
| | 9300K |
| | Xenon 1 |
| | Xenon 2 |
| | High Bright |
| | HDR |
| | Custom 1 to Custom 2 |
| Natural HDR User 1 to User 6 | 5500K |
| | 6500K |
| | 7500K |
| | 9300K |
| | High Bright |
| | HDR |
| | Custom 1 to Custom 2 |
| THX | 6500K |

Correction Value

For setting the base color temperature for the adjustment of “Gain Red” / “Gain Green” / “Gain Blue” / “Offset Red” / “Offset Green” / “Offset Blue” when one of the “Custom 1” to “Custom 2” setting is selected in “Color Temp.”.

Gain Red / Gain Green / Gain Blue

Adjusts each color in the bright parts of the video image.

- Setting range: -255 (reduces the red/green/blue tone) to 0 (no adjustment)

Offset Red / Offset Green / Offset Blue

Adjusts each color in the dark areas of the video image.

- Setting range: -50 (reduces the red/green/blue tone) to 0 (no adjustment) to +50 (enhances the red/green/blue tone)
- Setting “Color Temp.” to “Custom 1”, “Custom 2” or “HDR” allows you to select and adjust a base correction value (initial value) for adjustment.
- The selectable correction values vary according to “Picture Mode”. (Refer to the table below.)

List of selectable “Correction Value” according to “Picture Mode”

| Picture Mode | Correction Value |
|------------------------------------|------------------|
| Film | Xenon 1 |
| | Xenon 2 |
| Cinema | Xenon 1 |
| | Xenon 2 |
| | 5500K |
| | 6500K |
| | 7500K |
| | 9300K |
| | High Bright |
| Natural HDR User 1 to User 6 | 5500K |
| | 6500K |
| | 7500K |
| | 9300K |
| | High Bright |

Gamma

You can adjust the output value of the projected image with respect to the video signal input.

- ➔ “Adjusting the Output Value of the Projected Image (Gamma)” (P. 36)

Correction Value

For setting the base gamma for the adjustment of “Picture Tone”, “Dark Level” and “Bright Level” when one of the “Custom 1” to “Custom 3” settings is selected in “Gamma”.

- ➔ “Fine-tuning to the Preferred Gamma Setting” (P. 38)

Picture Tone

Adjusts the overall brightness automatically for a well-balanced result without compromising the gradation of the image.

- ➔ “Fine-tuning to the Preferred Gamma Setting” (P. 38)

Dark Level / Bright Level

You can adjust the image quality to produce a sharp contrast in the brightness.

- ➔ “Fine-tuning to the Preferred Gamma Setting” (P. 38)

MPC Level

You can enjoy natural, expressive 4K images with a stronger sense of depth.

- ➔ “Adjusting Movies for Increased Detail and Sharpness (Multiple Pixel Control)” (P. 35)

Graphic Mode

For selecting whether the content you are viewing is of high sharpness such as graphics.

It is recommended to set to “4K” when viewing content mastered in 4K.

- Setting values: 4K, 2K

Enhance

For adjusting the high-frequency areas. Increasing the value enhances the definition for a sharper image quality.

- Setting range: 0 to 10

Smoothing

For adjusting the low-frequency areas. Increasing the value enhances the blurriness of the image for a softer effect.

- Setting range: 0 to 10

NR

Prevents noise from becoming too pronounced.

- Setting range: 0 (weak) to 10 (strong)

Blur Reduction

For reducing the after-image, which occurs in a fast-moving scene.

- ➔ “Reducing the After-image of Fast-moving Images (Blur Reduction)” (P. 40)

Contrast

For adjusting the white level point to avoid clipping or over saturation.

- Setting range: -50 (little difference in brightness) to +50 (large difference in brightness)

Brightness

For adjusting the black level point to avoid clipping or over saturation.

- Setting range: -50 (darker) to +50 (brighter)

Color

For adjusting the color density of the video image.

- Setting range: -50 (lighter) to +50 (deeper)

Tint

For adjusting the hue of the video image.

- Setting range: -50 (reddish) to +50 (greenish)

Input Signal

Input Level

For setting the dynamic range (gradation) of the video input.

If the image is not displayed properly even after selecting “Auto”, select an appropriate setting.

- If the dynamic range is not appropriate, the bright areas become overexposed, and the dark areas become underexposed.

| Setting | Description |
|------------------|---|
| Auto | Sets the input signal level automatically. |
| 16-235 (Video) | Select this setting if you are inputting video signals (dynamic range: 16 - 235). |
| 0-255 (PC) | Select this setting if you are inputting PC signals (dynamic range: 0 - 255). |
| 16-255 (S.White) | Select this setting when inputting Super White-compatible device signals (dynamic range: 16 - 255). |

Color Space

For setting the color space of the input signal.

If the image is not displayed properly even after selecting “Auto”, select an appropriate setting.

| Setting | Description |
|----------|---|
| Auto | Detects “YCbCr444”, “YCbCr422”, and “RGB” automatically. |
| YCbCr444 | Select this setting when inputting YCbCr (4:4:4) video signals. |
| YCbCr422 | Select this setting when inputting YCbCr (4:2:2) video signals. |
| RGB | Select this setting when inputting RGB video signals. |

Aspect

The screen size of the projected image can be adjusted optimally according to the original screen size (aspect) that has been input.

- ➔ “Adjusting the Screen Size (Aspect)” (P. 28)

3D Setting

For setting 3D movies for viewing.

- ➔ “Viewing 3D Movies” (P. 29)

HDMI 2 EDID

For changing the EDID mode of the [HDMI 2] terminal. Set to “A” under normal condition.

Images with resolution 1920x1080 or lower may not be displayed when some old devices are used.

In that case, connect to the [HDMI 2] terminal and set “HDMI 2 EDID” to “B”.

- * EDID (Extended Display Identification Data) refers to the information, such as supported resolutions, exchanged between devices.



Installation

Installation Mode

Collectively manages the setting values of “Lens Control”, “Pixel Adjust”, “Mask”, “Anamorphic” and “Screen Adjust”.

- * The lens position may be shifted slightly with respect to the position that was saved.

Mode Select

For selecting the group to save and retrieve the setting values.

- Setting values: Mode 1 to Mode 10
- * The name of the setting value can be changed using “Name Edit”.

Name Edit

For editing the name of Installation Mode.

- Characters that are usable include alphabets (upper or lower case), numeric characters, and symbols.
- Enter not more than 10 characters.



Mode Copy

For copying the setting values managed by the current Installation Mode to another mode.

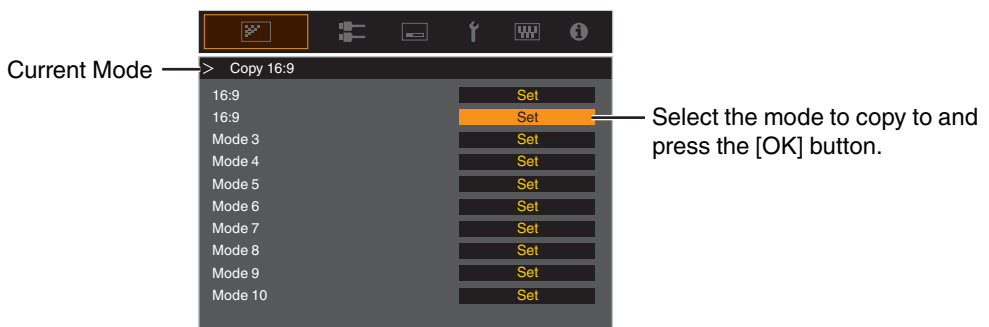

Lens Control

Focus / Zoom / Shift

For adjusting the lens according to the projection position

- ➔ “Adjusting the Lens According to the Projection Position” (P. 26)

Image Pattern

For setting whether to display the lens adjustment pattern.

| Setting | Description |
|---------|--|
| Off | Displays external signals, and does not display the lens adjustment pattern. |
| On | Displays the lens adjustment pattern. |

Lock

For setting whether to lock or unlock the lens.

Setting to “On” to lock the lens allows you to preserve the adjustment status of the lens.

| Setting | Description |
|---------|---|
| Off | Does not lock the lens. |
| On | Locks the lens to prevent any erroneous operation on the adjustments. <ul style="list-style-type: none">• Even when “On”, the lens will be in the mode selected by “Installation Mode”. |

Lens Center

Returns the lens position to the center.

Pixel Adjust

For correcting the phase shifting between each RGB color by adjusting the pixel.

Adjust

For setting the adjustment feature to On or Off.

Adjust Area

| Setting | Description |
|---------|---|
| Whole | Adjusts the entire image. |
| Zone | Enables fine adjustment of each area by dividing the screen evenly into 10 vertical and horizontal zones. |

Adjust Color

For selecting the color to adjust (“Red” or “Blue”).

Adjust Pattern

| Setting | Description |
|---------|---|
| Off | Displays the external signals without displaying the test pattern for adjustment. |
| On | Displays the test pattern for adjustment. |

Adjust Pattern Color

For setting the color of the adjustment pattern displayed during adjustment to “White” or “Yellow / Cyan”.

Adjust (Pixel)

When “Adjust Area” is set to “Whole”, adjustment can be made by moving in units of one pixel on the screen of the color selected in “Adjust Color”.

➔ “Whole Adjust (Pixel) Operation Procedure” (P. 53)

- Adjustment cannot be made when “Adjust Area” is set to “Zone”.

| Setting | Description |
|----------------|--|
| H (Horizontal) | Setting range: -2 (moves red/blue to the left) to +2 (moves red/blue to the right) |
| V (Vertical) | Setting range: -2 (moves red/blue downward) to +2 (moves red/blue upward) |

Adjust (Fine)

When “Adjust Area” is set to “Whole”, adjustment can be made by moving in units of 1/8 pixel on the screen of the color selected in “Adjust Color”.

➔ “Whole Adjust (Fine) Operation Procedure” (P. 54)

When “Adjust Area” is set to “Zone”, the screen is divided evenly into 10 vertical and horizontal zones, and fine adjustment of each area is possible.

➔ “Zone Adjust Operation Procedure” (P. 55)

| Setting | Description |
|----------------|--|
| H (Horizontal) | Setting range: -31 (moves red/blue to the left) to +31 (moves red/blue to the right) |
| V (Vertical) | Setting range: -31 (moves red/blue downward) to +31 (moves red/blue upward) |

Reset

Restores all pixel adjustment data to the factory default.

Whole Adjust (Pixel) Operation Procedure

For making general adjustments to slight color fringing in the horizontal/vertical directions of the video image.

- ① Set “Adjust Area” to “Whole”
- ② Select “Adjust Color” and “Adjust Pattern Color”
- ③ Select “Adjust (Pixel)”, and press the [OK] button
 - The Adjustment mode is activated, and the selected adjustment pattern and Adjustment (Pixel) window are displayed.

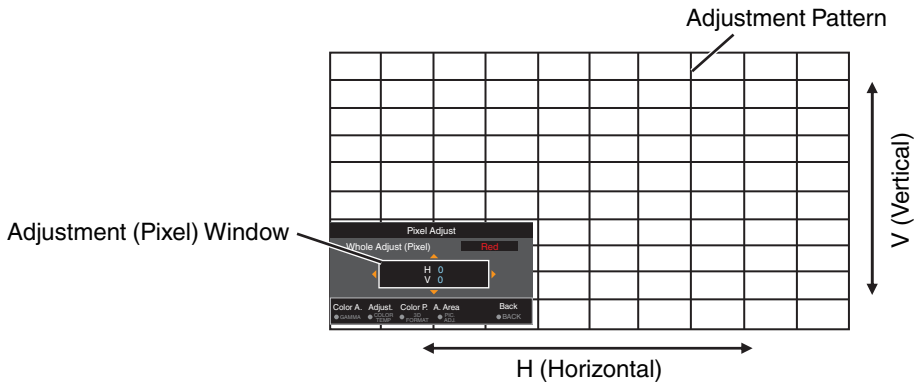

- ④ Use the [▲▼◀▶] keys to move and adjust the vertical and horizontal pixels of the entire zone
 - The adjustment setting appears at the center of the Adjustment (Pixel) window.

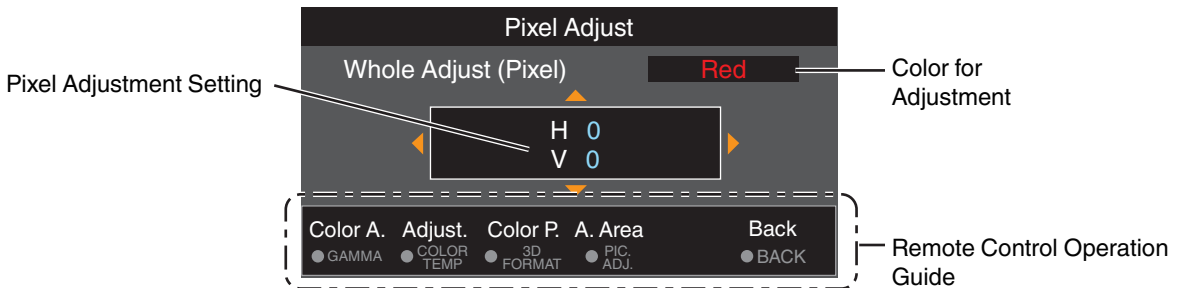

- ⑤ After adjustment is complete, press the [BACK] button twice to exit the Adjustment mode

Remote Control Operation Guide

| Button Name | Function | Description of Operation |
|---------------|----------|--|
| [GAMMA] | Color A. | Changes “Adjust Color”. |
| [COLOR TEMP.] | Adjust | Switches between “Adjust (Pixel)” and “Adjust (Fine)”. <ul style="list-style-type: none"> • Switches to “Adjust (Pixel)” when “Adjust Area” is set to “Zone”. |
| [3D FORMAT] | Color P. | Changes “Adjust Pattern Color”. |
| [PIC ADJ.] | A. Area | Switches “Adjust Area”. <ul style="list-style-type: none"> • A zone cursor appears on the adjustment pattern when the “Zone” setting is selected. |

Whole Adjust (Fine) Operation Procedure

For making general adjustments on the misalignment of the entire screen using “Adjust (Pixel)”, followed by making fine adjustments.

- ① Set “Adjust Area” to “Whole”
- ② Select “Adjust Color” and “Adjust Pattern Color”
- ③ Select Adjust (Fine), and press the [OK] button
 - The Adjustment mode is activated, and the selected adjustment pattern and Fine window are displayed.
 - The adjustable range may be smaller depending on the pixels being adjusted on the entire screen.

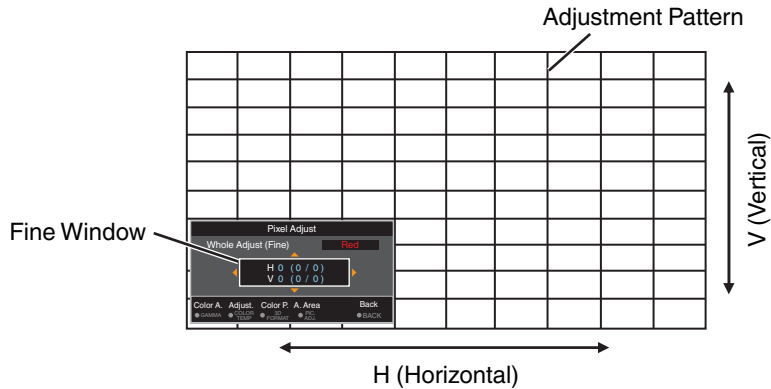

- ④ Use the [\blacktriangle \blacktriangledown \blacktriangleleft \blacktriangleright] keys to move and adjust the vertical and horizontal pixels of the entire zone

- The adjustment setting appears at the center of the Fine window.

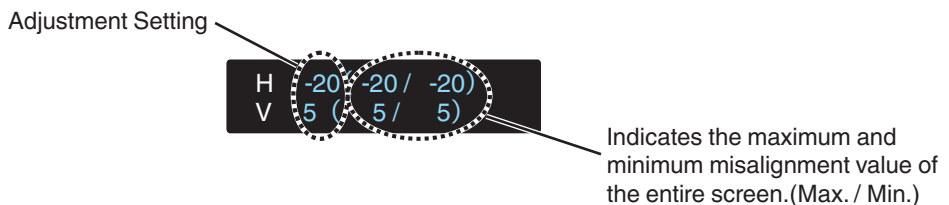
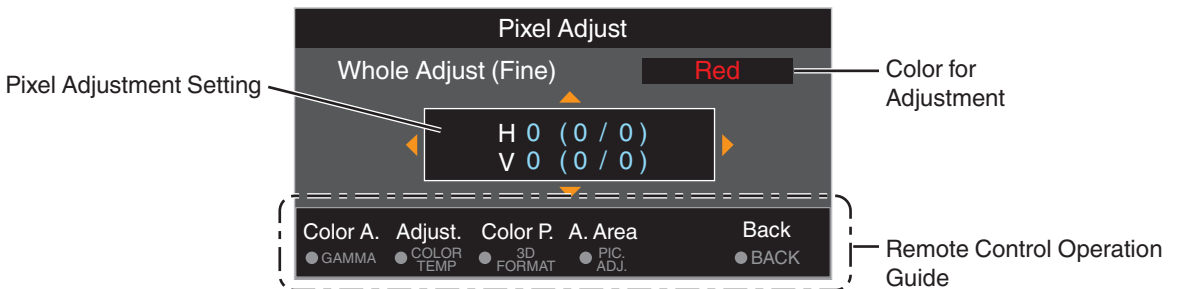

- ⑤ After adjustment is complete, press the [BACK] button twice to exit the Adjustment mode

MEMO

- If both the maximum overall screen misalignment of H (horizontal direction) and V (vertical direction) are “31”, you cannot select a value that is larger than the displayed setting even when the adjustment setting is lower than the maximum value.
- If the minimum overall screen misalignment is “-31”, you cannot select a value that is smaller than the displayed setting even when the adjustment setting is higher than the minimum value.

Zone Adjust Operation Procedure

For fine-tuning misalignments on a part of the screen after adjusting the overall screen misalignment using “Adjust (Pixel)” and “Adjust (Fine)”.

- The screen can be divided vertically and horizontally into 10 sections for partial adjustments to be made.
- ① Set “Adjust Area” to “Zone”
 - ② Select “Adjust Color” and “Adjust Pattern Color”
 - ③ Select Adjust (Fine), and press the [OK] button
 - The Adjustment mode is activated, and the selected adjustment pattern and Zone Adjustment window are displayed.
 - The adjustable range may be smaller depending on the pixels being adjusted on the entire screen.

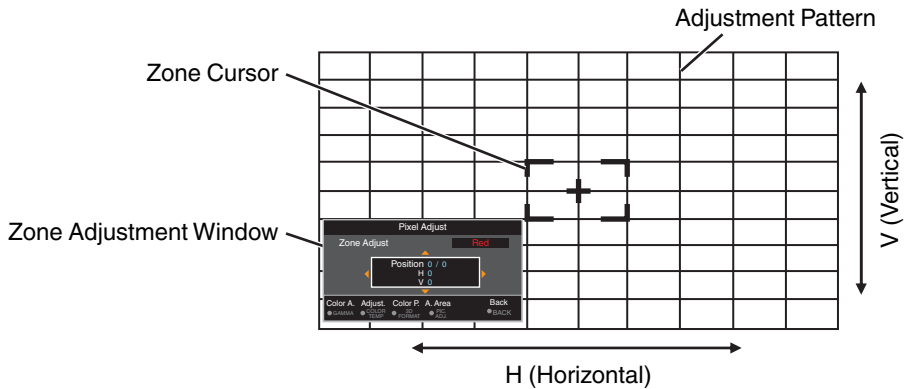

- ④ Press the [▲▼◀▶] keys to move the cursor to the point to be adjusted
- ⑤ Press the [OK] button to enter the Adjustment mode
- ⑥ Use the [▲▼◀▶] keys to move and adjust the vertical and horizontal pixels of the entire zone
 - The adjustment setting appears at the center of the Zone Adjustment window.

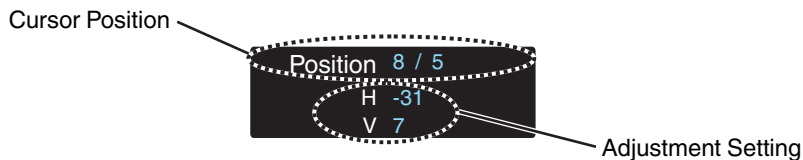
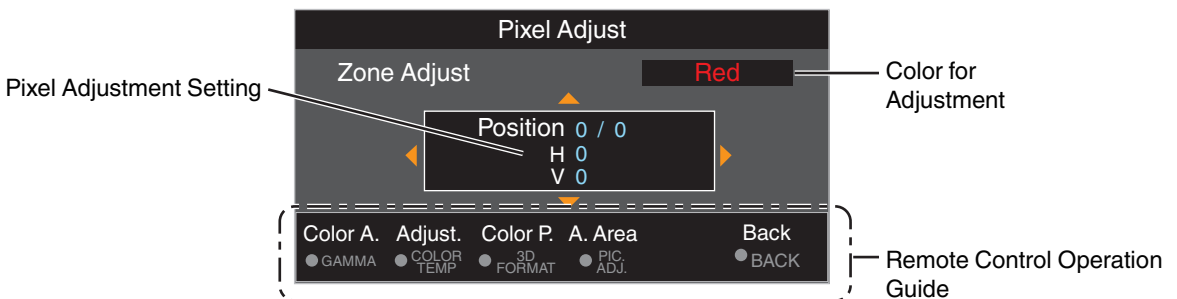

- ⑦ After adjustment is complete, press the [BACK] button twice to exit the Adjustment mode

Mask

For hiding the peripheral area of the image with a mask (black strip).

| Setting | Description |
|---------|---|
| Off | Not masked. |
| On | Hides the ranges specified in “Top”, “Bottom”, “Left” and “Right” by masking (with black strips). |

■ Off



■ On



Mask: black strip around the periphery

“Top” / “Bottom” / “Left” / “Right”

For specifying the ranges to hide by masking (with black strips).

- Setting range: 0 to 220

Anamorphic

Configure this setting when an anamorphic lens is used.

| Setting | Description |
|---------|--|
| Off | Projects the 2.35:1 image without any changes. |
| A | Projects the 2.35:1 image with it stretched in the vertical direction only. |
| B | Projects the 16:9 image with it compressed in the horizontal direction only. |

Screen Adjust

By selecting the optimal correction mode according to the characteristics of the screen in use, corrections can be performed to reproduce natural images with balanced colors.

- ➔ “Setting Screen Correction” (P. 27)

Installation Style

For setting to “Front”, “Ceiling Mount (F)”, “Rear”, or “Ceiling Mount (R)” according to the installation status of the projector.

- “Front” or “Ceiling Mount (F)” is set when projector is installed in the front with respect to the screen.
- “Rear” or “Ceiling Mount (R)” is set when projector is installed in the rear with respect to the screen.

Keystone

For correcting any keystone distortion that occurs when the projector is installed at an angle with respect to the screen.

- Vertical setting range: -16 to +16
 - * Increasing the value changes the aspect slightly.
 - * This function cannot be used if “Pincushion” is set.

Pincushion

Corrects the geometric distortion that occurs when projecting on a curved screen.

- Setting range: 0 to 16
- * When using the projector with the lens shifted in the vertical direction, the amount of distortion at the upper and lower ends may be different and the curvature distortion may not be fully corrected.
- * This function cannot be used if “Keystone” is set.

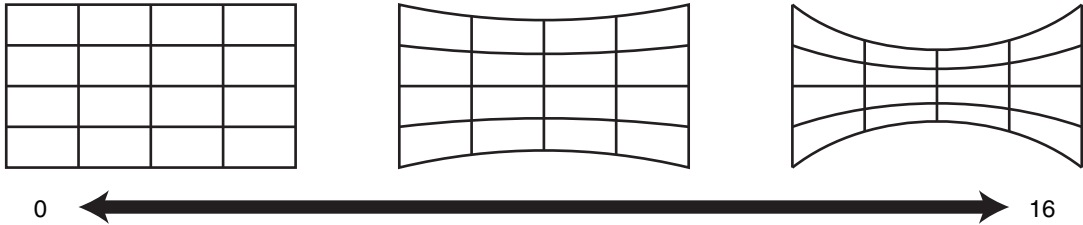

High Altitude Mode

For setting the high altitude mode to “On” or “Off”.

Set to “On” when using the projector at a location of low atmospheric pressure (higher than 900 m above sea level).

↑ Display Setup

Back Color

For setting the color of the background to “Blue” or “Black” when there is no signal input.

Menu Position

For setting the display position of the menu.

Signal Display

For setting the display of the input information to “On” or “Off”.

| Setting | Description |
|---------|--|
| Off | Not displayed. |
| On | Shows the input terminal for 5 seconds when input is switched. |

Logo

For setting the display of logo during startup to “On” or “Off”.

| Setting | Description |
|---------|---|
| Off | Not displayed. |
| On | Displays the “D-ILA” logo for 5 seconds during startup. |

Language

For setting the display language to “English”, “Deutsch”, “Español”, “Italiano”, “Français”, “Português”, “Nederlands”, “Polski”, “Norsk”, “Русский”, “中文”, “繁體中文”, or “日本語”.



Function

Trigger

For setting whether to supply a 12 V output to devices such as an external screen equipped with a trigger function.

| Setting | Description |
|-------------------------------|---|
| Off | No output. |
| Power | Outputs control signals (12 V) from the trigger terminal when the power is turned on. |
| Anamo | Outputs control signals when the “Anamorphic” setting is switched from “Off” to “A” or “B”. |
| Inst. Mode 1 to Inst. Mode 10 | Outputs control signals when the “Installation Mode” number to be retrieved is the same as the number configured. |

* When a setting other than “Off” is selected, the control signal output is stopped when the cooling function starts once the power is turned off.

Off Timer

For setting the duration before the power turns off automatically when the projector is not operated.

• Setting values: “Off”, “1 Hour”, “2 Hours”, “3 Hours” and “4 Hours”

* The setting will be retained even after the Off Timer operation has completed.

ECO Mode

| Setting | Description |
|---------|--|
| On | Enables “ECO Mode” to minimize power consumption in the Standby mode. <ul style="list-style-type: none"> • RS-232C / LAN communication cannot be used in the Standby mode. • If there is no signal transmission and operation for 20 minutes while an image is projected, the power management switches the equipment automatically into standby mode. |
| Off | Select this option to control via RS-232C / LAN communication in the Standby mode or if Control4 is to be used. |

* If this unit enters into standby while “ECO Mode” is set to “On”, all the indicators on the unit including the “STANDBY/ON” indicator are turned off. To turn on the power from this state, use the [STANDBY/ON] button on the unit. Alternatively, press any button on the remote control once to cancel the standby mode then press the [ON] button on the remote control.

Network

For specifying the settings for external control from a PC or smartphone.

| Setting | | Description |
|-----------------|-----|--|
| DHCP Client | On | Obtains the IP address automatically from the DHCP server inside the connected network. |
| | Off | For configuring the network settings manually. |
| IP Address | | For configuring the IP address. |
| Subnet Mask | | For configuring the subnet mask. |
| Default Gateway | | For configuring the default gateway. |
| MAC Address | | Displays the MAC address of the unit. |
| Set | | Applies the network settings. |
| Control4 SDDP | | Set to "On" to allow Control4 SDDP to detect this unit. When this unit is not connected to an environment under the control of the controller and Control4 SDDP from the Control4 Corporation, set this to "Off". |

Glossary of Network Terminology

- DHCP** : Abbreviation for Dynamic Host Configuration Protocol. This is a protocol for the network to assign an IP address automatically to the connected device.
- IP Address** : Numeric characters for identifying the device that is connected to the network.
- Subnet Mask** : Numeric characters that define the bit count used for the network address that is a segment of the IP address.
- Default Gateway** : Server for communicating beyond the network that is divided by the subnet mask.
- MAC Address** : Abbreviation for Media Access Control address. This is a number that is unique to each network adapter. Each of the network adapters is assigned with a unique MAC address.

Remote Code

For changing the remote control code.

| Setting | Description |
|---------|---|
| A | Change the remote control code from "B" to "A". |
| B | Change the remote control code from "A" to "B". |

- You need to configure the remote control according to the settings of this unit.
On the remote control unit, press the [MENU] and [BACK] buttons at the same time for three seconds or longer to switch the code.
 - The backlight of the remote control blinks 3 times: change the remote control code to "A"
 - The backlight of the remote control blinks 2 times: change the remote control code to "B"
- If the setting differs between this unit and the remote control, the "STANDBY/ON" indicator blinks in green when receiving the remote control code.



Hide Mode

For reducing the power consumption through suppressing the current supply for the LD block when the [HIDE] button is pressed to hide the image temporarily.

| Setting | Description |
|---------|---|
| Off | Do not suppress the current supply when the [HIDE] button is pressed to hide the image temporarily. |
| On | Suppresses the current supply when the [HIDE] button is pressed to hide the image temporarily. |

Factory Reset

For restoring the settings of this unit to the factory default. However, the following settings will not be reset.

- Gamma data saved in “Gamma” → “Correction Value” → “Import”.
- Color profile data saved in “Color Profile” → “Custom1 to Custom6”.

Software Update

For performing a software update.

For the latest information on the software, refer to <http://www3.jvckenwood.com/english/download/>.

Information

| Setting | Description |
|---|---|
| Input | Displays the currently selected video input terminal. |
| Source (Displayed only during video signal input) | Displays the input source. |
| Resolution (Displayed only during PC signal input) | Displays the image resolution. |
| H Frequency | Displays the horizontal frequency. |
| V Frequency | Displays the vertical frequency. |
| Color Depth | Displays the color space and color bit depth of the input video signal. |
| Color Space | <ul style="list-style-type: none">• The color bit depth is not displayed when YCbCr (4:2:2) is input.• The color bit depth is displayed when color bit depth information is received from the source device. |
| Colorimetry | Displays the Colorimetry of the input signal. |
| HDR | Displays the EOTF information when HDR packet is received. |
| Max CLL / Max FALL *v1.24 ~ | Displays the mastering information of the contents during HDR playback. Max CLL: Maximum Content Light Level Max FALL: Maximum Frame Average Light Level <ul style="list-style-type: none">• The information may not be displayed depending on the player and contents. |
| Light Source Time | Displays the used hours for the LD block. |
| Soft Ver. | Displays the firmware version. |

Maintaining the Cabinet and Remote Control

- Gently wipe off dirt on the cabinet with a soft cloth.
- If it is extremely dirty, wet a cloth in water, wring dry and use it to wipe off the dirt, followed by wiping again with a dry cloth.
- Pay attention to the following as the cabinet may deteriorate in condition or the paint may come off.
 - Do not wipe with thinner or benzine
 - Do not allow prolonged contact with rubber or plastic products
 - Do not spray volatile chemicals such as insecticide

Cleaning and Replacing the Filter

Clean the filter regularly. Using a filter without cleaning may reduce the brightness of the image. Dirt that enters the unit may also appear as shadows on the image.

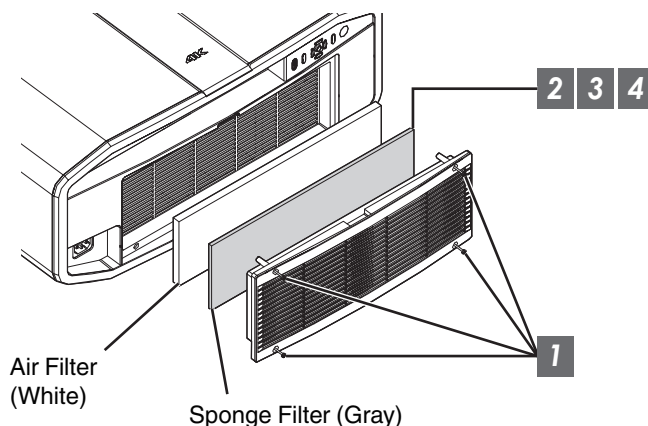

- 1** Loosen the 4 screws and remove the cover
 - The screws cannot be removed from the cover. Do not try to remove the screws from the cover by force.
- 2** Remove the sponge filter
- 3** Use a vacuum cleaner to remove dirt from the sponge filter carefully
- 4** Restore the sponge filter
- 5** Restore the cover and fasten the 4 screws

CAUTION

- Do not wash the air filter with water. Doing so may cause the filter to deteriorate.
- Make sure to attach the air filter and sponge filter in the correct sequence.

MEMO

- If the air filter or sponge filter is damaged and requires replacement, or if dust gets into the unit, consult your authorized dealer or nearby service center.
- Air filter
Product no.: F1K-0062-00
- Sponge filter
Product no.: J3K-0049-00

Troubleshooting

Before sending the unit to your authorized dealer for repair, please check the following points.

The following symptoms are not malfunctions.

You do not need to worry about the following symptoms if there is no abnormality on the screen.



- A part of the top or front surface of the unit is hot.
- A creaking sound is heard from the unit.
- An operating sound is heard from the inside of the unit.
- Color smear occurs on some screens.

This unit is a digital device. This unit may become unable to operate normally due to external static or noise. Perform the following operations when such malfunctions occur.

- ① If the unit is in the Standby mode, pull out the power plug, followed by inserting it again
- ② Press the  button on the projector unit to turn on the power again

When “High Altitude Mode” is set to “On”, and “LD Power” is set to “High” during 3D mode, the fan will make louder noise than usual since it is designed to run at high speed in 3D mode.

Power is not supplied

| Check | Action | Refer to |
|------------------------------------|--|----------|
| Is the power cord disconnected? | Insert the power cord (plug) firmly. | P. 23 |
| Is the unit in the Cool-down mode? | After exiting the Cool-down mode, turn on the power again. | P. 25 |
| Is the unit in the Eco mode? | Press the  button on the projector unit or the remote control unit. After the “STANDBY/ON” indicator lights up in red, press the  [ON] button. | P. 58 |

Power shuts down automatically

| Check | Action | Refer to |
|--|--|-----------|
| Has “ECO Mode” been configured? | Set “ECO Mode” to “Off”. | P. 58 |
| Has “Off Timer” been configured? | Set “Off Timer” to “Off”. | P. 58 |
| Are the air inlets and exhaust vent blocked? | Leave proper clearance when installing the unit. | P. 12, 17 |
| Is there a large amount of dirt attached to the sponge filter? | Remove the dirt using a vacuum cleaner. | P. 61 |

Video image does not appear

| Check | Action | Refer to |
|---|--|----------|
| Is the correct external input selected? | Select the correct external input terminal. | P. 24 |
| Is the power of the AV device or PC turned on? | Turn on the power of the AV device or PC and play the video. | P. 21 |
| Is the AV device or PC properly connected? | Connect the AV device or PC properly. | P. 21 |
| Are the correct signals being output from the AV device or PC? | Set the AV device or PC properly. | P. 21 |
| Is the cable in use an HDMI-certified cable? | Use an HDMI-certified high-speed cable. Please use a certified Premium High Speed HDMI Cable (18 Gbps compatible) when inputting 4K video signals. | P. 21 |
| Is an intermediate device (AV amplifier, divider, etc.) in use? | Change the sequence of turning on the source device, intermediate device and the projector. And after turning on each device, ensure that the signal output is stable before turning on the next device. | P. 21 |
| Is an old source device in use? | Change the resolution setting of the source device. For details on how to change the setting, please refer to the instruction manual of the source device. Or, try connecting to the HDMI 2 terminal and set "HDMI 2 EDID" to "B". | P. 49 |

3D images do not appear

| Check | Action | Refer to |
|---|--|--|
| Do you see two images displayed side by side? | Set "3D Format" to "Side by Side" Video images in the "Side by Side" format may not be recognized automatically in the case of 3D video images. | P. 30 |
| Is an intermediate device (AV amplifier, divider, etc.) in use? | Connect the source device to the projector directly, and check whether there is any improvement in the condition. If the condition improves, it is likely that this is not caused by malfunction of the projector. | P. 21 |
| Is the cable in use an HDMI-certified cable? | Use an HDMI-certified high-speed cable. Also, use as short a cable as possible. | P. 21 |
| Is the power of the 3D Glasses turned on? | If you are using the PK-AG2 or PK-AG3 3D Glasses, turn on the power manually. | Check the instruction manual of the 3D Glasses and 3D Synchro Emitter. |
| Are the 3D Glasses charged? | Check whether the PK-AG1 battery of the 3D Glasses has run out, and whether PK-AG2 and PK-AG3 are charged. | |
| Are the 3D Glasses and 3D Synchro Emitter too far away from each other? | Position them at an appropriate distance. | P. 10 |
| Is the 3D Glasses and 3D Synchro Emitter combination correct? | Check the model name of 3D Glasses and 3D Synchro Emitter, and use the correct combination. | |

3D video image looks unnatural

| Check | Action | Refer to |
|-------------------------------------|---|----------|
| Are there overlapping video images? | If there are overlapping video images partially, this is due to the crosstalk phenomenon. In this case, adjust "Crosstalk Cancel" accordingly. | P. 30 |
| | If there are overlapping video images partially, this is due to the crosstalk phenomenon. This phenomenon often occurs when there are drastic changes in the brightness. In this case, set "LD Power" to "High" | P. 44 |

Video image looks unnatural

Colors are unnatural

| Check | Action | Refer to |
|---|--|----------|
| Is the color space of the input signal correctly set? | The color may turn out unnatural when the input signal is different from that in the projector setting. Set the “Color Space” for “Input Signal” correctly. | P. 49 |
| Is the image correctly adjusted? | Adjust “Color” and “Tint” accordingly. | P. 48 |
| Is the AV device or PC properly connected? | Connect the AV device or PC properly. | P. 21 |

* The video image may appear slightly reddish immediately after starting up. This is not a malfunction.

Video image is fuzzy

| Check | Action | Refer to |
|--|---|----------|
| Is the focus correctly adjusted? | Adjust the focus. | P. 26 |
| Is the unit placed too near or too far away from the screen? | Set the unit at a correct distance from the screen. | P. 73 |

Video image flickers

| Check | Action | Refer to |
|---|--|----------|
| Do you see horizontally-extended, overlapping video images? | In this case, set “3D Format” to “Auto” | P. 30 |
| Are you viewing the video images under a fluorescent light? | This is caused by interference between the 3D glasses with the flickers of the fluorescent light. View with the fluorescent light turned off. | — |

Projected image is dark

| Check | Action | Refer to |
|-----------------------------|---|----------|
| Is the aperture closed? | Increase the value of the “Aperture” setting. | P. 44 |
| Is “LD Power” set to “Low”? | Set “LD Power” to “High” or “Mid”. | P. 44 |

Video image appears horizontally (vertically) extended

| Check | Action | Refer to |
|--|---------------------------|----------|
| Is “3D Format” set to “Side by Side”? | Set “3D Format” to “Auto” | P. 30 |
| Is “Anamorphic” set to a setting other than “Off”? | Set “Anamorphic” to “Off” | P. 56 |

Striped patterns appear on the screen

| Check | Action | Refer to |
|---|---|----------|
| Does the fabric of the screen have a regular pattern? | Interference fringes may sometimes occur between the fabric pattern and the pixels. Please consult the authorized dealer. | — |

Video images are missing

| Check | Action | Refer to |
|----------------------------------|----------------------|----------|
| Has screen mask been configured? | Set "Mask" to "Off". | P. 56 |

Remote control does not work

| Check | Action | Refer to |
|--|--|----------|
| Are the batteries correctly loaded? | Match the polarities (\oplus \ominus) correctly when loading the batteries. | P. 15 |
| Are the batteries exhausted? | Replace with new batteries. | P. 15 |
| Is there an obstructing object between the remote control and remote sensor? | Remove any obstructing object. | P. 15 |
| Is the remote control held too far away from the unit? | Hold the remote control closer to the sensor during use. | P. 15 |
| Are the IR (infrared) 3D Glasses and 3D Synchro Emitter in use? | As there is a possibility of signal interference, when you are using the IR (infrared) 3D Glasses together with the 3D Synchro Emitter, try adjusting the orientation of the 3D Synchro Emitter. | P. 29 |



Noise is heard

| Check | Action | Refer to |
|--|--|----------|
| Is the exhaust vent blocked? Is the unit used near a heater or air-conditioner? | Check the installation condition of the projector. When the surrounding temperature of the projector is high, the fan revolution speed increases to protect the projector unit, hence a louder operating sound. | P. 17 |
| Is "LD Power" set to "High"? | Setting "LD Power" to "High" increases the fan rotation speed, and noise would be louder as a result. | P. 44 |

There are small black or colored dots on the screen

The D-ILA device is manufactured using high-precision technologies, but there may be some (less than 0.01%) missing pixels or pixels that remain permanently lit. This is not a malfunction.

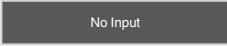
When the Following Messages Appear...

| Message | Description | Action |
|---|---|---|
|  | <ul style="list-style-type: none">• No device is connected to the input terminal.• The input terminal is connected but there is no signal. | Input the video signals. |
|  | A video signal that cannot be used with this unit has been input (The names of input terminals such as “HDMI 1” and “HDMI 2” will be displayed in yellow). | Input video signals that can be used. (P. 74) |

External Control

It is possible to control this unit by connecting it to a PC using an RS-232C cross cable (D-sub 9-pin). The projector can be controlled by connecting it to a PC through the computer network with a LAN cable for control commands to be sent to the projector.

➔ “ Network ” (P. 59)

- Please use it after you have gained proper understanding from professional books or consulting the system administrator.

RS-232C Specifications

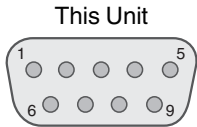

| Pin No. | Signal | Function | Signal Direction |
|-------------|--------|-------------------|------------------|
| 2 | RxD | Receive data | PC → This unit |
| 3 | TxD | Transmission data | This unit → PC |
| 5 | GND | Signal ground | — |
| 1, 4, 6 - 9 | N/C | — | — |

- PC refers to the controller, such as a personal computer.

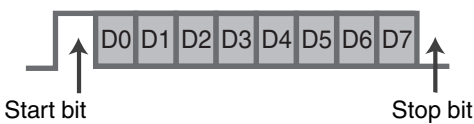

| Mode | Non-synchronous |
|------------------|-----------------|
| Character length | 8 bit |
| Parity | None |
| Start bit | 1 |
| Stop bit | 1 |
| Data rate | 19200 bps |
| Data format | Binary |

TCP/IP Connection

Before controlling via LAN, it is necessary to establish connection of the TCP layer by a “3-way handshake”, followed by sending out “PJREQ” and receiving “PJACK” within five seconds after the projector sends out “PJ_OK” for connection authentication.

If you are unable to complete sending within five seconds, or when “PJ_NG” or “PJNAK” is received, check the operating status of the projector, followed by performing the steps again starting from establishment of a TCP connection.

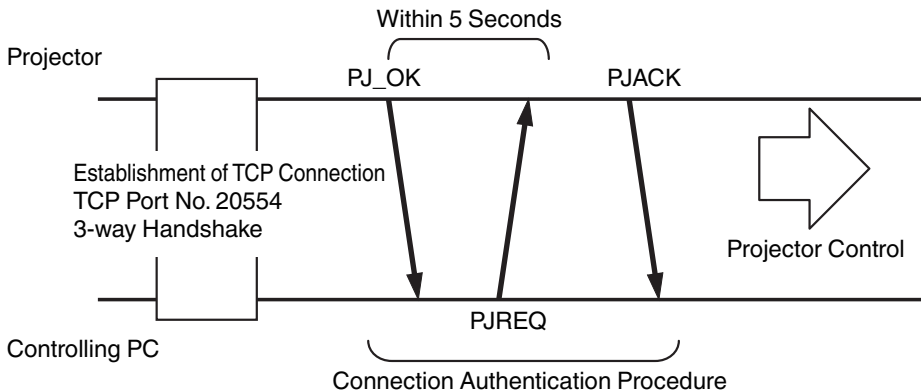

Command Format

The command between this unit and the computer consists of “Header”, “Unit ID”, “Command”, “Data” and “End”.

- Header (1 byte), Unit ID (2 bytes), Command (2 bytes), Data (n bytes), End (1 byte)

Header

This binary code indicates the start of communication.

| Binary Code | Type | Description |
|-------------|-------------------|--|
| 21 | Operating command | PC → This unit |
| 3F | Reference command | PC → This unit |
| 40 | Response command | This unit → PC |
| 06 | ACK | This unit → PC (returns to PC after the command is accepted without error) |

Unit ID

This is a code that specifies the unit. The binary code is fixed at “8901”.

Command and data

Operating command and data (binary code)

| Command | Type | Description |
|---------|------------------|---|
| 0000 | Connection check | Check whether communication is enabled between this unit and the PC during standby. |
| 5057 | Power supply | During standby 31: Turns on the power When power is on 30: Turns off the power (Standby mode) |
| 4950 | Input | When power is on 36: HDMI 1 37: HDMI 2 |
| 5243 | Remote control | Sends the same code as the supplied remote control. <ul style="list-style-type: none"> • “Remote Control Code”P. 69 |

Reference command and data (binary code)

| Command | Type | Description |
|---------|--------------|---|
| 5057 | Power supply | During standby or when power is on 30: Standby mode 31: When power is on 32: In the Cool-down mode 34: When error occurs on this unit |
| 4950 | Input | When power is on 36: HDMI 1 37: HDMI 2 |

End

This code indicates the end of communication. The binary code is fixed at “0A”.

Remote Control Code

Binary code is sent during communication.

- The following applies to the case when the remote control code is "A". In the case of "B", add "36" to the beginning of the code.

| Remote Control Button Name | Binary Code |
|----------------------------|-------------|
| STAND BY | 37 33 30 36 |
| ON | 37 33 30 35 |
| HDMI 1 | 37 33 37 30 |
| HDMI 2 | 37 33 37 31 |
| INFO. | 37 33 37 34 |
| MODE 1 | 37 33 44 38 |
| MODE 2 | 37 33 44 39 |
| MODE 3 | 37 33 44 41 |
| LENS CONTROL | 37 33 33 30 |
| LENS AP. | 37 33 32 30 |
| ANAMO. | 37 33 43 35 |
| HIDE | 37 33 31 44 |
| ▲ | 37 33 30 31 |
| ▼ | 37 33 30 32 |
| ▶ | 37 33 33 34 |
| ◀ | 37 33 33 36 |

| Remote Control Button Name | Binary Code |
|----------------------------|-------------|
| OK | 37 33 32 46 |
| MENU | 37 33 32 45 |
| BACK | 37 33 30 33 |
| NATURAL | 37 33 36 41 |
| CINEMA | 37 33 36 38 |
| HDR | 37 33 45 44 |
| PICTURE MODE | 37 33 46 34 |
| COLOR PROFILE | 37 33 38 38 |
| GAMMA SETTINGS | 37 33 46 35 |
| MPC | 37 33 46 30 |
| C.M.D. | 37 33 38 41 |
| ADVANCED MENU | 37 33 37 33 |
| GAMMA | 37 33 37 35 |
| COLOR TEMP. | 37 33 37 36 |
| 3D FORMAT | 37 33 44 36 |
| PIC. ADJ. | 37 33 37 32 |

Communications Example

This section shows the communication examples of RS-232C.

Operating command

| Type | Command | Description |
|-----------------------|--|--|
| Connection check | PC → This unit: 21 89 01 00 00 0A This unit → PC: 06 89 01 00 00 0A | Connection check |
| Power (On) | PC → This unit: 21 89 01 50 57 31 0A This unit → PC: 06 89 01 50 57 0A | When power is turned on from the Standby mode |
| Power (Off) | PC → This unit: 21 89 01 50 57 30 0A This unit → PC: 06 89 01 50 57 0A | When power is turned off (Standby mode) from power-on mode |
| Remote control (MENU) | PC → This unit: 21 89 01 52 43 37 33 32 45 0A This unit → PC: 06 89 01 52 43 0A | When the same operation as pressing the [MENU] button on the remote control is performed |

Reference command

| Type | Command | Description |
|----------------|--|--|
| Power (On) | PC → This unit: 3F 89 01 50 57 0A This unit → PC: 06 89 01 50 57 0A This unit → PC: 40 89 01 50 57 31 0A | When information on the power-on state is acquired |
| Input (HDMI 1) | PC → This unit: 3F 89 01 49 50 0A This unit → PC: 06 89 01 49 50 0A This unit → PC: 40 89 01 49 50 36 0A | When information on HDMI 1 input is acquired |

Specifications

| | | |
|-------------------------------------|------------------|--|
| Product Name | | D-ILA Projector |
| Model Name | | DLA-Z1 |
| Display Panel/Size | | D-ILA device *1, 2 0.69" 4K D-ILA (4096 x 2160 pixels) x 3 |
| Projection Lens | | 2.0 x power zoom lens (1.4:1 to 2.8:1), motorized zoom and focus |
| Light Source | | BLU-Escent (Laser Diode) |
| Screen Size | | Approx. 60" to 280" (Aspect ratio of 16:9) |
| Brightness | | 3000 lm |
| Projection Distance | | Refer to P. 73. |
| Input Compatibility Signal | | Refer to P. 74. |
| Display Resolution | | 4096 x 2160 pixels |
| Input Terminal | HDMI Input | Dual, HDMI 19-pin x 2 (HDCP 2.2-compatible) *3 |
| Output Terminal | Trigger Terminal | Single, Ø 3.5 mm DC Power Jack (⊖ ⊕) DC OUT 12 V, 0.1 A |
| | 3D synchro | Dedicated terminal for 3D Synchro Emitter (single, mini-DIN 3-pin) |
| Control Terminal | RS-232C Terminal | Single, D-sub 9-pin (male) (external control) |
| | LAN Terminal | Single, RJ45 jack, 10BASE-T/100BASE-TX |
| Service Terminal | SERVICE | Single (USB Type A) *4 |
| Power Requirements | | AC 100 V to 240 V, 50 Hz/60 Hz |
| Power Consumption | | 750 W (during normal standby: 1.5 W *5, during Eco Mode standby: 0.4 W *6) |
| Operation Environment | | Temperature: 5°C to 35°C; humidity: 20% to 80%; storage temperature: -10°C to 60°C |
| Installation Height | | Below 6,561 ft (2,000 m) |
| Dimensions (Width x Height x Depth) | | 500 mm x 235 mm x 720 mm (including feet) |
| Mass | | 37.5 kg |
| Accessories | | Refer to P. 10. |

*1 D-ILA is the abbreviation for Direct Drive Image Light Amplifier.

*2 D-ILA devices are manufactured using extremely high-precision technology with a pixel effectiveness of 99.99%. Only 0.01% or less of the pixels are either missing or would remain permanently lit.

*3 HDCP is the abbreviation for High-bandwidth Digital Content Protection system. The image of the HDMI input terminal may not be displayed in some cases due to changes in the HDCP specifications.

*4 Exclusively for firmware update.

*5 The power consumption of this product during networked standby when all wired network ports are connected is 1.5 W.

*6 "During standby" refers to Eco Mode standby (P. 58).

- Design and specifications are subject to change without prior notice.
- Please note that some of the pictures and illustrations may have been abridged, enlarged or contextualized in order to aid comprehension. Images may differ from the actual product.



This unit has obtained the “THX 4K DISPLAY Certification” determined by THX Ltd. In addition to 2K content, you can also enjoy faithful reproduction of images in a quality as intended by the filmmaker during playback of 4K content.

The THX 4K DISPLAY certification is “an indication of high definition and high resolution”, which is granted to products that have cleared more than 400 image quality tests.



This unit is isf-certified, so calibration can be performed by an isf-certified trainer. After calibration is performed, an isf mode is added to the Picture mode.

For more details, please refer to the isf website.
<http://www.imagingscience.com/>

About Trademarks and Copyrights



The terms HDMI and HDMI High-Definition Multimedia Interface, and the HDMI Logo are trademarks or registered trademarks of HDMI Licensing Administrator, Inc. in the United States and other countries.

Screen Size and Projection Distance

| Screen Size Diagonal (Inch) | Projection Distance (m) | | | | | | | |
|--------------------------------|-------------------------|----------|-------------|----------|---------------|----------|------------|----------|
| | 17:9 Screen | | 16:9 Screen | | 2.35:1 Screen | | 4:3 Screen | |
| | Wide-end | Tele-end | Wide-end | Tele-end | Wide-end | Tele-end | Wide-end | Tele-end |
| 60 | 1.66 | 3.43 | 1.75 | 3.61 | 1.86 | 3.82 | 2.16 | 4.44 |
| 70 | 1.96 | 4.02 | 2.06 | 4.23 | 2.18 | 4.47 | 2.54 | 5.19 |
| 80 | 2.25 | 4.60 | 2.37 | 4.84 | 2.50 | 5.12 | 2.91 | 5.94 |
| 90 | 2.54 | 5.19 | 2.67 | 5.46 | 2.83 | 5.77 | 3.29 | 6.70 |
| 100 | 2.83 | 5.77 | 2.98 | 6.07 | 3.15 | 6.41 | 3.66 | 7.45 |
| 110 | 3.12 | 6.36 | 3.28 | 6.69 | 3.47 | 7.06 | 4.04 | 8.20 |
| 120 | 3.41 | 6.94 | 3.59 | 7.30 | 3.79 | 7.71 | 4.41 | 8.95 |
| 130 | 3.70 | 7.53 | 3.90 | 7.92 | 4.12 | 8.36 | 4.79 | 9.71 |
| 140 | 3.99 | 8.11 | 4.20 | 8.53 | 4.44 | 9.01 | 5.16 | 10.46 |
| 150 | 4.28 | 8.70 | 4.51 | 9.15 | 4.76 | 9.66 | 5.53 | 11.21 |
| 160 | 4.58 | 9.28 | 4.81 | 9.76 | 5.09 | 10.31 | 5.91 | 11.96 |
| 170 | 4.87 | 9.87 | 5.12 | 10.38 | 5.41 | 10.96 | 6.28 | 12.72 |
| 180 | 5.16 | 10.45 | 5.43 | 10.99 | 5.73 | 11.61 | 6.66 | 13.47 |
| 190 | 5.45 | 11.04 | 5.73 | 11.61 | 6.05 | 12.26 | 7.03 | 14.22 |
| 200 | 5.74 | 11.62 | 6.04 | 12.22 | 6.38 | 12.91 | 7.41 | 14.98 |
| 210 | 6.03 | 12.21 | 6.34 | 12.84 | 6.70 | 13.56 | 7.78 | 15.73 |
| 220 | 6.32 | 12.79 | 6.65 | 13.45 | 7.02 | 14.21 | 8.16 | 16.48 |
| 230 | 6.61 | 13.38 | 6.95 | 14.07 | 7.35 | 14.85 | 8.53 | 17.23 |
| 240 | 6.90 | 13.96 | 7.26 | 14.68 | 7.67 | 15.50 | - | - |
| 250 | 7.19 | 14.55 | 7.57 | 15.30 | 7.99 | 16.15 | - | - |
| 260 | 7.49 | 15.13 | 7.87 | 15.91 | 8.32 | 16.80 | - | - |
| 270 | 7.78 | 15.72 | 8.18 | 16.53 | 8.64 | 17.45 | - | - |
| 280 | 8.07 | 16.31 | 8.48 | 17.14 | - | - | - | - |
| 290 | 8.36 | 16.89 | - | - | - | - | - | - |
| 300 | 8.65 | 17.48 | - | - | - | - | - | - |

Types of Possible Input Signals

Video

| | | |
|----------------------|----------------|--|
| Digital Video Signal | | 480p 576p 720p 50/60 Hz 1080i 50/60 Hz 1080p 24/25/30/50/60 Hz 2K (2048×1080) 24/25/30/50/60 Hz 4K (3840×2160) 24/25/30/50*/60* Hz 4K (4096×2160) 24/25/30/50*/60* Hz |
| 3D Signal | Frame Packing | 720p 50/60 Hz 1080p 24 Hz |
| | Side-by-side | 720p 50/60 Hz 1080p 50/60/24 Hz 1080i 50/60 Hz |
| | Top-and-bottom | 720p 50/60 Hz 1080p 24 Hz |

* When the color space is RGB/YCbCr(4:4:4), only 8-bit input is supported.

PC signal (HDMI)

| Designation | Resolution | fh [kHz] | fv [Hz] | dot CLK [MHz] | Total No. of Dots [dot] | Total No. of Lines [line] | No. of Effective Dots [dot] | No. of Effective Lines [line] |
|-------------|------------|----------|---------|---------------|-------------------------|---------------------------|-----------------------------|-------------------------------|
| VGA | 640×480 | 31.469 | 59.940 | 25.175 | 800 | 525 | 640 | 480 |
| SVGA | 800×600 | 37.879 | 60.317 | 40.000 | 1056 | 628 | 800 | 600 |
| XGA | 1024×768 | 48.363 | 60.004 | 65.000 | 1344 | 806 | 1024 | 768 |
| WXGA | 1280×768 | 47.776 | 59.870 | 79.500 | 1664 | 798 | 1280 | 768 |
| WXGA | 1280×800 | 49.702 | 59.810 | 83.500 | 1680 | 831 | 1280 | 800 |
| FWXGA | 1366×768 | 47.712 | 59.790 | 85.500 | 1792 | 798 | 1366 | 768 |
| WXGA+ | 1440×900 | 55.935 | 59.887 | 106.500 | 1904 | 934 | 1440 | 900 |
| SXGA | 1280×1024 | 63.981 | 60.020 | 108.000 | 1688 | 1066 | 1280 | 1024 |
| WXGA++ | 1600×900 | 60.000 | 60.000 | 108.000 | 1800 | 1000 | 1600 | 900 |
| WSXGA+ | 1680×1050 | 65.290 | 59.954 | 146.250 | 2240 | 1089 | 1680 | 1050 |
| UXGA | 1600×1200 | 75.000 | 60.000 | 162.000 | 2160 | 1250 | 1600 | 1200 |
| WUXGA | 1920×1200 | 74.556 | 59.885 | 193.250 | 2592 | 1245 | 1920 | 1200 |

* Even when signals can be input, video images may not be projected properly depending on the PC or cable in use. When this occurs, switching to another compatible resolution or changing the cable may help to resolve the problem in some cases.

Indicator Display on the Main Unit

Meaning of the front panel indicators



The indicator lights up.



The indicator appears blinking.

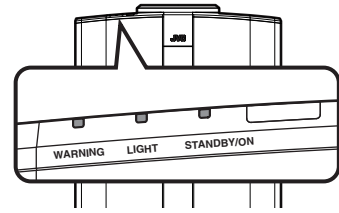

Operation mode display

Displays using the different colors and solid/blinking light of the indicator on the projector unit.

“STANDBY/ON” lights up (red)

- In standby state



“STANDBY/ON” blinking (red)

- In the Cool-down mode



“STANDBY/ON” lights up (green)

- When LD block is starting up



“STANDBY/ON” blinking (green)

- When the video image is temporarily hidden (HIDE is on)



All lights off

- During projection
- When in “ECO Mode”





Warning display

You can tell the details of a warning from the (repeated) displays of the “WARNING” and “LIGHT” indicators. The “STANDBY/ON” indicator will light up or appear blinking according to the operation mode of the projector unit. (Please refer to ““Operation mode display”P. 75”.)

The Warning mode is activated once the message is displayed. Projection is interrupted, and the cooling fan is turned on for about 10 seconds.

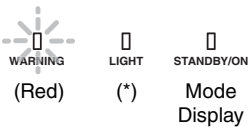
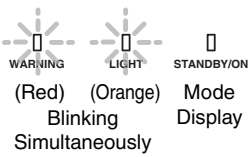
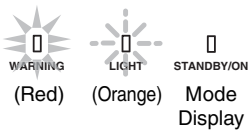
The power cannot be turned on again while cooling is in progress. Check the following after cooling is complete.

| Indicator Status | Blinking Frequency | Description | Check and Countermeasure |
|---|--------------------|--|--|
|  | x2 | Cooling fan stopped abnormally | <ul style="list-style-type: none"> • Check that nothing is blocking the air inlets. • Check that the external temperature is normal. Countermeasure: Leave the unit unoperated until it cools down. After that, turn on the power again. |
| | x3 | Internal temperature is abnormally high | |
| | x4 | External temperature is too high | |
|  | x1 | Abnormal circuit operation | |
| | x2 | | |
| | x3 | | |
| | x4 | | |
|  | x1 | When the safety switch is activated | Request for repair at your authorized dealer or a nearby service center. |
| | x3 | | |
| | x4 | | |
|  | x3 | The remote control code differs between this unit and the remote control | Set the remote control code for this unit and the remote control correctly.(P. 59) |

If the Warning mode is activated again, wait for the cooling fan to stop, followed by pulling out the power plug from the outlet.

Request for repair at your authorized dealer or a nearby service center.

Dimensions

(Unit: mm)

Top Surface

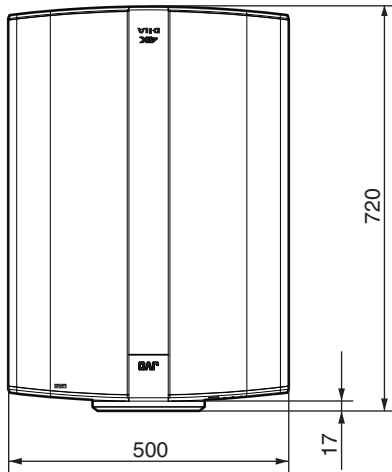

Bottom Surface

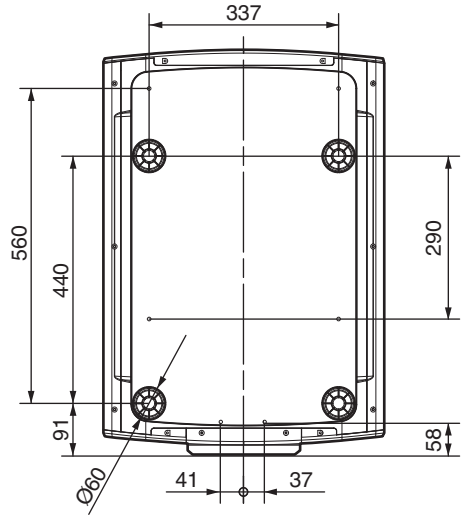

Front

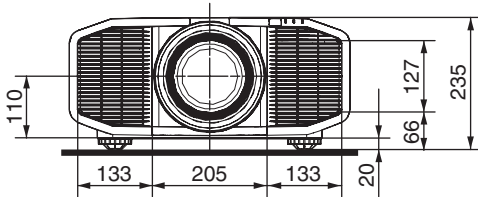

Rear Surface

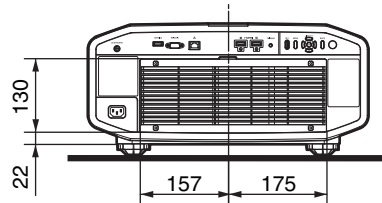

Index

| | | | | | |
|----------|---|--------|--|---|----|
| A | Accessories | 10 | Input terminals | 13 | |
| | Adjusting Distortion of the Projection Screen | 26 | Installation Method | 17 | |
| | Adjustment and Setting by the Menu | 42 | Installing the 3D Syncro Emitter | 29 | |
| | Adjustment of the Image Quality | 44 | | | |
| | ADVANCED MENU | 14 | K | Keystone Correction | 56 |
| | Anamorphic | 56 | | | |
| | Aperture | 44 | L | Language Selection | 57 |
| | Aspect | 28 | | Lens | 11 |
| B | Back Color | 57 | | LENS AP | 14 |
| | Brightness | 48 | | Lens Control | 26 |
| | | | | Lens Cover | 10 |
| C | Ceiling Mount | 19 | | Lens Memory | 26 |
| | Cleaning and Replacing the Filter | 61 | | Lens Shift | 26 |
| | Clear Black | 44 | | Line Display | 57 |
| | Clear Motion Drive | 40 | | Logo Display | 57 |
| | Clear Motion Drive | 40 | | | |
| | Color Density | 48 | M | Menu Items | 42 |
| | Color Management | 34 | | Menu Position | 57 |
| | COLOR P.FILE | 32 | | MPC LEVEL | 35 |
| | Color Profile | 32 | | | |
| | Color Shade | 48 | N | Network | 59 |
| | Color Space | 49 | | NR | 48 |
| | Color Temperature | 45 | | | |
| | Connection | 21 | O | Off Timer | 58 |
| | Contrast | 48 | | Optional Accessories | 10 |
| | Controls and Features | 11 | | | |
| | Custom Gamma | 38 | P | PIC. ADJ. | 48 |
| D | Dimensions | 77 | | Picture Mode | 31 |
| | Distortion Correction | 57 | | Picture Tone | 47 |
| | | | | Pixel Adjustment | 52 |
| E | Eco Mode | 58 | | Precautions during Installation | 17 |
| | External Control | 67 | | Projection Distance | 73 |
| | | | | | |
| F | Filter Product no. | 61 | R | Remote Control | 14 |
| | Focus | 26 | | RGB | 49 |
| | Frame Packing | 30 | | RS-232C | 22 |
| | | | | | |
| G | GAMMA | 36 | S | Screen Correction | 27 |
| | Gamma Adjustment | 36 | | Screen Mask | 56 |
| | | | | Screen Size and Projection Distance | 73 |
| H | HDMI Color Space | 49 | | Shadow/Highlight Correction | 38 |
| | HDMI Input Level | 49 | | Shift | 26 |
| | HDMI Input Terminal | 21 | | Side by Side | 30 |
| | HIDE | 24 | | Signal Display | 60 |
| | High Altitude Mode | 57 | | Software Ver. | 60 |
| | | | | Specifications | 71 |
| I | Indicator Display | 75 | T | THX | 72 |
| | INFO. | 14 | | Top and Bottom | 30 |
| | Input Resolution | 60, 74 | | Trigger | 58 |
| | Input Signal | 60, 74 | | Troubleshooting | 62 |

| | | |
|----------|--|----|
| U | User Name Edit | 44 |
| V | Viewing 3D Movies | 29 |
| | Viewing Videos | 24 |
| W | When the following messages appear... .. | 66 |
| Z | Zoom | 26 |

| | |
|---------------------------|--------|
| Alphanumeric | |
| 3D Crosstalk Cancel | 30 |
| 3D Format | 30 |
| 3D Glasses | 10, 29 |
| 3D Setting | 49 |
| 3D Synchro Emitter | 10, 29 |

JVC