

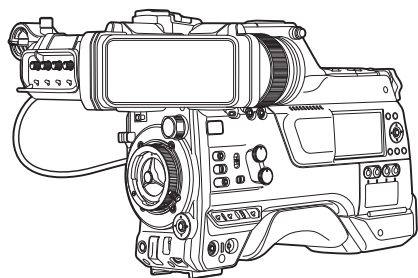

HD MEMORY CARD CAMERA RECORDER

GY-HC900CHU/GY-HC900CHE GY-HC900STU/GY-HC900RCHE

INSTRUCTIONS



CONNECTED CAM™

In this illustration, the supplied viewfinder is attached to the GY-HC900CHU/GY-HC900CHE. Wireless LAN antenna and viewfinder are not included in GY-HC900STU and GY-HC900RCHE. The specifications and appearance of this product are subject to changes for further improvement without prior notice.

Please check the latest version of the INSTRUCTIONS from the following Mobile User Guide. You can also download the PDF from the Mobile User Guide.

Mobile User Guide

When you are outside, you can refer to the instructions from your Android phone or iPhone.

<http://manual3.jvckenwood.com/pro/mobile/global/>

You can view the Mobile User Guide using the browser on your Android phone or iPhone.



For Customer Use:

Enter below the Serial No. which is located on the body.
Retain this information for future reference.

Model No. GY-HC900CHU/GY-HC900STU
Serial No. _____

Please read the following before getting started:

Thank you for purchasing this product. Before operating this unit, please read the instructions carefully to ensure the best possible performance.

In this manual, each model number is described without the last letter (U/E) which means the shipping destination.

(U: for USA and Canada, E: for Europe)

Only "U" models (GY-HC900CHU/GY-HC900STU) have been evaluated by UL.

FOR USA

These are general Important Safety Instructions and certain items may not apply to all appliances.

Important Safety Instructions

1. Read these instructions.
2. Keep these instructions.
3. Heed all warnings.
4. Follow all instructions.
5. Do not use this apparatus near water.
6. Clean only with dry cloth.
7. Do not block any ventilation openings. Install in accordance with the manufacturer's instructions.
8. Do not install near any heat sources such as radiators, heat registers, stoves, or other apparatus (including amplifiers) that produce heat.
9. Protect the power cord from being walked on or pinched particularly at plugs, convenience receptacles, and the point where they exit from the apparatus.
10. Only use attachments/accessories specified by the manufacturer.
11. Use only with the cart, stand, tripod, bracket, or table specified by the manufacturer, or sold with the apparatus.
When a cart is used, use caution when moving the cart/apparatus combination to avoid injury from tip-over.
12. Unplug this apparatus during lightning storms or when unused for long periods of time.
13. Refer all servicing to qualified service personnel.
Servicing is required when the apparatus has been damaged in any way, such as power-supply cord or plug is damaged, liquid has been spilled or objects have fallen into the apparatus, the apparatus has been exposed to rain or moisture, does not operate normally, or has been dropped.

**For USA-California Only**

This product contains a CR Coin Cell Lithium Battery which contains Perchlorate Material – special handling may apply.

See www.dtsc.ca.gov/hazardouswaste/perchlorate

POUR LES ÉTATS-UNIS

Ces informations sont des **CONSIGNES DE SÉCURITÉ IMPORTANTES** et certains points peuvent ne pas s'appliquer à tous les appareils.

CONSIGNES DE SÉCURITÉ IMPORTANTES

1. Lire ces instructions.
2. Conserver ces instructions.
3. Tenir compte de tous les avertissements.
4. Respecter toutes les instructions.
5. Ne pas utiliser cet appareil à proximité de l'eau.
6. Ne nettoyer qu'avec un chiffon sec.
7. Ne pas boucher les ouvertures de ventilation.
Installer selon les instructions du fabricant.
8. Ne pas installer à proximité de sources de chaleur telles que des radiateurs, des accumulateurs de chaleur, des poêles, ou d'autres appareils (comprenant les amplificateurs) qui produisent de la chaleur.
9. Protéger le cordon d'alimentation pour éviter qu'il ne soit piétiné ou ne se coince, tout particulièrement au niveau de la fiche, de la prise de courant et du point où il sort de l'appareil.
10. Utiliser uniquement des équipements/accessoires spécifiés par le fabricant.
11. N'utiliser qu'avec le chariot, le stand, le trépied, le support ou la table spécifié par le fabricant, ou vendu avec l'appareil.
Lorsqu'un chariot est utilisé, faire attention pour déplacer la combinaison chariot/appareil pour éviter des blessures causées par un basculement.
12. Débrancher cet appareil pendant un orage ou quand il n'est pas utilisé pendant une longue durée.
13. L'entretien ou la réparation de l'appareil doit être effectué par du personnel qualifié uniquement.
Un dépannage est nécessaire lorsque l'appareil a été endommagé d'une façon ou d'une autre, telle que lorsque le cordon d'alimentation ou la fiche est endommagé, si du liquide a été renversé ou si des objets sont tombés à l'intérieur de l'appareil, si l'appareil a été exposé à la pluie ou à l'humidité, ne fonctionne pas normalement ou a fait une chute.



Pour Californie des États-Unis seulement

Cet appareil contient une pile-bouton CR au lithium qui contient du perchlorate – une manipulation spéciale peut être requise.

Voir www.dtsc.ca.gov/hazardouswaste/perchlorate

Safety Precautions

FOR USA AND CANADA



CAUTION

RISK OF ELECTRIC SHOCK
DO NOT OPEN



CAUTION:

TO REDUCE THE RISK OF ELECTRIC SHOCK. DO NOT REMOVE COVER (OR BACK). NO USER-SERVICEABLE PARTS INSIDE. REFER SERVICING TO QUALIFIED SERVICE PERSONNEL.



The lightning flash with arrowhead symbol, within an equilateral triangle is intended to alert the user to the presence of uninsulated “dangerous voltage” within the product’s enclosure that may be of sufficient magnitude to constitute a risk of electric shock to persons.



The exclamation point within an equilateral triangle is intended to alert the user to the presence of important operating and maintenance (servicing) instructions in the literature accompanying the appliance.

POUR CANADA



ATTENTION

RISQUE D'ELECTROCUTION
NE PAS OUVRIR



ATTENTION:
POUR EVITER TOUT RISQUE D'ELECTROCUTION NE PAS OUVRIR LE BOITIER. AUCUNE PIECE INTERIEURE N'EST A REGLER PAR L'UTILISATEUR. SE REFERER A UN AGENT QUALIFIE EN CAS DE PROBLEME.



Le symbole de l'éclair à l'intérieur d'un triangle équilatéral est destiné à alerter l'utilisateur sur la présence d'une “tension dangereuse” non isolée dans le boîtier du produit. Cette tension est suffisante pour provoquer l'électrocution de personnes.



Le point d'exclamation à l'intérieur d'un triangle équilatéral est destiné à alerter l'utilisateur sur la présence d'opérations d'entretien importantes au sujet desquelles des renseignements se trouvent dans le manuel d'instructions.

Ces symboles ne sont utilisés qu'aux Etats-Unis.

Supplier's Declaration of Conformity

Model Number: GY-HC900CHU
 GY-HC900STU
 Trade Name: JVC
 Responsible Party: JVCKENWOOD USA Corporation
 Address: 500 Valley Road,
 Suite 203 Wayne,
 NJ 07470
 Telephone Number: 973-317-5000

This device complies with Part 15 of FCC Rules. Operation is subject to the following two conditions: (1) This device may not cause harmful interference, and (2) this device must accept any interference received, including interference that may cause undesired operation.

Changes or modifications not approved by JVC could void the user's authority to operate the equipment. This equipment has been tested and found to comply with the limits for a Class A digital device, pursuant to Part 15 of the FCC Rules. These limits are designed to provide reasonable protection against harmful interference when the equipment is operated in a commercial environment.

This equipment generates, uses, and can radiate radio frequency energy and, if not installed and used in accordance with the instructions, may cause harmful interference to radio communications. Operation of this equipment in a residential area is likely to cause harmful interference in which case the user will be required to correct the interference at his own expense.

Déclaration de conformité du fournisseur

Numéro de modèle : GY-HC900CHU
 GY-HC900STU
 Nom de marque : JVC
 Personne responsable : JVCKENWOOD USA Corporation
 Adresse : 500 Valley Road,
 Suite 203 Wayne,
 NJ 07470
 Numéro de téléphone : 973-317-5000

Cet ensemble se conforme à la partie 15 des règles de la FCC (Federal Communications Commission). Le fonctionnement est sujet aux deux conditions suivantes : (1) Cet appareil ne peut pas causer d'interférences nuisibles, et (2) cet appareil doit accepter toute interférence reçue, comprenant des interférences qui peuvent causer un mauvais fonctionnement.

Des changements ou modifications non approuvés par JVC peuvent annuler le droit de l'utilisateur de faire fonctionner l'appareil. Cet appareil a été testé et il a été reconnu qu'il se conforme aux limites concernant l'appareillage informatique de classe A correspondant à la partie 15 des règles de la FCC. Ces limites sont conçues pour fournir une protection raisonnable contre les interférences dangereuses lorsque l'équipement est utilisé dans un environnement commercial.

Cet appareil génère, utilise et peut émettre de l'énergie des fréquences radio et, s'il n'est pas installé et utilisé selon les instructions du fabricant, peut causer des interférences nuisibles en communications radio. L'utilisation de cet équipement dans une zone résidentielle est susceptible de causer des interférences néfastes, auquel cas l'utilisateur devra prendre des mesures à ses propres frais.

CAUTION:

The mains plug shall remain readily operable.

- Remove the mains plug immediately if the camera functions abnormally.

WARNING:

The battery pack, the camera with battery installed, and the remote control with battery installed should not be exposed to excessive heat such as direct sunlight, fire or the like.

WARNING: TO PREVENT FIRE OR SHOCK HAZARD, DO NOT EXPOSE THIS UNIT TO RAIN OR MOISTURE.

NOTES:

- The rating plate and safety caution are on the bottom and/or the back of the main unit.
- The serial number plate is on the bottom of the unit.

Caution on Replaceable lithium battery

The battery used in this device may present a fire or chemical burn hazard if mistreated.

Do not recharge, disassemble, heat above 100°C (212°F) or incinerate. Replace battery with Panasonic, Sanyo, Sony or Maxell CR2025.

Danger of explosion or risk of fire if the battery is incorrectly replaced.

- Dispose of used battery promptly.
- Keep away from children.
- Do not disassemble and do not dispose of in fire.

Attention:

La prise secteur doit être opérationnelle.

- Débranchez immédiatement la fiche secteur si le caméscope ne fonctionne pas normalement.

Avertissement:

Évitez d'exposer la batterie, le caméscope avec la batterie insérée ou la télécommande avec la batterie insérée à une chaleur excessive, telle que celle des rayons directs du soleil, d'un feu ou de tout autre source de chaleur.

AVERTISSEMENT : POUR EVITER LES RISQUES D'INCENDIE OU D'ELECTROCUTION, NE PAS EXPOSER L'APPAREIL A LA PLUIE NI A L'HUMIDITE.

REMARQUES :

- La plaque d'identification et l'avertissement de sécurité se trouvent sous l'appareil et/ou au dos.
- La plaque du numéro de série est située sur la partie inférieure de l'appareil.

Avertissement sur la pile au lithium remplaçable

La pile utilisée dans cet appareil peut présenter des risques d'incendie ou de brûlure chimique si elle est mal traitée. Ne pas recharger, démonter, chauffer à plus de 100°C (212°F) ni mettre au feu. Remplacez la pile avec Panasonic, Sanyo, Sony ou Maxell CR2025.

Danger d'explosion ou risque d'incendie si la pile n'est pas changée correctement.

- Jeter immédiatement les piles usées.
- Placer hors de la portée des enfants.
- Ne pas démonter ni jeter au feu.

When the equipment is installed in a cabinet or on a shelf, make sure that it has sufficient space on all sides to allow for ventilation (10 cm (3-15/16") or more on both sides, on top and at the rear). Do not block the ventilation holes. (If the ventilation holes are blocked by a newspaper, or cloth etc. the heat may not be able to get out.) No naked flame sources, such as lighted candles, should be placed on the apparatus. When discarding batteries, environmental problems must be considered and the local rules or laws governing the disposal of these batteries must be followed strictly.

The apparatus shall not be exposed to dripping or splashing and that no objects filled with liquids, such as vases, shall be placed on the apparatus.

Do not point the lens directly into the sun. This can cause eye injuries, as well as lead to the malfunctioning of internal circuitry. There is also a risk of fire or electric shock.

CAUTION!

The following notes concern possible physical damage to this unit and to the user.

Carrying or holding this unit by the LCD monitor can result in dropping the unit, or in a malfunction.

Do not use a tripod on unsteady or unlevel surfaces. It could tip over, causing serious damage to the unit.

CAUTION!

Connecting cables (Audio/Video, etc.) to this unit and leaving it on top of the TV is not recommended, as tripping on the cables will cause the unit to fall, resulting in damage.

Si le matériel est installé dans un coffret ou sur une étagère, s'assurer qu'il y a un espace suffisant sur tous les côtés pour permettre la ventilation (10 cm (3-15/16") ou plus sur les deux côtés, au dessus et à l'arrière).

Ne pas boucher les orifices de ventilation.

(Si les orifices de ventilation sont bouchés par un journal, un tissu, etc., la chaleur peut ne pas s'éliminer.)

Aucune source à flamme nue, telle que des bougies allumées, ne doit être placée sur l'appareil.

En jetant des batteries aux ordures, les problèmes d'environnement doivent être pris en considération et les réglementations locales ou la législation concernant le rebut de ces batteries doivent être strictement respectées.

L'appareil ne doit pas être exposé à de l'eau ou à des éclaboussures et les objets remplis de liquide, tels que des vases, ne doivent pas être placés sur l'appareil.

Ne dirigez pas l'objectif directement vers le soleil. Vous pourriez vous abîmer la vue et l'appareil pourrait être endommagé. Il y a aussi risque d'incendie ou d'électrocution.

Attention!

Les remarques suivantes sont destinées à protéger l'utilisateur et le caméscope contre des dommages éventuels.

Ne pas transporter ou saisir le caméscope par l'écran LCD, car il pourrait tomber ou s'endommager.

Ne pas utiliser de trépied photographique sur des surfaces irrégulières et inclinées. Il pourrait tomber et le caméscope pourrait être sérieusement endommagé.

Attention!

Avec des câbles (Audio/Vidéo, etc.) raccordés, il est recommandé de ne pas laisser le caméscope sur le dessus du téléviseur, car tirer sur les câbles pourrait faire tomber le caméscope, causant des dommages.

**IMPORTANT (for owners in the U.K.)
Connection to the mains supply in
the United Kingdom.
DO NOT cut off the mains plug from
this equipment.**

If the plug fitted is not suitable for the power points in your home or the cable is too short to reach a power point, then obtain an appropriate safety approved extension lead or contact the local dealers in your area.

BE SURE to replace the fuse only with an identical approved type, as originally fitted, and to replace the fuse cover.

If nonetheless the mains plug is cut off be sure to remove the fuse and dispose of the plug immediately, to avoid possible shock hazard by inadvertent connection to the mains supply.

If this product is not supplied fitted with a mains plug then follow the instructions given below:

DO NOT make any connection to the Larger Terminal coded E or Green. The wires in the mains lead are coloured in accordance with the following code:

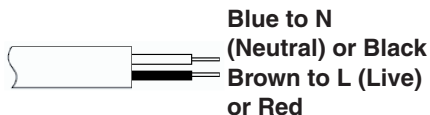

If these colours do not correspond with the terminal identifications of your plug, connect as follows:

Blue wire to terminal coded N (Neutral) or coloured black.

Brown wire to terminal coded L (Live) or coloured Red.

If in doubt — consult a competent electrician.

CAUTIONS:

To prevent shock, do not open the cabinet. No user serviceable parts inside. Refer servicing to qualified personnel.

WARNING

Operation of this equipment in a residential environment could cause radio interference.

CAUTION:

Where there are strong electromagnetic waves or magnetism, for example near a radio or TV transmitter, transformer, motor, etc., the picture and the sound may be disturbed. In such case, please keep the apparatus away from the sources of the disturbance.

The plastics packaging bags may cause suffocation when they are covered over the head. Tear them open, and keep them away from the reach of infants and children by ensuring that they are disposed of properly.

CHE

Wireless LAN

- This device is a 2.4 GHz wideband transmission system (transceiver), intended for use in all EU member states and EFTA countries, except in France and Italy where restrictive use applies.
- In Italy the end-user should apply for a license at the national spectrum authorities in order to obtain authorization to use the device for setting up outdoor radio links and/or for supplying public access to telecommunications and/or network services.
- This device may not be used for setting up outdoor radio links in France and in some areas the RF output power may be limited to 10 mW EIRP in the frequency range of 2454 - 2483.5 MHz. For detailed information the end-user should contact the national spectrum authority in France.

Frequency Range	2.4GHz Band : 1 - 13ch
Output Power	11 b/g/n : 14 dBm (max)
Frequency Range	5GHz Band : W52/W53/W56
Output Power	11 n/a/ac : 11 dBm (max)

CHE RCHE

The European representative of
JVCKENWOOD Corporation is:

Die europäische Vertretung für die
JVCKENWOOD Corporation ist:

JVCKENWOOD Deutschland GmbH
Konrad-Adenauer-Allee 1-11
61118 Bad Vilbel
GERMANY

RCHE

Dear customer,
this apparatus is in compliance with the
valid European Directive and the
relevant standards regarding
electromagnetic compatibility.

Sehr geehrter Kunde, sehr geehrte
Kundin,
dieses Gerät stimmt mit der gültigen
europäischen Richtlinie und den
relevanten Normen bezüglich
elektromagnetischer Verträglichkeit
überein.

CHE

Hereby, JVCKENWOOD Corporation
declares that the radio equipment type
GY-HC900CHE is in compliance with
Directive 2014/53/EU.

The full text of the EU declaration of
conformity is available at the following
internet address:

Hiermit erklärt die , JVCKENWOOD
Corporation, dass der Funkanlagentyp
GY-HC900CHE der Richtlinie
2014/53/EU entspricht.

Der vollständige Text der
EU-Konformitätserklärung ist unter der
folgenden Internetadresse verfügbar:



<http://www3.jvckenwood.com/ecdoc/>

■ Para Brasil

Informação sobre eliminação de baterias

Este produto não deverá ser eliminado como lixo doméstico em geral. Devolva a bateria velha ao comerciante ou para a rede autorizada, para que seja devolvida ao fabricante ou importador. A reciclagem e eliminação de lixo em uma maneira adequada, ajudarão para preservar recursos, prevenindo, ao mesmo tempo, contra efeitos prejudiciais sobre a nossa saúde e o meio ambiente.

Contents

Introduction

Safety Precautions	5
Contents	11
Main Features	14
Precautions for Proper Use	16
Operation Modes	20
Names of Parts	22
Side Control Panel	24
Side Terminal Section	26
Rear Terminal	27
Electronic Viewfinder CHU CHE	28
Basic System Diagram	29

Preparations

Settings and Adjustments Before Use	30
Attaching the Lens (Sold Separately)	30
Attaching the Viewfinder (Supplied) CHU CHE	30
Attaching the Microphone (Sold Separately)	31
Attaching the Video Light (Sold Separately)	31
Attaching the Wireless LAN Antennas (Supplied) CHU CHE	32
Attaching the Tripod (Sold Separately)	32
Adjusting the Position of the Shoulder Pad ..	32
Power Supply	33
Using AC Power (DC IN Power)	33
Using a Battery Pack	34
Battery Warning Settings	35
Power Status Display	36
Turning On/Off the Power	37
Initial Settings	38
Displays on the LCD Monitor and Viewfinder ..	40
Display Screen	40
Status Screen	41
Remote Edit Mode Screen	41
Warning Display	41
Adjusting the LCD Monitor and Viewfinder	42
Adjusting the LCD Monitor	42
Adjusting the Viewfinder	42
Adjusting the Back Focus	44
Assignment of Functions to User Buttons	45
Tally Lamp	46
Recording Media	47
Usable Cards	47
Usable SSD Media	47
Estimated Recordable Time of SD Cards	47
Estimated Recordable Time of SSD Media ..	48
Inserting an SD Card	49
Removing the SD Card	49

Switching the SD cards	50
Inserting the SSD Media Adapter (Sold Separately)	50
Formatting (Initializing) of Recording Media ..	51
Repairing the Recording Media	52
Clips Recorded to Recording Media	53
Operation Lock Feature	54

Shooting

Basic Shooting Procedures	55
Selecting System Definition, File Format and Video Format	56
Zoom Operation	59
Focus Operation	59
Adjusting the Brightness	60
Adjusting the Iris	61
Setting the Gain	62
Setting the Electronic Shutter	63
Adjusting the White Balance	65
Adjusting the Camera Image	70
Audio Recording	71
Audio Output during Recording	75
Time Code and User's Bit	75
Setting Time Code Generator	76
Setting the User's Bit	79
Synchronizing the Time Code with an External Time Code Generator	80
Setting Zebra Pattern	82
Setting Spot Meter	83
Acquiring Positioning Information by GPS CHU CHE	85
Viewing Recorded Videos Immediately (Clip Review)	86
Displaying the Video Signal Monitor	87
Recording Simultaneously at Two Different Definitions	88
Series Rec	88
Dual Rec	88
Backup Rec	90
Special Recording	92
Pre Rec	92
Clip Continuous Rec	93
Frame Rec	94
Interval Rec	95
Splitting the Clips Freely (Clip Cutter Trig)	96

Playback

Playing Recorded Clips	97
Thumbnail Screen	97
Actions	99
Playing back	100
Deleting Clips	102
Appending/Deleting OK Mark	103
Selecting and Performing Operations on Multiple Clips	104
Selecting Multiple Clips Randomly	104
Selecting Multiple Clips Consecutively	105
Trimming Recorded Clips	106

Menu Display and Detailed Settings

Basic Operations in Menu Screen	107
Display and Description of the Menu Screen	108
Text Input with Software Keyboard	109
Menu Screen Hierarchical Chart	110
Camera Function Menu	111
User Switch Set Item	113
Full Auto Item	117
Camera Process Menu	118
Detail/Adjust Item	123
White Balance Item	124
TC/UB Menu	126
LCD/VF Menu	128
Shooting Assist Item	129
Marker Settings Item	131
Display Type Item	132
Display On/Off Item	133
A/V Set Menu	134
Video Set Item	134
Audio Set Item	138
Network Menu	143
Connection Setup Item	144
Live Streaming Item	145
Return over IP Item	149
Web Item	152
Metadata Server Item	152
Upload Item	153
Overlay Settings Menu	155
System Menu	157
Record Set Item	160
Adding/Editing Frequently Used Menu Items (Favorites Menu)	166
Adding Menu Items to Favorites Menu	166
Editing Favorites Menu	167

Display/Status Screen

Display Screen in Camera Mode	170
Display Screen in Media Mode	176
Status Screen	179

Camera Features

Marker and Safety Zone Displays (Camera Mode Only)	181
Color Bar Output	182
Adjusting the Gamma	182
Adjusting Color Matrix	183
Configuring Setup Files	185
Saving Setup Files	186
Loading a Setup File	187
Deleting Setup Files	187

Connecting External Devices

Connecting External Monitor	188
Connecting a Remote Control Unit	189
Connecting the Headphone	190
Inputting External Synchronizing Signals (Genlock)	191
Displaying Return Videos from an External Device	193

Network

Functions of Network Connection	194
Preparing Network Connection	195
Operating Environment	195
Camera Setup for Network Connection	195
Connecting to Network via [LAN] Terminal	195
Connecting to Network via [HOST] Terminal (USB)	196
Connecting to Network via Built-in Wireless LAN CHU CHE	197
Importing Metadata	198
Preparing Metadata	198
Configuring the Server for Downloading	198
Importing Metadata	199
Uploading a Recorded Video Clip	200
Configuring the FTP Server for Uploading	200
Uploading Clips Automatically (Auto FTP)	200
Automatic Chunked Upload to FTP Server	201
Uploading Clips Manually (Manual FTP)	201
FTP Resume Feature	204
Connecting from a Web Browser	204
Editing Metadata	205
Planning Metadata	205
Clip Metadata	206
Uploading a Recording Clip via a Web Browser	209
View Remote Control and Camera Control Functions	212
Changing the Settings via a Web Browser	214
Changing View Remote Function Settings	215

Changing Connection Setup	215
Changing Metadata Server Settings	216
Changing Clip Server Settings	216
Changing Streaming Settings	216
Managing the Network Connection Settings File	217
Saving the Connection Settings File	217
Reading the Connection Settings File	218
Deleting Connection Settings	219
Performing Live Streaming	220
Setting Distribution	223
Starting Distribution	225
Setting the FEC Matrix	226
Return Video/Audio from the Network (Return over IP)	227
IFB (Return Audio)	228
Tagging Feature CHU STU	229
Configuring to Exchange Format	229
Configuring Camera Angle Information	229
Entering Tag Information	229
Synchronizing GPS Time Code CHU	230
Overlay	
Broadcast Overlay	231
Importing and Configuring Settings for SDP Files for Broadcast	231
Displaying Watermark Images	233
Displaying Images on the Whole Screen (Full Screen Graphic Function)	233
Protecting Overlay Settings with a Password	235
Specifying Text and Images	236
Others	
Error Messages and Actions	237
List of FTP Transfer Errors	239
List of Live Streaming Error Displays	241
Blinking of the Tally Lamp	242
Warning Tone	242
Troubleshooting	243
Specifications	246
Appendix	251
Index	252
Software License Agreement	254
Important Notice concerning the Software	255

Main Features

A variety of wired and wireless interfaces to support various network connections

In addition to the USB host terminal for wireless LAN and LTE USB adapter connections, this camera recorder is equipped with a variety of interfaces such as wired LAN terminal and built-in wireless LAN with 2.4GHz/5GHz MIMO dual band antennas **CHU** **CHE** to support various network connections.

Three full HD 2/3-inch CMOS image sensors for high sensitivity of F12, low noise high quality recording

This camera recorder is equipped with three 2/3-inch 2.20M pixels full HD CMOS image sensors. It delivers high sensitivity of F12, low noise high quality recordings.

2/3-inch B4 lens mount system equipped with B4 lens mount and 4-position optical ND filter

This camera recorder comes with a 2/3-inch B4 lens mount system equipped with B4 lens mount and 4-position optical ND filter. A wide range of B4 mount lenses can be used. Furthermore, when a B4 lens with chromatic aberration compensation data is installed, chromatic aberration can be corrected on the camera recorder. By switching the 4-position ND filter (CLEAR, 1/4, 1/16, 1/64), the amount of light can be adjusted according to the brightness during shooting.

High quality signal processing by 10-bit, 4:2:2 sampling

High quality signal processing that delivers rich gradation expression and color reproduction of video signals is possible by means of 10-bit, 4:2:2 sampling.

Various usage-based recording formats

The recording codec supports two types of formats that are compatible with the 4:2:2 10-bit formats widely used by broadcasting stations, namely MPEG-4 AVC/H.264 and MPEG-2. All file formats are compatible with QuickTime (MOV).

Newly developed user multi-matrix for 16-axis color correction

In addition to the conventional 6-axis user linear matrix adjustment, this camera recorder is equipped with user multi-matrix that enables accurate adjustment of hue and saturation in the smaller 16-axis color region.

HDR and log gamma for high dynamic range and high color gamut

This camera recorder is equipped with HLG (Hybrid Log-Gamma) that conforms to ITU-BT.2100 and our in-house J-Log1 Gamma with 800% dynamic range to cope with HDR (High Dynamic Range). Capable of recording in 10-bit for high dynamic range and high color gamut.

Double SD card slots for series/dual recordings

The most common SDHC/SDXC card recording system is used for the memory card. This ensures high reliability and operation at low running cost. Various user friendly recording options are available. These include series recording which enables seamless long hour continuous recordings over the slots and dual recording of the same file to two slots.

3.26-inch OLED electronic viewfinder and 3.5-inch LCD monitor (with focus assist function)

This camera recorder supports focusing through the 3.26-inch OLED electronic viewfinder and 3.5-inch LCD monitor. Other assist functions are also available, including magnified focus on a manually selected point.

Time code input/output and genlock terminals for shooting using multiple cameras

This camera recorder supports the use of multiple cameras as well as studio use.

Professional-style switch layout and diverse video parameters

Switches for Gain and White Balance are available on the side panel to enable quick switching according to the shooting scene. Image quality parameters such as gamma and color matrix are also available in the menu for adjustment to the preferred tones.

Built-in GPS **CHU** **CHE**

This camera recorder is built in with GPS function, which enables the positional information obtained from the GPS satellite during a shoot to be recorded as metadata.

- * Note that acquisition of the positional information may fail depending on the weather condition.

User buttons/switches assignable with different functions for greater ease of use

Menu items corresponding to each user button are available to assign the buttons with different functions.

“IPX2” standard equivalent waterproof function for shooting in the rain

SDI pool feed for simultaneous recording and streaming of videos

Symbols used

- Caution** : Describes precautions concerning the operation of this product.
- Memo** : Describes reference information, such as functions and usage restrictions of this product.
-  : Indicates the reference page numbers and reference items.
- CHU** : Feature available on GY-HC900CHU only.
- CHE** : Feature available on GY-HC900CHE only.
- STU** : Feature available on GY-HC900STU only.
- RCHE** : Feature available on GY-HC900RCHE only.

Content of this manual

- All rights reserved by JVCKENWOOD Corporation. Unauthorized duplication or reprinting of this manual, in whole or in part, is strictly prohibited.
- Illustrated designs, specifications and other contents of this manual are subject to change for improvement without prior notice.
- SDXC and SDHC logos are trademarks of SD-3C, LLC.
- The terms HDMI and HDMI High-Definition Multimedia Interface, and the HDMI Logo are trademarks or registered trademarks of HDMI Licensing Administrator, Inc. in the United States and other countries.
- QuickTime, Final Cut Pro, Finder, iPhone, iPad, iPod touch, macOS and Safari are registered trademarks of Apple Inc. in the U.S. and other countries.
- iOS is a trademark or registered trademark of Cisco in the U.S. and other countries and is used under license.
- Android and Google Chrome are trademarks and/or registered trademarks of Google LLC.
- QR Code is a registered trademark of Denso Wave Incorporated.
- Microsoft and Windows are registered trademarks of U.S.-based Microsoft Corporation in the U.S. and other countries.
- The company name of Fontworks, Fontworks, and the name of the fonts are registered trademarks of Fontworks Inc.
- Zixi and the Zixi logo are trademarks of Zixi LLC.
- UniSlot is a registered trademark of Ikegami Tsushinki Co., Ltd.
- Other product and company names included in this instruction manual are trademarks and/or registered trademarks of their respective companies. Marks such as TM and © have been omitted in this manual.

Descriptions in this manual are based on firmware version V0410.

Precautions for Proper Use

Storage and Usage Locations

- Allowable ambient temperature and humidity
Be sure to use this unit within the allowable temperature range of 0 °C to 40 °C (32 °F to 104°F) and a relative humidity of 30 % to 80 %. Using this unit at a temperature or humidity outside the allowable ranges could result not only in malfunction but also serious impact on the CMOS elements as small white spots may be generated. Please exercise care during use.
- Strong electromagnetic waves or magnetism
Noise may appear in the picture or audio and/or the colors may be incorrect if this unit is used near a radio or television transmitting antenna, in places where strong magnetic fields are generated by transformers, motors, etc., or near devices emitting radio waves, such as transceivers or cellular phones.
- Use of wireless microphone near this unit
When a wireless microphone or wireless microphone tuner is used near this unit during recording, the tuner could pick up noise.
- Avoid using or placing this unit in the following places.
 - Places subject to extreme heat or cold
 - Places with excessive dirt or dust
 - Places with high humidity or moisture
 - Places subject to smoke or vapor such as near a cooking stove
 - Places subject to strong vibrations or unstable surfaces
 - In a parked car under direct sunlight or near a heater for long hours
- Do not place this unit at places that are subject to radiation or X-rays, or where corrosive gases occur.
- Protect this unit from getting wet when shooting on a beach. In addition, salt and sand may adhere to the body. Be sure to clean the unit after use.
- Protect this unit against penetration of dust when using it in a place subject to sandy dust.

Drip-proof

- This camera recorder has a drip-proof structure equivalent to IPX2 according to our testing method. It is not completely waterproof. And the drip-proof performance under all conditions is not guaranteed.
 - IPX2 (protection rating against dripping water) ensures that when a device is tilted at an angle of 15 degrees to the front, back, right and left with water dripping vertically on it at a rate of 3 mm/min for a total of 10 minutes at 2 minutes 30 seconds for each position, the device will function properly when operated.
- To ensure the drip-proof performance, close the caps and covers fully.
- Avoid heavy rain and heavy water splashes.
- If this camera recorder gets wet and there are water droplets, wipe off with a dry cloth immediately. If the camera recorder is turned upside down or tilted at 15 ° or more while it is wet, water may enter the camera recorder and cause malfunction.
- If this camera recorder gets wet, water may come out from the gaps. Do not carry it while it is wet. Place it on a dry cloth for a while and let it dry.

Carrying the Camera

- Do not drop or hit this unit against a hard object when transporting.

Power Saving

- When this unit is not in use, be sure to set the [POWER ON/OFF] switch to "OFF" in order to reduce power consumption.

Maintenance

- Turn off the power before performing any maintenance.
- Wipe the external cabinet of the unit with a soft cloth. Do not wipe the body with benzene or thinner. Doing so may cause the surface to melt or turn cloudy. When it is extremely dirty, soak the cloth in a solution of neutral detergent, wipe the body with it, and then use a clean cloth to remove the detergent.

Rechargeable Battery

- The batteries recommended for use with this camera recorder are as follows.
U model : Digital 150 (Anton/Bauer)
E model : DUO-C198, DUO-C98 (IDX)
- Please make use of one of the recommended batteries.
Heavy batteries may fall off if they are not used correctly.

Regular Inspection (Maintenance)

- Under normal environment, dust will accumulate on the camera recorder when it is used over a long period. Dust may enter the camera recorder especially if it is used outdoors. This may affect the image and sound quality of the camera recorder. Check and replace the fan after every 9000 hours (suggested guideline). You can check the usage time of the fan in [System] → [System Information] → [Fan Hour]. (☞ P159 [Fan Hour])
If the fan is used for more than 9000 hours without replacement, "Fan Maintenance Required" will be displayed every time you turn on the power.

LCD Monitor and Viewfinder **CHU** **CHE**

- The LCD monitor and viewfinder screen are manufactured using high-precision technology. Black or bright spots may appear on the LCD monitor and viewfinder screen. This is not a malfunction. These spots will not be recorded.
- If you use this unit continuously for a long period of time, the characters displayed in the viewfinder may temporarily remain on the screen. This phenomenon will not be recorded to the recording media. They will not appear after you turn the power off and then on again.
- If you use this unit in a cold place, the images may appear to lag on the screen, but this is not a malfunction. Retained images are not recorded on the SD card.
- Do not press against the surface with force or subject it to strong impact. Doing so may damage or break the screens.
- Noise may appear in the viewfinder when switching between the live video and playback images.
- Due to the characteristic of the viewfinder display device, colors may appear on the images when you blink your eyes. It does not affect the recorded images, SDI output, or HDMI output.

Lens

- This camera recorder is an interchangeable lens camera. Please have the interchangeable lens ready before use.
- Read the "INSTRUCTIONS" of the interchangeable lens to be attached to get a full understanding before use.
- Optical performance of lens
Due to the optical performance of the lens, color divergence phenomena (magnification chromatic aberration) may occur at the periphery of the image. This is not a camera malfunction.
- Depending on the lens attached, there are function limitations on the lens with this camera recorder or the lens may not function properly.
- The lens operation sound may be recorded.
- Depending on the lens used, the approximate distance to the subject may not be displayed.
- There can be a large variation in the light intensity during Auto Iris mode, Manual Iris mode and zoom mode.

GPS **CHU** **CHE**

- The GPS (Global Positioning System) satellites are managed by the Department of State of the U.S., and its precision may be altered intentionally.
- Perform positioning at an unobstructed location with a clear view that is not indoors or blocked by trees.
- The time needed for obtaining the position information may be longer and variation may also be larger depending on the surrounding environment and time of day.
- This camera recorder uses the WGS 84 World Geodetic System.
- Signal from GPS satellites may be interrupted by communication signal from electronic devices such as mobile phones.
- Make use of it in accordance with the regulations of the country, region or location of use.

Encryption in Network Connection

- Wireless LAN connections make use of an encryption function.
This encryption is designed for commercially-sold equipment, and it cannot be altered.

SDHC/SDXC Cards

- SDHC/SDXC card is referred to as “SD card” or “recording media” in this manual.
 - This camera recorder saves the recorded images and audio sound on the SD card (sold separately) in the card slot.
 - If the SD card contains files recorded by devices other than this camera recorder or files that are saved from a PC, the recordable time may be shorter or data may not be properly recorded. In addition, the remaining space on the card may not increase even when files are deleted using a PC.
 - For details on the combinations of usable SD card and format setting, refer to the following. (P47 [Format Setting and Usable SD Card Combinations])
- * Using cards other than those from Panasonic, TOSHIBA or SanDisk may result in recording failure or data loss.

Handling of SD Cards

- The status indicator lights up in red when data on the SD card is being accessed. Do not remove the SD card during data access (such as recording, playback, or formatting). Do not turn off the power or remove the battery and AC adapter during access either.
- Do not use or store the SD card in a place that is subject to static electricity or electrical noise.
- Do not place the SD card near locations that are exposed to strong magnetic fields or radio waves.
- Inserting the SD card incorrectly may result in damage of this unit or the SD card.
- We are not liable for any accidental loss of data stored on the SD card. Please back up any important data.
- Make use of the SD card within the prescribed conditions of use. Do not use it at the following locations. Places that are subject to direct sunlight, high humidity or corrosion, places near thermal equipment, sandy or dusty places, or in a car under the sun with the doors and windows closed.
- Do not bend or drop the SD card, or subject it to strong impact or vibration.
- Do not splash the SD card with water.
- Do not dismantle or modify the SD card.
- Do not touch the terminals with your hands or with a metal object.
- Do not allow dust, dirt, water, or foreign objects to adhere to the terminals.
- Do not remove the labels or stick other labels or stickers on the SD cards.

- Do not use pencils or ballpoint pens to write on the SD cards. Always use oil-based pens.
- If you format (initialize) the SD card, all data recorded on the card, including video data and setup files, will be deleted.
- You are recommended to use cards that are formatted (initialized) on this camera recorder.
 - The SD card may be damaged if the camera recorder is not operated correctly. Formatting (Initializing) the SD card may allow it to operate correctly.
 - SD cards that have been formatted (initialized) on other cameras, computers or peripheral equipment may not operate correctly. In this case, format (initialize) the SD card on this camera recorder.
- If you want to wipe out all information by completely erasing the data, we recommend either using commercially available software that is specially designed for that purpose, or by physically destroying the SD card with a hammer, etc. When formatting or erasing data using the camera recorder, only the file administration information is changed. The data is not completely erased from the SD card.
- Some commercially available SD cards may be harder to be removed from this unit. Remove them by hooking onto the groove on the cards.
 - It will be easier to remove the cards after several times.
 - Do not stick any stickers on the cards.



- The SD card may pop out when it is being removed. Be careful not to lose the card.

Copyright

- Any recordings made on this camera recorder that are played back for profit or public preview may infringe on the rights of the owner of the recordings. Do not use the recordings for purpose other than personal enjoyment without prior consent from the owner. And even for personal enjoyment, you may not be able to record without permission from the owner.

License Notices

- **MPEG LA AVC**
THIS PRODUCT IS LICENSED UNDER THE AVC PATENT PORTFOLIO LICENSE FOR THE PERSONAL USE OF A CONSUMER OR OTHER USES IN WHICH IT DOES NOT RECEIVE REMUNERATION TO

(i) ENCODE VIDEO IN COMPLIANCE WITH THE AVC STANDARD (“AVC VIDEO”) AND/OR

(ii) DECODE AVC VIDEO THAT WAS ENCODED BY A CONSUMER ENGAGED IN A PERSONAL ACTIVITY AND/OR WAS OBTAINED FROM A VIDEO PROVIDER LICENSED TO PROVIDE AVC VIDEO. NO LICENSE IS GRANTED OR SHALL BE IMPLIED FOR ANY OTHER USE. ADDITIONAL INFORMATION MAY BE OBTAINED FROM MPEG LA, L.L.C. SEE [HTTP://WWW.MPEGLA.COM](http://www.mpegla.com)
- **MPEG LA MPEG-2 Patent**
ANY USE OF THIS UNIT IN ANY MANNER OTHER THAN PERSONAL USE THAT COMPLIES WITH THE MPEG-2 STANDARD FOR ENCODING VIDEO INFORMATION FOR PACKAGED MEDIA IS EXPRESSLY PROHIBITED WITHOUT A LICENSE UNDER APPLICABLE PATENTS IN THE MPEG-2 PATENT PORTFOLIO, WHICH LICENSE IS AVAILABLE FROM MPEG LA, LLC, 6312 S. WHICH LICENSE IS AVAILABLE FROM MPEG LA, LLC, 6312 S. Fiddlers Green circle, Suite 400E, Greenwood Village, Colorado 80111 U.S.A.

Others

- Do not insert objects other than the memory card into the card slot.
- Do not block the vent on the unit. Blocking of the vent causes internal heating and may lead to burns and fires.
- Do not turn off the [POWER ON/OFF] switch or remove the power cable during recording or playback.
- The camera recorder may not show stable pictures for a few seconds immediately after the power is turned on, but this is not a malfunction.
- When the video signal output terminals are not in use, put on the covers to prevent damage to the terminals.
- Do not drop this unit or subject it to strong impact or vibration as it is a precision equipment.
- Noise may appear in the image when switching modes.
- If placed on its side, heat release efficiency will deteriorate.
- When the connectors that come with connector covers are not in use, put on the covers to prevent damage to the connectors.
- This camera recorder makes use of fonts by Fontworks Inc.
- This camera recorder makes use of M+ FONTS.
- Use the built-in wireless LAN only in the country and region where it was purchased. And there are legal restrictions on the use and outdoor use depending on the country and region. Please be careful not to violate the law.

CHU CHE

Operation Modes

This camera recorder has three operation modes - Camera mode, Media mode, and Remote Edit mode.

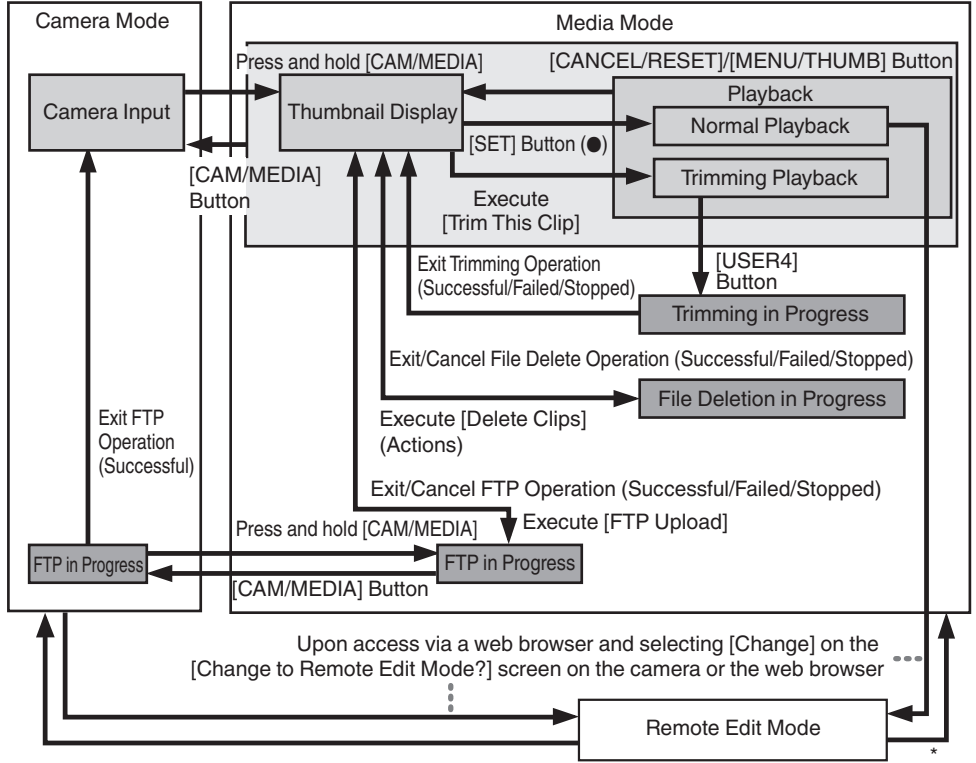

* Selecting a mode other than the Metadata Edit mode via the web browser, or selecting [Exit] on the [Remote Edit Mode] screen

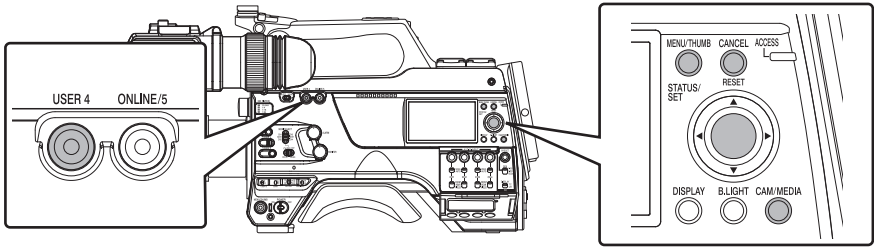

Operation Mode	Description
Camera Mode	<ul style="list-style-type: none"> ● This is the camera shooting mode. The camera recorder starts up in Camera mode when the power is turned on. ● Camera images are output to the viewfinder and LCD monitor. When a recordable media is inserted, the camera recorder enters the recording standby mode. “STBY” appears on the operation mode display area of the LCD monitor and viewfinder. ● Press the [REC] trigger button to start recording. ● When [Record Set] → [Record Format] → [System] is set to “HD(SDI In)” or “SD(SDI In)”, and the device is connected to the [HD/SD SDI IN] terminal, the SDI input video is displayed on the LCD monitor or viewfinder. <p>Memo : _____</p> <ul style="list-style-type: none"> ● Playback of recording media is not possible in the Camera mode. However, you can check the most recently recorded video clip. (☞ P86 [Viewing Recorded Videos Immediately (Clip Review)])
Media Mode	<ul style="list-style-type: none"> ● This mode allows you to play back or delete clips recorded on the recording media. ● When a playable recording media is inserted, the thumbnail or playback screen is displayed on the viewfinder and LCD monitor. ● Press and hold the [CAM/MEDIA] button to enter the Media mode when you are not shooting in the Camera mode. Once the camera recorder is in Media mode, thumbnails of the selected media slot are displayed.
Remote Edit Mode	<ul style="list-style-type: none"> ● This mode enables the list display and editing of the recorded clip data through access to the clip list display page via a web browser on a smartphone, tablet terminal, or PC. ● When you access via a web browser on a smartphone, tablet terminal, or PC, “It is necessary to change the camera mode to "Remote Edit Mode". Change the mode.” appears on the web browser. Also, “Change to Remote Edit Mode?” is displayed on the display screen of the camera unit. Selecting [Change] on the camera recorder and pressing the Set button switches to the Remote Edit mode, and enables display of the clip list and editing of the clip metadata. (☞ P206 [Clip Metadata]) (☞ P209 [Uploading a Recording Clip via a Web Browser]) <p>Memo : _____</p> <ul style="list-style-type: none"> ● If you access via a web browser on devices such as a smartphone, tablet terminal, or PC while recording is in progress, the message appears after recording stops. ● If playback is in progress, the message appears once the files are closed automatically, such as when playback stops.

Names of Parts

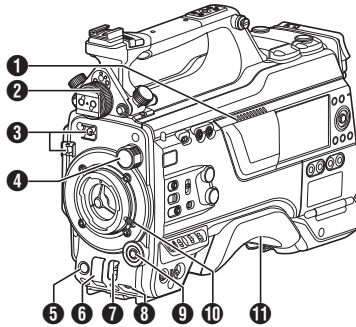

- 1** Speaker
 (☞ P100 [Audio Output during Playback])
- 2** Viewfinder Left-Right Position Lock Ring
 For loosening the ring and adjusting the position of the viewfinder to the left or right.
 (☞ P30 [Attaching the Viewfinder (Supplied) **CHU** **CHE**])
- 3** Cable Clamp
- 4** [ND FILTER] Switch
 Use the ND filter to keep the lens aperture in the appropriate range.
 1: CLEAR, 2: 1/4, 3: 1/16, 4: 1/64
- Memo : _____
 • It is recommended to use the ND filter to set the lens aperture to less than F8.
- 5** [REC] Button
 Starts/stops recording.
- 6** [SHUTTER] Switch
 Push the switch up to turn off the shutter, and push it down to change the shutter speed.
 (☞ P63 [Setting the Electronic Shutter])
- 7** [AWB/USER8] Switch

 - Push the switch up for it to function as a AWB switch. When the [WHT.BAL PRST/A/B] switch is set to “PRST”, AWB changes the color temperature according to the preset white balance, and applies Auto White Balance when the switch is set to “A” or “B”.
 (☞ P65 [Adjusting the White Balance])
 - Push the switch down for it to function as a user button. It can be assigned with a specific menu function.
 (☞ P45 [Assignment of Functions to User Buttons])
- 8** [MIC LEVEL] Knob
 For manual adjustment of the recording level for the microphone that is attached to the [MIC IN] terminal when the [AUDIO SELECT CH1/2/3/4]-[MANUAL/AUTO] selection switch is set to “MANUAL” and the [FRONT/REAR/WIRELESS] selection switch is set to “FRONT”.
 (☞ P71 [Audio Recording])
- 9** Cross-shaped (▲▼◀▶)/[SET/USER13] Button (●)

 - For operating the menu and cursor and for confirming a setting, as well as for configuring the settings for time code and user’s bit.
 - When in the Camera mode (menu is not displayed), pressing the [SET/USER13] button displays the status screen.
 - When a function is assigned to the cross-shaped button or [SET/USER13] button, it functions as a user button. Initial setting for [USER13]: Status
 (☞ P45 [Assignment of Functions to User Buttons])
- 10** Lens Lock Lever
 (☞ P30 [Attaching the Lens (Sold Separately)])
- 11** Shoulder Pad
 (☞ P32 [Adjusting the Position of the Shoulder Pad])

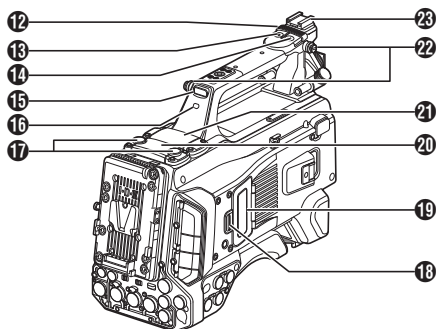

- 12** Slide Cover (For [USER6]/[USER7] Button)
Sliding the cover over the buttons helps to prevent accidental operation.
- 13** [USER6] Button
It can be assigned with a specific menu function. (☞ P45 [Assignment of Functions to User Buttons])
- 14** [USER7] Button
It can be assigned with a specific menu function. (☞ P45 [Assignment of Functions to User Buttons])
- 15** Back Tally Lamp (Handle)
(☞ P46 [Tally Lamp])
- 16** [TALLY] Switch
(☞ P46 [Tally Lamp])
(☞ P242 [Blinking of the Tally Lamp])
- 17** Wireless LAN Antenna Terminal **CHU CHE**
(☞ P32 [Attaching the Wireless LAN Antennas (Supplied) **CHU CHE**])
- 18** SD Card Cover Knob
(☞ P49 [Inserting an SD Card])
- 19** SD Card Cover
- 20** Expansion slot
SSD Media Adapter (sold separately) such as KA-MC100 can be inserted into the slot.
(☞ P50 [Inserting the SSD Media Adapter (Sold Separately)])
- 21** Wireless Audio Receiver Mounting Slot ("UniSlot")
A "UniSlot" wireless receiver can be attached to this slot.
- 22** Shoulder Belt Mount (x2)
For mounting a shoulder belt (sold separately).
Caution : _____
- Be sure to use a shoulder belt with the strength to withstand the weight of this camera recorder.
 - If the shoulder belt is not properly attached, the camera recorder may fall and cause injuries.
 - Check the [INSTRUCTIONS] provided with the shoulder belt before using.
-
- 23** Shoe
For mounting separately sold video lights and accessories.
(☞ P31 [Attaching the Video Light (Sold Separately)])

Memo : _____

- When removing the cover, avoid losing the screws, etc.
- Check the "INSTRUCTIONS" of the wireless receiver.

Side Control Panel

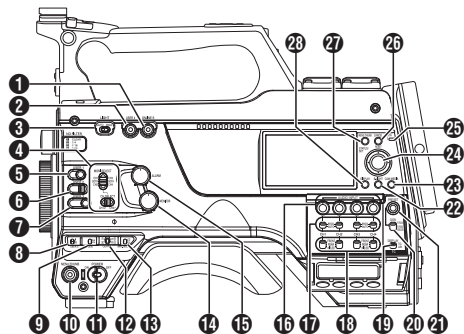

- 1** [ONLINE/5] Button
- Switches live streaming between ON/OFF. (☞ P225 [Starting Distribution])
 - You can also use it as a user button by assigning a specific feature in the menu setting to this button. Initial setting: Live streaming (☞ P45 [Assignment of Functions to User Buttons])
- 2** [USER4] Button
- It can be assigned with a specific menu function. (☞ P45 [Assignment of Functions to User Buttons])
- 3** [LIGHT] Switch
- For selecting the operation mode of the video light connected to the [LIGHT] terminal.
- AUTO** : The video light lights up only during recording when the video light is turned on.
- MANUAL**: The video light lights up or goes off when the video light is turned on or off.
- 4** [MONI SELECT] Switch/[CH SELECT] Switch
- For configuring the audio monitor (speaker/headphone) output with the combined use of two switches. (☞ P190 [Connecting the Headphone])
- 5** [USER1] Button
- It can be assigned with a specific menu function. (☞ P45 [Assignment of Functions to User Buttons])
- 6** [USER2] Switch
- It can be assigned with a specific menu function. (☞ P45 [Assignment of Functions to User Buttons])

Memo : _____

- Even when the function assigned to the [USER2] switch is assigned to another user button at the same time, only the [USER2] switch is enabled.

- 7** [USER3] Button
- It can be assigned with a specific menu function. (☞ P45 [Assignment of Functions to User Buttons])
- 8** [USER0] Switch
- It can be assigned with a specific menu function. (☞ P45 [Assignment of Functions to User Buttons])
- 9** [GAIN H/M/L] Switch
- For selecting the gain sensitivity level. (☞ P62 [Setting the Gain])
- 10** [MENU/THUMB] Button
- Displays the menu screen during Camera mode.
 - Switches between [Main Menu] and [Favorites Menu] when the [MENU/THUMB] button is pressed and held down while the menu screen is displayed. (☞ P107 [Basic Operations in Menu Screen])
 - Displays the menu screen when the button is pressed during thumbnail display in the Media mode.
 - Stops playback and displays the thumbnail screen when the button is pressed during playback screen display in the Media mode.
- 11** [POWER ON/OFF] Switch
- Turns ON/OFF the power.
- When the power is turning OFF, "P.OFF" appears on the LCD monitor and viewfinder.
 - Wait for 5 seconds or more to turn on the power again.
- 12** [OUTPUT] Switch
- For configuring the output signal when in the Camera mode.
- CAM/AUTO KNEE ON: Turns "ON" Auto Knee.
 - CAM/AUTO KNEE OFF: Turns "OFF" Auto Knee.
 - BARS/AUTO KNEE OFF: Outputs a color bar.
- 16** [WHT.BAL PRST/A/B] Switch
- For switching the white balance. (☞ P65 [Adjusting the White Balance])
- 14** [MONITOR] Volume Adjustment Knob
- For adjusting the volume of the audio monitor (speaker/headphone).
- 15** [ALARM] Volume Adjustment Knob
- For adjusting the warning alarm volume of the audio monitor (speaker/headphone).

Memo : _____

- Whether the sound is to be muted or output when it is at the minimum level can be configured in [Min. ALARM Level].

- 16** [AUDIO INPUT CH1/2/3/4] Recording Level Adjustment Knob
For adjusting the recording level manually when the [MANUAL/AUTO] selection switch is set to "MANUAL".
(☞ P71 [Audio Recording])
- 17** [AUDIO CH1/2/3/4]-[MANUAL/AUTO] Selection Switch
For configuring the recording level of each channel to [MANUAL/AUTO].
(☞ P71 [Audio Recording])
- 18** [AUDIO CH1/2/3/4]-[FRONT/REAR/WIRELESS] Selection Switch
For selecting the recording input path [FRONT/REAR/WIRELESS] for each channel.
(☞ P71 [Audio Recording])
- 19** [TC DISPLAY] TC/UB Display Switch
Switches the display between time code and user's bit.
(☞ P75 [Time Code and User's Bit])
(☞ P76 [Setting Time Code Generator])
- 20** [TC GEN] Time Code Generator Switch
For configuring the run mode of the time code.
F-RUN : The time code operates in the run mode at all times. Synchronizes with the external time code when an external time code generator is connected.
R-RUN : The time code operates in the run mode while recording is in progress. When the SD card is replaced, recording continues from where it last stopped using the previous card.
REGEN : The time code operates in the run mode while recording is in progress. When the SD card is replaced, recording starts from the last time code recorded on the current SD card.
(☞ P75 [Time Code and User's Bit])
(☞ P76 [Setting Time Code Generator])
(☞ P80 [Synchronizing the Time Code with an External Time Code Generator])
- 21** [TC PRESET] Button
When the [TC GEN] switch is set to "F-RUN" or "R-RUN", this camera recorder enters or exits Preset mode when this button is pressed. Upon entering Preset mode, an enlarged display appears on the LCD monitor. Use the cross-shaped button to move the cursor and select a value. Next, press the [STATUS/SET] button to preset the time code and the screen returns to the original display.
- Memo : _____
- The UB mode is enabled only when [TC/UB] → [UB Mode] is set to "Preset".
- 22** [B.LIGHT] Button
Sets the LCD monitor backlight. Pressing the button each time switches the mode as follows:
Dark → Normal → Bright → Off → Dark
- 23** [CAM/MEDIA] Button
Switches between the Camera mode and Media mode.
(☞ P20 [Operation Modes])
- 24** Cross-shaped (▲▼◀▶)/[STATUS/SET] Button (●)
- For operating the menu and cursor and for confirming a setting, as well as for configuring the settings for time code and user's bit.
 - When in the Camera mode (menu is not displayed), pressing the [STATUS/SET] button displays the status screen.
 - When a function is assigned to the cross-shaped button, it functions as a user button.
(☞ P45 [Assignment of Functions to User Buttons])
- 25** [ACCESS] Lamp
The indicator lights up in green when the recording media is being accessed.
- Memo : _____
- Regardless of whether a recording media has been inserted, the access lamp will light up for about 5 seconds when the power is turned on.
- 26** [CANCEL/RESET] Button
- Cancels various settings and stops playback.
 - Performs reset when the TC mode or UB mode is being configured during enlarged display on the LCD monitor.

- 27** [MENU/THUMB] Button
- Displays the menu screen during Camera mode.
 - Switches between [Main Menu] and [Favorites Menu] when the [MENU/THUMB] button is pressed and held down while the menu screen is displayed.
- (☞ P107 [Basic Operations in Menu Screen])
- 28** [DISPLAY] Button
- Displays the menu screen when the button is pressed during thumbnail display in the Media mode.
 - Stops playback and displays the thumbnail screen when the button is pressed during playback screen display in the Media mode.
- (☞ P107 [Basic Operations in Menu Screen])
- 28** [DISPLAY] Button
- Press the [DISPLAY] button to switch to the display screen during normal screen display (when the menu screen is not displayed).
- (☞ P40 [Display Screen])
- Switches between [Main Menu] and [Favorites Menu] when the [DISPLAY] button is pressed while the menu screen is displayed.
- (☞ P107 [Basic Operations in Menu Screen])

Side Terminal Section

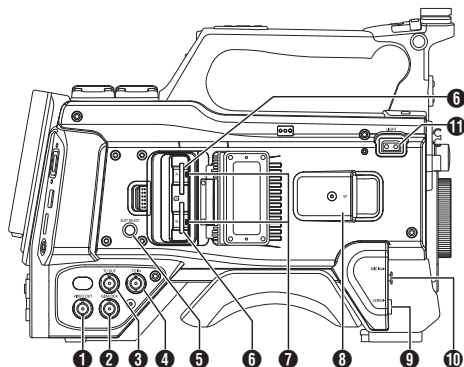

- 1** [VIDEO OUT] Terminal
(☞ P80 [Synchronizing the Time Code with an External Time Code Generator])
- 2** [GENLOCK] Terminal
(☞ P191 [Inputting External Synchronizing Signals (Genlock)])
- 3** [TC OUT] Terminal
(☞ P80 [Synchronizing the Time Code with an External Time Code Generator])
- 4** [TC IN] Terminal
(☞ P80 [Synchronizing the Time Code with an External Time Code Generator])
- 5** [SLOT SELECT] Button
Switches the active card slot during shooting and playback.
- 6** Card Slot A/B
- 7** Access Lamp A/B
- 8** [VF] Terminal
(☞ P30 [Attaching the Viewfinder (Supplied **CHU CHE**)])
- 9** [LENS] Lens Connection Terminal
(☞ P30 [Attaching the Lens (Sold Separately)])
- 10** [MIC IN] Terminal (XLR 5-pin)
(☞ P31 [Attaching the Microphone (Sold Separately)])
- 11** [LIGHT] Terminal
(☞ P31 [Attaching the Video Light])

Rear Terminal

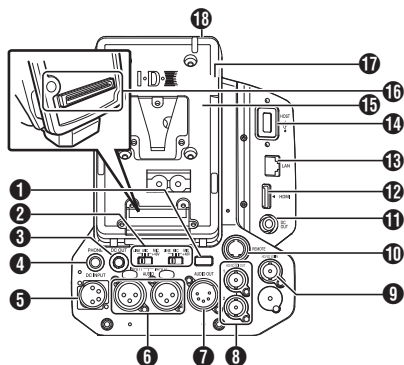

- 1** Back Tally Lamp (Rear)
(☞ P46 [Tally Lamp])
(☞ P242 [Blinking of the Tally Lamp])
- 2** [AUDIO INPUT1/2] Switch
(☞ P71 [Audio Recording])
- 3** [DC OUT] Terminal (Rear)
Supplies power to an externally-connected wireless receiver.

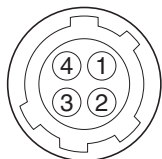

Pin Number	Signal Name
1	UNREG GND
2	NC
3	NC
4	UNREG +12V

Memo : _____

- The pin configurations for **3** and **11** are the same.

Caution : _____

- Do not connect it to any device other than an external wireless receiver.

- 4** [PHONE] Terminal (Φ3.5 mm)
(☞ P190 [Connecting the Headphone])
- 5** [DC INPUT] Terminal
Input terminal for DC 12 V power supply. For connecting a separately sold AC adapter.
(☞ P33 [Using AC Power (DC IN Power)])
- 6** [AUDIO INPUT1/2] Terminal (XLR 3-pin)
- 7** [AUDIO OUT] Terminal (XLR 5-pin)
Outputs audio signals of AUDIO CH1/CH2 or CH3/CH4.
Audio signals are output according to the setting in [A/V Set] → [Audio Set] → [AUDIO OUT Ch.].

- 8** [HD/SD SDI OUT1/2] Terminal
(☞ P188 [Connecting External Monitor])
- 9** [HD/SD SDI IN] Terminal
(☞ P191 [Inputting External Synchronizing Signals (Genlock)])
- 10** [REMOTE] Terminal
(☞ P189 [Connecting a Remote Control Unit])
- 11** [DC OUT] (LAN) Terminal
Supplies power to devices such as a mobile router that is connected to the [LAN] terminal.

Memo : _____

- The pin configurations for **3** and **11** are the same.

- 12** [HDMI] Output Terminal
(☞ P188 [Connecting External Monitor])
- 13** [LAN] Terminal
For connecting the LAN cable.
- 14** [HOST] USB Host Terminal
For connecting a USB adapter according to the intended purpose when you are connecting the unit to a network.

Caution : _____

- When [System] → [Record Set] → [Record Format] → [System] is configured to “High-Speed”, network cannot be used via wireless LAN **CHU CHE** or the [HOST] terminal (USB). Configure as follows in this case.
 - Set [Network] → [Connection Setup] → [USB/Int. WLAN] to “Off”. **CHU CHE**
 - Unplug the USB network adapter
 Note that camera operation will come to an emergency stop and the power will turn off if the above steps are not performed. File data may be damaged if this happens while recording is in progress.

- 15** Battery Loading Folder
The shape varies across the U and E models.
 - * The E model is used in the illustration here.
(☞ P34 [Using a Battery Pack])
- 16** Expansion Unit Terminal
Terminal for connecting a FS-790 (sold separately) or other units.

Memo : _____

- Remove the battery loading folder when using this terminal.

- 17** D-TAP terminal (IDX) **CHE RCHE**
- 18** D-TAP terminal (Anton/Bauer) **CHU STU**

Electronic Viewfinder **CHU** **CHE**

(☞ P42 [Adjusting the Viewfinder])

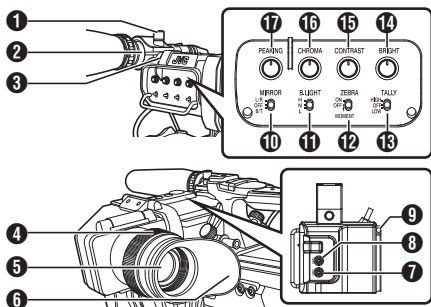

- 1** Microphone Holder Lock Knob
- 2** Microphone Holder
- 3** Front Tally Lamp
(☞ P46 [Tally Lamp])
(☞ P242 [Blinking of the Tally Lamp])
- 4** Eyepiece Focus Ring
For adjusting the visibility.
- 5** Electronic Viewfinder
- 6** Eyepiece
Prevents external light from entering the viewfinder screen and cameraman's vision.
- 7** [USER1] Button (VF)
It can be assigned with a specific menu function.
Initial setting: VF Display
(☞ P45 [Assignment of Functions to User Buttons])
- 8** [USER2] Button (VF)
It can be assigned with a specific menu function.
Initial setting: Expanded Focus
(☞ P45 [Assignment of Functions to User Buttons])
- 9** Slide Stopper
Use it when mounting or unmounting the viewfinder.
- 10** [MIRROR] Switch
Flips the image.
L/R: Flips horizontally; OFF: Normal display; B/T: Flips vertically
- 11** [B.LIGHT] Switch
For configuring the brightness of the viewfinder.
H: Bright; N: Normal; L: Dark
- 12** [ZEBRA] Switch
Displays the zebra pattern.
ON: Turns on zebra pattern; OFF: Turns off zebra pattern; MOMENT: "Turns on zebra pattern" for a specific time interval while the switch is being pressed.
- 13** [TALLY] Front Tally Switch
For configuring the front tally lamp.
HIGH: Bright; OFF: Light off; LOW: Dark
(☞ P46 [Tally Lamp])
(☞ P242 [Blinking of the Tally Lamp])
- 14** [BRIGHT] Knob
For adjusting the brightness of the viewfinder.
- 15** [CONTRAST] Knob
For adjusting the contrast of the viewfinder.
- 16** [CHROMA] Knob
For adjusting the color of the viewfinder.
- 17** [PEAKING] Knob
For adjusting the outline of the viewfinder.

Basic System Diagram

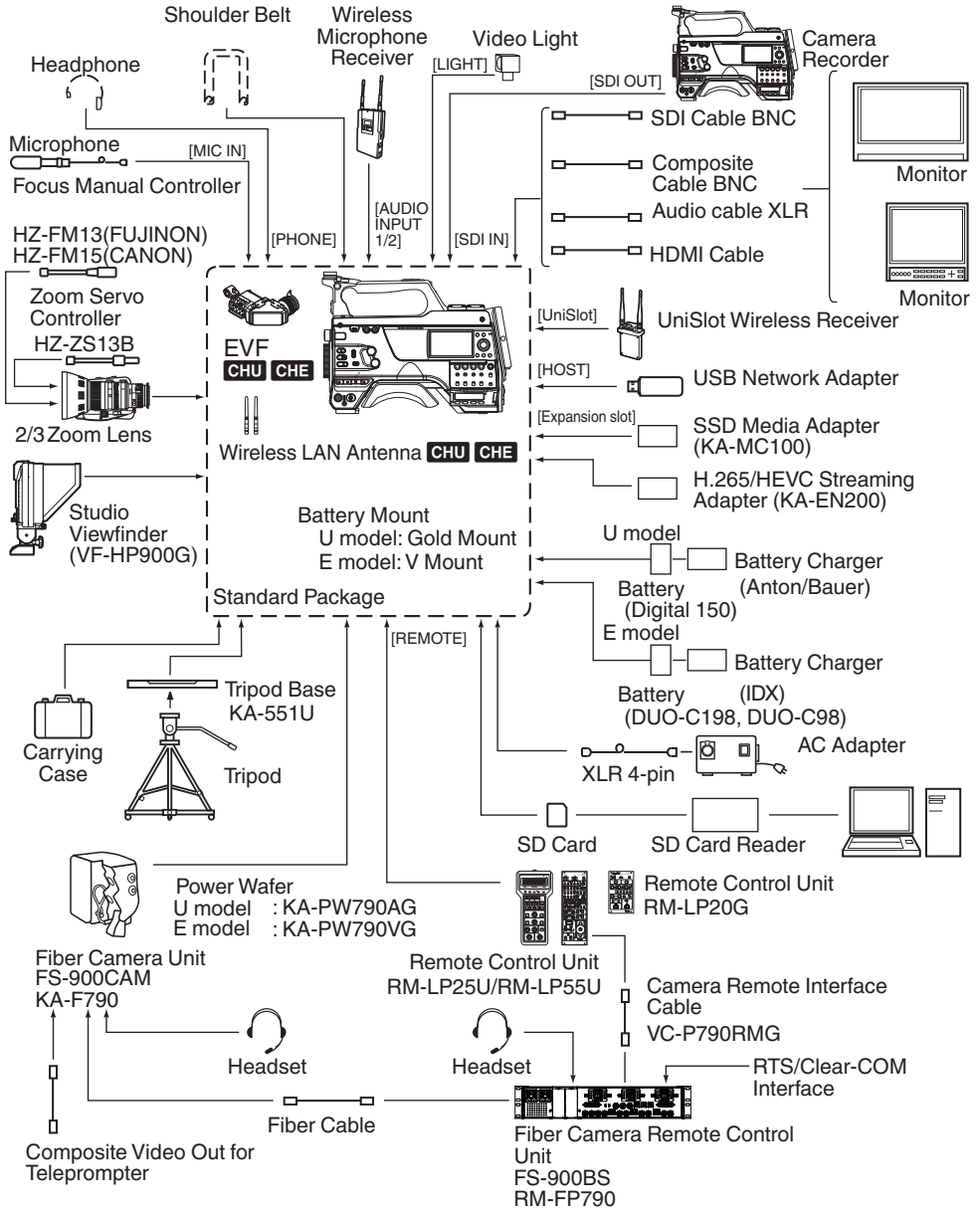

Settings and Adjustments Before Use

Attaching the Viewfinder (Supplied)

CHU CHE

Attaching the Lens (Sold Separately)

This camera recorder can be attached with a B4 mount lens.

Caution :

- Check that the camera recorder is turned off before attaching the lens. Attaching the lens with the power turned on can result in accident and malfunction.
- When detaching the lens, do not touch the optical filter or allow dust to adhere to the optical filter.

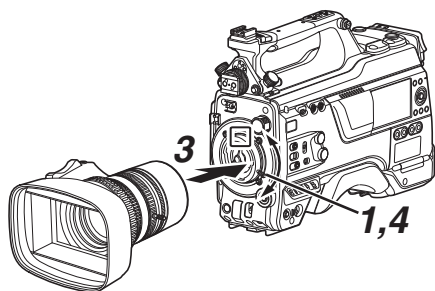

- 1 Loosen the lens lock lever.
- 2 Detach the body cap.
 - Do not lose the body cap, keep it properly.
- 3 Attach the zoom lens such that the pin matches the hole of the mounting area.
- 4 Tighten the lens lock lever.
- 5 Connect the lens cable to the [LENS] terminal.
- 6 Attach the lens cable to the clamp.

Memo :

- Tighten the lens lock lever completely. If it is not fully tightened, the lens may drop or the back focus may be out of alignment.
- For details on the lens, please refer to the "INSTRUCTIONS" of the lens used.
- It is necessary to adjust the back focus before use.
(☞ P44 [Adjusting the Back Focus])

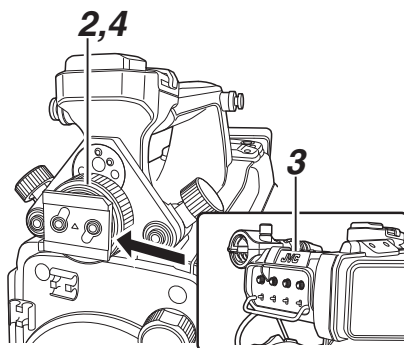

- 1 Set the [POWER ON/OFF] switch of the camera recorder to "OFF".
- 2 Loosen the viewfinder left-right position lock ring.
- 3 Slide the viewfinder in the direction of the arrow to attach it.

Memo :

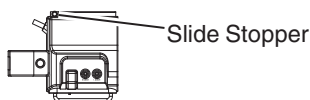

- To detach the viewfinder, pull the slide stopper up and slide it in opposite direction of the arrow.
- 4 Turn the viewfinder left-right position lock ring to secure the position of the viewfinder.
 - 5 Attach the viewfinder cable to the [VF] terminal.
 - 6 Pin the viewfinder cable to the clamp.

Attaching the Microphone (Sold Separately)

You can attach a separately sold microphone to the microphone holder.

The microphone that is sold separately uses a phantom power supply.

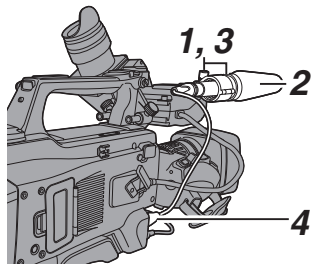

- 1 Turn the knob on the microphone holder counterclockwise to loosen and open the microphone holder.
- 2 Place the microphone in the microphone holder.
- 3 Turn the knob on the microphone holder clockwise to secure the microphone.
- 4 Connect the microphone cable to the [MIC IN] terminal.
- 5 Pin the microphone cable to the clamp.
- 6 Perform the settings for the phantom mic correctly.
(P71 [Audio Recording])

Attaching the Video Light (Sold Separately)

Video lights or accessories can be attached to the accessory shoe of this camera recorder.

The accessory shoe is of the 1/4-inch screw type. To make use of a slide shoe, attach the supplied cold shoe unit.

Attaching the Cold Shoe Unit

- 1 Remove the plate from the cold shoe unit. While lifting the catch, slide the plate out.

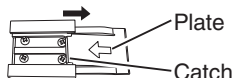

- 2 Attach the cold shoe unit to the shoe of this camera recorder using the four screws supplied.
- 3 Attach the plate to the cold shoe unit. Push the catch up from the bottom and slot the plate into the guide in the direction of the arrow.

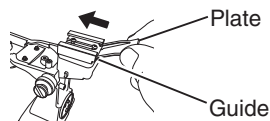

Attaching the Video Light

The [LIGHT] terminal (D-tap) of this camera recorder can be connected with a video light (DC 12 V, maximum power consumption 50 W **CHU** **STU** **RCHE** and DC 12V, 2A **CHE**).

Connect the [LIGHT] terminal after attaching the accessory shoe.

When the [LIGHT] switch is set to "AUTO", the light goes on only during recording in tandem with the camera. When it is set to "MANUAL", the light goes on or turns off respectively when the video light power is turned on or off.

Attaching the Wireless LAN Antennas (Supplied) **CHU** **CHE**

Attach the wireless LAN antenna by turning it in the clockwise direction. Hold the base while attaching the antenna.

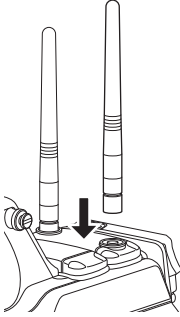

Caution : _____

- Applying force to the wireless LAN antenna or yanking it may damage the antenna so please use caution when using the antenna.
If it is damaged, replacement is chargeable even during the warranty period.
(Part number: T9A-0095-00)
- Use the antenna holders without removing them.

Attaching the Tripod (Sold Separately)

Mount this camera recorder after attaching the KA-551U tripod base unit (sold separately) to the tripod.

To prevent the camera recorder from falling off, which may result in injuries or damages, read the "INSTRUCTIONS" of KA-551U as well as that of the tripod to be used to attach the camera recorder securely.

Caution : _____

- If the camera recorder exceeds the weight limit of the tripod, do not mount it on the tripod.
- Use the tripod on a stable surface.

Adjusting the Position of the Shoulder Pad

Adjust the position of the shoulder pad back and forth.

- 1 Release the lock of the lock lever and adjust the position of the shoulder pad back and forth.
- 2 Lock the lock lever and check that the shoulder pad is fixed.



Power Supply

To use this camera recorder, you can attach a battery pack or connect an AC adapter to it.

(☞ P34 [Using a Battery Pack])

(☞ P33 [Using AC Power (DC IN Power)])

Caution :

- Set the [POWER ON/OFF] switch to "OFF" before changing the power supply that operates this camera recorder.
- Use the camera recorder and peripheral equipments within the rated output of the AC adapter.
- To connect other peripheral equipment, do so under the following conditions.
 - Keep the total power consumption of the peripheral equipments under 35 W when using the recommended battery.
 - Keep the total power consumption of the peripheral equipments under 65 W when using Tandem 150 (recommended AC adapter). **CHU STU**
 - Keep the total power consumption of the peripheral equipments under 50 W when using AC-100 (recommended AC adapter). **RCHE**
- The power consumption of the [LIGHT] terminal is below 50 W. Keep the total power consumption of the peripheral equipments excluding the [LIGHT] terminal under 35 W when using the terminal. If the total power consumption of the peripheral equipments exceeds the rating, the power to the [LIGHT], [DC OUT] (rear) and [DC OUT] (LAN) terminals is automatically cut off. This is not a malfunction. Use peripheral equipments with lower power consumption then turn on the power of this camera recorder again. **CHU STU RCHE**
- To check the power consumption, refer to the Power screen of the Status screen. (☞ P180 [Power Screen])
- If the voltage of the [DC INPUT] becomes 12 V or less, the USB adapter connected to the [HOST] terminal cannot be used. Check the power supply and the peripheral equipments, and turn on the power of this camera recorder again.
- Use a power supply of 12 V/ 2A or below for the [LIGHT] terminal.
The [LIGHT] terminal, DC OUT terminal (rear)/DC OUT (LAN) terminal and the D-tap terminal of the battery loading folder cannot be used at the same time. **CHE**

Using AC Power (DC IN Power)

Use the AC adapter (sold separately) to operate the camera recorder with AC power.

Recommended AC Adapter

CHU STU : Tandem 150 (Anton/Bauer)

CHE : IA-300a (IDX)

RCHE : AC-100 (IDX)

Memo :

- For the type of AC adapter to be attached on a battery mount, check the method of attachment in [Using a Battery Pack] (☞ P 34).

Attaching Core Filter Beforehand **CHE**

Attach the core filter (large) to the DC cable of the AC adapter before using the AC adapter.

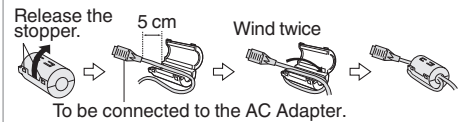

1 Connect the DC cable of the AC adapter to the [DC INPUT] terminal of the camera recorder.

Check that the power of this unit and that of the AC adapter are both set to "OFF", followed by connecting according to the diagram.

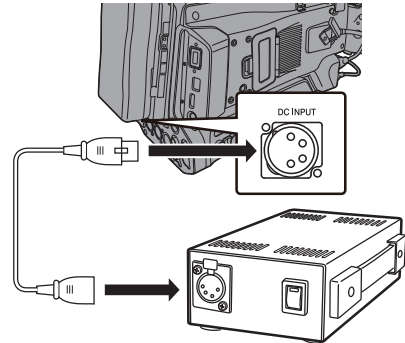

2 Turn on the power of the AC adapter, followed by setting the [POWER ON/OFF] switch of this unit to "ON".

Power will be supplied to the camera recorder.

Caution :

- Do not insert or remove the DC cable during recording.
- Do not use power supply of high voltage fluctuation, containing noise such as ripple, or with insufficient capacity.

Using a Battery Pack

Recommended Batteries

U model : Digital 150 (Anton/Bauer)

E model : DUO-C198, DUO-C98 (IDX)

* Models with an E suffix are for the European market and the UL Listing mark is not applicable.

Caution : _____

- Make use of the recommended batteries. Heavy batteries may fall off if not used correctly.
- For details on how to charge the battery, please refer to the "INSTRUCTIONS" of the battery in use.

Battery Operating Time

The following are the approximate times for continuous operation on fully-charged batteries.

Battery	Continuous Recording Time (At 25 °C)
Digital 150 (U model)	Approx. 3.1 hrs
DUO-C198 (E model)	Approx. 4.0 hours
DUO-C98 (E model)	Approx. 2.0 hours

Memo : _____

- Actual operating times may differ depending on the age of the battery, charging condition, and operating environment.
- Operating time is shortened in cold environment.
- The operating time may shorten when power zoom is used, accessories are connected, or when the LCD monitor is frequently used.

Precautions for the Battery Operation

- Do not remove the battery when the [POWER ON/OFF] switch is "ON".
- Do not insert or remove the DC cable when the battery is in use.
- Leaving the camera recorder unused with the battery attached will deplete the battery power even when you set the [POWER ON/OFF] switch to "OFF". Remove the battery if you are not using the camera recorder.

Attaching/Detaching the Battery (U Model)

Use the following battery type.

- Gold Mount

- 1 **Align the battery guide pins (x3) with the battery adapter guide hole, and insert them directly.**

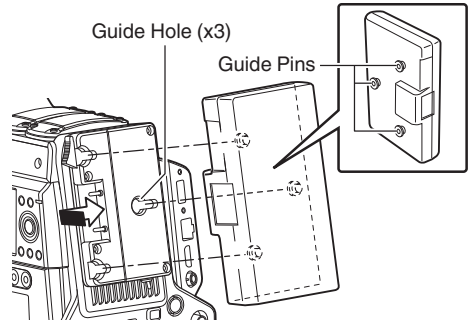

- 2 **Slide the battery in the direction indicated by the arrow until a "click" sound is heard.**

Memo : _____

- If the guide pins are not inserted straight, the battery will not be attached correctly.

- 3 **Detaching the Battery**

Press down the release lever and slide the battery toward you to detach it from the camera recorder.

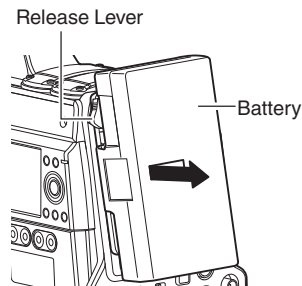

Attaching/Detaching the Battery (E Model)

Use the following battery type.

- V Mount

1 Attach the battery.

Face the terminal downward and attach the V mount of the battery onto the V mount attachment bracket of the camera recorder.

2 Press down the battery until it snaps into place.

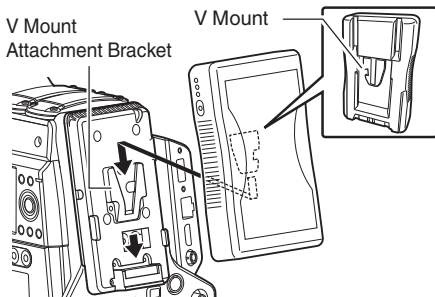

3 Detaching the Battery

Press down the release lever and slide the battery upward to detach it from the camera recorder.

Release Button

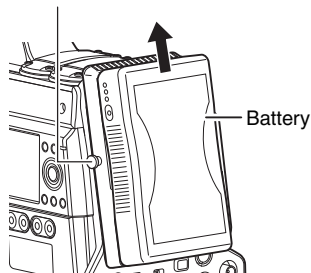

Precautions for Batteries

- Store the battery in a cool and dry place when not in use. Do not expose the battery to high temperatures (such as in a car under direct sunlight). This will cause battery leakage and shorten the battery life.
- Operating time is shortened if the battery terminal is dirty.
- If the operating time shortens drastically even after charging, the battery may be reaching the end of its life. Replace the battery with a new one.

Battery Warning Settings

Follow the steps below to configure the warning voltage or warning level when the remaining battery level is running low.

1 Select "Voltage" or "Capacity%" in [System] → [Battery] → [Type]

- "Near End (V)" and "End (V)" are enabled when "Voltage" is selected.
- "Near End (%)" and "End (%)" are enabled when "Capacity%" is selected.

2 Configure "Near End" and "End"

- Configures the setting at which the power is shut down automatically after the warning is activated.

(P158 [Near End (V)])

(P158 [End (V)])

(P158 [Near End (%)])

(P158 [End (%)])

3 Check in advance to ensure that the connected battery is in order and the settings are appropriate

- If the time is different from what has been anticipated, repeat the steps in 2 and 3.

Memo : _____

- When the battery that is connected does not support communication, "Near End (V)" and "End (%)" are enabled even when "Capacity%" is selected.

Power Status Display

Viewfinder Screen and LCD Monitor

The power status is displayed on the display and menu screens.

Display	Description
14.4V	Currently powered by a battery. When the battery power runs out, the battery mark appears hollow, and "RES" (yellow) is displayed. Memo : _____ <ul style="list-style-type: none"> You can set the display using [LCD/VF] → [Display Type] → [Battery]. (☞ P132 [Battery])
100min	
30%	
RES	
	Currently powered by DC power.
	A warning display when the supply voltage of the DC power is low.

Memo : _____

- The battery mark that indicates the battery level may not appear depending on the battery in use.
- When the battery that is connected does not support communication, the voltage is displayed regardless of the setting.

Display Screen

- (☞ P170 [Display Screen in Camera Mode])
- (☞ P176 [Display Screen in Media Mode])

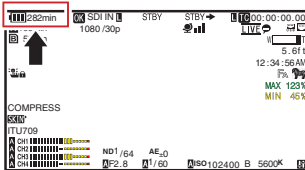

Menu Screen

(☞ P108 [Display and Description of the Menu Screen])

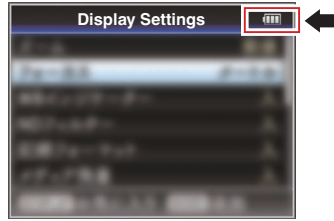

Warnings by Lamp and Warning Tone

Warning status is indicated by tally lamp and warning tone.

- The front and back tally lamps of the camera recorder appear blinking.
- The warning tone is output from the speaker or [PHONE] terminal.
Adjust the volume level using the [ALARM] volume adjustment knob.

Memo : _____

- If you continue to use the camera recorder while the power warning is displayed, the camera recorder will stop automatically when the battery or supplied voltage from the DC power becomes lower.

Caution : _____

- The remaining battery power and time are displayed as they are from the battery information. Accurate data may not be displayed depending on the battery condition. Replace the battery as soon as possible when the remaining battery power and time are low.

Turning On/Off the Power

Turning On the Power

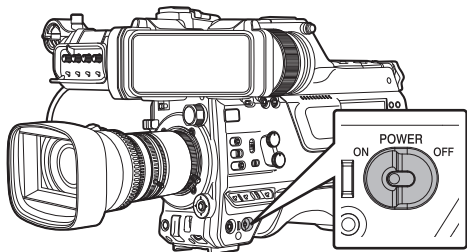

- 1 Set the [POWER ON/OFF] switch to "ON".
The camera recorder starts up in Camera mode and is ready for shooting.

Memo : _____

- The camera recorder always start up in Camera mode when the [POWER ON/OFF] switch is set to "ON". Use the [CAM/MEDIA] button at the side of the camera recorder to switch mode.
(P20 [Operation Modes])

Turning Off the Power

Sets the camera recorder to the recording standby or stop mode.

- 1 Set the [POWER ON/OFF] switch to "OFF".
- 2 Remove the battery and the power to the [DC INPUT] terminal (when not in use for a long time).

Caution : _____

- Do not set the [POWER ON/OFF] switch to "OFF" during recording. Check that the operation mode display is "STBY" or "STOP" before you turn off the power.
- If you have mistakenly set the [POWER ON/OFF] switch to "OFF" during recording, wait for 5 seconds or more before you turn on the power again.
- When turning off the power, first set the [POWER ON/OFF] switch of the camera recorder to "OFF". Do not remove the battery or turn off the AC power while the [POWER ON/OFF] switch is set to "ON".

Initial Settings

When the power is first turned on, the Initial Setting screen for performing the initial settings in the camera recorder appears.

Set the date/time of the built-in clock in the [Date/Time] screen.

All operations are disabled until initial settings are complete.

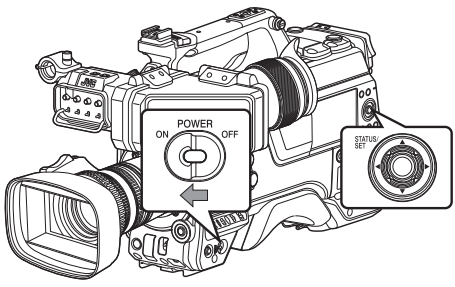

Memo : _____

- It is recommended to use the AC adapter as the power supply.
- Attach the lens cap.

1 Set the [POWER ON/OFF] switch to "ON".

A language selection screen appears.

- For U models

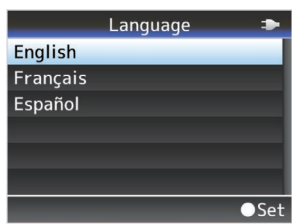

- For E models



Memo : _____

- The menus and messages on the screen of the LCD monitor or viewfinder are displayed in the selected language.

2 Select a language using the cross-shaped button (▲▼), and press the [STATUS/SET] button (●).

A self-diagnosis screen appears.

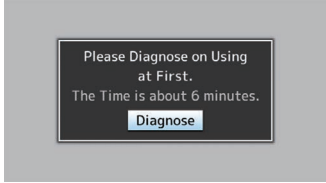

3 Ensure the lens cap is attached, and press the [STATUS/SET] button (●).

- Self-diagnosis starts.
- A progress bar appears, and "Complete Diagnosis" appears when the diagnosis is complete.

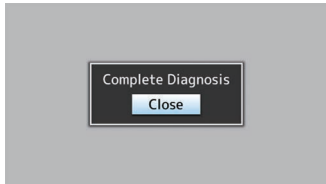
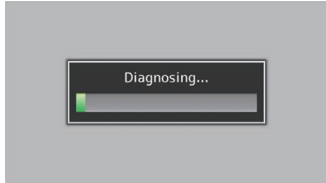

Memo : _____

- It takes about 6 minutes to complete the diagnosis. During the diagnosis, do not operate or turn off the camera recorder.

4 Press the [STATUS/SET] button (●) after confirming the exit screen.

The [Date/Time] screen appears.

- For U models

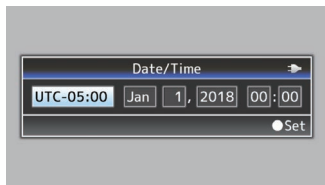

- For E models

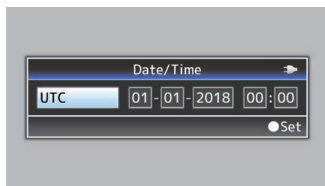

5 Set the time zone and date/time.

- ① Move the cursor with the cross-shaped button (◀▶) and select the setting item.
 - ② Change the values with the cross-shaped button (▲▼).
- 6 Press the [STATUS/SET] button (●) after setting is complete.
The clock is set to 0 seconds of the input date/time.

Memo : _____

- The configured date/time data can be displayed on the LCD monitor and viewfinder screen and be recorded to a recording media.
- The value of the year can be set in the range of “2000” to “2099”.
- The configured date/time data is saved in the built-in battery even if the power is turned off.
- If the date/time data is no longer retained, the built-in battery is dead. For replacement of the built-in battery, please contact the local dealers in your area.

Changing the Time after Initial Setting

Setting the Date/Time

(☞ P158 [Date/Time])

- 1 Select [System] → [Date/Time].
The [Date/Time] screen appears.
- 2 Set the date and time.
 - ① Move the cursor with the cross-shaped button (◀▶) and select the setting item.
 - ② Change the values with the cross-shaped button (▲▼).
- 3 Press the Set button (●) after setting is complete.
The clock is set to 0 seconds of the input date/time.

Changing the Display Style

You can change the display style of the date/time on the menu.

Setting the Date Display (Date Style)

(☞ P159 [Date Style])

The date display can be changed in [System] → [Date Style].

Setting the Time Display (Time Style)

(☞ P159 [Time Style])

The time display can be changed in [System] → [Time Style].

Date/Time Display in Each Operation Mode

During Camera mode:

Time of the built-in clock is displayed.

During Media mode:

Shooting date/time of the clip being played back is displayed.

Displays on the LCD Monitor and Viewfinder

You can display the camera status, recording media information, zebra pattern, and various markers in the video image on the LCD monitor and viewfinder screen during shooting.

- Memo : _____
- When [A/V Set] → [Video Set] → [SDI OUT2]/[HDMI OUT]/[VIDEO OUT] → [Character] is set to “On”, the display screen and menu screen are also displayed in the video image of the video signal output terminal.
 - (P134 [Character (SDI OUT2)])
 - (P136 [Character (HDMI OUT)])
 - (P137 [Character (VIDEO OUT)])

Display Screen

Display Screen (VF/LCD) in Camera Mode

- (P170 [Display Screen in Camera Mode])
- Use the [DISPLAY] button to switch the display mode of the LCD monitor.
(Display off → Display on → Enlarged display → Display off)
- Use the user button that is assigned with “VF Display” to switch the viewfinder screen.
(Display off → Display on → Display off)
- Press the [STATUS/SET] button to switch to the status screen.

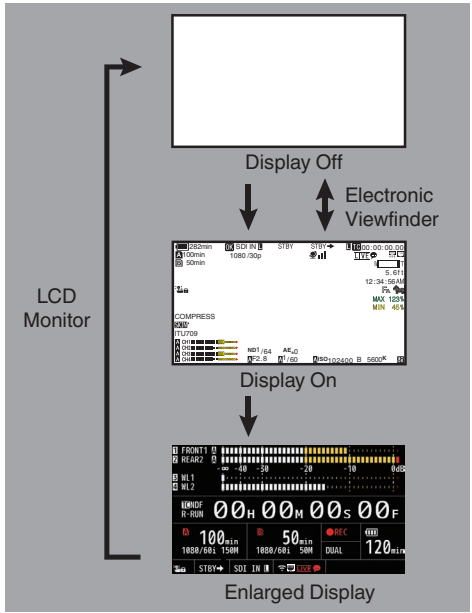

Display Screen (VF/LCD) in Media Mode

- (P176 [Display Screen in Media Mode])
- This is the screen display during clip playback in Media Mode.
- The display switches with every press of the [DISPLAY] button.
(Display off → Display on → Display off)

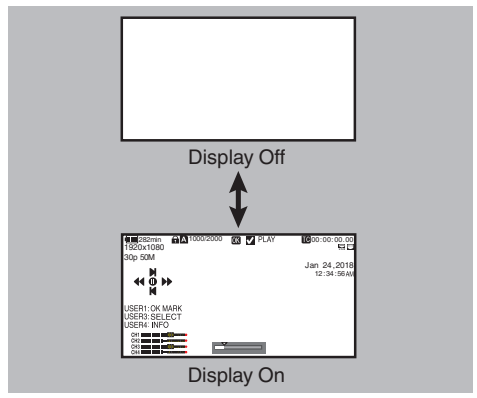

Status Screen

- This screen allows you to check the current settings.
- To display the status screen, press the [STATUS/SET] button in the normal screen.
- Press the [STATUS/SET] button to switch to the status screen.
- Press the [MENU/THUMB] button at each status screen (other than the [Camera] and [Power] screen) to enter the setting screen.
- Use the cross-shaped button (◀▶) to switch between the screens.

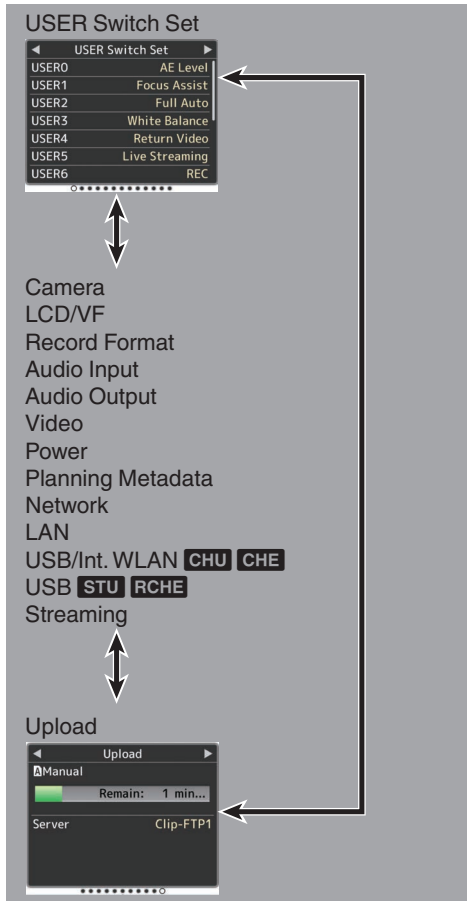

* These are screen examples. The contents displayed are different depending on the model and settings.

Remote Edit Mode Screen

This is a mode for accessing the page for editing the metadata that is recorded in a clip via a web browser on devices such as a smartphone, tablet terminal, or PC.

(☞ P206 [Clip Metadata])

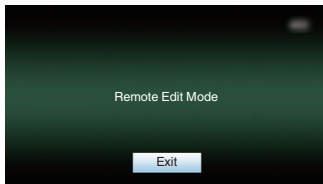

Warning Display

Warning display is displayed in the display screen (Camera mode, Media mode).

(☞ P237 [Error Messages and Actions])

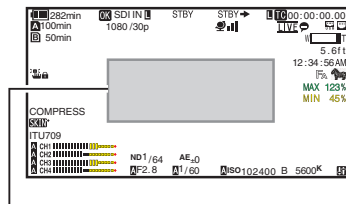

Warning Display Area

Adjusting the LCD Monitor and Viewfinder

You can monitor video images on this camera recorder using the viewfinder, LCD monitor, or both.

Adjusting the LCD Monitor

You can change the brightness of the LCD monitor according to your usage condition. Changing the brightness of the screen will not affect the recorded images.

Adjusting the Brightness

Use [LCD/VF] → [LCD Bright] to adjust the brightness of the LCD monitor.
(☞ P128 [LCD Bright])

Adjusting the Outline

Use [LCD/VF] → [LCD Peaking] to adjust the outline of the LCD monitor.
(☞ P128 [LCD Peaking])

Adjusting the Contrast

Use [LCD/VF] → [LCD Contrast] to adjust the contrast of the LCD monitor.
(☞ P128 [LCD Contrast])

Adjusting the LCD RGB Gain

Use [LCD/VF] → [LCD RGB Gain] to adjust the R/G/B gain of the LCD monitor.
(☞ P129 [LCD RGB Gain])

Configuring the Backlight

Configure the backlight using the [B.LIGHT] button located on the side operation panel.
Dark → Normal → Bright → Off → Dark

Adjusting the Viewfinder

You can change the brightness and peaking of the viewfinder screen according to your usage conditions.

Changing the brightness of the screen will not affect the recorded images.

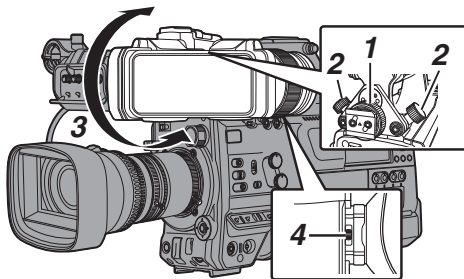

- 1 Loosen the fastening rings on the left and right sides of the viewfinder to adjust the horizontal position, followed by tightening the rings.**
- 2 Loosen the viewfinder front-back position lock ring. Adjust the front and back positions then tighten the ring.**
- 3 Adjust the angle of the viewfinder to a position that enables easy viewing.**
- 4 Adjust the visibility using the eyepiece focus ring.**
Adjust until the viewfinder image appears sharp.

5 Adjust the brightness, outline and contrast of the viewfinder screen.

Adjusting the Brightness

Use the [BRIGHT] knob to adjust the brightness of the viewfinder.

Adjusting the Outline

Use the [PEAKING] knob to adjust the outline of the viewfinder.

Adjusting the Contrast

Use the [CONTRAST] knob to adjust the contrast of the viewfinder.

Adjusting the Color

Use the [CHROMA] knob to adjust the color of the viewfinder.

Configuring the Luminance

Use the [B.LIGHT] switch to configure the luminance level.

H: Bright; N: Normal; L: Dark

Adjusting the VF RGB gain

Use [LCD/VF] → [VF RGB Gain] to adjust the R/G/B gain level of the viewfinder.

(P129 [VF RGB Gain])

Displaying in Black and White

The display can be switched to black-and-white by configuring [LCD/VF] → [VF Color] to "Off".

(P128 [VF Color])

Flipping up the Eyepiece

Flipping up the eyepiece provides a better view of the entire image.

Push the lock upward to flip up the eyepiece.

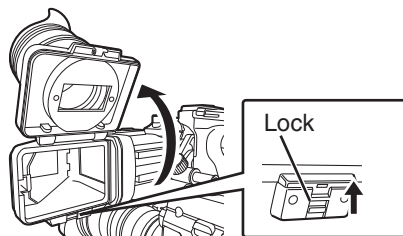

Flipping up the VF Barrel

Flipping up the viewfinder barrel enables viewing of the image directly. The image will be inverted in this case. Press the [MIRROR] switch to display the image correctly. Push the lock upward to flip up the viewfinder barrel.

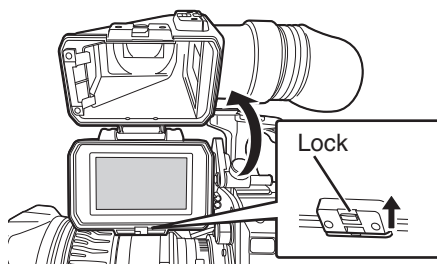

Adjusting the Back Focus

When the lens is attached for the first time, adjust the back focus of the lens if the focus is not clear when it is zoomed to the telephoto or wide-angle end.

- The Siemens Star Chart is most suitable as the subject.

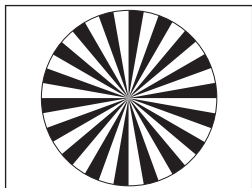

Siemens Star Chart

- 1 Place an object at approximately 3 m away from the camera recorder.
- 2 Open up the iris.
- 3 Set the lens to the telephoto end.
- 4 Turn the focusing ring to adjust the focus.
- 5 Set the lens to the wide-angle end.
- 6 Loosen the F.B. locking screw of the lens and turn the back focus adjustment ring to adjust the focus.
- 7 Repeat the steps from 3 to 6 to adjust the focus at both ends of the zoom.
- 8 After determining the position of the back focus adjustment ring, tighten the F.B. locking screw.

Memo : _____

- For details, please refer to the "INSTRUCTIONS" of the lens.

Assignment of Functions to User Buttons

You can assign functions to the following buttons and use them as user buttons. By assigning functions to the buttons, the usability of the camera recorder can be enhanced. Perform settings in the menu items corresponding to each button.

Button	Menu Item
[USER0] Switch	[USER0]
[USER1] Button	[USER1]
[USER2] Switch	[USER2]
[USER3] Button	[USER3]
[USER4] Button	[USER4]
[ONLINE/5] Button	[USER5]
[USER6] Button	[USER6]
[USER7] Button	[USER7]
[AWB/USER8] Switch	[USER8]
[▲] Button	[USER9 ▲]
[▼] Button	[USER10 ▼]
[◀] Button	[USER11 ◀]
[▶] Button	[USER12 ▶]
[SET/USER13] Button	[USER13 ●(Front)]
[USER1] Button (VF)	[USER1 (VF)]
[USER2] Button (VF)	[USER2 (VF)]
[RET] Button on the Lens	[LENS RET]

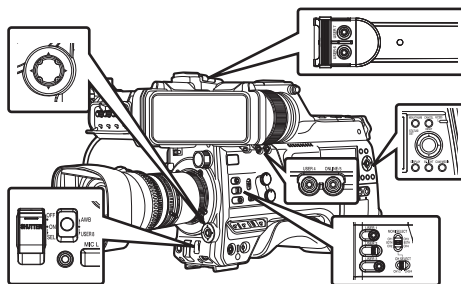

1 Assign functions to the buttons from the menu.

Configure each item to the user buttons in [Camera Function] → [User Switch Set].

(☞ P113 [User Switch Set Item])

Memo : _____

- Operations of the user buttons are interlocked with the menu settings.
- When the menu screen is displayed, these buttons function as the menu operation buttons. (☞ P107 [Basic Operations in Menu Screen])

Tally Lamp

This is the indicator lamp for recording and warning.
The operation changes according to the menu settings.

The lamp blinks when the battery or remaining space on the recording media is low. (Camera mode only)

* Configure in [System] → [Front Tally]/[Back Tally].

(P157 [Tally System])

(P157 [Front Tally/Back Tally])

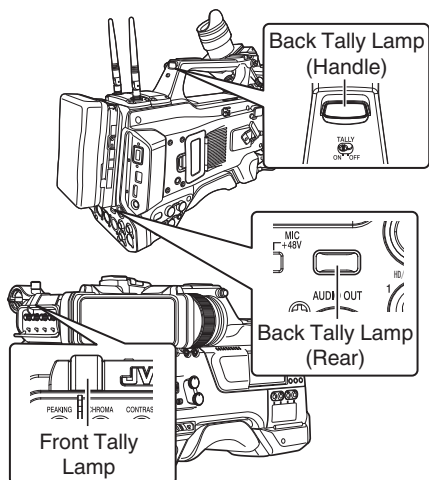

• When [Tally System] is set to “Internal”

Menu Setting	Front Tally/Back Tally		
	Rec	Live Streaming	Rec/Live Streaming
Information on Camera Recorder Functions	Warning	▲	
	Alarm	■	
Camera Recorder Recording Status	Recording	●	●
	Special Recording in Progress *1	●	●
Live Streaming Status	Live Streaming in Progress	-	●

• When [Tally System] is set to “Studio”

[TALLY] Switch	Front Tally/Back Tally	Front Tally	Back Tally
	OFF	HIGH or LOW	ON
Information on Camera Recorder Functions	Warning	-	▲
	Alarm	-	■
Input from Remote Control Unit	CALL	-	■*2
	PROGRAM	-	●
	PREVIEW	-	●

● : Lights up

▲ : Blinks four times in 1 second

■ : Blinks once in 1 second

*1 Paused state during special recording ([Clip Continuous]).

(P93 [Clip Continuous Rec])

*2 Back tally only

Memo : _____

• Blinking takes priority over lighting up.

Recording Media

This camera recorder saves recorded audio sound and videos except those in “HD EXT(SSD)” quality to the SD card (sold separately) in the card slot.

Audio sound and videos recorded in the “HD EXT(SSD)” mode will be saved to the SSD media (sold separately) in the KA-MC100 SSD Media Adapter (sold separately) that is inserted into the expansion slot.

Usable Cards

Format Setting and Usable SD Card Combinations

System	Format	Bit Rate	Usable SD Card
High-Speed	QuickTime (H.264)	4:2:2 HQ 70M (XHQ), 4:2:2 HQ 50M (XHQ), 50M (XHQ), 35M (UHQ)	UHS-I U3 or higher
HD		4:2:2 HQ 70M (XHQ), 4:2:2 HQ 50M (XHQ), 50M (XHQ) 35M (UHQ)	UHS-I U1 or higher, or Class 10 or higher
	QuickTime (MPEG2), MXF (MPEG2)	35M (HQ), 25M (SP)	UHS-I U1 or higher, or Class 6 or higher
	Exchange (U model) MP4 (H.264) (E model)	12M (LP), 8M (LP) 12M (LP), 8M (LP)	
SD	-	-	UHS-I U1 or higher, or Class 4 or higher
Web	-	-	

Caution :

- Using cards other than those from Panasonic, TOSHIBA or SanDisk may result in recording failure or data loss.

Usable SSD Media

Refer to the “Instruction Manual” of the SSD Media Adapter that is inserted into the expansion slot to mount a compatible SSD media.

Caution :

- Please refer to the product information page on our website for a list of SSD media that have been tested for compatibility.

Estimated Recordable Time of SD Cards

The estimated recordable time is only a guide. Differences may occur depending on the SD card in use and the battery condition.

- The recordable time varies according to the settings in [System], [AFormat], [AResolution], [ABit Rate] and [BResolution].
- The following is the recording time during audio 4ch recording. The recording time is longer for 2ch recording.
(☞ P160 [System])
(☞ P160 [AFormat/EXT Format])
(☞ P161 [AResolution/EXT Resolution])
(☞ P162 [ABit Rate/EXT Bit Rate])
(☞ P162 [B Resolution])

System	HD, HD + Web (HD)			SD, HD + Web (Web)	HD + Web (Web)	
Format	QuickTime (H.264)					
Resolution	1920x1080	1920x1080, 1280x720		720x480, 720x576	960x540	480x270
Bit Rate	XHQ (70M)	XHQ (50M)	UHQ	HQ	HQ	LP
8GB	12	17	24	80	240	480
16GB	24	35	48	160	480	960
32GB	48	70	96	320	960	1920
64GB*	96	140	192	640	1920	3840
128GB*	192	280	384	1280	3840	7680
256GB*	384	560	768	2560	7680	15360

(Unit: minute)

System	HD			
	QuickTime (MPEG2), MXF (MPEG2)		Exchange, MP4 (H.264)	
Resolution	1920x1080, 1440x1080, 1280x720	1440x1080	1920x1080	1280x720
Bit Rate	HQ	SP	LP (12M)	LP (8M)
8GB	24	32	80	120
16GB	48	64	160	240
32GB	96	130	320	480
64GB*	192	260	640	960
128GB*	384	520	1280	1920
256GB*	768	1040	2560	3840

(Unit: minute)

* SDXC

Memo : _____

- If the SD card contains files recorded by devices other than this camera recorder or files that are saved from a PC, the recordable time may be shorter or data may not be properly recorded.
- For each file format, up to 600 clips can be recorded to one SD card on this camera recorder. When 600 clips are recorded to one card, the remaining space is displayed as 0 min regardless of the estimated recordable time, and no further recording can be performed.
- When [System] is configured to “High-Speed”, the remaining time display for recording to the SD card will run out faster than usual.

Write-Protect Switch on the SD Card

- ① Slide the write-protect switch upward to enable writing or deleting.
- ② Slide the write-protect switch downward to prevent writing or deleting. (Images in the card are protected.)

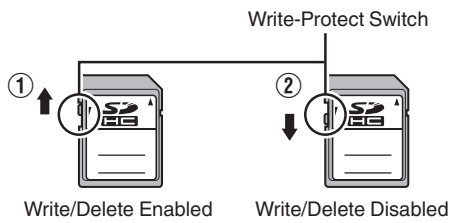

Estimated Recordable Time of SSD Media

The estimated recordable time is only a guide. Differences may occur depending on the SSD media in use and condition of the battery.

- The recordable time varies according to the settings in [System], [EXT] Frame Rate], and [EXT] Bit Rate].

System	HD EXT (SSD)		
	ProRes		
Resolution	1920x1080		
Bit Rate	422		
Frame Rate	30p	25p	24p
500 GB	Approx. 390 mins.	Approx. 470 mins.	Approx. 490 mins.
1 TB	Approx. 780 mins.	Approx. 940 mins.	Approx. 980 mins.
2 TB	Approx. 1600 mins.	Approx. 1900 mins.	Approx. 2000 mins.

Memo : _____

- The maximum continuous recording time of “HD EXT(SSD)” is 4 hours. Recording stops upon exceeding 4 hours.

Inserting an SD Card

This camera recorder comes with two card slots (Slot A and B) for video/audio recording and playback.

- 1 **Press the SD card cover knob to open the cover.**
- 2 **Insert an SD card with the notched corner pointing up.**
The status indicator of the card slot to which the card was inserted lights up in red.
- 3 **Close the SD card cover.**

Card Slot Status Indicator

The following table shows the respective states of slot A and B.

Lamp	Slot Status
Lights up in red	The inserted SD card is being accessed. (writing/reading data) Do not turn off the power of the camera recorder or remove the SD card.
Lights up in green	On standby. The inserted SD card can be used for recording or playback.
Light goes out	<ul style="list-style-type: none"> • SD card is not inserted. • An unusable card is inserted. • An SD card is inserted but a different slot is selected.

Removing the SD Card

- 1 **Check that the SD card to be removed is not being accessed (status indicator of the card slot lights up in red).**
- 2 **Press the SD card cover knob to open the cover.**
- 3 **Push the SD card and remove it from the slot.**
- 4 **Close the SD card cover.**

Memo : _____

- When both slots are inserted with usable SD cards, the previously selected slot is used.

Caution : _____

- Data may be lost if you turn off the power of the camera recorder or remove the SD card when it is being accessed. All data recorded on the card, including the file that is being accessed, may be corrupted. Be sure to check whether the status indicator is lit in green or turned off before you turn off the power or remove the SD card.
- If you mistakenly remove the card when it is being accessed, reinsert the card only after the status indicator goes off.
- The SD card may not be recognized if you insert and remove the card within a short time. When this happens, remove the card and wait for a few seconds before you reinsert.

Switching the SD cards

When both card slots are inserted with SD cards, you can use the [SLOT SELECT] button to switch the card to use.

When the memory on an SD card is full during recording, data recording automatically switches to the other card.

Memo : _____

- The [SLOT SELECT] button is disabled during recording or playback. Cards will not be switched even if you press the button.

Inserting the SSD Media Adapter (Sold Separately)

This unit is equipped with an [expansion slot] for recording and playing back video and audio in the “HD EXT(SSD)” mode.

- 1 Turn off the camera recorder.
- 2 Remove the wireless LAN antennas. **CHU**
CHE
- 3 Loosen the 4 screws of the expansion slot and remove the cover.

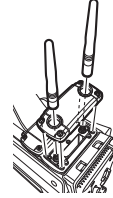

- 4 Mount KA-MC100.

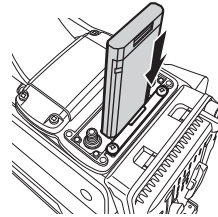

- 5 Fasten the 4 screws on the cover of the expansion slot.
- 6 Attach the wireless LAN antennas. **CHU**
CHE
- 7 Turn on the camera recorder.

Memo : _____

Refer to the instruction manual of the KA-EN200 when attaching the “KA-EN200” H.265/HEVC Streaming Adapter (sold separately).

Formatting (Initializing) of Recording Media

When any of the following recording media (SD card or SSD media) is inserted, [! FORMAT] appears in the remaining level display area.

Format the card using the camera recorder menu.

- Unformatted recording media
- Recording media formatted under different specifications

* For details of the menu operation, refer to “[Basic Operations in Menu Screen] (P 107)”.

Caution :

- Be sure to format the recording media on this camera recorder. Recording media formatted on a PC or other peripheral equipment cannot be used on this camera recorder.
- [! RESTORE] appears in the remaining level display area when a recording media that requires repair is inserted.

1 Select [System] → [Media] → [Format Media].

(P 157 [Format Media])

Memo :

- [Media Format **EXT**] can be selected in the following cases.
 - [System] is set to “HD EXT(SSD)”
 - [Slot Mode] is set to “Backup **EXT**”

2 Select the slot of the card to be formatted and press the [STATUS/SET] button (●).

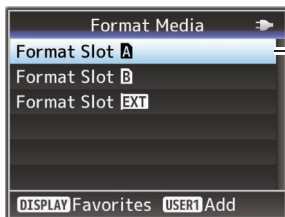

3 The status of the selected recording media is displayed.

4 Select [Format] and press the [STATUS/SET] button (●).

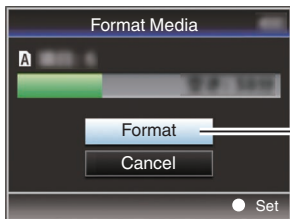

5 Formatting starts.

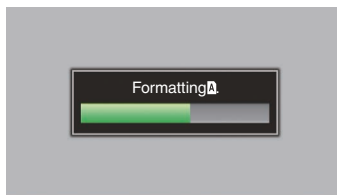

6 Formatting is complete.

When formatting is complete, “Complete” appears and the camera recorder returns to the [Format Media] screen.

Memo :

- The menu cannot be operated while formatting is in progress, but recording is possible to the slot where formatting is not executed.
- Formatting cannot be performed in the following cases.
 - When recording to the recording media to be formatted is in progress.
 - Recording media is not inserted.
 - Write-protect switch of the SD card is set (🔒 is displayed).

Caution :

- If you format a recording media, all data recorded to it, including video data and setup files, will be deleted.

Repairing the Recording Media

It is necessary to restore the recording media if an abnormality occurs to the data in the recording media due to some reasons.

Memo : _____

- [! RESTORE] appears in the remaining level display area when a recording media that requires repair is inserted.

- 1 Select [System] → [Media] → [Restore Media].
(☰ P157 [Restore Media])
- 2 Select the recording media to be restored and press the [STATUS/SET] button (●).

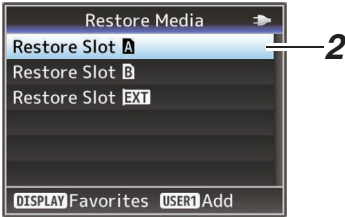

- 3 Restoring starts.

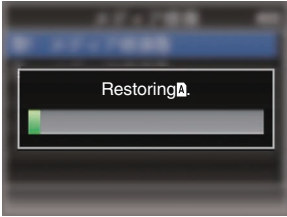

4 Restoring is complete.

- When restoring is complete, “Complete” appears and the camera recorder returns to the [Restore Media] screen.
- When no media that requires restoring is inserted, the camera recorder returns to the [Media] menu screen.

Caution : _____

- [Restore Media] can only be selected in Camera mode. However, it cannot be selected while the camera recorder is recording. Select [Restore Media] in Camera mode when the camera recorder is not recording.
- [Restore Media] does not restore the recording media to its original states completely. If restoring fails, replace or format the recording media. Take note that formatting erases all the information inside the recording media.
- Restoring cannot be performed in the following cases.
 - Camera recorder is recording in progress.
 - Recording media is not inserted.
 - Write-protect switch of the SD card is set (🔒 is displayed).

Clips Recorded to Recording Media

Folders Created in the Recording Media

The captured image is recorded into different folders according to the [Format] settings.

- Other than MXF (MPEG2): [DCIM]
- MXF (MPEG2): [PRIVATE]

Memo : _____

- By formatting (initializing) the recording media from the [Format Media] menu on the camera recorder, folders required for recording in the current [System] settings will be generated.
- When the [System] settings and [AFormat]/ [BFormat] settings are changed, folders required for recording in those settings will be automatically generated.

Caution : _____

- When a clip inside the folder is moved or deleted using the Explorer (Windows) or Finder (Mac), recording to the recording media may fail if formatting (initializing) of the media is not performed.

Clip (Recorded Data) and Clip Name

- When recording is stopped, the images, audio and accompanying data which are recorded from start to stop are recorded as one "clip" on the SD card.
- An 8-character clip name is automatically generated for the recorded clip. ("Clip Name Prefix" + "Clip Number")

Example: QuickTime

ABCG0001

Clip Number

A number in automatic ascending order is assigned in the recording order.

The Clip Number can be reset in the menu.*

Clip Name Prefix (any four alphanumeric characters)

This is set to "xxxG" ("xxx" denotes the last 3 digits of the serial number) by default.

- * [Clip Set] → [Reset Clip Number]
(☞ P165 [Reset Clip Number])

Memo : _____

- Before recording starts, you can set any characters for the clip name prefix by using [System] → [Record Set] → [Clip Set] → [Clip Name Prefix].
(☞ P165 [Clip Name Prefix])
- Changes cannot be made after recording.

Recorded Clips

- The recorded materials may be split into several files but they can be played back continuously on the camera recorder.
- Clips may be recorded across the two SD cards in card slots A and B depending on the recording time of the clip.

Caution : _____

- A clip recorded across several cards cannot be played back continuously. Continuous playback is only possible when the recording is made on one card.

Operation Lock Feature

You can use this feature to prevent erroneous camera operation.

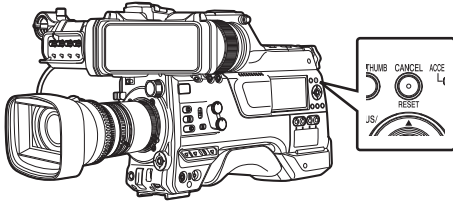

1 While in the Camera mode (when the display screen appears), press and hold the [CANCEL/RESET] button for 5 seconds or longer.

- The operation lock turns on, and an operation lock icon (🔒) appears on the display screen.
- Press the [CANCEL/RESET] button again for 5 seconds or longer to turn off the operation lock.

Memo : _____

- The operation lock feature is only valid in the Camera mode.
(📷 P20 [Operation Modes])
- The power turns off and the operation lock is disengaged.
- The following remote operations are possible even when the operation lock feature is turned on (“On”).
 - Operation from the remote control unit that is connected to the [REMOTE] terminal.
 - Remote operation of the camera through access via a browser on devices such as a smartphone, tablet terminal, or PC.

Operation lock does not apply to the following buttons and switches.

- [POWER ON/OFF] switch
- [ND FILTER] switch
- [MONI SELECT] switch
- [CH SELECT] switch
- [AUDIO INPUT CH1/2/3/4] recording level adjustment knob
- [AUDIO SELECT CH1/2/3/4]-[MANUAL/AUTO] selection switch
- [AUDIO SELECT CH1/2/3/4]-[FRONT/REAR/WIRELESS] selection switch
- [TC PRESET] button
- [TC GEN] time code generator switch
- [MONITOR] volume adjustment knob
- [ALARM] volume adjustment knob
- [REC] button
- User button assigned with the [Rec] function
- All switches on the lens
 - [PEAKING][BRIGHT][CONTRAST][CHROMA] Knob
 - [MIRROR][TALLY] Switch

Basic Shooting Procedures

Preparations

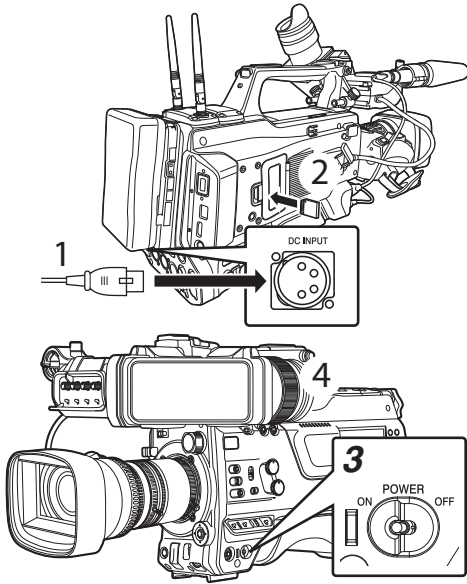

1 Supply battery or AC adapter power to the camera recorder.

(☞ P33 [Power Supply])

2 Insert the recording media.

(☞ P47 [Recording Media])

3 Turn on the power of the camera recorder.

Setting the [POWER ON/OFF] switch to “ON” starts up the camera recorder in the Camera mode to enable shooting.

4 Adjust the angle of the viewfinder.

(☞ P42 [Adjusting the LCD Monitor and Viewfinder])

5 Set [System], [Format], [Resolution], [Frame Rate], [Bit Rate] and [Audio] in [System] → [Record Set] → [Record Format].

- You can select the definition of the recorded videos, file format for recording/playback, and the video recording format on this camera recorder.
- Press the [MENU/THUMB] button to display the menu screen on the LCD monitor and viewfinder.

Shooting

1 Configure the video and audio input settings.

You have to configure video settings such as brightness adjustment (iris, gain, shutter) and white balance adjustment in order to start shooting. You also have to adjust the audio input settings and audio recording level for audio recording.

- Adjusting the Brightness
- Adjusting the White Balance
- Adjusting Audio Input Settings and Recording Level

2 Press the [REC] button to start recording to the recording media.

The tally lamp lights up in red during recording.

- Zoom Operation (☞ P59 [Zoom Operation])
- Adjusting the Focus (☞ P59 [Focus Operation])

Memo : _____

- If both the slots are loaded with recordable cards in the factory default, pressing the [REC] button starts recording only to the media in the selected slot.

When [System] → [Record Set] → [Slot Mode] is set to “Dual”, recording can be performed simultaneously to the cards in both the slots.

(☞ P88 [Dual Rec])

- The tally lamp can be turned off by setting the [TALLY] switch to “OFF”.

3 Check the most recently captured images.

- Press the user button that is assigned with the Clip Review function. Doing so activates the function and plays back the most recently captured images on the LCD monitor and viewfinder screen.
- After playback, the camera recorder returns to standby mode (STBY).

(☞ P86 [Viewing Recorded Videos Immediately (Clip Review)])

Selecting System Definition, File Format and Video Format

You can select the definition of the recorded videos, file format for recording/playback, and the video recording format on this camera recorder.

Setting the Record Format Menu

1 **Set [System], [Format], [Resolution], [Frame Rate] and [Bit Rate] in [System] → [Record Set] → [Record Format].**

2 **Set each of the items.**

- ① [Selecting a System Definition] (☞ P 56)
- ② [Selecting a File Format] (☞ P 57)
- ③ [Selecting a Video Format] (☞ P 57)
- ④ [Selecting the Aspect Ratio of SD Videos] (☞ P 58)

3 **After setting is complete for all items, press the [USER1] button.**

- The recording format is switched.
- A “Please Wait...” message appears on the screen during switching.

Selecting a System Definition

The following definitions are available for selection.

- **HD EXT:**
Records clips in the HD (High Definition) resolution (1920x1080)
- **HD:**
Records in HD (High Definition) resolution (1920x1080 or 1280x720)
- **SD:**
Records in SD (Standard Definition) resolution (720x480 or 720x576)
- **Web:**
Records in resolution (960x540, 720x480, 720x576, or 480x270) suitable for web distribution
- **High-Speed:**
Records in HD resolution (1920x1080)

You can select a definition for the recorded images from the following items under [System].

- **HD EXT(SSD):**
Records to the expansion slot in the HD EXT quality.
- **HD:**
Records in HD quality for both slots A and B.
- **SD:**
Records in SD quality for both slots A and B.
- **HD(SDI In):**
Records the HD SDI video of the device connected to the [HD/SD SDI IN] terminal in “HD” to both slot A and slot B.
- **SD(SDI In):**
Records the SD SDI video of the device connected to the [HD/SD SDI IN] terminal in “SD” to both slot A and slot B.
- **HD+Web:**
Records in HD quality for slot A, and Web quality for slot B.
(☞ P88 [Recording Simultaneously at Two Different Definitions])
- **High-Speed:**
Records in HD quality for both slots A and B.

Caution :

- When [System] → [Record Set] → [Record Format] → [System] is configured to “High-Speed”, network cannot be used via wireless LAN **CHU CHE** or the [HOST] terminal (USB). Configure as follows in this case.
 - Set [Network] → [Connection Setup] → [USB/Int. WLAN] to “Off”. **CHU CHE**
 - Unplug the USB network adapter
 Note that camera operation will come to an emergency stop and the power will turn off if the above steps are not performed. File data may be damaged if this happens while recording is in progress.

Selecting a File Format

Select a file format in [A]Format/[B]Format]. The following file formats are available for selection.

- QuickTime (MPEG2):
QuickTime file format (.MOV)
- MXF (MPEG2):
MXF file format
- QuickTime (H.264):
QuickTime file format (.MOV)
- Exchange: (U model only)
Sports Video Interop Group format (.MP4)
- MP4 (H.264): (E model only)
MP4 file format

Memo : _____

- When [System] is set to “HD EXT(SSD)”, this item is fixed at “ProRes”.
- Exchange (U model) and MP4 (E model) are selectable only when [System] is configured to “HD”.
- When Exchange (U model) or MP4 (E model) is selected, backup recording and clip cutter function cannot be used.

Selecting a Video Format

- The selectable [Frame Rate]/[Bit Rate] changes according to the settings of [System]/[Format]/[Resolution].

List of Formats

The following is a list of file formats and video formats that can be selected on this camera recorder.

- When [System] is set to “HD EXT(SSD)”

Record Format				
[EXT] Format	[EXT] Resolution	[EXT] Frame Rate	[EXT] Bit Rate	[EXT] Audio
ProRes	1920x1080	30p, 25p, 24p	422	4CH 24 bit, 2CH 24 bit

Memo : _____

- [Rec Mode] is fixed at “Normal”.
- [Slot Mode] is fixed at “----”.
- The following functions cannot be used when HD EXT(SSD) is selected.
View Remote, Live Streaming, Return over IP, Overlay Function, Clip Cutter Trig

- When [System] is configured to “HD”, “HD +Web” or “HD(SDI In)”, the options for slot A are:

Record Format				
[A]Format	[A] Resolution	[A] Frame Rate	[A] Bit Rate	[A] Audio
QuickTime (MPEG2), MXF (MPEG2)	1920x1080	60i, 50i, 30p*, 25p*	35M (HQ)	4CH 16 bit/ 2CH 16 bit
	1440x1080	60i, 50i	35M (HQ), 25M (SP)	
	1280x720	60p, 50p	35M (HQ)	
QuickTime (H.264)	1920x1080	60p, 50p	4:2:2 100 70M (XHQ), 50M (XHQ)	4CH 24 bit/ 2CH 24 bit
			50M (XHQ)	
			4:2:2 100 50M (XHQ), 50M (UHQ)	
	1280x720	60p, 50p	4:2:2 100 50M (XHQ), 35M (UHQ)	4CH 24 bit/ 2CH 24 bit
			50M (XHQ)	4CH 16 bit/ 2CH 16 bit
			35M (UHQ)	4CH 16 bit/ 2CH 16 bit
Exchange (U model)	1920x1080	60p	12M (LP)	2CH
	1280x720		8M (LP)	
MP4 (H.264) (E model)	1920x1080	50p	12M (LP)	2CH
	1280x720		8M (LP)	

- * Not selectable when configuring “HD(SDI In)”.

Memo : _____

- When [System] is set to “HD” or “HD(SDI In)”, each item for slot B is fixed at the same setting as slot A.
- When [A]Format] is configured to “Exchange” or “MP4(H.264)”, selection is possible only when [System] is configured to “HD” or “HD(SDI In)”.
- The following functions cannot be used when HD+Web is selected.
View Remote, Live Streaming or Return over IP

■ When [System] is set to “High-Speed”

Record Format				
A Format	A Resolution	A Frame Rate	A Bit Rate	A Audio
QuickTime (H.264)	1920x1080	120/60p, 100/50p	4:2:2 (HQ), 70M (XHQ), 50M (XHQ)	2CH 24 bit
			4:2:2 (HQ), 50M (XHQ)	2CH 16 bit
		120/30p, 100/25p, 120/24p	4:2:2 (HQ), 50M (XHQ)	2CH 24 bit
			50M (XHQ), 35M (UHQ)	2CH 16 bit

Caution : _____

- When [System] → [Record Set] → [Record Format] → [System] is configured to “High-Speed”, network cannot be used via wireless LAN (CHU CHE) or the [HOST] terminal (USB). Configure as follows in this case.
 - Set [Network] → [Connection Setup] → [USB/Int. WLAN] to “Off”. (CHU CHE)
 - Unplug the USB network adapter
- Note that camera operation will come to an emergency stop and the power will turn off if the above steps are not performed. File data may be damaged if this happens while recording is in progress.

Memo : _____

- The [Rec Mode] is fixed at “Normal”.
- The following functions cannot be used when High-Speed is selected. View Remote, Live Streaming, Return over IP, Upload of recorded clip, time stamp recording and Pixel Mapping
- The settings for slot B are fixed at the same as slot A.
- When the [TC GEN] selection switch is set to “F-RUN”, the time code will be recorded in “R-RUN”.
- [TC/UB...] → [TC Mode] is fixed at “SW Set”.
- It is not possible to set a shutter speed that is slower than the frame rate. (Example: When 120/60p is selected, 1/120 to 1/9873 can be set.)
- The sensitivity of high speed shooting is lower than normal shooting. In order to capture more beautiful images, it is recommended to perform shooting in a lighted environment.
- The remaining space on the media (recordable time to the recording media) runs out faster than usual. (Example: For 120/60p, as the recording speed is twice as fast as usual, the remaining space on the media is reduced by approximately double the speed.)

■ When [System] is set to “SD” or “SD(SDI In)”:

Record Format				
A Format	A Resolution	A Frame Rate	A Bit Rate	A Audio
QuickTime (H.264)	720x480	60i (U model)	8M (HQ)	4CH 16 bit/ 2CH 16 bit
	720x576	50i (E model)		

Memo : _____

- The following function cannot be used when SD or SD (SDI input) is selected. Overlay Function
- Each item for slot B is fixed at the same setting as slot A.

■ When [System] is set to “HD+Web”, the options for slot B are:

Record Format				
B Format	B Resolution	B Frame Rate	B Bit Rate	B Audio
QuickTime (MPEG2), MXF (MPEG2)	1280x720	60p, 50p	6M (LP)	4CH/ 2CH
	960x540	30p, 25p	3M (HQ)	4CH/ 2CH
	480x270	30p, 25p	1.2M (LP)	4CH/ 2CH
QuickTime (H.264)	1280x720	60p, 50p	6M (LP)	4CH/ 2CH
	960x540	30p, 25p, 24p	3M (HQ)	4CH/ 2CH
	720x480	60i	8M (HQ)	4CH 16 bit/ 2CH 16 bit
	720x576	50i	8M (HQ)	
	480x270	30p, 25p, 24p	1.2M (LP)	4CH/ 2CH

Memo : _____

- The following functions cannot be used when HD+Web is selected. View Remote, Live Streaming or Return over IP

■ Selecting the Aspect Ratio of SD Videos

For setting the aspect ratio of the recorded image when [System] is set to “SD” or “SD(SDI In)”. You can select “16:9” or “4:3”.

Memo : _____

- For conditions other than those above, this item is fixed at “16:9”.

Zoom Operation

Adjusts the angle of view.

Zooming can be operated using the following.

- Zoom ring/zoom lever on the commercially available lens
- User buttons assigned with “Zoom Tele” and “Zoom Wide”

During the zoom operation, the zoom bar or number will appear on the upper right corner of the screen.

(☞ P173 [Zoom Display])

Caution :

- Depending on the zoom speed, the zoom drive noise of the power zoom may be recorded.

Using Zoom Ring/Zoom Lever on Commercially Available Lens

You can adjust the preferred angle of view by turning the zoom ring or operating the zoom lever.

Memo :

- For details on the lens, please refer to the “INSTRUCTIONS” of the lens used.

Using User Buttons Assigned with “Zoom Tele” and “Zoom Wide”

1 Assign “Zoom Tele” and “Zoom Wide” to the user buttons.

(☞ P45 [Assignment of Functions to User Buttons])

(☞ P113 [User Switch Set Item])

- Configure the zoom speed of the user buttons in [Camera Function] → [User Switch Set] → [Zoom Speed].
Increasing the value increases the zoom speed.

2 Press the user button assigned with “Zoom Tele”/“Zoom Wide” to zoom.

- The zoom operation is performed in the speed that has been set.

Memo :

- This function may not work depending on the lens attached.

Focus Operation

Adjusting the Focus

1 Turn the focus ring to adjust the focus.

Memo :

- Using the Focus Assist or Expanded Focus function makes it easier to focus.
(☞ P59 [Focus Assist Function])
(☞ P60 [Expanded Focus Function])

Focus Assist Function

- When the user button assigned with “Focus Assist” is pressed, the focused area is displayed in color. This enables easy and accurate focusing.
- Select the color (blue, red or green) in the menu.

Memo :

- When [LCD/VF] → [Shooting Assist] → [Focus Assist] → [Type] is set to “ACCU-Focus”, the depth of field becomes shallower to enable easier focusing.
(☞ P129 [Focus Assist])
- The “ACCU-Focus” function switches automatically to “Off” after about 10 seconds.
- Select the display color in [LCD/VF] → [Shooting Assist] → [Focus Assist] → [Color].
(☞ P129 [Color])
- If you use the zebra function and the Focus Assist function at the same time, it may be difficult to see the effect of the Focus Assist. In this case, turn off the zebra function.

Focus Assist + Function

- You can operate the Focus Assist and Expanded Focus functions simultaneously by pressing the user button assigned with “Focus Assist +”.

Memo :

- “Expanded Focus” is displayed during the “Focus Assist +” operation regardless of the setting in [Camera Function] → [User Switch Set] → [Expanded Focus].

Expanded Focus Function

You can magnify the preferred area by pressing the user button assigned with “Expanded Focus”; doing so enables precise focus to be established easily.

1 When the user button that is assigned with “Expanded Focus” is pressed.

- The center area of the screen is enlarged for the first time.
- For subsequent operation of the button, the area at which the operation was last performed will be enlarged.



2 Use the cross-shaped button (▲▼▶◀) to magnify the preferred area.

- The portion that is being magnified is displayed at the lower right corner of the screen.

3 Press the [CANCEL/RESET] button to cancel the setting.

Memo : _____

- The display of the enlarged screen is dot by dot equivalent.
- To set the operation when the button is pressed, go to [Camera Function] → [User Switch Set] → [Expanded Focus].
(P116 [Expanded Focus])
- Pressing and holding the Set button (●) resets the position of magnification.
- This function can be used together with the Focus Assist function.
- Magnifying an image does not alter the size of the recorded image.
- If the “Expanded Focus” function is assigned to the cross-shaped button, the cross-shaped button cannot be used as user button while the area is being magnified.
- This function is unavailable when [System] → [Record Set] → [Record Format] → [System] is set to “SD”.
- When the display screen is turned off, the magnified area at the bottom right of the screen will not be displayed.

Adjusting the Brightness

Adjust the brightness using Iris, Gain, Shutter speed and ND filter according to the brightness of the object.

Adjusting the Brightness Automatically: Automatic Brightness Adjustment (AE) Mode

Iris, Gain, Shutter speed and ND filter are automatically adjusted according to the brightness of the object to maintain optimum brightness.

To set only the Gain, Iris and Shutter to Auto mode, set the Full Auto mode to off before setting each item to the automatic adjustment mode using the user button assigned with “Full Auto”.

1 Set Gain, Iris and Shutter to Auto mode.

- [Adjusting the Iris] (P 61)
- [Setting the Gain] (P 62)
- [Setting the Electronic Shutter] (P 63)

2 Set the target level (brighter/darker) to maintain optimum brightness during automatic adjustment.

- Press the user button assigned with “AE Level” and when the “AE±” indication turns white operate the cross-shaped button (▲▼) to set the target level.
- This can be configured in [Camera Function] → [AE Level].

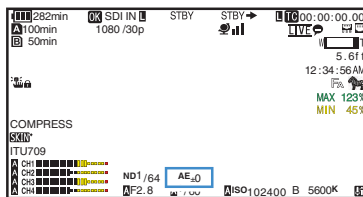

Memo : _____

- Using the user button assigned with “Full Auto” to enter the Full Auto mode also activates the automatic brightness adjustment (AE) mode. In this case, the White Balance also enters into Auto mode forcibly.
- The convergence speed of the automatic adjustment for automatic brightness adjustment (AE) can be set in the menu.
(☞ P111 [AE Speed])
- If one or more of the items (Gain, Iris and Shutter) have been set to Auto mode, the value of the corresponding items when the user button that is assigned “AE Lock” is pressed can be fixed.
(☞ P115 [AE Lock])
- If one or more of the items (Gain, Iris and Shutter) have been set to Auto mode, the automatic brightness adjustment (AE) mode is enabled.

Adjusting the Brightness Manually

Use the user button assigned with “Full Auto” to set Full Auto mode to off, some or all of the items (Iris, Gain and Shutter Speed) can be manually adjusted.

- 1 **Set Full Auto mode to off using the user button assigned with “Full Auto”.**
- 2 **Adjust the Iris, Gain and Shutter speed.**
 - [Adjusting the Iris] (☞ P 61)
 - [Setting the Gain] (☞ P 62)
 - [Setting the Electronic Shutter] (☞ P 63)

Memo : _____

- The brightness cannot be manually adjusted in the Full Auto mode.
- If Iris, Gain and Shutter Speed are manually adjusted, the [AE Level] setting is temporarily disabled.

Adjusting the Iris

Adjust the aperture of the lens iris according to the brightness of the subject.

Manual Iris (Manual Adjustment) Mode

The aperture value (F-number) of the lens can be set manually.

- 1 **Set Full Auto mode to off using the user button assigned with “Full Auto”.**
- 2 **Set to Manual Iris mode using the [IRIS A/M] switch on the lens.**
The lens aperture value (F-number) is displayed.

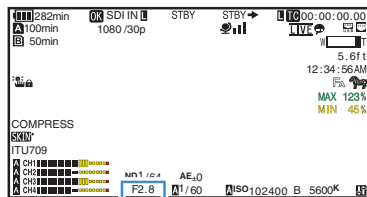

- 3 **Turn the iris ring on the lens to adjust the iris manually.**

The open F-number of the aperture varies according to the zoom position.

F-number	Description
Decrease	The subject appears brighter. The focused range becomes sharper, while the background is blurred to produce a soft image.
Increase	The subject appears darker. Background of image becomes focused as well.

Memo : _____

- Even while in the Manual Iris mode, pressing and holding the [IRIS] button on the lens switches the camera recorder to the Push Auto Iris mode.

Push Auto Iris

When the camera recorder is in the Manual Iris mode, press and hold the [IRIS] button on the lens to change to the Auto Iris mode temporarily. The iris will be automatically adjusted according to the brightness of the subject.

Auto Iris (Automatic Adjustment) Mode

- 1 **Set Full Auto mode to off using the user button assigned with “Full Auto”.**
- 2 **Set to Auto Iris mode using the [IRIS A/M] switch on the lens.**
The iris is automatically adjusted according to the brightness of the object.
A **A** icon appears on the left side of the lens aperture value (F-number) in the Auto Iris mode.

Memo : _____

- Use the user button assigned with “Full Auto” to enter the Full Auto mode also activates the Auto Iris mode. In this case, the Gain, Shutter and White Balance also enter into Auto mode forcibly.
The iris operation during Full Auto mode can be configured in [Camera Function] → [Full Auto] → [Iris Control].
- The iris open/close limit can be set in [Camera Function] → [Auto Iris Limit (OPEN)]/[Auto Iris Limit (CLOSE)] during Auto Iris.
(☞ P112 [Auto Iris Limit (OPEN)])
(☞ P112 [Auto Iris Limit (CLOSE)])
- You can press the user button assigned with “AE Level” and use the cross-shaped button (▲▼) to configured the target level (brighter/darker) of the auto iris in [Camera Function] → [AE Level].
- The convergence speed of the auto iris can be set in the menu.
(☞ P111 [AE Speed])
- While in the Auto Iris mode, and [AE Lock] is set to “AE” or “AE/FAW”, a **L** icon appears on the left side of the lens aperture value (F-number) during lock operation.

Setting the Gain

This function electrically boosts the light sensitivity when there is insufficient illumination on the object. You can set the gain of the video amplifier according to the brightness of the object. Select the setting mode according to your shooting conditions.

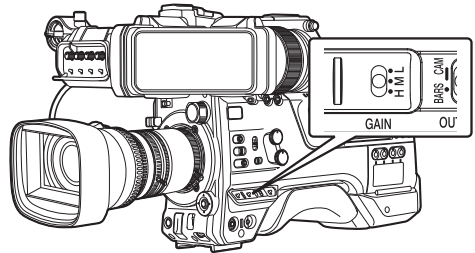

Manual Gain Mode (Manual Gain Switching)

- 1 **Set Full Auto mode to off using the user button assigned with “Full Auto”.**
 - Select the gain level of the video amplifier using the [GAIN L/M/H] selection switch on the camera recorder.
 - The gain level appears on the screen.

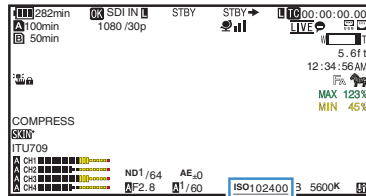

- The default positions of the switch are as follows.

[L] : 0 dB
[M] : 6dB
[H] : 12dB

- 2 **Select [GAIN L/M/H] that is not set to “AGC” to switch to the Manual Gain mode.**

Memo : _____

- You can change the gain value of each position in the menu. Increasing the sensitivity causes the screen to appear grainier.
- The camera recorder switches to the Auto Gain mode when the gain value is set to “AGC”.
(☞ P112 [GAIN L, GAIN M, GAIN H])

Automatic Gain Mode (Automatic Gain Adjustment)

- 1 Set Full Auto mode to off using the user button assigned with “Full Auto”.
- 2 Set [Camera Function] → [GAIN L]/[GAIN M]/[GAIN H] to “AGC”.
(☞ P112 [GAIN L, GAIN M, GAIN H])
If an item specified with “AGC” is selected using the [GAIN L/M/H] gain switch, the Auto Gain Adjustment mode is enabled and the gain of the video amplifier is automatically set according to the brightness of the subject.

Memo : _____

- Use the user button assigned with “Full Auto” to enter the Full Auto mode also activates the Auto Gain mode. In this case, the Iris, Shutter and White Balance also enter into Auto mode forcibly.
- The gain operation during Full Auto mode can be configured in [Camera Function] → [Full Auto] → [Gain].
- The upper limit of the gain setting value during AGC operation can be set in [Camera Function] → [AGC Limit].
(☞ P112 [AGC Limit])
- While in the Auto Gain mode, and [AE Lock] is set to “AE” or “AE/FAW”, a  icon appears on the left side of the gain value during lock operation.

Setting the Electronic Shutter

You can change the shutter speed (time for each shooting frame) using the electronic shutter function. Electronic shutter can be adjusted manually or automatically.

Manual Shutter Mode (Manual Shutter Switching)

- 1 Set Full Auto mode to off using the user button assigned with “Full Auto”.
- 2 Set [Camera Function] → [Shutter] to “Slow” or “Step/Variable”.
 - The shutter speed appears on the screen.

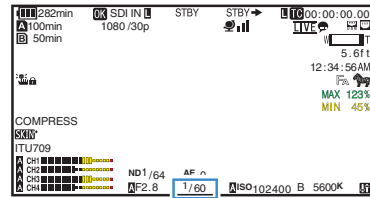

Memo : _____

- To display Shutter in angle (DEG), set [A]Frame Rate] to “25p” and set [LCD/VF] → [Display Type] → [Shutter] to “DEG”.
(☞ P161 [A]Frame Rate/ [EXT] Frame Rate])
(☞ P111 [Shutter])

Switching Shutter Speed

■ Manual shutter mode (step/variable)
Press down the [SHUTTER] switch toward the “SEL” end. When the shutter speed indication turns white, press down the [SHUTTER] switch repeatedly to change the setting.
Example:

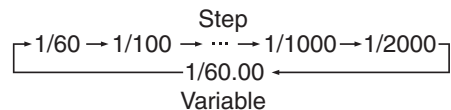

After the shutter speed indication turns white, the setting value can be changed using the cross-shaped button (▲▼).

You can use the cross-shaped button ► to switch to variable mode and the cross-shaped button ◀ to switch to step mode.

Shutter Mode	Frame Rate	Setting Value	Setting Value (Shutter OFF)
Step	60p, 60i, 30p	1/60, 1/100, 1/120, 1/250, 1/500, 1/1000, 1/2000	1/60
Variable			
Step	50p, 50i, 25p	1/50, 1/60, 1/100, 1/120, 1/250, 1/500, 1/1000, 1/2000	1/50
Variable			

■ Manual shutter mode (low speed)

Press down the [SHUTTER] switch toward the “SEL” end. When the shutter speed indication turns white, press down the [SHUTTER] switch repeatedly to change the setting.

After the shutter speed indication turns white, the setting value can also be changed using the cross-shaped button (▲▼).

Shutter Mode	Frame Rate	Setting Value	Setting Value (Shutter OFF)
Slow	60p, 60i, 30p	1/30, 1/15, 1/7.5, 1/3.75	1/60
	50p, 50i, 25p	1/25, 1/12.5, 1/6.25, 1/3.125	1/50

Automatic Shutter Mode (Automatic Shutter Adjustment)

- 1 Set Full Auto mode to off using the user button assigned with “Full Auto”.
- 2 Set [Camera Function] ➔ [Shutter] to “EEI”.
 - Automatic Shutter mode adjusts the shutter speed automatically according to the brightness of the object.
- 3 Set the controllable range for the Automatic Shutter in [Camera Function] ➔ [EEI Limit]. (P112 [EEI Limit])

Memo : _____

- Use the user button assigned with “Full Auto” to enter the Full Auto mode also activates the Automatic Shutter mode. In this case, the Iris, Gain and White Balance also enter into Auto mode forcibly.
- The shutter operation during Full Auto mode can be configured in [Camera Function] ➔ [Full Auto] ➔ [Shutter].
- While in the Automatic Shutter mode, and [AE Lock] is set to “AE” or “AE/FAW”, a [L] icon appears on the left side of the shutter speed during lock operation.

Adjusting the White Balance

Adjust the white balance according to the color temperature of the lighting. You can select the adjustment mode according to the shooting conditions.

As the color of the light (color temperature) varies according to the light source, it is necessary to readjust the white balance when the main light source illuminating the subject changes.

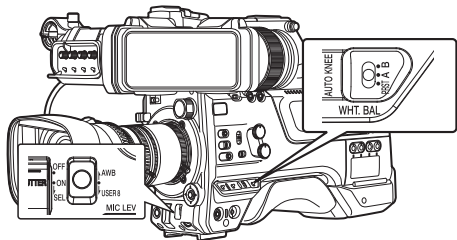

Automatic White Balance Mode (FAW: Fulltime Auto White balance)

- 1 Set Full Auto mode to off using the user button assigned with “Full Auto”.
- 2 Assign “FAW” (Full Auto White Balance) to one of the three [WHT.BAL] switches.
 - You can set the Full Auto White Balance feature to either “A”, “B”, or “PRST” in [Camera Function] → [FAW].
(☞ P112 [FAW])
 - If the position assigned with “FAW” is selected using the [WHT BAL B/A/PRST] switch, the Automatic White Balance mode is enabled and an appropriate white balance is automatically adjusted according to the color temperature of the lighting on the subject.

Caution :

- The accuracy of [FAW] is inferior to that of [AWB] (Auto White Balance).
- When the power of the camera recorder is turned on with the [FAW] mode selected, it takes about 15 seconds for the colors to stabilize.

Memo : _____

- Use the user button assigned with “Full Auto” to enter the Full Auto mode also activates the Automatic White Balance mode. In this case, the Iris, Gain and Shutter also enter into Auto mode forcibly.
- The white balance operation during Full Auto mode can be configured in [Camera Function] → [Full Auto] → [White Balance].
- When [Camera Function] → [User Switch Set] → [AE Lock] is set to “AE/FAW” or “FAW”, the white balance when the user button that is assigned with [AE Lock] is pressed can be fixed while in the Automatic White Balance mode.
(☞ P115 [AE Lock])
- If [White Balance] is assigned to the user button, pressing the assigned user button will display the FAW Paint Adjustment screen.
(☞ P45 [Assignment of Functions to User Buttons])

FAW Paint Adjustment

You can fine-adjust the white balance that was automatically adjusted.

- 1 Select [Camera Process] → [White Balance] → [FAW Paint] and press the Set button (●).
The FAW Paint Adjustment screen appears.

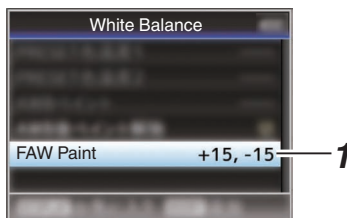

- 2 Adjust the R and B values.
Use the cross-shaped button (▲▼) to adjust R value and (◀▶) to adjust B value.

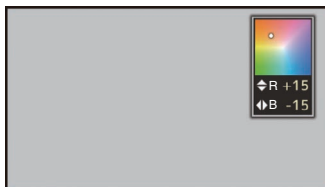

- 3 Press the Set button (●).
Returns to the [White Balance] screen.

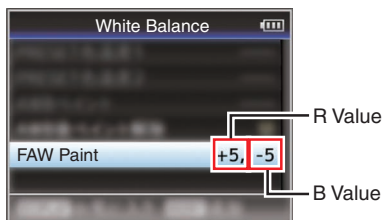

Manual White Balance Mode (Manual Switching)

- 1 Set Full Auto mode to off using the user button assigned with “Full Auto”.
- Use the [WHT.BAL] switch to select “PRST” (preset mode), “A” (memory A mode), or “B” (memory B mode).

Memo : _____

- You can set the Full Auto White Balance feature to either [A], [B], or [PRST] in [Camera Function] → [FAW].
(P112 [FAW])
- The FAW (Full Time Auto White Balance) mode makes automatic adjustments by sampling the color temperature of the video to obtain the most appropriate white balance level.

Preset Mode (PRST)

- Two different color temperature settings are registered on this camera recorder. You can switch between them by pushing the [AWB/USER8] switch upward or using the user button assigned with “AWB”.

Default setting:

[Preset Temp.] : 3200K

[Alternative Temp.] : 5600K

- 1 Set the [WHT.BAL] switch to “PRST”.
- 2 Push the [AWB/USER8] switch upward or press the user button assigned with the “AWB” function.
- The color temperature switches.
 (“Preset Temp.” ↔ “Alternative Temp.”)

Setting the [Preset Temp.] or [Alternative Temp.] Values

You can change both the color temperature settings in the Preset mode in the menu.

- 1 Open the [Preset Temp.] or [Alternative Temp.] menu.

- Select [Camera Process] → [White Balance] → [Preset Temp.] and [Alternative Temp.], and press the Set button (●).
- The Color Temperature setting screen appears.

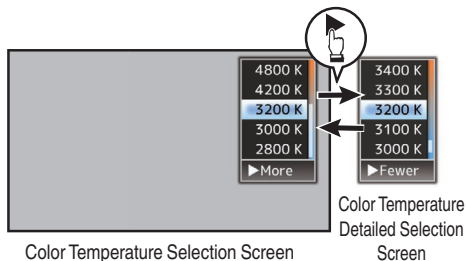

- 2 Select the color temperature.

- When selecting from a setting value (Color Temperature Selection screen), use the cross-shaped button (▲▼) to select the color temperature.
[Setting Values: 7500K, 6500K, 5600K, 5200K, 4800K, 4200K, 3200K, 3000K, 2800K]
- To select detailed values (Color Temperature Detailed Selection screen)
 - Press the cross-shaped button (▶) to display the Color Temperature Detailed Selection screen.
 - Use the cross-shaped button (▲▼) to select a color temperature.
[Setting Values: 2300K to 15000K (in 100K increments)]

Memo : _____

- Use the cross-shaped button (▶) to switch between the Color Temperature Selection screen and the Color Temperature Detailed Selection screen.
- If [White Balance] is assigned to the user button, pressing the assigned user button will display the Color Temperature Selection screen.
(P45 [Assignment of Functions to User Buttons])

Preset Paint Adjustment

The white balance for [Preset Temp.] and [Alternative Temp.] can be fine adjusted individually or collectively.

- 1 Select [Camera Process] → [White Balance] → [Preset Paint Memory].
 - “Common” configures the settings for the entire color temperature range collectively.
 - “Individual” configures the settings for the 9 types of color temperature individually.
- 2 Select [Camera Process] → [White Balance] → [Preset Paint].
 - The adjustment screen appears if “Common” is selected.
 - The lower color temperature limit of the color temperature range is displayed if “Individual” is selected. Select the color temperature to adjust.
In the case of 2300K for example, the target range is 2300K to 2900K (less than 3000K)
- 3 Adjust the R and B values.
 - Use the cross-shaped button (▲▼) to adjust R value and (◀▶) to adjust B value.
- 4 Press the Set button (●).
 - In the case of “Common”, the display returns to the [White Balance] screen.
 - As for “Individual”, repeat steps 1 to 4 as necessary to configure each color temperature individually.

Memory A Mode (A), Memory B Mode (B)

- Set to the white balance saved in Memory A or Memory B.
 - When the [WHT.BAL] switch is set to “A” or “B”, pushing the [AWB/USER8] switch upward or pressing the user button assigned with the “AWB” function executes Auto White Balance. The white balance will be automatically adjusted and the adjusted value will be saved in Memory A or Memory B.
- 1 Prepare the camera recorder.
 - ① Set the [POWER ON/OFF] switch to “ON”.
 - ② Set Full Auto mode to off using the user button assigned with “Full Auto”.
 - ③ Set the [IRIS A/M] mode switch on the lens to “A”.
 - 2 Set the [ND FILTER] switch according to the lighting.
 - 3 Set the [WHT.BAL] switch to “A” or “B”.

- 4 Locate a place with similar lighting conditions as the object to be shot, place a white object near the center of the screen and zoom in to fill the screen with white.
- 5 Push the [AWB/USER8] switch upward or press the user button assigned with the “AWB” function.
 - The white detection frame appears when Auto White Balance is activated. Fill the frame with white completely.
 - While Auto White Balance is starting up, “A ●” or “B ●” appears on the screen. (● mark appears blinking)
 - After the correct white balance is obtained, an estimated value of the current color temperature is displayed.

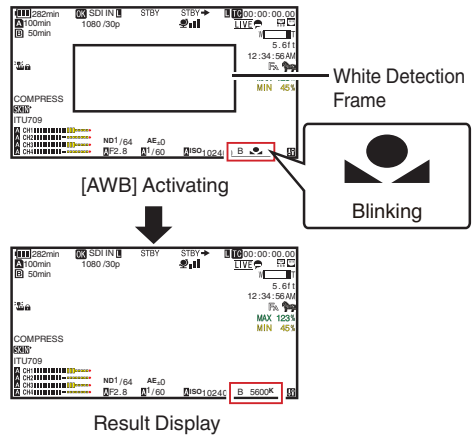

Caution :

- Do not use highly reflective objects, such as metals. Doing so may result in improper white balance adjustment.
- The Auto White Balance function cannot provide optimum white balance with an object outside the adjustment range, for example when it contains only a single color or not enough white color.

Error Message

If the Auto White Balance adjustment is not correctly completed, one of the following messages will appear for about 3 seconds.

Message	Status
Auto White * NG: Object (*A or B)	Displayed when there is not enough white color on the object, or when the color temperature is not suitable. Use another white object and adjust the white balance again.
Auto White * Error: Low Light (*A or B)	Displayed when the lighting is dark. Increase the lighting and adjust the white balance again.
Auto White * Error: Over Light (*A or B)	Excessive illumination. Displayed when the lighting is too bright. Decrease the lighting and adjust the white balance again.

White Paint Adjustment

You can fine-tune the white balance saved in Memory A or Memory B.

- 1 **Select [Camera Process] → [White Balance] → [AWB Paint] and press the Set button (●).**

The White Paint Adjustment screen appears.

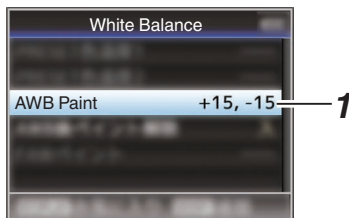

- 2 **Adjust the R and B values.**

Use the cross-shaped button (▲▼) to adjust R value and (◀▶) to adjust B value.

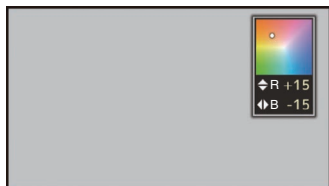

- 3 **Press the Set button (●).**

Returns to the [White Balance] screen.

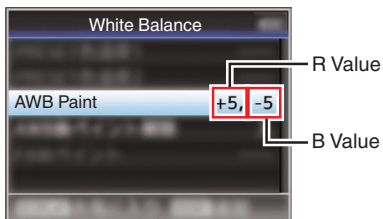

Memo : _____

- Executing Auto White Balance will usually clear the White Paint Adjustment value. But when [Camera Process] → [White Balance] → [Clear Paint After AWB] is set to "Off", values will not be cleared even when Auto White Balance is executed.
(☞ P125 [Clear Paint After AWB])
- If [White Balance] is assigned to the user button, pressing the assigned user button will display the AWB Paint Adjustment screen.
(☞ P45 [Assignment of Functions to User Buttons])

Vertical Shading Adjustment

- Adjustment of white shading is needed when you have changed the lens.
- Although white balance may be appropriate at the center of the image, this may not be the case at the top and bottom areas.
If this is the case, the image will appear greenish or yellowish. This phenomenon is due to the characteristics of the lens. The process of correcting this phenomenon is referred to as vertical shading adjustment.
- Perform this process after adjusting the white balance.

Setup Prior Adjustment

- 1 Obtain the white balance on the camera.**
(P67 [Memory A Mode (A), Memory B Mode (B)])
- 2 Set the control of the camera lens as follows.**
 - ① Set the iris to F4.0 or narrower to obtain the appropriate brightness.
If the brightness is insufficient at F4.0, obtain the appropriate brightness such as by adjusting the lighting.
 - ② When using a zoom lens, set to the center of the zoom adjustment range.
- 3 Fill the monitor screen with a pattern box of a uniform light source, or a piece of white (plain) paper that is uniformly illuminated.**
- 4 Set the chroma level of the monitor to the maximum.**
- 5 Check the monitor screen.**
 - There is no need for adjustment if there is no color at the top and bottom of the screen.
 - If the top of the screen is greenish and the bottom is reddish or vice versa, continue this adjustment.

Adjusting the Vertical Shading

- 1 Set [Camera Process] → [White Balance] → [V. Shading] to “On”.**
- 2 Select [Adjust...] in [V. Shading] and press the Set button (●).**
The Vertical Shading Adjustment screen appears.

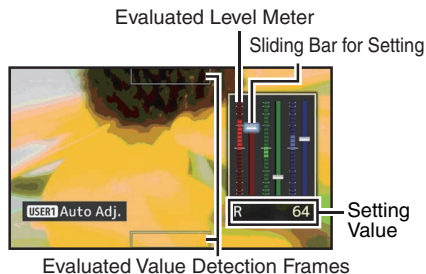

- 3 Press the [USER1] button to set to perform automatic adjustment.**
You can use the R, G, B channels individually to adjust the value of the evaluated level meter up to a margin error of ± 1 from the median value.
- 4 Adjust manually.**
 - If you want to adjust manually after automatic adjustment is performed, follow the steps below.
 - You are recommended to adjust the G (green) level only.
 - If manual adjustment is not necessary, adjustment is complete at step 7.
- 5 Use the cross-shaped buttons (◀▶) to select the item to adjust from [R] / [G] / [B] .**
- 6 Adjust the setting value using the cross-shaped buttons (▲▼).**
 - Adjust the sliding bar for setting while referring to the evaluated level meter.
 - Adjust the values such that the evaluated value falls almost at the center of the meter using the ▼ cross-shaped button if the evaluated value of the channel to be adjusted is larger than the median value, and the ▲ cross-shaped button if the evaluated value is smaller than the median value.
- 7 Press the Set button (●) to save the setting.**
 - Make sure to press the Set button (●) to save the setting.
 - Pressing the [CANCEL/RESET] button discards the setting and returns to the menu screen at the next higher level.

Memo : _____

- There may be some delay in the changes of the evaluated value after pressing the cross-shaped button (▲▼).
- Increasing the setting value suppresses the colors at the bottom and enhances the colors on top.
- Adjustment is not possible in the following cases. An error message will appear.
 - When the top and bottom ends of the frame are overexposed
 - When the top and bottom ends of the frame are underexposed
 - When there is significant difference in the level between the top and bottom ends of the frame

What is evaluated value?

This is a relative value (difference between the top and bottom ends) with respect to the average value of the R, G, B channels within the evaluated value detection frames at the top and bottom of the LCD monitor or viewfinder.

The evaluated value is positioned higher than the center of the evaluated level meter when the level at the top is higher than that at the bottom end. Similarly, the evaluated value is positioned lower than the center of the evaluated level meter when the level at the top is lower than that at the bottom end.

Adjust the evaluated value such that it falls almost at the center of the meter.

Adjusting the Camera Image

The picture quality of the camera can be set using the [Camera Process] menu.

As the adjustments are shown on the screen, you can adjust the values while checking the picture quality on the camera.

- [Color Space]
- [Gamma]
- [Detail]
- [Master Black]
- [Black Paint]
- [Flare]
- [V. Shading]
- [Black Toe]
- [Knee Level]
- [Auto Knee Sensitivity]
- [Auto Knee Peak Filter]
- [White Clip]
- [Chroma Clip]
- [White Balance]
- [Color Matrix]
- [Color Gain]
- [Reverse Picture]
- [DNR]

Memo : _____

- For details of the respective items, see the [Camera Process] menu.
(☞ P118 [Camera Process Menu])

Audio Recording

You can record audio from the four channels (CH1/CH2/CH3/CH4) in synchronization with the video images on this camera recorder.

Select from the options below to record the audio.

- Microphone connected to [MIC IN] terminal (XLR 5-pin)
- Microphone or line input connected to the [AUDIO INPUT1] terminal (XLR 3pin)
- Microphone or line input connected to the [AUDIO INPUT2] terminal (XLR 3pin)

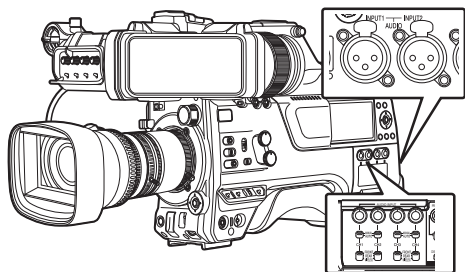

Setting the Number of Recording Channels

- Set the number of recording channels in [System] → [Record Set] → [Record Format] → [Audio].

Selecting Audio to Be Recorded in Each Channel

Select the audio to be recorded in CH1/CH2/CH3/CH4.

-	Switch Setting	Connected Devices
CH1 CH3	FRONT	• Audio input of microphone 1 from [MIC IN] terminal
	REAR	• Audio input from [AUDIO INPUT1] terminal
	WIRELESS	• Audio input of CH1 from the “UniSlot” wireless receiver
CH2 CH4	FRONT	• Audio input of microphone 2 from [MIC IN] terminal
	REAR	• Audio input from [AUDIO INPUT2] terminal
	WIRELESS	• Audio input of CH2 (or CH1) from the “UniSlot” wireless receiver

When the switch setting is set to “FRONT”

Audio recording is performed according to the setting in [A/V Set] → [Audio Set] → [Front Mic Select]/[Front Mic Power]/[Front Mic 1 Ref.]/[Front Mic 2 Ref.].

Caution :

- Set [Front Mic Select] to “Stereo M/S” to convert the audio signal to stereo (L/R) signal for recording when a Mid/Side direct output microphone is connected.
Do not set to “Stereo L/R” or “Mono” when an L/R out stereo microphone or a monophonic microphone is connected.

When the switch setting is set to “REAR”

Select the audio input to the [AUDIO INPUT 1/2] terminal using the [AUDIO INPUT 1/2] switch.

Setting	Description
[LINE]	Use this setting when connecting to an audio device or other equipment.
[MIC]	Use this setting when connecting to a dynamic microphone.
[MIC+48V]	Use this setting when connecting to a microphone (phantom microphone) that requires a +48 V power supply.

Memo :

- When “LINE” is selected, configure the reference input level in [A/V Set] → [Audio Set] → [Rear Line Ref.].
(☞ P139 [Rear Line Ref.])
- When “MIC” or “MIC+48V” is selected, set the reference input level in [A/V Set] → [Audio Set] → [Rear Mic 1 Ref.]/[Rear Mic 2 Ref.].
(☞ P139 [Front Mic 1 Ref.])
(☞ P139 [Front Mic 2 Ref.])

Caution :

- When connecting a device that does not require a +48 V power supply, make sure that it is not set to the “MIC+48V” position.
- When the [AUDIO INPUT 1/2] switch is set to “MIC”, make sure that a microphone is connected to the [AUDIO INPUT 1/2] terminal. If you increase the recording level when a microphone is not connected, noise from the input terminal may be recorded.
- When a microphone is not connected to the [AUDIO INPUT 1/2] terminal, set the [AUDIO INPUT 1/2] switch to “LINE”.

When the switch setting is set to “WIRELESS”

Recording is performed as follows according to the setting in [A/V Set] → [Audio Set] → [Wireless Channel].

	“UniSlot” Wireless Receiver		Camera
Single:	CH1	➔	CH1/CH2
Dual:	CH1	➔	CH1
	CH2	➔	CH2

Caution :

- Power is supplied to the “UniSlot” wireless receiver when any of the CH1/CH2/CH3/CH4 switches is set to “WIRELESS”.

Adjusting the Audio Recording Level

You can select to adjust the audio recording levels for each of the four channels (CH1/CH2/CH3/CH4) manually or automatically.

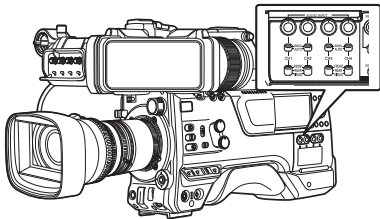

Manual Adjustment Mode (Manual Adjustment)

- The manual adjustment mode is enabled by setting the [AUDIO SELECT CH1/2/3/4]-[MANUAL/AUTO] selection switch on this camera recorder to “MANUAL”. The audio level for each channel can be configured in [A/V Set] ➔ [Audio Set] ➔ [CH1 Audio Level]/(2/3/4) ➔ [Front]/[Rear/Wireless].
- You can adjust the level manually during the recording, recording standby, and stop modes.

Memo :

- The audio setting in Full Auto mode can be configured in [Camera Function] ➔ [Full Auto] ➔ [Audio Set].

1 Set the [AUDIO SELECT CH1/2/3/4]-[MANUAL/AUTO] selection switch to “MANUAL” for the channel to be adjusted manually.

2 Turn the adjustment knob corresponding to the channel to adjust the level.

When [A/V Set] ➔ [Audio Set] ➔ [CH1/2 DRC]/[CH3/4 DRC] ➔ [Threshold Level] is set to “Off”, adjust such that the audio level meter -2 dB does not light up even for loud sounds.
(P140 [Threshold Level])

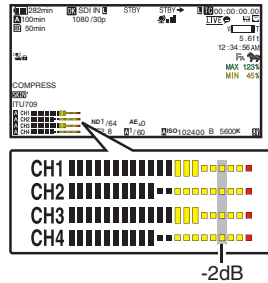

Memo : _____

- The [Threshold Level], [Attack Time], [Decay Time], [Mode], etc. of the compressor can be configured in [A/V Set] → [Audio Set] → [CH1/2 DRC]/[CH3/4 DRC] for the audio to be recorded.
 - * DRC (Dynamic Range Compressor)
- The limiter operates according to the setting in [A/V Set] → [Audio Set] → [Limiter] → [CH1]/[2/3/4].
When [Limiter] is set to “Off”, the limiter function is disabled even when the [MANUAL/AUTO] switch is set to “AUTO”. This may cause the OVER indication of the level meter to light up.
- The reference audio level is configured in [A/V Set] → [Audio Set] → [CH1/2 Audio Ref. Lv.] (common for CH1/2)/[CH3/4 Audio Ref. Lv.] (common for CH3/4).

Automatic Adjustment Mode

- Set the [AUDIO SELECT CH1/2/3/4]-[MANUAL/AUTO] selection switch to “AUTO” or press the user button assigned with “Full Auto” to set Full Auto mode to off. This activates the Automatic Adjustment mode and the audio recording level is configured automatically according to the input level.
- The audio setting in Full Auto mode can be configured in [Camera Function] → [Full Auto] → [Audio Set].

Memo : _____

- If [A/V Set] → [Audio Set] → [CH1/2 DRC]/[CH3/4 DRC] → [Threshold Level] is set to a value other than “Off”, the compressor operates according to the value set.

References on DRC (Dynamic Range Compressor) and Limiter

DRC and Limiter Configuration Block Diagram

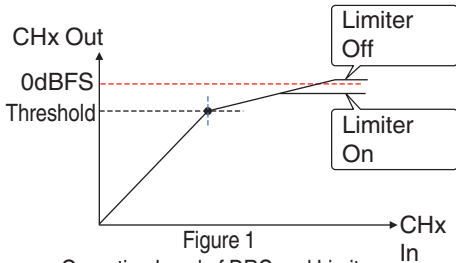
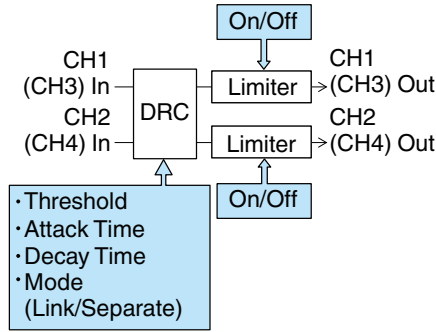

Figure 1
Operating Level of DRC and Limiter

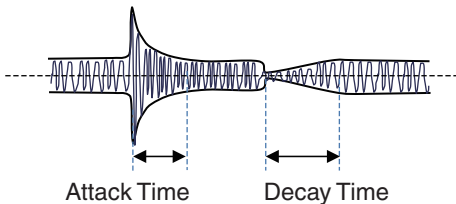

Figure 2 DRC Response Characteristics

• DRC Operation

This operation helps to prevent the recording level from reaching saturation (0 dBFS) by slowing down the gain changes when the excessive sound input exceeds the threshold level.

- [CH1/2 DRC] and [CH3/4 DRC] settings
 - Threshold : This is the point when the gain changes slowly. (See Figure 1) Lowering the threshold level will make it difficult for the recording level to become saturated but this will decrease the sound volume.
 - Attack Time : This is the response time from when the sound exceeds the threshold level until the level is compressed. (See Figure 2) “Fast” will result in fast response time and “Slow” will result in slow response time.
 - Decay Time : This is the response time from when the excessive sound input falls below the threshold level until the level compression operation is canceled. (See Figure 2) “Fast” will result in fast response time and “Slow” will result in slow response time.
 - Mode : CH1 (CH3)/CH2 (CH4) operate independently (mono) when “Separate” is selected. CH1 (CH3)/CH2 (CH4) operate in tandem (stereo) when “Linked” is selected. The level difference between CH1 (CH3)/CH2 (CH4) remains constant.
- “Fast” and “Middle” in the Attack setting are suitable for speech. “Middle” and “Slow” are suitable for music.
- “Fast” and “Middle” in the Decay setting are suitable for speech. “Middle” and “Slow” are suitable for music.
- When using a stereo microphone with CH1 (CH3)/CH2 (CH4), configure the Mode setting to “Linked”. To record different audio with CH1 (CH3)/CH2 (CH4), configure the Mode setting to “Separate”.

• Limiter Operation

A high speed response limiter that does not exceed the saturation level (0 dBFS) for sharp increase in the sound input not trackable by DRC.

• [Limiter] settings

- On : Enables the limiter separately for CH1/CH2/CH3/CH4.
- Off : Disables the limiter separately for CH1/CH2/CH3/CH4.
- AUTO/MANUAL SW Set : The limiter is enabled when the [MANUAL/AUTO] selection switch is set to “AUTO” and disabled when “MANUAL” is selected.

Audio Output during Recording

- You can check the recorded audio from the monitor speaker or the headphone connected to the [PHONE] terminal.
- Adjust the volume of the speaker or headphone using the [MONITOR] volume adjustment knob.

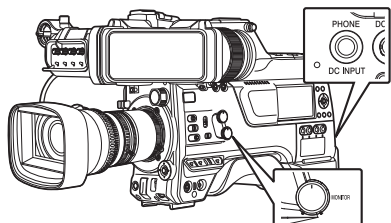

Memo : _____

- Warning tone is output when there is an abnormality in the camera recorder or when the battery is low.
(☞ P242 [Warning Tone])
- The volume of the warning tone can be adjusted using the [ALARM] volume adjustment knob or configured in [A/V Set] → [Audio Set] → [Min. ALARM Level].
(☞ P141 [Min. ALARM Level])

Time Code and User's Bit

Time code and user's bit data are recorded with the video in this camera recorder. The time code and user's bit are displayed on the viewfinder and LCD monitor during playback or recording. (Display screen)

Displaying Time Code and User's Bit

The time code and user's bit are displayed on the viewfinder and LCD monitor during playback or recording.

The display differs according to the menu settings.

1 Set [LCD/VF] → [Display On/Off] → [TC/UB] to "On".

(☞ P133 [Display On/Off Item])

When "TC" or "UB" is selected, time code or user's bit data is displayed respectively on the display screen.

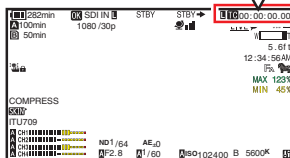
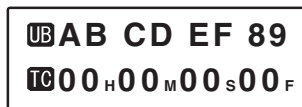

2 Select the display using the [TC DISPLAY] TC/UB display switch.

Select time code display ([TC]) or user's bit display ([UB]).

| Time Code Operation Mode

Select the time code operation using the [TC GEN] switch.

Setting	Description
F-RUN	The time code operates in the run mode at all times regardless of the recording status. It continues to run even when the power of the camera recorder is turned off. Synchronizes with the external time code when an external time code generator is connected. (P80 [Synchronizing the Time Code with an External Time Code Generator])
R-RUN	The time code operates in the run mode during recording. It continues to run in the order of the recorded clips as long as the SD card is not replaced. If the SD card is removed and recording is made on another card, time code will be recorded on the new card from where it was left off in the previous card.
REGEN	The time code operates in the run mode during recording. When the SD card is replaced, the last time code recorded on the card is read and recorded on a new card so that the time code continues in running order. (P77 [Setting Time Code])

Memo : _____

- When [System] → [Record Set] → [Rec Mode] is set to “Interval Rec” or “Frame Rec”, and the [TC GEN] switch is set to “F-RUN”, R-RUN mode is activated.
- When [System] → [Record Set] → [Record Format] → [System] is set to “High-Speed”, and the [TC GEN] switch is set to “F-RUN”, R-RUN mode is activated.

Setting Time Code Generator

| Presetting the Time Code

Time code and user's bit data generated from the internal time code generator are recorded.

This section describes how to set [TC/UB] → [TC Preset].

(P126 [TC Preset])

Memo : _____

- When [System] → [Record Set] → [Record Format] → [A Frame Rate] is set to “50p”, “50i” or “25p”, setting for “Drop” will be disabled. (P161 [A Frame Rate/ EXT Frame Rate])
- You can configure the setting without accessing the [TC/UB] menu screen. (P78 [Setting Time Code without Opening the Menu])

Required Settings Before Preset

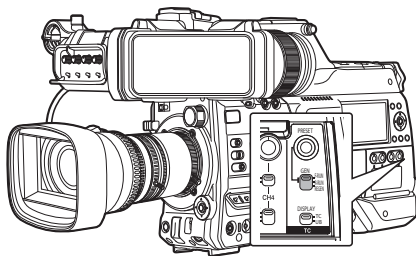

1 Set the [TC GEN] switch to “R-RUN” or “F-RUN”.

- [R-RUN]
 - Preset data in the time code generator operates in run mode during recording mode. Set this when recording continuous time code in connecting frames.
- [F-RUN]
 - Time code starts to operate in run mode from the preset time in the time code generator.

2 Select the framing mode for the time code generator (only when the frame rate setting is “60” or “30”).

To configure the setting, go to [TC/UB] → [Drop Frame].

(P127 [Drop Frame])

- [Drop]:
Sets the run mode of the time code generator to drop frame mode. Use this setting when placing emphasis on the recording time.
- [Non Drop]:
Sets the run mode of the time code generator to non-drop frame mode. Use this setting when placing emphasis on the number of frames.

Memo : _____

Drop frame/non-drop frame mode

- When [System] → [Record Set] → [Record Format] → [Frame Rate] is set to “60p”, “60i”, or “30p”, the actual number of frames per second is approximately 59.94 (29.97). However, the time code processing standard is “60p”, “60i”, or “30p” frames. To make up for the frame number discrepancy, the drop frame mode (Drop) drops the 00 frame and 01 frame every minute except for minutes that are multiples of 10. However, in the case of “60p”, the 00, 01, 02 and 03 frame are dropped.
- The non-drop frame mode (Non Drop) does not drop frames and ignores the discrepancy with the actual time.

Setting Time Code

1 Select [TC/UB] → [TC Preset] and press the Set button (●).

(P126 [TC Preset])

The [TC Preset] screen appears.

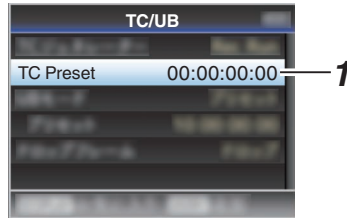

Memo : _____

- When the [TC GEN] switch is set to “REGEN”, the parameter is displayed as “REGEN” and selection is disabled.

2 Set the time code (hour, minute, second, frame).

Use the cross-shaped button (◀▶) to place the cursor at the item to set, then use the cross-shaped button (▲▼) to change the values.

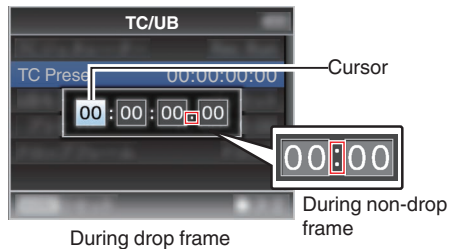

Memo : _____

- Press the [USER3] button to reset each digit to “0”. The cursor moves to the time digit (left).

3 Check the values and press the Set button (●).

- The time code is set and the screen returns to [TC/UB].
- To cancel the setting, press the [CANCEL/RESET] button.

4 Press the [MENU/THUMB] button.

Returns to the normal screen.

Setting Time Code without Opening the Menu

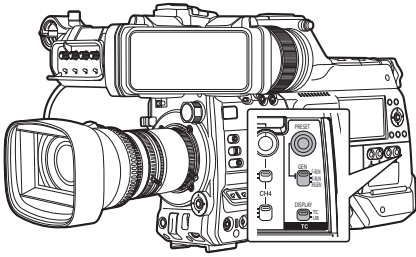

Memo : _____

- Settings cannot be made in the following cases.
 - When the [TC GEN] switch is set to “REGEN”.
 - Menu screen is displayed.
 - The camera recorder is not in the Camera mode.

Setting Time Code

- 1 Set the [TC DISPLAY] switch to “TC”.
- 2 Set the [TC GEN] switch to a setting other than “REGEN”.
- 3 Press the [TC PRESET] button.

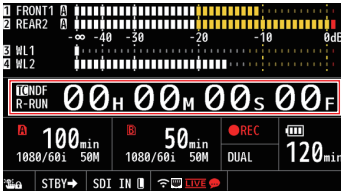

- 4 Set the time code (hour, minute, second, frame).

Use the cross-shaped button (◀▶) to place the cursor at the item to set, then use the cross-shaped button (▲▼) to change the values.

Memo : _____

- Press the [CANCEL/RESET] button to reset each digit to “0”. The cursor moves to the left.

- 5 Check the values and press the Set button (●).

- The time code is set and the screen returns to the normal screen.
- To cancel the setting, press the [TC PRESET] button.

Caution : _____

- When the camera recorder is switched to Media mode during editing, editing will be canceled and the screen will close.
- When editing the time code, operations of the buttons configured in [Camera Function] → [User Switch Set] are disabled.

Recording Time Code in Continuation of the Recorded Time Code on SD Card

This camera recorder is equipped with the time code reader.

- 1 Set the [TC GEN] switch to “REGEN”.
 - When the camera recorder enters from recording standby mode to recording mode, it reads the time code already recorded on the SD card and records the new time code in continuation of that value.
 - The same data as the user's bit already recorded on the SD card is recorded.

Memo : _____

- When the [TC GEN] switch is set to “REGEN”, the framing mode of the time code follows the settings in [TC/UB] → [Drop Frame] instead of the clip settings.
(☞ P127 [Drop Frame])

Setting the User's Bit

You can add the date, time or an 8-digit hexadecimal number as the user's bit to the recorded image.

Selecting a Recording Mode

Recording date/time information to the user's bit

- 1 Set [TC/UB] → [UB Mode] to "Date" or "Time", and press the Set button (●).

(☞ P127 [UB Mode])

The date or time information is recorded to the user's bit.

Memo : _____

- When "Date" or "Time" is set, [Preset] appears as "-" and cannot be set.
- "Time" is displayed in the 24-hour format.

Presetting the User's Bit

Recording arbitrary information (8-digit hexadecimal) to the user's bit

- 1 Set [TC/UB] → [UB Mode] to "Preset", and press the Set button (●).

(☞ P127 [UB Mode])



Memo : _____

- When the [TC GEN] switch is set to "REGEN", the parameter is displayed as "REGEN" and selection is disabled.

- 2 Select [TC/UB] → "Preset" and press the Set button (●).

The [Preset] setting screen appears.

- 3 Use the cross-shaped button (⬅➡) to place the cursor at the item to set, then use the cross-shaped button (⬆⬇) to change the values.

Numbers between 0 and 9 or alphabets between A and F can be specified for the user's bit.

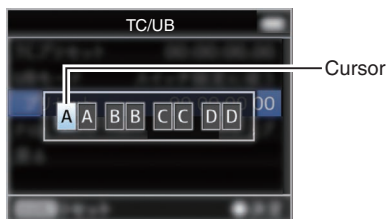

Memo : _____

- Press the [CANCEL/RESET] button to reset each digit to "0". The cursor moves to the left.

- 4 Check the values and press the Set button (●).

- The user's bit is set and the screen returns to [TC/UB].
- To cancel the setting, press the [CANCEL/RESET] button.

- 5 Press the [MENU/THUMB] button. Returns to the normal screen.

Setting User's Bit without Opening the Menu

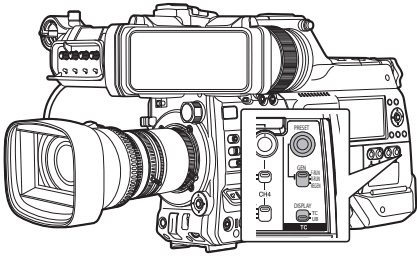

Memo : _____

- Settings cannot be made in the following cases.
 - When the [TC GEN] switch is set to "REGEN".
 - Menu screen is displayed.
 - The camera recorder is not in the Camera mode.

Setting the user's bit

- 1 Set the [TC DISPLAY] switch to "UB".
- 2 Set the [TC GEN] switch to a setting other than "REGEN".
- 3 Press the [TC PRESET] button.
- 4 Set the user's bit (numbers between 0 and 9, or alphabets between A and F).
Use the cross-shaped button (◀▶) to place the cursor at the item to set, then use the cross-shaped button (▲▼) to change the values.

Memo : _____

- Press the [CANCEL/RESET] button to reset each digit to "0". The cursor moves to the left.
- 5 Check the values and press the Set button (●).
 - The user's bit is set and the screen returns to the normal screen.
 - To cancel the setting, press the [TC PRESET] button.

Caution : _____

- When the camera recorder is switched to Media mode during editing, editing will be canceled and the screen will close.
- When editing the user's bit, operations of the buttons configured in [Camera Function] → [User Switch Set] are disabled.

Synchronizing the Time Code with an External Time Code Generator

This camera recorder comes with a [TC IN] terminal.

Connect a time code signal generator to the [TC IN] terminal to synchronize with the SMPTE/EBU LTC time code.

Memo : _____

- After synchronization (slave lock), the internal time code generator continues to run even if there is no input from the external time code generator.

Connection

Setting up the external time code generator as a master device

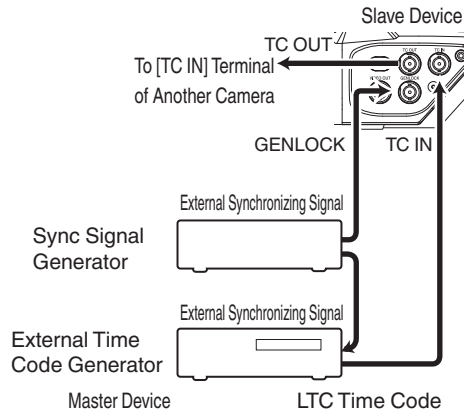

- 1 Input the external synchronizing signal to the external time code generator and the [GENLOCK] terminal of this camera recorder.

Memo : _____

- BB signals or HDTV tri-level synchronizing signals are used as the external synchronizing signal.
- If the power of the camera recorder is turned on/off during input of external synchronizing signals, the screen may appear disrupted for a few seconds. This is not a malfunction.

- 2 Input the SMPTE/EBU LTC time code from the external time code generator to the [TC IN] terminal of this camera recorder.

Connecting multiple devices, with one as the master unit and the others as slave units

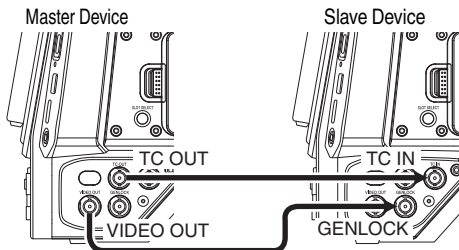

- 1 Connect the [TC OUT] terminal of the master device with the [TC IN] terminal of the slave device.
- 2 Connect the [VIDEO OUT] terminal of the master device with the [GENLOCK] terminal of the slave device.

Settings and Operation of the Camera Recorder

- 1 Set to Camera mode.
(P20 [Operation Modes])
- 2 Set [A/V Set] → [Video Set] → [Genlock Input] to “GENLOCK”.
(P138 [Genlock Input])
- 3 Set the [TC GEN] switch to “F-RUN”.
- 4 Set LCD monitor or viewfinder to Display screen.
- 5 Set the external time code generator or the master device, and run the time code.
 - When the built-in time code generator is synchronized with the external time code data input, the icon on Display screen lights up.
 - When time code is not synchronized or time code input is not available, the icon goes out.

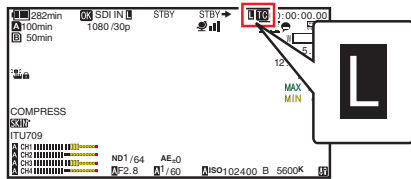

Memo : _____

- The built-in time code generator will continue operation even when the master device is disconnected after synchronization.
- User's bit will become data in the master device.

Setting Zebra Pattern

When the luminance level range for displaying zebra patterns is specified, diagonal lines (zebra pattern) are displayed at areas with the specified luminance levels during shooting.

1 Set the zebra display pattern.

Select the display pattern in [LCD/VF] → [Shooting Assist] → [Zebra].
(☞ P129 [Zebra])

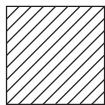

Zebra 1 Display Example

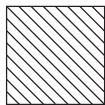

Zebra 2 Display Example

2 Specify the brightness (luminance) level range for displaying zebra pattern.

Set the maximum brightness limit in [LCD/VF] → [Shooting Assist] → [Zebra] → [Top 1]/[Top 2], and the minimum brightness limit in [Bottom 1]/[Bottom 2].

Item	Settings	Options
Top 1	Maximum brightness limit for displaying Zebra 1	5%, 10% to 95%, 98%, 100%, Over
Bottom 1	Minimum brightness limit for displaying Zebra 1	0%, 5% to 95%, 98%, 100%
Top 2	Maximum brightness limit for displaying Zebra 2	5%, 10% to 95%, 98%, 100%, Over
Bottom 2	Minimum brightness limit for displaying Zebra 2	0%, 5% to 95%, 98%, 100%

Memo : _____

- When [Zebra] is set to “1 Pattern”, “Top 2” and “Bottom 2” cannot be selected.
- If the area specified by two zebra patterns overlaps, Zebra1 pattern will be displayed.
- The timing to detect the zebra pattern display can be configured only when “J-Log1” or “HLG” is selected in [Color Space] and “Cam” or “Cam + Return” is selected in [Convert to ITU709].
(☞ P118 [Color Space])
(☞ P129 [Detect])

3 Display the zebra pattern.

- When the viewfinder is connected, the zebra pattern is displayed when the [ZEBRA] switch is set to “ON” or push down to “MOMENT”.
- When the viewfinder is not connected, the zebra pattern is displayed using the user button assigned with “Zebra”.



During zebra pattern display,  (zebra icon) is displayed on the display screen in Camera mode.

Memo : _____

- When the viewfinder is connected, priority is given to the [ZEBRA] switch on the viewfinder so the user button assigned with “Zebra” will not function.

Setting Spot Meter

The brightness of the object during shooting is displayed.

This function is useful when setting video or stage lighting or when specifying camera exposure.

A cursor indicating the location and the brightness (%) of that location are displayed in the images shown on the LCD monitor and viewfinder screen.

- Zebra patterns display the brightness of output video signals.

(P82 [Setting Zebra Pattern])

- This function allows you to check the brightness of input images from the lens without depending on image processing such as gamma curve.
- When [Color Space] is set to a value other than “HLG” and “J-Log1”, the dynamic range of the camera recorder is max. 600% and a brightness range of 0% to 600% is displayed.

- The value of the spot meter changes according to the setting of [LCD/VF] → [Convert to ITU709]/[White Level] when [Color Space] is set to “HLG”.

When [Color Space] is set to “HLG” and [LCD/VF] → [Convert to ITU709]/[White Level] is set to “72.5%”, the dynamic range of the camera recorder is max. 687% and a brightness range of 0% to 687% is displayed.

- When [Color Space] is set to “J-Log1”, the dynamic range of the camera recorder is max. 800% and a brightness range of 0% to 800% is displayed.

Memo : _____

- Spot meter may not be consistent with the zebra display range.

1 Select one of the following from [Camera Function] → [User Switch Set] → [Spot Meter].

(P115 [Spot Meter])

Item	Settings	Color of Frame Indicating the Position
Max & Min	Displays the brightness (%) and positions of the brightest and darkest areas in the screen. Frames may also be stopped at the current positions.	<ul style="list-style-type: none"> • Max: Green • Min: Yellow
Max	Displays the brightness (%) and position of the brightest area in the screen. Frames may also be stopped at the current positions.	Green
Min	Displays the brightness (%) and position of the darkest area in the screen. Frame may also be stopped at the current positions.	Yellow
Manual	Displays the brightness (%) of the specified position.	Green (Blinks in green when specifying the position)

2 Assign the “Spot Meter” function to any of the user buttons.

(P45 [Assignment of Functions to User Buttons])

3 Press the user button that is assigned with “Spot Meter”.

The operation switches as below when the button is pressed.

When [Max & Min]/[Max]/[Min] is selected

- ① The cursors appear according to the setting when the button is pressed. Green and yellow frames appear, and the brightness levels of these areas are displayed.

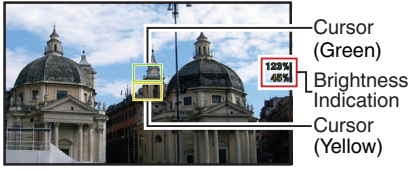

- ② Hold down the button in the state in ①, the positions of the brightest (Max) and darkest (Min) areas in the screen are automatically detected with regard to the changes of the object, and the brightness level of these areas are displayed.

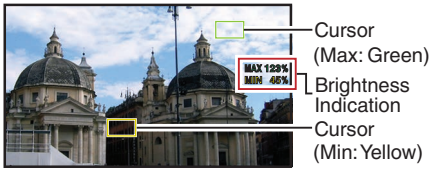

- ③ Pressing the button in the state in ② stops the automatic position detection. The frames are fixed at the stopped positions and the brightness levels are displayed.
- ④ By pressing the button, the cursors and brightness indication disappear.



When [Manual] is selected

- ① The brightness of the cursor position is displayed when the button is pressed.

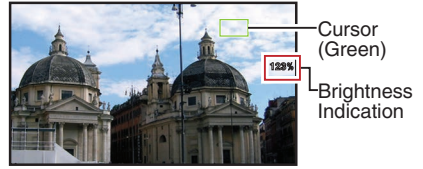

- ② By pressing the button, the cursors and brightness indication disappear.



- ③ Hold down the button in the state in ① or ②, the cursor blinks in green. Move the cursor with the cross-shaped button (▲▼◀▶) to specify the position to display the brightness. When you decide on the position, press the Set button (●) to confirm.

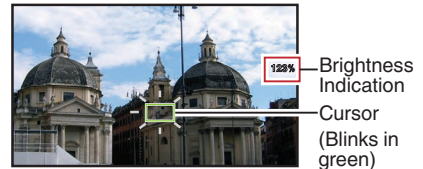

- ④ Frames are fixed at the stopped positions and the brightness is displayed.

Memo : _____

- When moving the cursor position, [Shutter]/[AE Level] control is disabled.
- When the brightness is 0 % in the entire screen, the frame is fixed in the center.



Acquiring Positioning Information by GPS **CHE**

CHU





This camera recorder comes with a built-in GPS function. The GPS function is able to record the positioning information. During playback, you can also display the recorded information on the playback screen.

(P101 [Playing back])

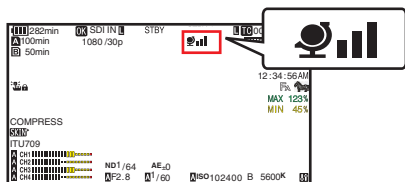
1 Set [System] → [GPS] to “On”.

- Positioning starts when the  icon on the display screen starts blinking.
- After positioning is complete, the  icon switches to a solid light and records the positioning information during shooting.
- The icon that appears on the screen changes according to the condition of signal reception from the GPS satellite.



Display	Reception Status	Positioning Status
 (Yellow)	[GPS] is set to “On”, but signal cannot be received	GPS signal cannot be received. UTC and positioning information cannot be obtained.
 (Blink)	GPS search in progress	UTC information can be obtained, but not positioning information.
 signal strength: weak	GPS reception in progress (signal strength: weak)	Receiving weak GPS signal. UTC and positioning information can be obtained and recorded.
 signal strength: medium	GPS reception in progress (signal strength: medium)	Receiving GPS signal. UTC and positioning information can be obtained and recorded.

Display	Reception Status	Positioning Status
	GPS reception in progress (signal strength: strong)	Receiving strong GPS signal. UTC and positioning information can be obtained and recorded.
(No display)	GPS function is turned off	The [GPS] item is set to “Off”.

Memo :

- If positioning cannot be performed after waiting for several minutes, this means GPS reception is poor, and there is difficulty in receiving data. Move to an open place with no obstructions. Otherwise, GPS information will not be recorded when shooting is performed.
- Signal may not be received depending on circumstances such as locations that are indoors or surrounded by tall buildings, or the geographical conditions. Precision error may occur in the position information depending on the conditions of reception.
- Even when positioning is in progress, information may be disrupted depending on the condition of signal reception.
- When [A/V Set] → [Video Set] → [SDI OUT1 Res.] is set to “1080p”, configuring [System] → [GPS] to “On” changes the setting to “1080i”.

Viewing Recorded Videos Immediately (Clip Review)

You can check (review) the last recorded video clip on the screen.

However, the video clip cannot be played back if the settings of the camera recorder are different from the video format (Resolution/Frame Rate/Bit Rate/SD Aspect) of the clip.

(P161 [A Resolution/ EXT Resolution])

(P161 [A Frame Rate/ EXT Frame Rate])

(P162 [A Bit Rate/ EXT Bit Rate])

(P163 [SD Aspect])

Memo : _____

- To use this function, assign “Clip Review” to any of the user buttons.

1 Press the user button assigned with the “Clip Review” function during standby (“STBY” is displayed).

Playback of the configured section starts.

Memo : _____

- The video clip is played back according to the setting in [Camera Function] → [User Switch Set] → [Clip Review]. By default setting (Last 5sec), the last 5 seconds of the clip is played back.
(P115 [Clip Review])
- When playback is complete, the camera recorder exits Clip Review and returns to “STBY” (recording standby) mode.

Caution : _____

- During Clip Review, only the [CANCEL/RESET] and [REC] buttons are enabled.
Press the [CANCEL/RESET] button to cancel clip review and return to “STBY” (recording standby) mode.
Press the [REC] button to cancel clip review and enter recording mode. It will take some time to start recording after the button is pressed.
- When the last clip is less than 5 seconds, the whole clip is played back.
- Only video clips in the currently selected slot can be reviewed.
- When there are no clips in the selected slot, Clip Review function is disabled.
- Clip Review is unavailable when Clip Continuous Rec is paused (“STBY**C**”, yellow text). To operate Clip Review, use the [CANCEL/RESET] button to set to “STBY**C**” (white text) first.
(P93 [Clip Continuous Rec])
- Clip Review is unavailable when the camera recorder is connected to an external equipment and the equipment is in recording state.
- Clip Review is unavailable when operating View Remote via network connection.
(P212 [View Remote Control and Camera Control Functions])
- Clip Review does not function during live streaming.
- Clip Review does not function while the record trigger is in the REC state.

Displaying the Video Signal Monitor

The video signal monitor can be displayed using the user button assigned with “Video Signal Monitor”. The display operation functions according to the setting in [Camera Function] → [User Switch Set] → [Video Signal Monitor].

Displaying the Vectorscope

Displays the saturation and hue of the video as a circle.

The vectorscope can be displayed using the user button assigned with “Video Signal Monitor”.

Displaying the Waveform

Displays the luminance signal of the video as a waveform.

The waveform can be displayed using the user button assigned with “Video Signal Monitor”.

Displaying the Histogram

The histogram shows the brightness distribution, and is employed mainly for checking the exposure of the image.

1 Set the histogram feature to ON.

The histogram can be displayed using the user button assigned with “Video Signal Monitor”.

2 Set the upper and lower limits of the histogram display.

After setting, the brightness level is displayed in red color.

Item	Settings	Options
Top	Sets the maximum brightness limit for changing the histogram display color	5% to 110% (in 5 % increments)
Bottom	Sets the minimum brightness limit for changing the histogram display color	0% to 105% (in 5 % increments)

■ When the upper limit is set to 110% and the lower limit to 0%



* The area in red is not displayed.

■ When the upper limit is set to 90% and the lower limit to 10%

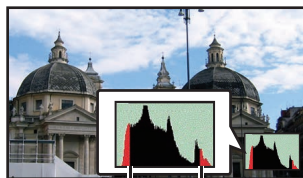

Bottom Top

How to read the histogram

- The vertical axis denotes the number of pixels.
- The horizontal axis denotes the pixel brightness.

Recording Simultaneously at Two Different Definitions

By setting [System] to “HD+Web”, you can record simultaneously at two different definitions.

- When HD+Web is selected:
 - Records a high-definition (HD) file to slot A and a web file to slot B at the same time.
 - Web files can be used as a proxy file for the HD file.

Memo : _____

- If a recordable SD card is inserted into only one of the slots, files will only be recorded to that slot.
- The [Rec Mode] is fixed at “Normal”.
- Clip Cutter Trig is disabled.
- [Slot Mode] cannot be selected.
- Clip Review can only be performed for slot A. (“No Media” appears if there is no card in slot A while a card is inserted into slot B.)
- Playback of web files is only possible from slot B when “HD+Web” is selected.

Dual Rec

- If both the slots are loaded with recordable cards in the Dual Rec mode ([Slot Mode] is set to “Dual”), pressing the [REC] button starts recording simultaneously to the media in both the slots.
- The clips recorded to the media in both the slots are identical, and two clips of the same content can be created only on this camera recorder. (P164 [Slot Mode])

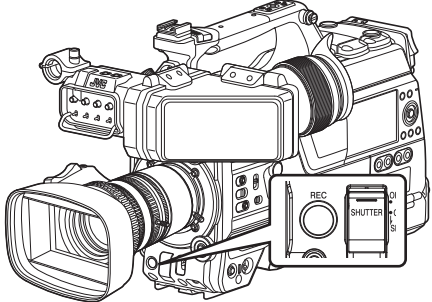

Series Rec

- Series Rec mode is specified in the factory default. ([System] → [Record Set] → [Slot Mode] is set to “Series”.) (P164 [Slot Mode])
- If both the slots are loaded with recordable cards, pressing the [REC] button starts recording only to the media in the selected slot. When the remaining space in the selected media runs out, recording continues by automatically activating the media in the other slot.
- There is no indication on the display screen when the Series Rec mode is set.

Setting to Dual Rec Mode

- 1 Set [System] → [Record Set] → [Slot Mode] to “Dual”. (P164 [Slot Mode]) “DUAL” appears on the enlarged display screen.

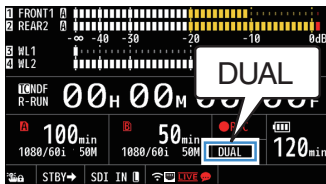

2 Start recording.

- Insert recordable media in both slots, and press the [REC] button.
- In the Dual Rec mode, recording to the media in both slots starts at the same time.
- Both the card slot marks turn red, and the status indicators of both the card slots also light up in red.

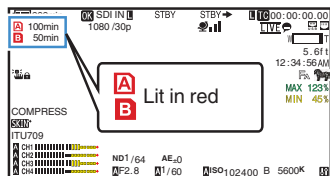

3 Stop recording.

- Press the [REC] button again.
- Recording to both slots stops, and both the card slot marks turn white.
- The same clips are recorded to both cards.

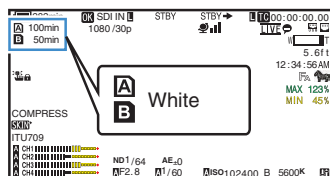

Memo :

- During recording in the Dual Rec mode, both the card slot marks light up in red.
- During recording in the Dual Rec mode to two cards with a different amount of remaining space, if the space of one card runs out, recording to both slots will stop automatically. After recording stops, recording automatically resumes for the card with remaining space. Although the clips are separated in this case, the clips can be seamlessly joined by arranging them on the timeline of the editing software since they are recorded seamlessly.
- If the last clip on the cards that are inserted in the two slots are different from each other, and the time code operating mode is set to "REGEN", the REGEN mode for the selected card slot will be enabled in the next recording.

Caution :

- To perform recording in the Dual Rec mode, it is recommended that you start recording by making use of two cards with the same capacity and from the formatted state.
- You can combine the use of the Dual Rec mode with a special recording mode. While in the Dual Rec mode, you can also set [Rec Mode] to "Normal", "Pre Rec", "Clip Continuous", "Interval Rec", or "Frame Rec".
(P92 [Special Recording])
(P163 [Rec Mode])
- When both slots are inserted with recordable cards, the Dual Rec (simultaneous recording) operation can be performed. If a recordable media is only inserted in one of the slots, you can also start recording with one card.
- In the Dual Rec mode, continuous recording by switching from one slot to another cannot be performed. Continuous recording will not be performed if a recordable media is inserted in a slot after recording to the other slot has started.
- When recording to one slot is in progress with the recorder set to the Dual Rec mode, inserting a recordable media to the other slot does not enable the Dual Rec operation. To perform the Dual Rec operation, stop recording temporarily (excluding pausing recording in the Clip Continuous Rec mode), and start again.
- When one of the cards is accidentally removed while recording is in progress in the Dual Rec mode, recording to the card in the other slot will continue. However, repair of the accidentally removed card by the recovery function may fail.
- If an error occurs on one of the cards while recording is in progress in the Dual Rec mode, recording of the erroneous card stops, while that of the other card continues.
- Operations on clips recorded in the Dual Rec mode, such as clip deletion in the Media mode or appending of OK marks, can only be performed on the card in the selected slot.

Backup Rec

- Backup Rec mode enables backup recording to the media in Slot B or the expansion slot by starting or stopping recording to Slot B or the expansion slot independently of control using the [REC] button.
 - Start or stop the recording using [System] → [Record Set] → [Slot Mode] → [Backup Rec] or press the user button that is assigned with “Backup Trig”.
- (☞ P164 [Slot Mode])
 (☞ P113 [User Switch Set Item])

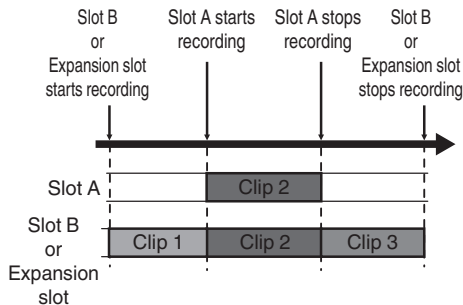

Memo : _____

- During the Backup Rec mode (when [Slot Mode] is set to “Backup B” or “Backup EXT”), you can control recording to the 2 slots at different timings, and backup recording can only be performed on this camera recorder.
- (☞ P164 [Slot Mode])
- By setting Slot B or the expansion slot to perform recording at all times (backup recording) and using the [REC] button to start/stop recording of only the required scenes in Slot A, you do not have to worry about having to pause recording and missing out on the important scenes as a result.
- It is recommended to use a media with high capacity in slot B.
- Backup cannot be selected when [A Format] is configured to “Exchange” (U model) or “MP4” (E model).

1 Set [System] → [Record Set] → [Slot Mode] to “Backup B” or “Backup EXT”.

(☞ P164 [Slot Mode])
 “BACKUP” appears on the enlarged display screen.

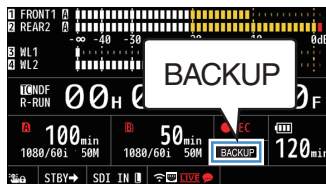

2 Start backup recording (to Slot B or the expansion slot).

- Select “REC” in [System] → [Record Set] → [Slot Mode] → [Backup Rec] and press the Set button (●).
- (☞ P164 [Slot Mode])
- You can also press the user button that is assigned with “Backup Trig”.
- (☞ P113 [User Switch Set Item])
- Backup recording starts, and video and audio are recorded to Slot B or the expansion slot.
- The card slot mark of slot B turns red (selected state), and the status indicator of slot B also blinks in red.

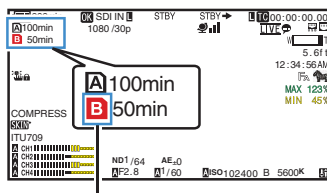

Red (selected)

3 Start normal recording (normal recording into slot A).

- Press any of the [REC] buttons.
- Recording into the media in slot A starts.
(The characters “●REC” appear in red.)
- The card icon of slot A turns red (unselected state), and the status indicator of slot A blinks in red.

Red (not selected)

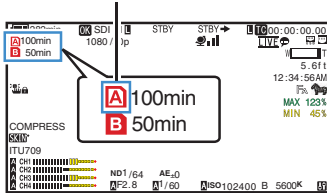

4 Stop normal recording.

- Press any of the [REC] buttons again.
- Recording to slot A stops, and the card slot mark of slot A turns white (unselected state).
- The characters “●REC” (red) changes back to “STBY” (white).
- The status indicator of slot A goes out.

White (not selected)

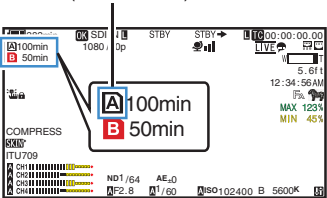

5 Stop backup recording.

- Select [STBY] in [System] → [Record Set] → [Slot Mode] → [Backup Rec] and press the Set button (●).
- (☞ P164 [Slot Mode])
- You can also press the user button that is assigned with “Backup Trig”.
- (☞ P113 [User Switch Set Item])
- Recording to Slot B or the expansion slot stops, and the card slot mark of Slot B or the expansion slot turns white (selected state).
- The status indicator of slot B lights up in green.

White

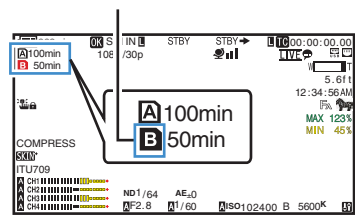

Memo : _____

- When one of the media has run out of free space during backup recording, recording will stop only for the card that is full.
- When recording to each slot is stopped, recording in the REGEN mode will be enabled for the card slot in which recording started.
- When recording is started in the other slot while recording to one slot, the clip being recorded is split and simultaneous recording to the other card starts.
- When either normal recording or backup recording is stopped while both are in progress, the clip in the slot where recording is still ongoing will be split.
- Although the clips are separated during recording the clips can be seamlessly joined by arranging them on the timeline of the editing software since they are recorded seamlessly.
- Clip Cutter Trig cannot be performed during backup recording.
(☞ P96 [Splitting the Clips Freely (Clip Cutter Trig)])
- When [Slot Mode] is set to “Backup **B**” or “Backup **EXT**”, [Rec Mode] can only be set to “Normal”.
(☞ P163 [Rec Mode])

Special Recording

Besides the normal recording mode, four special recording methods are available in this camera recorder. They are Pre Rec, Clip Continuous, Frame Rec and Interval Rec.

Select a mode from [System] → [Record Set] → [Rec Mode].

( P163 [Rec Mode])

Memo : _____

- Special recording cannot be selected when [System] → [Record Set] → [Record Format] → [System] is set to “HD+Web” or “High-Speed”.

Pre Rec

- By setting the number of seconds in the [Pre Rec Time], you can start recording video and audio before actual recording starts based on the [Pre Rec Time] setting.
- When starting actual recording while the camera recorder is in Recording Standby (STBY \mathbf{P}) mode, you can start recording a few seconds earlier based on the [Pre Rec Time] setting.
- Using Pre Rec allows you to record a complete event without missing the initial scenes even if you start the recording late.

Memo : _____

- Pre Rec Time can be set in [System] → [Record Set] → [Rec Mode] → [Pre Rec Time].

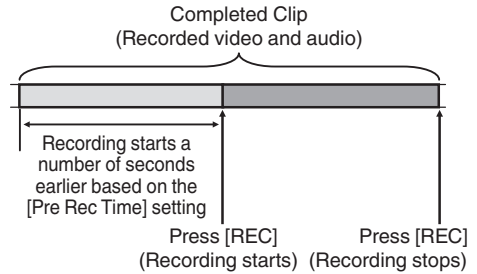

1 Set [Rec Mode] to “Pre Rec”.

( P163 [Rec Mode])

- Set [System] → [Record Set] → [Rec Mode] to “Pre Rec”.
- The display changes (“STBY” → “STBY \mathbf{P} ”).

2 Press the [REC] button to start recording in Pre Rec mode.

- The display changes (“STBY \mathbf{P} ” → “●REC \mathbf{P} ”) and the card slot status indicator lights up in red.
- Press the [REC] button again to pause recording. The display changes (“●REC \mathbf{P} ” → “STBY \mathbf{P} ”) and the card slot status indicator lights up in green.

Caution : _____

- When the interval between start and stop recording is short, “STBY \mathbf{P} ” may not be displayed immediately after recording is complete.
“●REC \mathbf{P} ” → “STBY \mathbf{P} ” (“STBY” blinks in red) → “STBY \mathbf{P} ” is displayed.
- When the SD card becomes full during recording, recording stops and “STOP” is displayed.
- In the following cases, video and audio before the specified Pre Rec time may not be recorded even if recording starts.
 - Immediately after power on
 - Immediately after recording stops
 - Immediately after switching from Media mode to Camera mode
 - Immediately after setting [Rec Mode]
 - Immediately after the end of Clip Review
 - Immediately after changing file format
 - Immediately after changing video format

Clip Continuous Rec

- In normal recording, when the recording stops, the image, audio, and accompanying data from the start till the end of the recording are recorded as one “clip” on the SD card.
- This mode allows you to consolidate several rounds of “startstop recording” into one clip.

Example:

In normal recording, three clips are generated as Recording 1, Recording 2, and Recording 3.

However, recording in this mode generates only one clip.

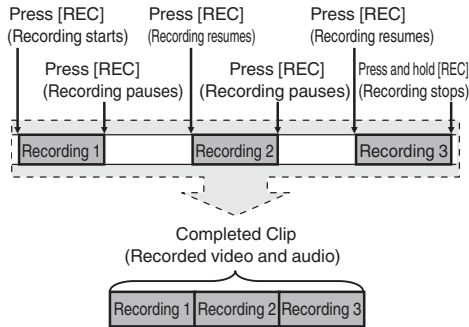

1 Set “Rec Mode” to “Clip Continuous”.

(P163 [Rec Mode])

- Set [System] → [Record Set] → [Rec Mode] to “Clip Continuous”.
- The display changes (“STBY” → “STBY \square ”).

2 Start recording. (Recording 1)

- Press the [REC] button to start recording in Clip Continuous mode.
- The display changes (“STBY \square ” → “●REC \square ”) and the card slot status indicator lights up in red.

3 Pause recording.

- Press the [REC] button again to pause recording. The display changes (“●REC \square ” → “STBY \square ” (yellow text)).
- The card slot status indicator remains lighted in red.

Memo : _____

- When the [CANCEL/RESET] button is pressed while the camera recorder is paused (STBY \square), the display changes (“STBY \square ” (yellow text) → “STBY \square ” (blinking yellow text) → “STBY \square ” (white text)), and a “clip” is generated. The card slot status indicator lights up in green.

4 Resume recording. (Recording 2)

- Press the [REC] button again to resume recording. The display changes (“STBY \square ” (yellow text) → “●REC \square ” (white text)).
- The card slot status indicator remains lighted in red.

5 Pause recording.

- Press the [REC] button again to pause recording. The display changes (“●REC \square ” → “STBY \square ” (yellow text)).
- The card slot status indicator remains lighted in red.

6 Resume recording. (Recording 3)

- Press the [REC] button again to resume recording. The display changes (“STBY \square ” (yellow text) → “●REC \square ”).
- The card slot status indicator remains lighted in red.

7 Press and hold the [REC] button.

- Recording stops and the display changes (“●REC \square ” → “STBY \square ”). A “clip” is generated.
- The card slot status indicator lights up in green.

8 Press the [REC] button again.

- The display changes (“STBY \square ” → “●REC \square ”) and the card slot status indicator lights up in red.
- A new “clip” is generated from here.

Memo : _____

- The following operations cannot be performed while recording is paused (STBY \square , yellow text).
 - Clip Review operation (P86 [Viewing Recorded Videos Immediately (Clip Review)])
 - Switching SD card slots
 - Switching operation mode (P20 [Operation Modes])
- Files are split into sizes of 4 GB (or 30 minutes) regardless of the menu settings.

Caution : _____

- Do not remove the SD card during recording (RECC, red text) or recording pause (STBY \square , yellow text).
- To remove the SD card in the “Clip Continuous” mode, press the [CANCEL/RESET] button, check that “STBY \square ” (white text) is displayed and the card slot status indicator lights up in green before you remove the card.
- When the SD card becomes full during recording, recording stops and “STOP” is displayed.
- When the [POWER ON/OFF] switch is turned off during recording or recording pause, recording stops and power is cut off after a clip is generated.
- If the power is cut off due to low battery power, a proper clip may not be generated.

Frame Rec

In normal recording, when the recording stops, the image and accompanying data from the start till the end of the recording are recorded as one “clip” on the SD card.

In this mode, recording starts with every press of the [REC] button, and only the specified number of frames is recorded.

The recording can be written to the media as a single clip until it is stopped.

Memo : _____

- Audio will not be recorded.
- Until a specified amount of recordings is accumulated, the file cannot be written to the media.
- If the specified amount is not reached when recording is stopped, normal recording is performed and frames are added to the ending of the clip until the amount is reached. (Padding)
- After the specified number of frames is recorded and written to the media, recording will be performed until the same number is accumulated again.

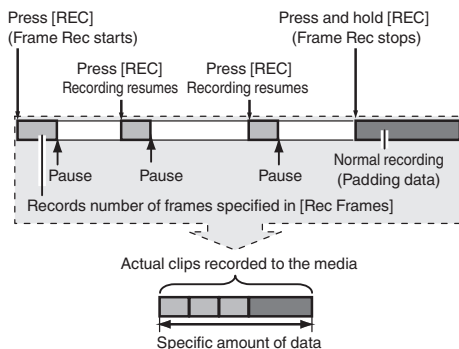

1 Set [Rec Mode] to “Frame Rec”.

- Set [System] → [Record Set] → [Rec Mode] to “Frame Rec”.

(P163 [Rec Mode])

- The display changes (“STBY” → “STBY \square ”).

2 Set the number of frames to record in [Rec Frames].

- To configure the setting, go to [System] → [Record Set] → [Rec Mode] → [Rec Frames]. (P163 [Rec Frames])

3 Start recording.

- Press the [REC] button to record only the number of frames specified in [Rec Frames] and pause.
- The display changes (“STBY” → “●REC” → “STBY” (yellow text)).
- The card slot status indicator lights up in green.

4 Repeat Frame Rec.

- Press the [REC] button again to record only the number of frames specified in [Rec Frames] and pause.
- The display changes (“STBY” → “●REC” → “STBY” (yellow text)).
- Frame Rec continues until the recording is stopped (step 5).

5 Press and hold the [REC] button.

- The card slot status indicator lights up in green.

Caution :

- Do not remove the SD card during recording (“●REC”, red text) or recording pause (“STBY”, yellow text).
- To remove the SD card during Frame Rec, press the [CANCEL/RESET] button, check that “STBY” (white text) is displayed and the card slot status indicator lights up in green before you remove the card.
- When the [TC GEN] selection switch is set to “F-RUN”, the time code will be recorded in “R-RUN”.
- Audio cannot be recorded. The audio level meter is grayed out. (P171 [Audio Level Meter])

Interval Rec

In normal recording, when the recording stops, the image and accompanying data from the start till the end of the recording are recorded as one “clip” on the SD card.

In this mode, recording and pause are performed repeatedly at the specified time interval. Only the specified number of frames is recorded.

The recording can be written to the media as a single clip until it is stopped.

Memo :

- Audio will not be recorded.
- Until a specified amount of recordings is accumulated, the file will not be written to the media.
- After the specified number of frames is recorded and written to the media, recording will be performed until the same number is accumulated again.
- If the specified amount is not reached when recording is stopped, normal recording is performed and frames are added to the ending of the clip until the amount is reached. (Padding)

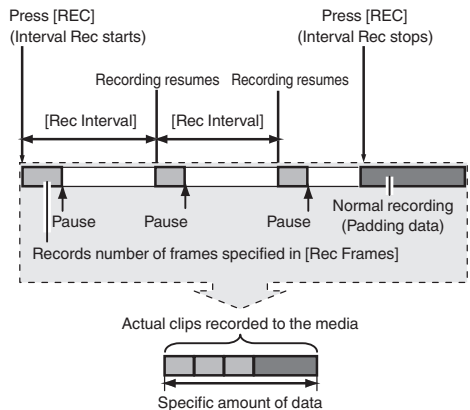

1 Set [Rec Mode] to “Interval Rec”.

- Set [System] → [Record Set] → [Rec Mode] to “Interval Rec”.

(P163 [Rec Interval])

- The display changes (“STBY” → “STBY”).

2 Set the number of frames to record in [Rec Frames].

To configure the setting, go to [System] → [Record Set] → [Rec Mode] → [Rec Frames]. (P163 [Rec Frames])

3 Set the time interval to start recording in [Interval Rec].

To configure the setting, go to [System] → [Record Set] → [Rec Mode] → [Rec Interval].
(☞ P163 [Rec Interval])

4 Start recording.

- Press the [REC] button to record only the number of frames specified in [Rec Frames] and pause.
- After the specified time in [Rec Interval] has passed, recording starts again to record only the number of frames specified in [Rec Frames] and pause.
- Interval Rec continues until the recording is stopped.

The display changes (“STBY” → “●REC” → “STBY” (red text) → “●REC” → “STBY” (red text)).

- The card slot status indicator lights up in red.

5 Press the [REC] button.

- The card slot status indicator lights up in green.
- The display becomes “STBY”.

Caution :

- Do not remove the SD card during recording (●REC, red text) or recording pause (STBY, yellow text).
- To remove the SD card during Interval Rec, press the [CANCEL/RESET] button, check that “STBY” (white text) is displayed and the card slot status indicator lights up in green before you remove the card.
- When the [TC GEN] selection switch is set to “F-RUN”, the time code will be recorded in “R-RUN”.
- Audio cannot be recorded. The audio level meter is grayed out.
(☞ P171 [Audio Level Meter])

Splitting the Clips Freely (Clip Cutter Trig)

You can split the clips freely without having to stop recording during shooting.

1 Assign the “Clip Cutter Trig” function to any of the user buttons.

(☞ P45 [Assignment of Functions to User Buttons])

2 Press the user button that is assigned with “Clip Cutter Trig” during shooting.

A clip cut icon (●✂) appears on the display screen for 3 seconds, and the clip is split.

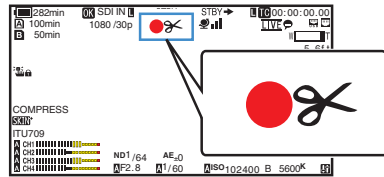

Memo :

- Clips cannot be split again for a few seconds after the operation is performed.
- This item cannot be used when [Slot Mode] is set to “Backup B” or “Backup EXT”.
- This item cannot be used when [Rec Mode] is set to a value other than “Normal” or “Pre Rec”.
(☞ P163 [Rec Mode])
- The split clips are recorded seamlessly without interruptions in the video.
- When Exchange (U model) or MP4 (E model) is selected, the clip cutter function cannot be used.

Playing Recorded Clips

To play back clips recorded on SD cards, switch to the Media mode.

Press and hold the [CAM/MEDIA] selection button in the Camera mode to enter the Media mode. A thumbnail screen of the clips recorded on the SD card is displayed.

You can play back the selected clip on the thumbnail screen.

Memo : _____

- When an SD card without any clips is inserted, “No Clips” is displayed.

Operation Buttons

Use the operation buttons on the side control panel or front side of the camera recorder to operate the thumbnail screen.

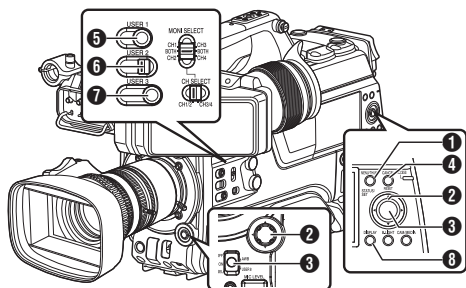

- [MENU/THUMB] Button**
 - Displays the menu.
 - Press this button to close the menu screen during menu display and return to the thumbnail screen.
- Cross-Shaped Button (▲▼◀▶)**
 - Moves the cursor.
- [STATUS/SET] (Play) Button**
 - Sets the values and items. (Confirm)
 - Plays back the selected clip.
- [CANCEL/RESET] (Stop) Button**
 - Cancels settings and returns to the previous screen.
- [USER1] Button**
 - Switches the OK mark of the clip selected by the cursor.
 - If an OK mark has been appended, it will be deleted. Otherwise, an OK mark will be appended.

- [USER3] Button**
 - Switches the selection status of the clip selected by the cursor.
 - Clips being selected are displayed with check mark.
- [USER4] Button**
 - Enters the action selection screen.
- [DISPLAY] Button**
 - Switches to “Standard Screen”, “Detailed Screen” or “Media Information Screen”.

Thumbnail Screen

- “Standard Screen” and “Detailed Screen” are available.
- Use the [DISPLAY] button to switch between the screens.
- Thumbnails are displayed in order of recording from the oldest to most recent.

Standard screen

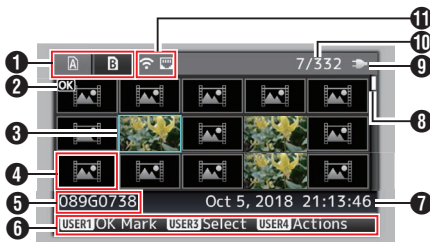

- SD Card Information**
 - Displays the status of the inserted SD card, selected SD card, write-protect switch, and the need for restoring.
 - Use the [SLOT A/B] switch to switch slots. Clips in slot A and B cannot be displayed at the same time.
 - A** : Write-protect switch of the SD card in slot A is set.
 - B!** : SD card in slot B needs to be restored or formatted, or is an unsupported SD card.
- Clip Mark**
 - Displays the clip information (properties).



- OK Mark**
 - Clip is appended with OK mark.

Memo : _____

- Clips appended with OK marks cannot be deleted on the camera recorder.
-
- ② Continued From Mark
This mark indicates that the current clip is continued from another SD card when recording is divided and made on several SD cards.
 - ③ Uneditable Mark
• This mark indicates that an OK mark cannot be appended to or deleted from the clip, and the clip cannot be deleted.
 - ④ Continue Mark
This mark indicates that recording of the current clip is continued to another SD card when recording is divided and made on several SD cards.
 - ⑤ Check Mark
• A green check mark is displayed when the clip is selected.
• Magenta and gray check marks are displayed in multiple selection mode.
(☞ P104 [Selecting and Performing Operations on Multiple Clips])
 - ③ Cursor
Clip to be worked on. Use the cross-shaped button (▲▼◀▶) to move the cursor.
 - ④ Thumbnail Substitution Display



- ① A clip with corrupted management information. It cannot be played back even if you press the Set (Play) button.
- ② A clip that cannot be played back nor displayed in thumbnail with the current video format settings. It cannot be played back even if you press the Set (Play) button.

Memo : _____

- Dependent on the settings for [System] → [Record Set] → [Record Format] → [System]/[A Resolution]/[B Resolution]/[A Frame Rate]/[B Frame Rate]/[A Bit Rate], and [B Bit Rate].
(☞ P160 [System])
(☞ P161 [A Resolution/ EXT Resolution])
(☞ P161 [A Frame Rate/ EXT Frame Rate])
(☞ P162 [A Bit Rate/ EXT Bit Rate])
-
- ⑤ Clip Name
The file name (clip number) of the selected clip is displayed.
 - ⑥ Operation Guide
• Displays a guide for the current operation buttons.
• The action selection screen is displayed when the [USER4] button is pressed.
(☞ P99 [Actions])
 - ⑦ Recording Start Time
Displays the recording start time of the clip.
- Memo : _____
- The date/time display is dependent on the settings in [System] → [Date Style]/[Time Style].
(☞ P159 [Date Style])
(☞ P159 [Time Style])
-
- ⑧ Scroll Bar
• Indicates the scroll position.
• Black space below the scroll bar (white) indicates that there are more pages.
• When the scroll bar (white) is at the bottom, this indicates the last page.
 - ⑨ Remaining Battery Power
(☞ P36 [Power Status Display])
 - ⑩ Number of Clips
• If none of the clips are selected, the “running number/total number of clips” of the clip to be displayed appears.
• Even if only one clip is selected, the number of selected clips in the current slot is displayed.
 - ⑪ Network Connection Icon
• The network connection status is displayed.

Detailed screen

* Items that are common with the Standard screen will not be described. Refer to “[Standard screen] (P 97)”.

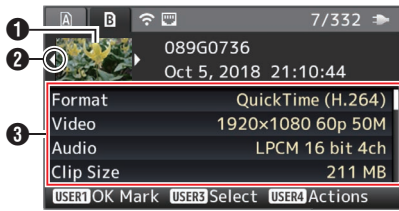

- 1 **Thumbnail**
Thumbnail of the clip selected by the cursor.
Use the cross-shaped button (◀▶) to move the cursor.
- 2 **Scroll Mark (◀▶)**
 - If there are previous clips, ◀ appears on the left.
 - If there are more clips, ▶ appears on the right.
 - The marks will not be displayed if there are no clips before and after the current clip.
- 3 **Metadata**
Metadata of the clip pointed by the cursor.
You can use the cross-shaped button (▲▼) to scroll.

Actions

The action selection screen is displayed when the [USER4] button is pressed.

The following operations can be performed.

Item	Description
Select All Clips	Selects all clips.
Select OK Marked	Selects all clips appended with OK mark.
Select Range	Specifies the range when selecting multiple clips. (P104 [Selecting Multiple Clips Randomly])
Deselect All	Clears all clip selections.
Add OK Mark	Appends an OK mark. <ul style="list-style-type: none"> • This Clip: Appends an OK mark to the clip pointed by the cursor. • Selected Clips: Appends an OK mark to the clips selected (appended with check mark). • All Clips: Appends an OK mark to all clips.
Delete OK Mark	Deletes the OK mark. <ul style="list-style-type: none"> • This Clip: Deletes the OK mark of the clip pointed by the cursor. • Selected Clips: Deletes the OK mark of the clips selected (appended with check mark). • All Clips: Deletes the OK mark of all clips.

Item	Description
FTP Upload	Uploads a clip to the FTP server. <ul style="list-style-type: none"> • This Clip: Uploads the clip pointed by the cursor. • Selected Clips: Uploads the clips selected (appended with check mark). • All Clips: Uploads all clips.
Delete Clips	Deletes clip. However, clips with OK mark cannot be deleted. <ul style="list-style-type: none"> • This Clip: Deletes the clip pointed by the cursor. • Selected Clips: Deletes the clips selected (appended with check mark). • All Clips: Deletes all clips.
Trim This Clip	Trims the clip pointed by the cursor.

Memo : _____

- The object of action is the clip of the current slot being displayed.
- [Selected Clips] cannot be performed if there are no selected (appended with check mark) clips.
- [This Clip] cannot be performed if there are more than one selected (appended with check mark) clips.
- If the write-protect switch of an SD card is set, OK mark cannot be appended or deleted, and the clips cannot be deleted and trimmed.

Playing back

Use the operation buttons on the side control panel of the camera recorder to play back.

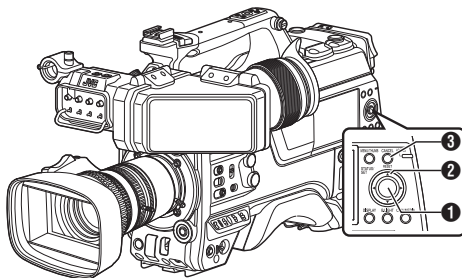

- 1 [STATUS/SET] Button (●)
 - Plays back/pauses the clip pointed by the cursor.
 - You can press the cross-shaped button (◀▶) to perform frame-by-frame forward playback during pause mode.
- 2 Cross-shaped Button (▲▼◀▶)
 - [▲/▼] Button: Skips in the reverse or forward direction.
 - [◀▶] Button:
 - During Playback: Fast forwards in the reverse or forward direction.
 - While paused: Frame-by-frame playback in the reverse or forward direction.
- 3 [CANCEL/RESET] Button

Stops playback.

1 In the thumbnail screen, move the cursor to the clip to be played back.

Move the cursor to the clip to be played back using the cross-shaped button (▲▼◀▶).

2 Press the [STATUS/SET] button (●). Playback of the selected clip starts.

Audio Output during Playback

- You can confirm the playback sound from the monitor speaker, or the headphone connected to the [PHONE] terminal. When a headphone is connected to the [PHONE] terminal, sound cannot be output from the monitor speaker. (P190 [Connecting the Headphone])
- Adjust the volume of the monitor speaker or headphone using the [MONITOR] volume adjustment knob.

Time Code Playback

Time code or user's bit recorded on an SD card can be displayed on the LCD monitor and viewfinder.

Memo : _____

- The time code is also superimposed on the video signal output from the [HD/SD SDI OUT 1/2] terminal.
- If a section without time code is played back, the time code will stop. However, playback will continue.

Displaying Information during Shooting

Pressing the [DISPLAY] button during playback displays the display screen.

Pressing the [USER4] button during shooting switches the display information between camera information display, GPS display and turning off the display.

- The GPS display displays information on the recording location of the video being played back only when GPS information has been recorded.
- Camera information display displays only information of Gain, Iris, Shutter and White Balance that have been recorded.

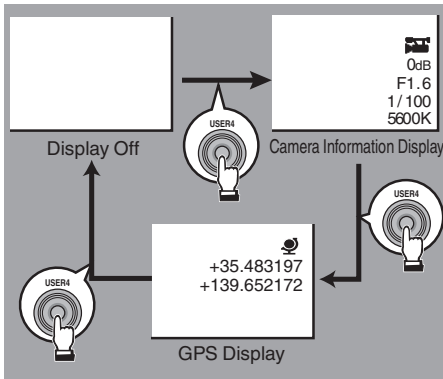

Memo : _____

- Trimming information is displayed while trimming is in progress. In this case, pressing the [USER4] button does not switch the display.

Deleting Clips

Delete clip.

Memo : _____

- Clips appended with OK marks cannot be deleted on the camera recorder.
- Read-only clips can be deleted on a PC.

Deleting One Clip

Delete the clip (one clip) pointed by the cursor in [Delete Clips] → [This Clip] in the menu.

Memo : _____

- Clips with OK mark cannot be deleted.

During Thumbnail Screen

- 1 **Move the cursor to the clip to be deleted.**
Move the cursor to the clip to be deleted using the cross-shaped button (▲▼◀▶).

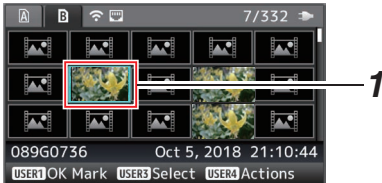

- 2 **Press the [USER4] button.**
The action selection screen is displayed.
- 3 **Select [Delete Clips] → [This Clip] and press the Set button (●).**
A screen to confirm deletion appears.

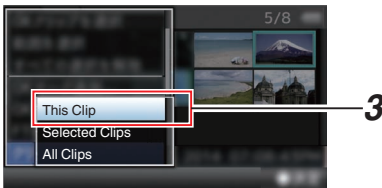

- 4 **Select [Delete] using the cross-shaped button (▲▼), and press the Set button (●).**
Deleting starts.

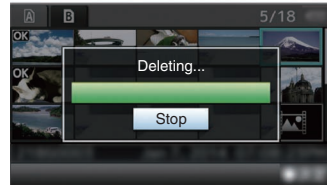
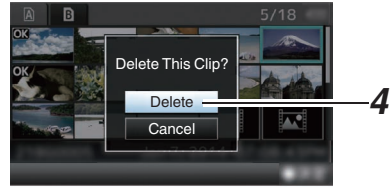

Selecting and Deleting Multiple Clips

To select and delete multiple clips, refer to "[Selecting and Performing Operations on Multiple Clips]" (P 104).

Deleting All Clips

Delete all clips that are displayed.

- 1 **Press the [USER4] button.**
The action selection screen is displayed.
- 2 **Select [Delete Clips] → [All Clips].**
A screen to confirm deletion appears.
- 3 **Select [Delete] and press the Set button (●).**
Deleting starts.

Memo : _____

- The time taken to delete clips depends on the number of clips to be deleted.

Appending/Deleting OK Mark

- You can append OK marks to the clips for important scenes.
- Clips appended with OK marks cannot be deleted, thus protecting the important clips.
- When the camera recorder is in Media mode, you can delete the OK marks appended during recording, or append/delete OK marks after shooting.

During Thumbnail Screen

1 Press the [USER1] button.

- If the clip does not have an OK mark, an OK mark will be appended.
- If the clip is appended with an OK mark, the OK mark will be deleted.

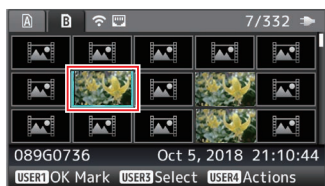

During Playback or Pause Screen

1 Press [USER1] button during clip playback.

- If the clip does not have an OK mark, an OK mark will be appended.
- If the clip is appended with an OK mark, the OK mark will be deleted.



Memo : _____

- The clip pauses when an OK mark is appended or deleted during playback.

Appending/Deleting OK Mark of Multiple Clips

To select and append/delete OK mark for multiple clips, refer to "[Selecting and Performing Operations on Multiple Clips] (P 104)".

Selecting and Performing Operations on Multiple Clips

- Multiple clips can be selected during thumbnail screen or playback screen display.
- After selecting multiple clips, perform appending/deleting of OK mark, deleting of clips using the action selection screen.
- After selecting multiple clips, the selections will be canceled by the following operations.
 - When [Deselect All] in the action menu is selected
 - When exiting Media mode from the thumbnail screen
 - When removing the SD card
 - When switching the slot in use

Selecting Multiple Clips Randomly

- 1 Move the cursor to a clip without a check mark, and press the [USER3] button. A green check mark appears on the clip.



- 2 Repeat Step 1 to select multiple clips.
 - Multiple clips can be selected.
 - Press the [USER4] button while the multiple clips are selected.
 - Appends OK mark together:
[Add OK Mark] → [Selected Clips]
 - Deletes OK mark together:
[Delete OK Mark] → [Selected Clips]
 - Uploading selected clips to the FTP server together:
[FTP Upload] → [Selected Clips]
 - Deletes selected clips together:
[Delete Clips] → [Selected Clips]

Memo : _____

- Selecting clips appended with check mark and pressing the [USER3] button will cancel the selection.
- If the operation is performed on multiple clips at the same time, a progress bar appears. You can stop the operation by pressing the Set button (●) while the operation is in progress. However, it is not possible to undo operations that are completed.

Selecting Multiple Clips Consecutively

- 1 Press the [USER4] button.
- 2 Select "Select Range" in the action selection screen, and press the Set button (●).

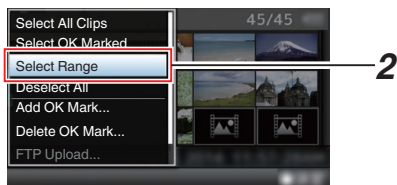

- 3 Move the cursor to the beginning (or end) of the range for multiple selection, and press the Set button (●).
- 4 Move the cursor to the other end of the range.
 - Magenta check marks appear on the clips within the range. (Including clips that were already selected.)
 - Gray check marks appear on selected clips that are outside the range.

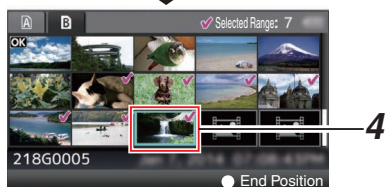
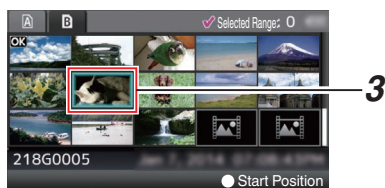

- 5 Press the Set button (●) to confirm the range.
 - The check marks change from magenta to green.
 - Pressing the [USER4] button while the multiple clips are selected displays the action selection screen. The following operations can be performed.
 - Appends OK mark together: [Add OK Mark] → [Selected Clips]
 - Deletes OK mark together: [Delete OK Mark] → [Selected Clips]
 - Uploading selected clips to the FTP server together: [FTP Upload] → [Selected Clips]
 - Deletes selected clips together: [Delete Clips] → [Selected Clips]

Memo :

- Selecting clips appended with check mark and pressing the [USER3] button will cancel the selection.
- If the operation is performed on multiple clips at the same time, a progress bar appears. You can stop the operation by pressing the Set button (●) while the operation is in progress. However, it is not possible to undo operations that are completed.

Trimming Recorded Clips

You can extract (trim) the necessary parts of a clip recorded in the SD card.

The trimmed clip is saved as a new file on the same SD card as the original clip. No changes are made to the original clip.

1 Switch to Media mode.

Switch the mode using the [CAM/MEDIA] selection button on the side control panel.

2 Move the cursor to the clip to be trimmed.

Move the cursor to the clip to be trimmed using the cross-shaped button (▲▼◀▶).

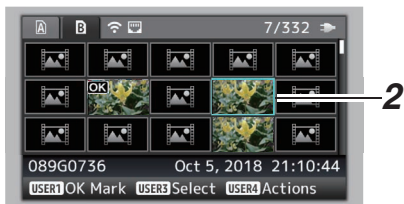

3 Press the [USER4] button.

The action selection screen is displayed.

4 Select [Trim This Clip], and press the Set button (●).

Playback of the selected clip starts.

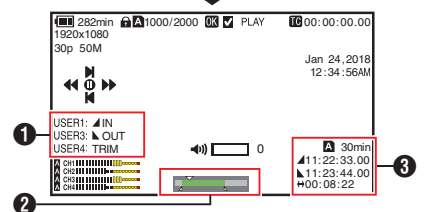
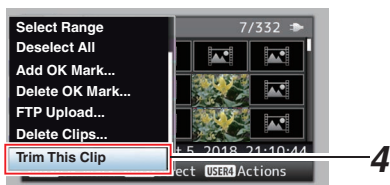

1 Guide

Operation guide

2 Position bar

- ▼ : Current position of the video
- ▲ : Position to start trimming (in point)
- ▶ : Position to end trimming (out point)

3 Trimming information

- A or B : Indicates the available space in the storage media (A or B)
- ▲ : Indicates the time code of the in point
- ▶ : Indicates the time code of the out point
- ↔ : Indicates the duration from the in point to the out point

Memo : _____

- The trimmed clip will be saved to the same card slot as that of the original clip.
- [Duration] appears in yellow if the duration is 10 minutes or longer. Trimming cannot be performed in this case.
- When [System] → [Record Set] → [Record Format] → [Frame Rate] is set to “4:2:2 F0 70M (XHQ)”, [Duration] appears in yellow if the duration is 6 minutes or longer. Trimming cannot be performed in this case.
- When [System] → [Record Set] → [Record Format] → [System] is configured to “HD EXT(SSD)”, [Duration] appears in yellow if it is 6 minutes or longer. Trimming cannot be performed in this case.
- [Duration] appears in yellow if the duration is longer than the recordable time on the storage media. Trimming cannot be performed in this case.
- When trimming starts, the display switches to the Media Display screen.

5 Specify the in point.

- Operate buttons such as ◀▶ or ▲▼ to move the video to the in point.
(P100 [Playing back])
- Specify the in point by pressing the [USER1] button at the point you want to start trimming.

6 Specify the out point.

- Operate buttons such as ◀▶ or ▲▼ to move the video to the out point.
(P100 [Playing back])
- Specify the out point by pressing the [USER3] button at the point you want to end trimming.

7 Perform trimming.

Press the [USER4] button to perform trimming.

Memo : _____

- While trimming is in progress, you can press the [CANCEL/RESET] button to return to the thumbnail screen.
- When trimming the in and out point, the in point trimmed may be up to one second before the specified in point and the out point trimmed may be up to one second behind the specified out point.

Basic Operations in Menu Screen

- Pressing the [MENU/THUMB] button displays the menu screen on the LCD monitor and viewfinder.
- Various settings for shooting and playback can be configured on the menu screen.
- There are two types of menu screens - [Main Menu] and [Favorites Menu].
- [Main Menu] contains all the setting items of the camera recorder, classified according to functions and uses, while [Favorites Menu] allows users to customize the menu items freely. (☞ P166 [Adding/Editing Frequently Used Menu Items (Favorites Menu)])
- The operating procedures and main screen displays are the same for both menus.
- The menu screen can also be displayed on external monitors connected to the video signal output terminal.
(☞ P134 [Character (SDI OUT2)])
(☞ P136 [Character (HDMI OUT)])
(☞ P137 [Character (VIDEO OUT)])
- The menu screen can also be displayed on the View Remote screen.

Operation Buttons

To operate the menu, use the cross-shaped buttons on the side operation panel of the camera recorder or the cross-shaped buttons at the front of the camera or at the bottom of the lens.

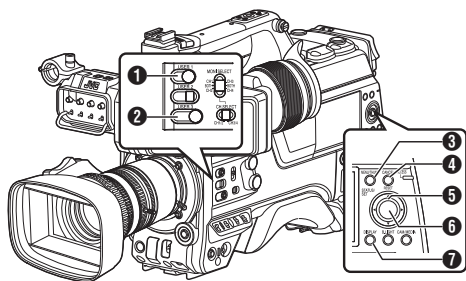

- 1 [USER1] Button
Adds the selected menu or submenu item to the [Favorites Menu].
- 2 [USER3] Button
Resets settings in the [TC Preset] or [UB Preset] setting screen.
- 3 [MENU/THUMB] Button
 - Displays the menu screen. The [Main Menu] screen is displayed by default.
 - During normal usage, [Main Menu] is displayed if the previous menu operation ended at [Main Menu], and [Favorites Menu] if the previous menu operation ended at [Favorites Menu].
 - Press this button to close the menu screen during menu display and return to the normal screen.
 - Pressing and holding down the button while the menu is displayed switches the [Main Menu] screen to the [Favorites Menu] or vice versa.
(☞ P166 [Adding/Editing Frequently Used Menu Items (Favorites Menu)])
- 4 [CANCEL/RESET] Button
Cancels settings and returns to the previous screen.
- 5 Cross-shaped Button (▲▼◀▶)
 - ▲ : Moves the cursor upward.
 - ▼ : Moves the cursor downward.
 - ◀ : Moves back to the previous item.
 - ▶ : Moves forward to the next item.
- 6 [STATUS/SET] Button (●)
Sets the values and items.
- 7 [DISPLAY] Button
Switches between the [Main Menu] and [Favorites Menu] screens.

Display and Description of the Menu Screen

Selecting Menu Items

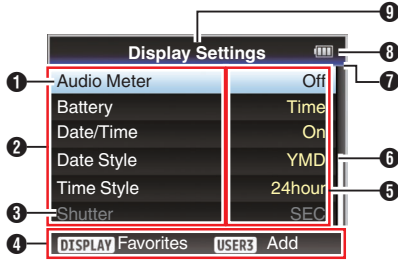

- 1 Cursor
Indicates the selected item. Use the cross-shaped button (▲▼) to move the cursor
- 2 Menu Item
 - Displays the names of the menu item and sub-menu.
 - Menu items with [...] after them indicates that there is a sub-menu to access.
- 3 Fixed Item
Items that cannot be changed are displayed in gray and cannot be selected.
- 4 Operation Guide
Guide for the current operation buttons.
- 5 Setting Value
Setting values for the menu items.
For menus with sub-menus, values are not displayed.
- 6 Scroll Bar
Indicates the scroll position.
- 7 Header
Indicates the current menu type with the line color.
 - Blue : [Main Menu] Screen
 - Green : [Favorites Menu] (Operation screen)
 - Magenta : [Favorites Menu] (Editing screen)
- 8 Remaining Battery Power
(P36 [Power Status Display])

Memo : _____

- The battery mark that indicates the battery level may not appear depending on the battery in use.

- 9 Menu Title
Title of the currently displayed menu.

Changing Setting Values

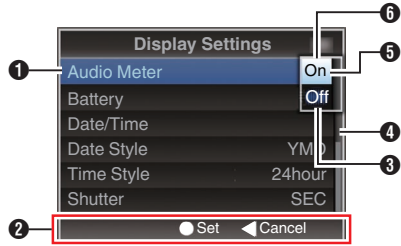

- 1 Menu Item to Change
Menu item to be changed.
A list of setting values 6 appears in a pop-up.
- 2 Operation Guide
Guide for the current operation buttons.
- 3 Setting Values Before Change
Setting values before changing. The background of the item is displayed in blue.
- 4 Scroll Bar
Indicates the scroll position.
- 5 Cursor
Indicates the selected item. Use the cross-shaped button (▲▼) to move the cursor
- 6 List of Setting Values
 - A pop-up displaying a list of setting values for selection.
 - The height of the pop-up depends on the number of settings available. Use the scroll bar 4 to confirm the current display status.

Text Input with Software Keyboard

Use the software keyboard to enter the [Setup File] subname, [Clip Name Prefix], and the settings under [Network].

Entering a subname

(☞ P185 [Configuring Setup Files])



Entering the [Clip Name Prefix]

(☞ P165 [Clip Name Prefix])

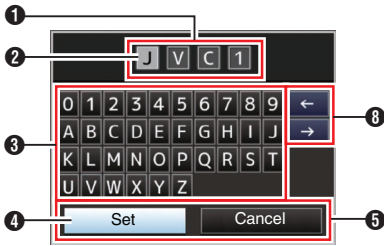

Settings under [Network]

The keyboard displayed varies according to the settings.

(☞ P143 [Network Menu])

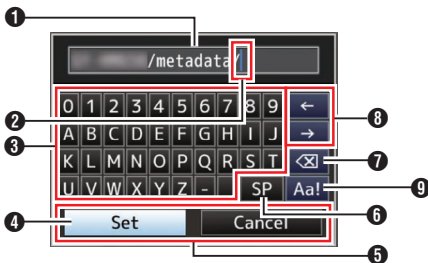

- 1 Character Entry Field
 - Field for entering the title.
 - You can enter up to 8 characters for the [Setup File] subname or up to 4 characters for the [Clip Name Prefix].
- 2 Character Cursor

Select a character using the key cursor 4, and press the Set button (●) to input the selected character at the position of the character cursor. The character cursor moves to the next position on the right each time a character is input. The cursor can be moved using the arrow keys 8.
- 3 Character Keys

Use the cross-shaped button (▲▼◀▶) to move the key cursor 4 to the character you want to enter.
- 4 Key Cursor

Indicates the currently selected character or item. Use the cross-shaped button (▲▼◀▶) to move the cursor.
- 5 Confirmation Buttons
 - Select [Set]/[Store] and press the Set button (●) to confirm the title.
 - Select [Cancel] and press the Set button (●) on the side control panel of the camera recorder to abort character input and return to the previous screen.
- 6 [SP] Space Key

Select [SP] and press the Set button (●) on the side control panel of the camera recorder to enter a space at the current position of the character cursor 2.
- 7 [X] Backspace Key

Select [X] and press the Set button (●) on the side control panel of the camera recorder to delete the character on the left of the character cursor 2.
- 8 Arrow Keys

Moves the position of the character cursor 2.
- 9 Character Switch Button

Switches the character buttons 3 to the upper case, lower case, and symbols.

Menu Screen Hierarchical Chart

[Main Menu...]	(P 110)	[LCD/VF...]	(P 128)
[Camera Function...]	(P 111)	[Shooting Assist...]	(P 128)
[Chroma Aberration]	(P 111)	[Marker Settings...]	(P 128)
[Pixel Mapping]	(P 111)	[Display Type...]	(P 128)
[Shutter]	(P 111)	[Display On/Off...]	(P 128)
[AE Level]	(P 111)	[VF Color]	(P 128)
[AE Speed]	(P 111)	[LCD Contrast]	(P 128)
[AE Area]	(P 111)	[LCD Bright]	(P 128)
[AGC Limit]	(P 112)	[LCD Peaking]	(P 128)
[Auto Iris Limit (OPEN)]	(P 112)	[Convert to ITU709]	(P 128)
[Auto Iris Limit (CLOSE)]	(P 112)	[LCD RGB Gain]	(P 129)
[EEL Limit]	(P 112)	[VF RGB Gain]	(P 129)
[Smooth Trans]	(P 112)	[AV Set...]	(P 134)
[FAW]	(P 112)	[Video Set...]	(P 134)
[FAW Speed]	(P 112)	[Audio Set...]	(P 138)
[GAIN L]	(P 112)	[Network]	(P 143)
[GAIN M]	(P 112)	[Connection Setup...]	(P 143)
[GAIN H]	(P 112)	[Live Streaming...]	(P 143)
[Lens REC]	(P 113)	[Return over IP...]	(P 143)
[User Switch Set...]	(P 113)	[Web...]	(P 143)
[Full Auto...]	(P 113)	[Metadata Server...]	(P 143)
[Camera Process...]	(P 118)	[Upload Settings]	(P 143)
[Color Space]	(P 118)	[Import Metadata]	(P 144)
[Gamma]	(P 118)	[Zero Config]	(P 144)
[Detail]	(P 119)	[Reset Network]	(P 144)
[Master Black]	(P 119)	[System...]	(P 157)
[Black Paint]	(P 119)	[Record Set...]	(P 157)
[Flare]	(P 119)	[Media]	(P 157)
[V. Shading]	(P 119)	[Setup File]	(P 157)
[Black Toe]	(P 120)	[Tally System]	(P 157)
[Knee Level]	(P 120)	[Front Tally]	(P 157)
[Auto Knee Sensitivity]	(P 120)	[Back Tally]	(P 157)
[Auto Knee Peak Filter]	(P 120)	[GPS] CHU CHE	(P 157)
[White Clip]	(P 121)	[Battery]	(P 158)
[Chroma Clip]	(P 121)	[Language]	(P 158)
[White Balance...]	(P 121)	[Reset All]	(P 158)
[Color Matrix]	(P 121)	[Date/Time]	(P 158)
[Color Gain]	(P 122)	[Date Style]	(P 159)
[Reverse Picture]	(P 122)	[Time Style]	(P 159)
[DNR]	(P 122)	[Time Zone]	(P 159)
[Reset Process]	(P 122)	[Reserved]	(P 159)
[TC/UB...]	(P 126)	[System Information]	(P 159)
[TC Mode]	(P 126)		
[TC Preset]	(P 126)		
[UB Mode]	(P 127)		
[Drop Frame]	(P 127)		

Memo :

- Some menus cannot be set depending on the operating mode or status of the camera recorder. These items are displayed in gray, and they cannot be selected.
- Setting value with the ● mark is the factory default.

Camera Function Menu

Menu screen for specifying operation settings during shooting.
This item can only be selected in the Camera mode.

Chroma Aberration

For configuring whether to apply ALAC (Auto Lens Aberration Compensation) to reduce chromatic aberration of magnification which appears as colored outlines.

- Auto:
Configures to ALAC automatically when an ALAC-compatible lens is used.
- Off:
Disables the ALAC function.

[Setting Values: ●Auto, Off]

Memo : _____

- This function does not support CAC lenses, which adopts a different method of compensation from ALAC lenses.
- This function does not correct axial chromatic aberration.
- When in the “Auto” mode, chromatic aberration correction is functioning if chromatic aberration correction on the status screen (camera) is configured to “On”.

Pixel Mapping

Detects white spots in the sensor and performs correction to reduce the defect. To perform pixel mapping, do so in the Camera mode after attaching the lens cap.

[Setting Values: Execute, ●Cancel]

Memo : _____

- It is recommended to use the AC adapter as the power supply.
- Selection for this item is disabled when [System] is configured to “High-Speed”.

Shutter

For specifying shutter-related settings.

When “Slow” or “Step/Variable” is selected, configure the shutter speed by pressing “SEL” of the [SHUTTER] switch and using the cross-shaped button (▲▼).

The cross-shaped button (◀▶) can also be used to switch between step and variable.

- Slow:
Configures the shutter speed to low speed.
- EEI:
Select this to perform automatic control of the shutter.
- Step/Variable:
Step mode switches the shutter speed in fixed values. Selecting Variable configures the setting to variable scan. Use this setting when shooting a PC monitor.

[Setting Values: Slow, EEI, ●Step/Variable]

Memo : _____

- When “J-Log1” or “HLG” is selected for [Camera Process] → [Color Space], “EEI” cannot be selected.

AE Level

For setting the convergence level during AE (Auto Exposure).

[Setting Values: -6 to +6 (●0)]

Memo : _____

- When “J-Log1” or “HLG” is selected for [Camera Process] → [Color Space], [AE Level] cannot be configured.
- AE level can also be configured using the cross-shaped button (▲▼) after operating the user button that is assigned with the AE Level function.

AE Speed

For setting the convergence speed during AE (Auto Exposure).

[Setting Values: ●Fast, Middle, Slow]

AE Area

For configuring the AE detection area.

[Setting Values: Center, Bottom, ●Normal]

AGC Limit

For setting the maximum gain value of “AGC”, which electrically boosts the sensitivity level according to the brightness automatically.

- When [LCD/VF] → [Display Type] → [Gain] is set to “dB”:
[Setting Values: 30 dB, 24 dB, ●18 dB, 12 dB, 6 dB]
- When [LCD/VF] → [Display Type] → [Gain] is set to “ISO”:
[Setting Values: ISO 25600, ISO 12800, ●ISO 6400, ISO 3200, ISO 1600]

Auto Iris Limit (OPEN)

For setting the limit value of the OPEN end when auto iris is enabled.

[Setting Values: F5.6, F4, F2.8, ●F2, Open]

Auto Iris Limit (CLOSE)

For setting the limit value of the CLOSE end when auto iris is enabled.

[Setting Values: F16, ●F11, F8, F5.6]

EEl Limit

For setting the shutter speed control range when the Automatic Shutter mode (EEI) is enabled.

[Setting Values: 4F-stop, ●3F-stop, 2F-stop]

Smooth Trans

For setting the shock reduction function, which slows down the sudden change when switching with the [GAIN] or [WHT.BAL] switch.

[Setting Values: On, ●Off]

Memo : _____

- This function is disabled when AGC is operating.

↳ Gain

For configuring the speed at which gain changes when [Smooth Trans] is set to “On”.

[Setting Values: Fast, ●, Middle, Slow, Off]

↳ Shutter

For configuring the speed at which the shutter changes when [Smooth Trans] is set to “On”.

[Setting Values: Fast, ●, Middle, Slow, Off]

↳ White Balance

For configuring the speed at which white balance changes when [Smooth Trans] is set to “On”.

[Setting Values: Fast, ●, Middle, Slow, Off]

FAW

For setting the position in the white balance switch [WHT.BAL] to assign the FAW (Full Auto White Balance) function.

[Setting Values: B, A, PRST, ●None]

FAW Speed

For configuring the operation speed of FAW (Full-time Auto White Balance)

[Setting Values: ●Fast, Middle, Slow]

GAIN L, GAIN M, GAIN H

For setting the gain value of each position on the [GAIN] selection switch.

The setting is fixed at “AGC” in the Full Auto mode. In addition, the sensitivity setting in [Lolux] is used.

(☞ P115 [Lolux])

- When [LCD/VF] → [Display Type] → [Gain] is set to “dB”:
[Setting Values: AGC, 30 dB, 27 dB, 24 dB, 21 dB, 18 dB, 15 dB, 12 dB, 9 dB, 6 dB, 3 dB, 0 dB, -3 dB, -6 dB]
(Default values for GAIN L: 0dB, GAIN M: 6dB, GAIN H: 12dB)
- When [LCD/VF] → [Display Type] → [Gain] is set to “ISO” and [Camera Process] → [Color Space] is set to a value other than “HLG”:
[Setting Values: AGC, ISO25600, ISO20000, ISO16000, ISO12800, ISO10000, ISO8000, ISO6400, ISO5000, ISO4000, ISO3200, ISO2500, ISO2000, ISO1600, ISO1250, ISO1000, ISO800, ISO640, ISO500, ISO400]
(Default values for GAIN L: ISO800, GAIN M: ISO1600, GAIN H: ISO3200)

Memo : _____

- “AGC” cannot be selected when “J-Log1” or “HLG” is selected for [Camera Process] → [Color Space].
- When “J-Log1” is selected for [Camera Process] → [Color Space], the base ISO speed for achieving the 800% dynamic range of [J-Log1] is “[ISO1000]”. The square brackets appear only in the case of the base ISO.

Lens REC

For selecting a function to be assigned to the Record button (VTR button, etc.) on the lens. A menu is displayed only when the FS-790 or FS-900 is connected.

- Intercom2:
Turns on/off the Intercom 2 connection.
- Intercom1:
Turns on/off the Intercom 1 (intercom) connection.
- Rec:
Starts/stops recording.

[Setting Values: Intercom2, Intercom1, ●Rec]

Memo : _____

- This function is available when it can be assigned to the Record button (VTR button, etc.) on the lens in use.
- Configure to “Intercom1” when configuring the intercom with the FS-790 connected.
- When the FS-900 or FS-790 is connected, the functions of “Intercom1” and “Intercom2” can also be assigned to a user button.

User Switch Set...

For specifying user button related settings.
(☞ P113 [User Switch Set Item])

Full Auto...

For configuring the Full Auto settings.
(☞ P117 [Full Auto Item])

Camera Angle[Tagging] **CHU** **STU**

For specifying tagging settings for the camera angle.

[Setting Values: SB, ●SL, EZ, SL2, EZ2, TV]

User Switch Set Item

USER0 to USER8, USER9▲, USER10▼, USER11◀, USER12▶, USER13● (front), USER1 (VF), USER2 (VF), LENS RET

The preconfigured function can be operated (on/off, start, switch) by assigning one of the functions in the following menu table to [USER0], [USER1], [USER2], [USER3], [USER4], [ONLINE/5], [USER6], [USER7], [USER8], [▲/9], [▼/10], [◀/11], [▶/12], front [SET/USER13] button, [RET] button on the lens and the [USER1(VF)] and [USER2(VF)] buttons on the viewfinder.

Set according to the shooting conditions. Usable in the Camera mode.

(☞ P45 [Assignment of Functions to User Buttons])

Memo : _____

- When a viewfinder is connected, priority is given to the [ZEBRA] switch of the viewfinder and the user button that is assigned with the “Zebra” function will not function.
- “Focus Assist +” is a combination of the “Focus Assist” and “Expanded Focus” functions.
- “Skin Detail +” is a combination of the “Skin Detail” and “Skin Area” functions.
- The [SET/USER13] button at the front functions as the [STATUS/SET] button in the factory setting, but it can also be assigned with the [USER13] function.
- If “VF Display” is assigned to the [USER1(VF)] or [USER2(VF)] button of the viewfinder, the button can also be used in the Media mode.
- The following functions can be assigned only for **CHU** **STU**.
[ODK Tagging]OFF, [ODK Tagging]DEF, [ODK Tagging]KO, [ODK Tagging]KOR, [ODK Tagging]P, [ODK Tagging]PR, [ODK Tagging]FG, [ODK Tagging]FGB, [ODK Tagging]REMOVE

The settable values for each item are as follows.

Setting Value	Button	[8]	[5]/[6]/[7]/ [LENS RET]	[0]/[1]/ [3]/[4]/ [9]/[10]/ [11]/[12]/ [13]	[2]	[USER1(VF)]/ [USER2(VF)]
VF Display		✓	✓	✓	X	✓
Cancel		✓	X	X	X	X
Status		✓	✓	✓	X	✓
Slot Select		✓	✓	✓	X	✓
Auto Upload		✓	✓	✓	X	X
Return over IP		✓	✓	✓	X	X
Live Streaming		✓	✓	✓	X	X
Load Picture File		✓	✓	✓	X	X
Return Video		✓	✓	✓	X	✓
Clip Review		✓	✓	✓	X	✓
OK Mark		✓	✓	✓	X	✓
Clip Cutter Trig		✓	✓	✓	X	✓
Backup Trig		✓	✓	✓	X	X
Rec		X	✓	X	X	X
LCD Backlight		✓	✓	✓	X	X
Spot Meter		✓	✓	✓	X	✓
Focus Assist		✓	✓	✓	✓	✓
Expanded Focus		✓	✓	✓	X	✓
Focus Assist +		✓	✓	✓	X	X
Marker		✓	✓	✓	✓	X
Zebra		✓	✓	✓	X	X
Video Signal Monitor		✓	✓	✓	X	✓
AWB		✓	✓	✓	X	✓
White Balance		✓	✓	✓	X	✓
Black Compress		✓	✓	✓	✓	X
Black Stretch		✓	✓	✓	✓	X
Skin Detail		✓	✓	✓	X	X
Skin Area		✓	✓	✓	X	X
Skin Detail +		✓	✓	✓	X	X
Zoom Wide		✓	✓	✓	X	X
Zoom Tele		✓	✓	✓	X	X
FULL AUTO		✓	✓	✓	✓	✓
AE Level		✓	✓	✓	X	X
AE Lock		✓	✓	✓	X	✓
Variable Gain		✓	✓	✓	X	X
Lolux		✓	✓	✓	✓	✓
None		✓	✓	✓	✓	✓

✓ : Settable

X : Not settable

Lolux

To increase the sensitivity when in dim surroundings, set a value in the Lolux mode.

- When [LCD/VF] → [Display Type] → [Gain] is set to “dB”:
[Setting Values: 42 dB, ●36 dB, 30 dB, 24 dB]
- When [LCD/VF] → [Display Type] → [Gain] is set to “ISO”:
[Setting Values: ISO 102400, ●ISO 51200, ISO 25600, ISO 12800]

Clip Review

For configuring the behavior when operating the user button that is assigned with the “Clip Review” function.

- Last 5sec:
Views about 5 seconds of the clip from the ending.
- Top 5sec:
Views about 5 seconds of the clip from the beginning.
- Clip:
Views the entire clip.

[Setting Values: ●Last 5sec, Top 5sec, Clip]

Spot Meter

For configuring the behavior when operating the user button that is assigned with the “Spot Meter” function.

- Max & Min:
Displays the brightest and darkest areas of the image.
- Max:
Displays the brightest area of the image.
- Min:
Displays the darkest area of the image.
- Manual:
Displays the image brightness at a specified position.

[Setting Values: ●Max & Min, Max, Min, Manual]

Memo : _____

- When “HLG” is selected in [Camera Process] → [Color Space], the value of the spot meter changes according to the setting of [LCD/VF] → [Convert to ITU709]/[White Level].

AE Lock

For configuring the behavior when operating the user button that is assigned with the “AE Lock” function.

- FAW:
Use this to fix the FAW (Full-time Auto White Balance) function to the value when the user button assigned with “AE Lock” is pressed.
- AE:
Use this to fix the Auto function of Gain, Iris, or Shutter to the value when the user button assigned with “AE Lock” is pressed.
- AE/FAW:
Use this to fix the FAW (Full-time Auto White Balance) function and the Auto function of Gain, Iris, or Shutter to the value when the user button assigned with “AE Lock” is pressed.

[Setting Values: FAW, ●AE, AE/FAW]

Memo : _____

- This feature only works when Iris, Shutter, Gain or White Balance is set to Auto mode.
- “AE Lock” is canceled when the user button assigned with “AE Lock” is pressed, or when any of the functions that can be locked is operated regardless of the mode (Manual or Auto).
- “AE Lock” is canceled when the lens extender is operated and when the iris is adjusted by 2/3 (two-third) stop or more.
- “AE Lock” is canceled in the following cases.
 - When the user button that is assigned with “AE Lock” is pressed
 - When changes are made to the iris (including operation of the lens extender), gain and shutter settings
 - When changes are made to the AE level
 - When there is a switch between the Camera and Media modes

Zoom Speed

For configuring the zoom speed when operating the user button that is assigned with “Zoom Tele” or “Zoom Wide”.

Increasing the value increases the speed.

[Setting Values: 8 to ●5 to 1]

Expanded Focus

For configuring the behavior when operating the user button that is assigned with the “Expanded Focus” function.

- **Limited Time:**
Activates the timer.
Turns off the “Expanded Focus” function about 3 seconds after the user button assigned with “Expanded Focus” is pressed.
- **Momentary:**
The “Expanded Focus” function is enabled during the interval while the user button assigned with “Expanded Focus” is pressed.
- **Toggle:**
Pressing the user button assigned with “Expanded Focus” each time switches the “Expanded Focus” function to on or off.

[Setting Values: Limited Time, Momentary,

●Toggle]

Memo : _____

- When “Toggle” is selected after assigning the expanded focus to any of the [▲/9], [▼/10], [◀/11], [▶/12] buttons, press the [CANCEL/RESET] button if you want to disable the function.

Video Signal Monitor

For configuring the behavior when operating the user button that is assigned with the “Video Signal Monitor” function.

- **Switch in Order:**
Pressing the button each time switches the mode in the following sequence: Vectorscope, Waveform, Histogram, Off.
- **On/Off:**
Switches the function configured in [LCD/VF] → [Shooting Assist] → [Video Signal Monitor] to on or off.

[Setting Values: ●Switch in Order, On/Off]

Return Video

For configuring the behavior when operating the user button that is assigned with the “Return Video” function.

- **Camera↔PiP:**
Pressing the user button assigned with the “Return Video” function each time toggles between the captured video and picture-in-picture return video.
- **Camera▷PiP:**
The picture-in-picture return video is displayed when the user button assigned with the “Return Video” function is pressed and held down, and the captured video is displayed when the button is released.
- **PiP▷Camera:**
The captured video is displayed when the user button assigned with the “Return Video” function is pressed and held down, and the picture-in-picture return video is displayed when the button is released.
- **PiP▷Return:**
The return video is displayed when the user button assigned with the “Return Video” function is pressed and held down, and the picture-in-picture return video is displayed when the button is released.
- **Camera▷Return:**
The return video is displayed when the user button assigned with the “Return Video” function is pressed and held down, and the captured video is displayed when the button is released.

[Setting Values: Camera↔PiP, Camera▷PiP, PiP▷Camera, PiP▷Return, ●Camera▷Return]

Full Auto Item

For configuring the operation of each item in the Full Auto mode.
Full Auto can be turned on/off using the user button assigned with the “Full Auto” function.

Gain

For specifying the Gain operation.

- AGC:
 - Sets the gain to Auto.
- SW Set:
 - Follows the setting of the [GAIN] switch.

[Setting Values: ●AGC, SW Set]

Iris Control

For specifying the Iris control operation.

- Auto:
 - Sets the iris to Auto.
- SW Set:
 - Follows the setting of the [IRIS A/M] switch on the lens.

[Setting Values: ●Auto, SW Set]

Memo : _____

- This item can be specified even if the lens used does not have iris function.

Shutter

For specifying the Shutter operation.

- EEI:
 - Sets the shutter to Auto.
- SW Set:
 - Follows the setting of the [SHUTTER] switch.

[Setting Values: ●EEI, SW Set]

White Balance

For specifying the White Balance operation.

- FAW:
 - Sets the white balance to Auto.
- SW Set:
 - Follows the setting of the [WHT BAL] switch.

[Setting Values: ●FAW, SW Set]

Audio

For configuring the audio operation.

- Auto:
 - Sets the audio sound to Auto.
- SW Set:
 - Follows the settings of the [AUDIO CH1/2/3/4]-[MANUAL/AUTO] switches.

[Setting Values: ●Auto, SW Set]

Camera Process Menu

Menu screen for adjusting the quality of camera images.

This item cannot be selected in the Media mode.

Color Space

For configuring the color space that is used inside the camera.

The gamma and color gamut change automatically according to the selected color space.

When [System] is configured to a setting other than "SD" and "SD(SDI In)"

- J-Log1:
Color space that supports 800% dynamic range and log gamma
- HLG:
Color space that supports the ITU2100 HLG HDR
- ITU2020:
Color space that supports the ITU2020 wide color gamut

[Setting Values: J-Log1, HLG, ITU2020, ●ITU709]
When [System] is set to "SD" or "SD(SDI In)"

- ITU709:
ITU709 color space
- ITU601 (EBU):
Color space that supports the EBU color gamut
- ITU601 (170M):
Color space that supports the SMPTE170M color gamut
- ITU709:
ITU709 color space

[Setting Values: ITU601 (EBU), ITU601 (170M), ●ITU709]

Memo : _____

- When [System] is set to "HD" and when "J-Log1" or "HLG" is selected, some menu items under [Camera Process] cannot be configured.
- The AE function does not function when "J-Log1" or "HLG" is selected. When the [AUTO IRIS] switch on the lens is set to "AUTO", the iris is fixed at "F4".

↳ Colorimetry

For configuring the standard for converting R, G, B signals to Y, Cb, Cr signals when [Color Space] is configured to "HLG" or "ITU2020".

- ITU2020:
Records and outputs ITU2020 RGB signals using the Y-Cb-Cr signal conversion coefficient.
- ITU709:
Records and outputs ITU709 RGB signals using the Y-Cb-Cr signal conversion coefficient.

[Setting Values: ●ITU2020, ITU709]

Memo : _____

- This item is available when [Color Space] is set to "HLG" or "ITU2020".
- This is fixed at "ITU709" when [Color Space] is set to "J-Log1" or "ITU709".
- This is fixed at "ITU601" when [System] is set to "SD".

Gamma

For adjusting the gamma curve that determines the gradation expression.

(P182 [Adjusting the Gamma])

- Cinema 2:
Sets to a gamma curve with soft expression giving priority to high luminance gradation.
- Cinema 1:
Sets to a gamma curve with similar gradation to the screen characteristics of movies.
- Standard:
Sets to a standard gamma curve.
- Off:
Does not perform adjustment.

[Setting Values: Cinema 2, Cinema 1, ●Standard, Off]

Memo : _____

- [Gamma] cannot be configured when [Color Space] is set to "HLG" or "J-Log1". "HLG Gamma" is used during "HLG" and "J-Log1 Gamma" is used during "J-Log1".

↳ Level

The amount of correction can be specified separately when [Gamma] is set to “Standard”, “Cinema 1” or “Cinema 2”.

When [Gamma] is set to “Standard”

[Setting Values: 0.35 to ● 0.45 to 0.55 (in steps of 0.01)]

- Increase the number:
Finer gradation at bright areas and coarser gradation at dark areas.
- Decrease the number:
Finer gradation at dark areas and coarser gradation at bright areas.

When [Gamma] is set to “Cinema 1” or “Cinema 2”

[Setting Values: +10 to ● 0 to -10]

- Increase the number:
Finer gradation at dark areas and coarser gradation at bright areas.
- Decrease the number:
Finer gradation at bright areas and coarser gradation at dark areas.

Memo : _____

- When [Gamma] is set to “Standard” with the value set at [0.45], the gamma adjusted conforms to ITU709 or ITU2020.
- If [Gamma] is set to “Cinema 2”, the maximum peak signal decreases from 109% as the number becomes smaller in the setting values from 0 to -10. When the level is at -10, the video input with a dynamic range of 600% will be kept within a 100% output.
- The level cannot be configured when [Gamma] is set to “Off” or [Color Space] is set to “HLG” or “J-Log1”.

Detail

For adjusting the contour (detail) enhancement level.

Increasing the value increases the sharpness of the contour.

[Setting Values: +20 to -20, Off] (Default Value: -6 for “J-Log1” and “HLG” of Color Space; 0 for all other settings)

Memo : _____

- The setting values of this item and [Adjust...] are stored separately when [Color Space] is set to “HLG” or “J-Log1”.

↳ Adjust...

For specifying the detailed settings of the contour (detail).

( P123 [Detail/Adjust Item])

Memo : _____

- This item cannot be selected when [Detail] is set to “Off”.

Master Black

For adjusting the pedestal level (master black) that serves as the reference black.

Increasing the value increases the pedestal.

[Setting Values: +50 to -50 (●0)]

Memo : _____

- This item cannot be configured when [Color Space] is set to “J-Log1”.
- The setting value of this item is stored separately when [Color Space] is set to “HLG”.

Black Paint

For adjusting the R (red) and B (blue) components of black.

[Setting Values: +50 to +1, ●0, -1 to -50]

Memo : _____

- This item cannot be configured when [Color Space] is set to “J-Log1” or “HLG”.

Flare

Performs flare correction.

[Setting Values: ●On, Off]

↳ Master Flare

Performs correction to prevent the entire image from turning white due to light that enters the lens. The image appears blacker with a larger value, and whiter with a smaller value.

[Setting Values: +20 to +1, (●0), -1 to -20]

Memo : _____

- This item cannot be configured when [Color Space] is set to “J-Log1” or “HLG”.

↳ Flare Balance

For adjusting the balance between R (red) and B (blue).

[Setting Values: +10 to +1, (●0), -1 to -10] (R/B)

V. Shading

For adjusting shading (color shift) in the vertical direction which occurs due to the lens characteristics.

- On:
For adjusting shading.
- Off:
Fixes shading adjustment. Manual adjustment is not allowed.

[Setting Values: On, ●Off]

↳ Adjust

Performs vertical shading adjustment when [V. Shading] is set to “On”.

[Setting Values: -128 to ● 0 to +127]

( P69 [Vertical Shading Adjustment])

Black Toe

Process the dark areas according to the balance of bright and dark areas in the image to adjust the overall balance of contrast.

For altering the gain of dark areas. Adjust this item according to the condition of the captured video signals.

- **Stretch:**

Increases the gain of dark areas in an image to stretch the signals of these areas only, thereby showing the contrast between bright and dark areas more clearly.

Specify the amount of stretch with [Stretch Level].

- **Normal:**

Normal condition.

- **Compress:**

Compresses the gain of dark areas to increase the contrast when the entire image appears bright and contrast is weak. Specify the compression amount with [Compress Level].

[Setting Values: Stretch, ●Normal, Compress]

Memo : _____

- This item cannot be configured when [Color Space] is set to “J-Log1” or “HLG”.
- When “Black Stretch” or “Black Compress” is assigned to the [USER2] switch, priority is given to the user button setting and configuration using the menu is disabled.

↳ Stretch Level

Stretch amount increases when a larger value is specified.

[Setting Values: 5 to 1 (● 3)]

Memo : _____

- This item is displayed only when [Black Toe] is set to “Stretch”. Otherwise, this item appears as “---” and cannot be selected.
- This item cannot be configured when [Color Space] is set to “J-Log1” or “HLG”.

↳ Compress Level

Compression amount increases when a larger value is specified.

[Setting Values: 5 to 1 (● 3)]

Memo : _____

- This item is displayed only when [Black Toe] is set to “Compress”. Otherwise, this item appears as “---” and cannot be selected.
- This item cannot be configured when [Color Space] is set to “J-Log1” or “HLG”.

Knee Level

For specifying the start point (knee point) for compressing the video signal to show the gradation of the highlighted portion. Set the [OUTPUT] switch to “AUTO KNEE OFF”.

[Setting Values: 109.0%, 107.5%, 105.0%, 102.5%, 100.0%, 97.5%, ● 95.0%, 92.5%, 90.0%, 87.5%, 85.0%, 82.5%, 80.0%, 77.5%, 75.0%, 72.5%, 70.0%]

Memo : _____

- This item cannot be configured when [Color Space] is set to “J-Log1” or “HLG” and when [Gamma] is set to “Cinema 2”.

Auto Knee Sensitivity

For configuring the response speed of the knee operation when the [OUTPUT] switch is set to “AUTO KNEE ON”. Set to “Slow” when shooting an object under a condition where there is drastic change in the light intensity.

[Setting Values: ●Fast, Middle, Slow]

Memo : _____

- This item cannot be configured when [Color Space] is set to “J-Log1” or “HLG” and when [Gamma] is set to “Cinema 2”.

Auto Knee Peak Filter

For configuring the response speed of the knee operation with respect to a high-luminance point light source and the like when the [OUTPUT] switch is set to “AUTO KNEE ON”.

[Setting Values: ●High, Middle, Low]

Memo : _____

- This item cannot be configured when [Color Space] is set to “J-Log1” or “HLG” and when [Gamma] is set to “Cinema 2”.

White Clip

For setting the point to apply white clip for video signals with a high luminance level.

[Setting Values: 109% to 90% (●109%)]

Memo : _____

- Set this item to 100% if the screen becomes too white with a setting value above 100% or when the system in use limits Y signals within 100%.
- The setting value of this item is stored separately when [Color Space] is set to "HLG" or "J-Log1".

↳ RGB Gamut Clip

For configuring whether to clip the RGB signals at the same time when clipping the luminance signal using the settings in [White Clip].

- On: Performs gamut clipping using the settings in [White Clip] for video signals with a high RGB signal level. Performs gamut clipping according to the settings in [White Clip] for negative signal levels.

[Setting Values: On, ●Off]

Memo : _____

- The area that is subject to gamut clipping when "On" is configured is as follows.

Example:

- [White Clip] 103 %
 - RGB signal: 103 % or above
 - Negative level: -3 % or below
- [White Clip] 100 % or below
 - RGB signal: Equivalent to or higher than the preset value in [White Clip]
 - Negative level: 0 % or below
- When RGB gamut clipping for EBU-R103 is supported, this feature can be configured to "On" and the value of [White Clip] can be adjusted to a desired level that is 104 % or lower.
- The setting value of this item is stored separately when [Color Space] is set to "HLG" or "J-Log1".

Chroma Clip

For configuring the point to apply chroma clipping for video signals with a high color difference level.

[Setting Values: 113% to 90% (●113%)]

Memo : _____

- When this is set to 100%, the Cb-Cr signal will be clipped so that it falls within the 64-960 range of the ITU 10-bit video standard.
- When [Color Space] is set to "HLG" or "J-Log1", the settings will be saved separately.

White Balance...

Menu for adjusting white balance.

(☞ P124 [White Balance Item])

- * For details, refer to "[Adjusting the White Balance]" (☞ P 65).

Color Matrix

For setting the color matrix.

- Natural:
 - Sets to a brighter and more natural color matrix than the standard. Effective for shooting under a strong single color light source such as stage lightings.
- Cinema Subdued:
 - Sets to a subdued color matrix that is similar to the screen characteristics of movies.
- Cinema Vivid:
 - Sets to a vivid color matrix that is similar to the screen characteristics of movies.
- Standard:
 - Sets to a standard color matrix.
- Off:
 - Sets the color matrix function to Off.

[Setting Values: Natural, Cinema Subdued, Cinema Vivid, ●Standard, Off]

Memo : _____

- This item cannot be configured when [Color Space] is set to "J-Log1".
- This is fixed at "Standard" when [Color Space] is set to "HLG".

↳ Adjust

This item is used to adjust [Color Matrix] to a color according to the user's preference.

The adjusted values of "Natural", "Standard", "Cinema Vivid", and "Cinema Subdued" in [Color Matrix] can be stored individually.

■ Linear Adjust:

The saturation, hue and brightness of the primary and complementary colors (6 colors in total) can be set individually when "On" is configured.

■ Multi Adjust:

The saturation and hue of the 16 hue axes (R/R+/Mg-/Mg/B-/B+/Cy-/Cy/Cy+/G-/G+/YI/YI+/R-) can be set when "On" is configured.

When the USER1 button is pressed while the multi adjustment screen is displayed, only the colors of the hue under adjustment remain in the following cases. The other colors become black and white.

- LCD monitor and viewfinder video images
- [HD/SD SDI OUT2] terminal output when [A/V Set] → [SDI OUT2] is set to "VF"
- [HDMI] terminal output when [A/V Set] → [HDMI OUT] is set to "VF"

( P183 [Adjusting Color Matrix])

Memo : _____

- This item cannot be configured when [Color Space] is set to "J-Log1".
- The setting value of this item is stored separately when [Color Space] is set to "HLG".

Color Gain

For adjusting the video signal color level.

Increasing the value deepens the color.

[Setting Values: +15 to -50, Off (●0)]

Memo : _____

- Images are displayed in black-and-white when this is set to "Off".
- This item cannot be configured when [Color Space] is set to "J-Log1".
- The setting value of this item is stored separately when [Color Space] is set to "HLG".

Reverse Picture

For recording images correctly by setting this item to "Rotate" when the lens image appears upside down or laterally inverted.

- Rotate: Enables horizontal/vertical inversion of the image.
- Off: Disables horizontal/vertical inversion of the image.

[Setting Values: Rotate, ●Off]

DNR

Decreases noise in the image.

[Setting Values: High, ●Middle, Low]

Reset Process

Restores all items in the [Camera Process] menu to their default settings.

Detail/Adjust Item

V/H Balance

For setting the H/V balance to enhance contour (detail) in the horizontal (H) or vertical (V) direction.

- H+1 to H+20:
Increasing the value enhances contour in the horizontal direction.
- V+1 to V+20:
Increasing the value enhances contour in the vertical direction.

[Setting Values: H+20 to H+1, ●Normal, V+1 to V+20]

H Frequency

For specifying the correction frequency of the horizontal contour. Set this according to the object.

- High:
Emphasizes the high frequency range. Use this when shooting objects with fine patterns.
- Middle:
Emphasizes the intermediate frequency range.
- Low:
Emphasizes the low frequency range. Use this when shooting objects with large patterns.

[Setting Values: High, ●Middle, Low]

V Frequency

For specifying the correction frequency of the vertical contour. Set this according to the object.

- High:
Emphasizes the high frequency range.
- Middle:
Emphasizes the intermediate frequency range.
- Low:
Emphasizes the low frequency range.

[Setting Values: High, ●Middle, Low]

Coring

For configuring the degree of enhancement with respect to low-level signals (noise, etc.) with subtle "outline" enhancement.

Applies outline enhancement to even low-level signals when the setting is closer to -20, and outline enhancement of low-level signals becomes less noticeable with noise suppressed when the setting is closer to +20.

[Setting Values: +20 to +1, ●0, -1 to -20]

Level Depend

Configure this item when areas such as the darker portions of the video image appear coarse when the Detail function is applied.

+1 reduces the outline enhancement of dark areas and suppresses the noise, while -1 enhances the outline of dark areas.

[Setting Values: +1, ●0, -1]

Posi Gain

For configuring the amount of detail in the white direction of the outline enhancement signals.

[Setting Values: +20 to +1, ●0, -1 to -20]

Nega Gain

For configuring the amount of detail in the black direction of the outline enhancement signals.

[Setting Values: +20 to +1, ●0, -1 to -20]

Knee Gain

For configuring the amount of detail at the highlight areas of the video image. A larger value further enhances the outline of the signals at the highlight areas. While a smaller value reduces the outline of the highlight areas, moire (aliasing) due to white clipping at the highlight areas is also less likely to occur.

[Setting Values: 32 to ●16 to 0]

Memo : _____

- This item cannot be configured when [Color Space] is set to "J-Log1" or "HLG".

Skin Detail

Detects the skin tone and smooths the outline.

[Setting Values: On, ●Off]

↳ Level

For configuring the outline correction level when [Skin Detail] is set to "On".

The smaller the number, the smoother the video.

[Setting Values: -1 to ●-5 to -10]

Skin Area

For configuring whether to display only the color correction area in color and areas that are not corrected in black-and-white.

- On:
 - When “Detect” of [Skin Color Adjust] is functioning, only the detected color is displayed in color and the other areas are displayed in black-and-white in the following cases.
 - LCD monitor and viewfinder video images
 - [HD/SD SDI OUT2] terminal output when [A/V Set] → [SDI OUT2] is set to “VF”
 - [HDMI] terminal output when [A/V Set] → [HDMI OUT] is set to “VF”
- Off:
 - Displays all the colors.

[Setting Values: On, ●Off]

Skin Color Adjust

For configuring details of the skin color.

- Detect
 - For detecting the skin tone.
 - [USER1]Stop appears when detection is in progress and [USER1]Execute appears while detection is stopped.
 - [Setting Values: Execute, Stop]
- Saturation
 - Selecting a larger value widens the saturation range of the color to be corrected, while a smaller value reduces the color saturation range.
 - [Setting Values: +10 to ●0 to -10]
- Width
 - Although selecting a larger value widens the hue range of the color to be corrected and eases identification, it also increases the likelihood of erroneous correction. Selecting a smaller value narrows down the hue range, but helps to reduce erroneous correction at the same time.
 - [Setting Values: +10 to ●0 to -10]

White Balance Item

Preset Temp.

For setting the color temperature when the [WHT.BAL] switch is set to “PRST”. For details, refer to “[Adjusting the White Balance] (P 65)”.

Alternative Temp.

For setting the alternative color temperature in the Preset mode. When the [WHT.BAL] switch is set to “PRST”, pressing the user button assigned with the “AWB” function each time switches the color temperature setting in the Preset mode. ([Preset Temp.] ↔ [Alternative Temp.]) For details, refer to “[Adjusting the White Balance] (P 65)”.

Preset Paint Memory

For configuring whether to configure the color temperature individually or collectively in the Preset mode. Adjustment is performed in [Preset Paint].

- Individual:
 - Each of the 9 types of color temperatures (2300K, 3000K, 3200K, 4200K, 4800K, 5200K, 5600K, 6500K, 7500K) are configured individually.
- Common:
 - The entire color temperature range is configured collectively.

[Setting Values: Individual, ●Common]

Preset Paint

For adjusting the R (red) and (B) blue components in the Preset mode.

- Increase the number:
 - Strengthens the red/blue.
- Decrease the number:
 - Weakens the red/blue.

[Setting Values: +32 to -32 (● 0)]

AWB Paint

For adjusting the R (red)/B (blue) component in the AWB (Auto White Balance) mode.

For details, refer to “[Adjusting the White Balance] (P 65)”.

- Increase the number:
Strengthens the red/blue.
- Decrease the number:
Weakens the red/blue.

[Setting Values: -32 to +32 (● 0)]

Memo : _____

- This item is selectable when the [WHT.BAL] switch is set to “A” or “B”. When “PRST” is set, this item appears as “---” and cannot be selected.
- Different values can be specified for “A” and “B”.
- When [Clear Paint After AWB] is set to “On”, pressing the user button that is assigned with the “AWB” function to readjust the white balance switches the R and B values automatically to “0”.

Clear Paint After AWB

For specifying whether to clear the [AWB Paint] (R value and B value) settings after executing AWB (Auto White Balance).

- On:
Sets the [AWB Paint] (R value and B value) settings to “0” after executing AWB (Auto White Balance).
- Off:
Does not change the [AWB Paint] (R value and B value) settings after executing AWB (Auto White Balance).

[Setting Values: ●On, Off]

FAW Paint

For adjusting the R (red)/B (blue) component during FAW (Full Auto White Balance) mode.

- Increase the number:
Strengthens the red/blue.
- Decrease the number:
Weakens the red/blue.

[Setting Values: -32 to +32 (● 0)]

TC/UB Menu

Menu screen for setting time code and user's bit. This item cannot be selected in the Media mode, or during recording.

TC Mode

For configuring the TC mode settings.

- **NTP:**
Activates NTP synchronization of the time code and superimposing of TC information (metadata) on the streaming data. This option is selectable when the [TC GEN] selection switch is set to F-RUN. When "NTP" is selected, the unit will operate in the F-RUN mode regardless of the position of the [TC GEN] selection switch.
- **GPS **CHU** **CHE**:**
Uses the GPS clock (UTC). The unit will operate in the F-RUN mode if GPS clock data cannot be acquired.
- **SW Set:**
Follows the settings of the [TC GEN] switch.
- **Clock:**
This is set to "Clock" when the [TC GEN] switch is set to "F-RUN".

[Setting Values: NTP, GPS, ●SW Set, Clock] **CHU** **CHE**

[Setting Values: NTP, ●SW Set, Clock] **STU** **RCHE**

Memo : _____

- When the [TC GEN] selection switch is set to "R-RUN" or "REGEN", or during "Interval Rec", "Frame Rec" and "High-Speed", the setting is fixed at "SW Set".
- [TC/UB] cannot be changed during live streaming when "NTP" is selected.

↳ Time Zone

For configuring the time zone.

- **Local Time:**
Time code with time zone corrected for time information obtained from NTP
- **UTC:**
Time code without time zone correction

[Setting Values: Local Time, ●UTC]

Memo : _____

- This item can be configured when [TC Mode] is set to "NTP".

↳ Streaming Format

For configuring the time code system.

[Setting Values: LTC, ●VITC]

Memo : _____

- This item can be configured when [TC Mode] is set to "NTP".
- This is fixed at "VITC" when [Live Streaming] → [Optional Adapter] is set to "Enable".

TC Preset

For setting the time code (hour, minute, second, frame).

Display : Drop setting 02:02:25.20

: Non Drop setting 02:02:25:20

(P76 [Setting Time Code Generator])

Memo : _____

- When the [TC GEN] switch is set to "REGEN", "<Regen>" is displayed and preset is disabled.
- When [TC Mode] is set to "Clock", "<Clock>" is displayed and preset is disabled.

UB Mode

For setting the recording mode of the user's bit.

- Date:
Records the date.
- Time:
Records the time.
- Preset:
Records according to the preset setting.
( P79 [Setting the User's Bit])

[Setting Values: Date, Time, ●Preset]

Memo : _____

- If [UB Mode] is set to "Time", the user's bit operates in the 24-hour format even if the LCD display is in the 12-hour format.

↳ Preset

For setting the user's bit. (Digit by digit)

Display : AB CD EF 01

( P79 [Presetting the User's Bit])

Memo : _____

- When [UB Mode] is set to "Date" or "Time", this item appears as "---" and preset is disabled.
- When the [TC GEN] switch is set to "REGEN", "<Regen>" is displayed and preset is disabled.

Drop Frame

For setting the framing mode of the time code generator.

- Non Drop:
Internal time code generator works in the non-drop-frame mode. Use this setting when placing emphasis on the number of frames.
- Drop:
Internal time code generator works in the drop-frame mode. Use this setting when placing emphasis on the recording time.

[Setting Values: Non Drop, ●Drop]

Memo : _____

- This item can be configured only when [System] → [Record Set] → [Record Format] → [A]Frame Rate] is set to "60p", "30p", or "60i". When [Frame Rate] is "24p", "Non Drop" becomes fixed and cannot be selected. When [Frame Rate] is "50p", "25p", or "50i", this item appears as "---" and cannot be selected.
( P161 [A]Frame Rate/ [EXT] Frame Rate))

LCD/VF Menu

Item for specifying settings related to the LCD monitor or viewfinder screen.

This menu screen can be used to specify settings related to the Focus Assist mode, zebra pattern display, screen size, marker, and safety zone. In addition, it is also used for selecting whether to display characters on the LCD monitor or viewfinder screen, as well as for adjusting the picture quality of the LCD monitor.

Shooting Assist...

Menu for setting the Shooting Assist function.

(P129 [Shooting Assist Item])

Marker Settings...

For setting items such as the safety zone and center mark.

(P131 [Marker Settings Item])

Display Type...

For specifying display-related settings.

(P132 [Display Type Item])

Display On/Off...

For configuring the on/off setting of the screen display.

(P133 [Display On/Off Item])

VF Color

For selecting whether to display the image on the viewfinder screen in color or black-and-white. Select "On" to display in color, and "Off" to display in black-and-white.

[Setting Values: ●On, Off]

LCD Contrast

For setting the difference in luminance between the darkest and brightness areas in the LCD monitor. Increasing the value increases the contrast.

[Setting Values: +10 to +1, ●0, -1 to -10]

LCD Bright

For configuring the brightness of the LCD monitor. Increasing the value increases the brightness.

[Setting Values: +10 to +1, ●0, -1 to -10]

LCD Peaking

For adjusting the outline of the image displayed on the LCD monitor.

[Setting Values: +10 to +1, ●0, -1 to -10]

Convert to ITU709

When [Color Space] is set to "ITU2020", "J-Log1" or "HLG", the video images on the LCD monitor and viewfinder are converted to the ITU709 color space for display.

- When [A/V Set] → [Video Set] → [SDI OUT2] is set to "VF", the [HD/SD SDI OUT2] terminal output is also converted.
- When [A/V Set] → [Video Set] → [HDMI OUT] is set to "VF", the [HDMI] terminal output is also converted.
- Cam + Return:
The camera and return videos are converted from the color space configured in [Color Space] to the ITU709 color space.
- Cam:
Only the camera video is converted to the ITU709 color space.
- Off:
Not converted.

[Setting Values: Cam + Return, Cam, ●Off]

Memo : _____

- This item can be configured only when [Color Space] is set to "ITU2020", "J-Log1" or "HLG".

↳ White Level

For configuring the white level during adjustment of the dynamic range that is visible in the LCD monitor or viewfinder when [Color Space] is set to "HLG". When [Color Space] is set to "HLG" and [Convert to ITU709] is set to a value other than "Off", this item can be used to configure the output luminance level (%) of HLG videos that corresponds to 100% on the ITU709 gamma curve during the conversion. [Setting Values: 80.0%, 77.5%, 75.0%, ● 72.5%, 70.0%, 67.5%, 65.0%, 62.5%, 60.0%, 57.5%, 55.0%, 52.5%, 50.0%]

Memo : _____

- This item can be configured only when [Color Space] is set to "HLG".
- The value on the spot meter changes in tandem with this setting.
Example: When [White Level] is set to "75.0%", the point at which the HLG output is 75% is displayed as 100% on the spot meter.
- Refer to [Tone Mapping Characteristics for Converting HLG to ITU709 for LCD/VF] (P 251) for each characteristic. Conversion to the ITU709 color space is performed with gamma and knee adjusted such that the maximum HDR dynamic range is visible during the conversion.

LCD RGB Gain

For adjusting the R (red), G (green) and B (blue) gain level of the LCD monitor.

[Setting Values: +127 to ● 0 to -128]

↳ Reset

Restores [LCD RGB Gain] to the default settings.

VF RGB Gain

For adjusting the R (red), G (green) and B (blue) gain level of the viewfinder.

[Setting Values: +127 to ● 0 to -128]

↳ Reset

Restores [VF RGB Gain] to the default settings.

[Shooting Assist Item

Focus Assist

For setting whether to add color to the contour of the focused image upon switching the image to black-and-white.

[Setting Values: On, ●Off]

↳ Type

For configuring the behavior when operating the user button that is assigned with the [Focus Assist] function.

(P59 [Focus Assist Function])

- ACCU-Focus:
Enables the Focus Assist and ACCU-Focus (forced focus) functions. The depth of field of the object becomes shallower to enable easier focusing. The ACCU-Focus function switches automatically to "Off" after about 10 seconds.
- Normal:
Enables only the Focus Assist function. The focused area is displayed in color to enable easier focusing. Display color can be specified with [Color].

[Setting Values: ACCU-Focus, ●Normal]

↳ Color

For setting the display color of the focused area when Focus Assist is activated.

[Setting Values: ●Blue, Green, Red]

Zebra

For selecting whether the number of zebra patterns to display at the bright areas of the subject.

(P82 [Setting Zebra Pattern])

- 2 Patterns:
Displays two types of zebra patterns (Zebra1 and Zebra2).
- 1 Pattern:
Displays one type of zebra pattern (Zebra1).

[Setting Values: 2 Patterns, ●1 Pattern]

↳ Detect

For configuring the timing to detect the zebra pattern display.

- Converted ITU709:
Performs detection after converting to the ITU709 color space.
- HLG/J-Log1:
Performs detection before converting to the ITU709 color space.

[Setting Values: Converted ITU709, ●HLG/J-Log1]

Memo : _____

- This item is selectable only when [Color Space] is set to "J-Log1" or "HLG" and [Convert to ITU709] is set to "Cam" or "Cam + Return".

↳ **Top 1**

For setting the maximum luminance level to display Zebra1.
 [Setting Values: Over, 100%, 98%, 95% to 5% (in 5% increments)] (●80%)

↳ **Bottom 1**

For setting the minimum luminance level to display Zebra1.
 [Setting Values: 100%, 98%, 95% to 0% (in 5% increments)] (●70%)

↳ **Top 2**

For setting the maximum luminance level to display Zebra2.
 [Setting Values: Over, 100%, 98%, 95% to 5% (in 5% increments)] (●Over)

Memo : _____
 • This item cannot be selected when [Zebra] is set to "1 Pattern".

↳ **Bottom 2**

For setting the minimum luminance level to display Zebra2.
 [Setting Values: 100%, 98%, 95% to 0% (in 5% increments)] (●80%)

Memo : _____
 • This item cannot be selected when [Zebra] is set to "1 Pattern".

Peaking Frequency

For configuring the frequency band for applying outline enhancement using [LCD Peaking] and the [PEAKING] adjustment knob on the viewfinder.
 [Setting Values: High, ●Middle, Low]

Video Signal Monitor

For configuring whether to display or hide the video signal monitor.
 [Setting Values: On, ●Off]

Memo : _____
 • This may not be selectable depending on the operating mode and status.

↳ **Type**

For configuring the video signal monitor to be displayed.

- **Histogram:**
 Displays the distribution of points in the image based on the degree of brightness and the corresponding number of points.
- **Vector Scope:**
 Displays the saturation and hue of the video as a circle.
- **Waveform:**
 Displays the luminance signal of the video as a waveform.

[Setting Values: Histogram, Vector Scope, ●Waveform]

↳ **Histogram Top**

For selecting the maximum brightness limit for changing the histogram display color.
 [Setting Values: 5% to 110% (in 5% increments)] (● 80%)

- When [Color Space] is set to "J-Log1"
 [Setting Values: -5F-stop, -4F-stop, -3F-stop(2%), -2F-stop, -1F-stop, 0F-stop(18%), 1/3F-stop, 2/3F-stop, 1F-stop, 1 1/3F-stop, 1 2/3F-stop, 2F-stop, 2 1/3 F-stop(90%), 2 2/3 F-stop, ●3F-stop, 3 1/3 F-stop, 3 2/3 F-stop, 4F-stop, 4 1/3 F-stop, 4 2/3 F-stop, 5F-stop, 5 1/3 F-stop, 5 2/3F-stop]

Memo : _____
 • When [Color Space] is set to "J-Log1", a green line appears which corresponds to the "0F-stop(18%)" portion of the subject with 18% reflectance.

↳ **Histogram Bottom**

For selecting the minimum brightness limit for changing the histogram display color.
 [Setting Values: 0% to 105% (in 5% increments)] (● 20%)

- When [Color Space] is set to "J-Log1"
 [Setting Values: -6F-stop, -5F-stop, -4F-stop, ●-3F-stop(2%), -2F-stop, -1F-stop, 0F-stop(18%), 1/3 F-stop, 2/3 F-stop, 1F-stop, 1 1/3 F-stop, 1 2/3 F-stop, 2F-stop, 2 1/3 F-stop(90%), 2 2/3 F-stop, 3F-stop, 3 1/3 F-stop, 3 2/3 F-stop, 4F-stop, 4 1/3 F-stop, 4 2/3 F-stop, 5F-stop, 5 1/3 F-stop]

Memo : _____
 • When [Color Space] is set to "J-Log1", a green line appears which corresponds to the "0F-stop(18%)" portion of the subject with 18% reflectance.

Marker Settings Item

For setting the marker and safety zone, which are useful in helping you determine the angle of view for the image according to the shooting purpose.

(P181 [Marker and Safety Zone Displays (Camera Mode Only)])

Memo : _____

- During Clip Review or when in the Media mode, the markers do not appear regardless of the setting.

Marker

For setting whether to display marker, safety zone, and center marks on the screen.

[Setting Values: On, ●Off]

↳ Grid Marker

For setting whether to display a 3x3 grid on the screen.

[Setting Values: On, ●Off]

Memo : _____

- When [Grid Marker] is set to “On”, [Aspect Ratio], [Aspect Marker], and [Safety Zone] do not function.

↳ Aspect Ratio

For selecting the final image aspect ratio to be used from the overall angle of view.

[Setting Values: 16:9(+4:3), 2.35:1 Top, 2.35:1 Center, 1.85:1 Top, 1.85:1 Center, ●16:9, 1.75:1, 1.66:1, 14:9, 13:9, 4:3]

Memo : _____

- When [System] → [Record Set] → [Record Format] → [SD Aspect] is set to “4:3”, this item is fixed at “4:3” and selection is disabled.

(P163 [SD Aspect])

↳ Aspect Marker

For specifying how boundary markers are to be used to indicate the parts of an image that are beyond the range of the aspect ratio selected in [Aspect Ratio].

- Line+Halftone:
Displays the boundary using lines, and areas outside the boundary in halftone.
- Halftone:
Displays areas outside the boundary in halftone.
- Line:
Displays the boundary using lines.
- Off:
Hides the boundary markers.

[Setting Values: Line+Halftone, Halftone, Line, ●Off]

Memo : _____

- When [Aspect Ratio] is set to “16:9” or “16:9(+4:3)”, this item is fixed at “Off” and cannot be selected.

↳ Safety Zone

For setting the percentage of area that is to be deemed as valid area (Safety Zone) within the boundary of the aspect ratio selected in [Aspect Ratio].

[Setting Values: 95%, 93%, 90%, 88%, 80%, ●Off]

↳ Center Mark

For specifying whether to display a mark to indicate the screen center within the aspect ratio selected in [Aspect Ratio].

[Setting Values: ●On, Off]

Display Type Item

This menu is used to set the displays on the LCD monitor and viewfinder screen.









Battery

For setting the display of the remaining battery power on the LCD monitor and viewfinder screen.

- Time:
Displays the remaining battery power in minutes. (min)
- Capacity%:
Displays the remaining battery power in percentage. (%)
- Voltage:
Displays the current battery voltage in units of 0.1 V. (V)

[Setting Values: ●Time, Capacity%, Voltage]

Memo : _____

- The battery mark that appears before the “Time”, “Capacity%” or “Voltage” value changes according to the remaining battery power.
 -  : Battery which the capacity could not be acquired
 -  : Below 13%
 -  : 13% or higher
 -  : 30% or higher
 -  : 60% or higher
 -  : Battery communication error
 -  : Calibration required
- While “Time” or “Capacity%” is displayed, “ RES” appears when the level falls below the setting in [System] ➔ [Battery] ➔ [Near End (%)]. Replace the battery as soon as possible.
- The remaining battery power and remaining time are intended as reference values for the shooting duration.
- When the battery that is connected does not support communication, the voltage is displayed regardless of the setting.

Zoom

For setting the display method of the zoom position.

- Number:
Displays the zoom position in numbers (Z00 to 99).
- Bar:
Displays the zoom position in a bar.

[Setting Values: Number, ●Bar]

Memo : _____

- This item will not be displayed if the lens attached does not support zoom position information.

Focus

For setting the display method of the approximate distance to the subject in focus during manual focus.

- Feet:
Displays the distance in feet.
- Meter:
Displays the distance in meters.

[Setting Values: Feet, ●Meter]

Memo : _____

- This item will not be displayed if the lens attached does not support focus position information.

Shutter

For setting the shutter display to be displayed on the LCD monitor and viewfinder screen.

- DEG:
Displays the shutter speed in degrees in the same way as film cameras.
- SEC:
Displays the shutter speed in seconds.

[Setting Values: DEG, ●SEC]

Memo : _____

- “DEG” is selectable only when [AFrame Rate] is set to “24p” or “25p”.
When [AFrame Rate] is set to other values, the shutter display setting is fixed at “SEC” and cannot be selected.
( P161 [AFrame Rate/ EXT Frame Rate])
- When a remote control unit is connected to the [REMOTE] terminal, “SEC” is displayed and selection is disabled.

Gain

For setting the gain display to be displayed on the LCD monitor and viewfinder screen.

- ISO:
Displays the gain as ISO sensitivity.
- dB:
Displays the gain in dB (decibel).

[Setting Values: ISO, ●dB]

Memo : _____

- This item cannot be configured when [Color Space] is set to "HLG".

Audio Meter

For specifying whether to display the audio level meter on the LCD monitor and viewfinder screen.

- Auto:
4ch display when [System] → [Record Set] → [Record Format] → [A]Audio is set to "4CH", and 2ch display ([CH1]/[CH2]) in all other cases. Whether 4 channels or 2 channels ([CH1]/[CH2]) are displayed during playback is dependent on the recorded clip.
- CH1/2:
Displays the audio level meter for [CH1] and [CH2].

[Setting Values: ●Auto, CH1/2]

Display On/Off Item

For setting whether to turn on or off the display of an item on the LCD monitor and viewfinder screen.

Battery, Clip Info, OK Mark, High-Speed, SDI IN, Check Mark, Media Status, Rec Trigger, TC/UB, Media Remain, Record Format, Video Format, Guide, GPS [CHU] [CHE], Return over IP, Live Streaming, Network, Date, Time, Operation Lock, Zoom, Focus, Zebra, Focus Assist, Color Space, Black Toe, Skin Detail, ND Filter, AE Level, Iris, Shutter, Gain, White Balance, Audio Meter, Position Bar, Camera Angle[Tagging][CHU] [STU], ODK[Tagging][CHU] [STU]

For configuring whether to display or hide an item.
[Setting Values: ●On, Off]

Memo : _____

- This may not be selectable depending on the operating mode and status.

A/V Set Menu

Menu screen for video output and audio.

Video Set...

For specifying video output-related settings.
(P134 [Video Set Item])

Audio Set...

For specifying audio-related settings.
(P138 [Audio Set Item])

Video Set Item

SDI OUT1

For configuring video output from the [HD/SD SDI OUT1] terminal.

[Setting Values: On, ●Off]

Memo : _____

- When a resolution with no SDI output is selected, the setting is fixed at "Off".
- This item needs to be configured to "On" even during SDI OUT1 output from the expansion unit terminal (68-pin) at the back.

↳ Resolution (SDI OUT1)

For selecting the resolution of video output from the [HD/SD SDI OUT1] terminal according to the monitor to be connected.

[Setting Values: 1080psF, 1080p, ●1080i, 720p, 576i, 480i]

Memo : _____

- The selectable options vary according to the setting in [System]/[A]Resolution and [A]Frame Rate of [System] → [Record Set] → [Record Format].
- Cross conversion output is not possible.
- When [A/V Set] → [Video Set] → [SDI OUT1] → [Resolution] is set to "1080p", configuring [System] → [GPS] to "On" changes the setting to "1080i". **CHU CHE**

SDI OUT2

For configuring video output from the [HD/SD SDI OUT2] terminal.

- VF:
Outputs the same display as that of the viewfinder.
- Camera:
Outputs from the terminal. The screen and menu displays can be configured in [SDI OUT2] → [Character].
- Return Video:
Outputs the return video in 1080p :
- Off:
Does not output from the terminal.

[Setting Values: VF, Camera, Return Video, ●Off]

Memo : _____

- When a resolution with no SDI output is selected, "Camera" cannot be selected.
- When [System] is set to "HD(SDI In)" or "SD(SDI In)", "Return Video" cannot be selected.
- When "Return Video" is selected
 - PinP display on the LCD is disabled.
 - Audio is not output.

↳ Character (SDI OUT2)

For configuring whether to show the display and menu on the [HD/SD SDI OUT2] terminal.

[Setting Values: On, ●Off]

Memo : _____

- When "VF" is selected for [SDI OUT2], the setting is fixed at "On".
- When "Return Video" is selected for [SDI OUT2], the setting is fixed at "Off".
- When [Overlay Settings] → [Overlay Function] is set to "Enable"
- The setting is fixed at "Off" when [Overlay Settings] → [Output] → [SDI OUT2] is configured to "Off"
- The setting is fixed at "Off" when [Overlay Settings] → [Output] → [SDI OUT2] is configured to "On" and [Resolution] configured to "480i"

↳ Resolution (SDI OUT2)

For selecting the resolution of video output from the [HD/SD SDI OUT2] terminal according to the monitor to be connected.

[Setting Values: 1080psF/i, 1080p, ●1080i, 720p, 576i, 480i]

Memo : _____

- The selectable options vary according to the setting in [System]/[A Resolution] and [A Frame Rate] of [System] → [Record Set] → [Record Format].
- Cross conversion output is not possible.
- When "Return Video" is selected for [SDI OUT2], signal is output from the [HD/SD SDI OUT 2] terminal at 1080p.

3G-SDI Mapping

For configuring the mode of mapping for signals output from the [HD/SD SDI OUT] terminal.

[Setting Values: Level B, ●Level A]

Memo : _____

- This item can be configured only when [SDI OUT1] → [Resolution] or [SDI OUT2] → [Resolution] is set to "1080p".
- When [SDI OUT1] or [SDI OUT2] is configured to "Off", this item cannot be configured.

SDI Rec Trigger

For configuring whether to superimpose trigger signals on the [HD/SD SDI OUT] terminal in tandem with the [REC] button.

If "Type-A" or "Type-B" is specified, it is possible to record on a device equipped with SDI record trigger in tandem with the operation of the [REC] button.

When a compatible device is connected, recording/stop control signals are output in tandem with the operation of the [REC] button.

The SDI record trigger output status to the connected device is indicated by REC →/STBY → on the display screen.

[Setting Values: Type-A, Type-B, ●Off]

Memo : _____

- If "Type-A" does not work, it may operate in the "Type-B" setting, but the user's bit to the connected device will not be correctly output.
- Even if REC →/STBY → is displayed on the display screen, the compatible device may not necessarily be recording.
- This item can be configured when [SDI OUT1] is set to "On" or [SDI OUT2] is set to a setting other than "Off", and [Rec Mode] is set to "Normal", "Pre Rec" or "Clip Continuous".
- Set to "Off" if connecting to a device that does not support record trigger.

HDMI OUT

For configuring video output from the [HDMI] terminal.

- VF:
Outputs the same display as that of the viewfinder.
- Camera:
Outputs from the terminal. The screen and menu displays can be configured in [HDMI OUT] → [Character].
- Return Video:
Outputs the return video in 1080p :
- Off:
Does not output from the terminal.

[Setting Values: VF, Camera, Return Video, ●Off]

Memo : _____

- When a resolution with no HDMI output is selected, "Camera" cannot be selected.
- When [System] is set to "HD(SDI In)" or "SD(SDI In)", "Return Video" cannot be selected.
- When "Return Video" is selected
 - PinP display on the LCD is disabled.
 - Audio is not output.

↳ Character (HDMI OUT)

For configuring whether to show the display and menu on the [HDMI] terminal.

[Setting Values: On, ●Off]

Memo : _____

- When "VF" is selected for [HDMI OUT], the setting is fixed at "On".

↳ Resolution (HDMI OUT)

For selecting the resolution of video output from the [HDMI] terminal according to the monitor to be connected.

[Setting Values: 1080psF/i, 1080p, ●1080i, 720p, 576p, 576i, 480p, 480i]

Memo : _____

- The selectable options vary according to the setting in [System]/[A Resolution] and [A Frame Rate] of [System] → [Record Set] → [Record Format].
- Cross conversion output is not possible.
- When "Return Video" is selected for [HDMI OUT], signal is output from the [HDMI] terminal at 1080p.

↳ Color

For setting the color format of HDMI signals.

[Setting Values: RGB, ●Auto]

Memo : _____

- This item can be configured when [HDMI OUT] is set to a setting other than "Off".

↳ Colorimetry

For configuring the colorimetry of the HDMI signal when [Camera Process] → [Color Space] → [Colorimetry] is set to "ITU2020".

- ITU2020:
Outputs using the colorimetry of ITU2020 regardless of the device that is connected via HDMI.
- ITU709:
Outputs using the colorimetry of ITU709 regardless of the device that is connected via HDMI.
- Auto:
Switches the colorimetry automatically according to the device that is connected via HDMI.

[Setting Values: ITU2020, ITU709, ●Auto]

Memo : _____

- This item can be configured when [HDMI OUT] is set to a setting other than "Off".
- This item can be configured when [HDMI Color] is set to "Auto".
- This item cannot be configured when [Camera Process] → [Color Space] → [Colorimetry] is set to a setting other than "ITU2020".

↳ Enhance

For setting the color range of HDMI signals. When connecting to a PC monitor, set this to "On".

[Setting Values: On, ●Off]

Memo : _____

- This item can be configured when [HDMI OUT] is set to a setting other than "Off".

↳ Rec Trigger

For configuring whether to superimpose trigger signals on the [HDMI] out terminal in tandem with the [REC] button.

If "On" is specified, it is possible to record on a device equipped with HDMI record trigger in tandem with the operation of the [REC] button. When a compatible device is connected, recording/stop control signals are output in tandem with the operation of the [REC] button. The HDMI record trigger output status to the connected device is indicated by REC →/STBY → on the display screen.

[Setting Values: On, ●Off]

Memo : _____

- Even if REC →/STBY → is displayed on the display screen, the compatible device may not necessarily be recording.
- This item can be configured when [HDMI OUT] is set to a value other than "Off", and [Rec Mode] is set to "Normal", "Pre Rec" or "Clip Continuous".
- Set to "Off" if connecting to a device that does not support record trigger.

↳ TC

For setting whether to superimpose time code to the [HDMI] terminal.

[Setting Values: On, ●Off]

Memo : _____

- This item can be configured when [HDMI OUT] is set to a setting other than "Off".
- Set to "Off" if connecting to a device that does not support HDMI TC.

VIDEO OUT

For configuring video output from the [VIDEO OUT] terminal.

[Setting Values: On, ●Off]

↳ Character (VIDEO OUT)

For configuring whether to show the display and menu on the [VIDEO OUT] terminal.

[Setting Values: On, ●Off]

SD Aspect

For setting the style of displaying images with a 16:9 aspect ratio on a 4:3 aspect ratio screen.

- Side Cut: Displays image with the left and right sides cut off.
- Letter: Displays as a wide image with the top and bottom blackened.
- Squeeze: Displays image that is squeezed horizontally.

[Setting Values: Side Cut, Letter, ●Squeeze]

Memo : _____

- When [Record Format] → [System] is set to "SD", and [Record Format] → [SD Aspect] is set to "4:3", "---" is displayed and selection is disabled.
(P160 [System])
- [System] → [Record Set] → [Record Format] → [System] is set to "SD", "Squeeze" and "Letter" can be selected.

SD Set Up

For selecting whether to add a setup signal to the video signal output from the [VIDEO OUT] terminal. Setup signals are added when "7.5%" is selected.

[Setting Values: 7.5%, ●0.0%]

Memo : _____

- Depending on the menu settings of the camera recorder and the condition of the cable connected to it, the setup signal setting may be fixed at "0.0%". "0.0%" is displayed in gray in this case.
- When [System] → [Record Set] → [Record Format] → [Frame Rate] is set to "50p" or "50i", "---" is displayed and selection is disabled.

Genlock Input

For selecting the input destination of video synchronizing signals.

- SDI IN:
Inputs video synchronizing signals from the [HD/SD SDI IN] terminal.
- Adapter:
Inputs video synchronizing signals from the adapter connected to the accessory connection terminal (68 pins) on the rear of the camera recorder.
- GENLOCK:
Inputs video synchronizing signals from the [GENLOCK] terminal.

[Setting Values: SDI IN, Adapter, ●GENLOCK]

Memo : _____

- When "HD(SDI In)" or "SD(SDI In)" is selected in [System], "SDI IN" is displayed and selection is disabled.

Genlock Adjust...

Adjusts the H Phase of the camera recorder's video signals with respect to the input synchronizing signals.

↳ SD-SDI H Phase

Adjusts the H Phase of the camera recorder's SD-SDI signal with respect to the external synchronizing signal input to the terminal set in the [Genlock Input] item.

[Setting Values: -373 to +373] (● 0)

Memo : _____

- When there is no SD video output from the [SDI OUT] terminal, "---" is displayed and selection is disabled.

↳ HD-SDI H Phase

Adjusts the H Phase of the camera recorder's HD-SDI signal with respect to the external synchronizing signal input to the terminal set in the [Genlock Input] item.

[Setting Values: -1024 to +1023] (● 0)

Memo : _____

- When there is no HD video output from the [SDI OUT] terminal, "---" is displayed and selection is disabled.

Return Input

For selecting the input destination of the return video.

- Network:
For inputting the return video from the preconfigured network.
- SDI:
Inputs return video from the [HD/SD SDI IN] terminal.

[Setting Values: Network, ●SDI]

Return Aspect

For selecting the aspect ratio of the return video.

- 16:9:
Select this option if the return video is a squeeze signal.
- 4:3:
Select this option if the return video is a 4:3 aspect signal (including Letter Box).

[Setting Values: ●16:9, 4:3]

Audio Set Item**Front Mic Select**

For selecting the microphone to be connected to the [MIC IN] terminal.

- Stereo M/S:
Selects the stereo M/S (Mid/Side) direct output microphone.
- Stereo L/R:
Selects the stereo L/R type microphone.
- Mono:
Selects the monophonic microphone.

[Setting Values: Stereo M/S, ●Stereo L/R, Mono]

Memo : _____

- When "Stereo M/S" is configured, use only stereo M/S (Mid/Side) direct output microphone.

Front Mic Power

Configure this setting when it is necessary to supply +48 V power to the microphone that is connected to the [MIC IN] terminal.

[Setting Values: ●On, Off]

Memo : _____

- When using a microphone that does not require a +48V power supply, make sure that it is set to the "Off" position before connecting the microphone.

Front Mic 1 Ref.

For setting the reference input level when the [AUDIO INPUT CH1] or [AUDIO INPUT CH3] selection switch is set to "FRONT".

[Setting Values: -30dB, -40dB, ● -50dB, -60dB]

Front Mic 2 Ref.

For setting the reference input level when the [AUDIO INPUT CH2] or [AUDIO INPUT CH4] selection switch is set to "FRONT".

[Setting Values: -30dB, -40dB, ● -50dB, -60dB]

Rear Mic 1 Ref.

For configuring the reference input level when the [AUDIO INPUT CH1] or [AUDIO INPUT CH3] selection switch is set to "REAR", and the [AUDIO INPUT1] selection switch to "MIC" or "MIC+48V".

[Setting Values: -30dB, -40dB, -50dB, ● -60dB]

Rear Mic 2 Ref.

For configuring the reference input level when the [AUDIO INPUT CH2] or [AUDIO INPUT CH4] selection switch is set to "REAR", and the [AUDIO INPUT2] selection switch to "MIC" or "MIC+48V".

[Setting Values: -30dB, -40dB, -50dB, ● -60dB]

Rear Line Ref.

For configuring the reference input level when one of the [AUDIO INPUT CH1/CH2/CH3/CH4] selection switches is set to "REAR", and the corresponding [AUDIO INPUT1/2] selection switch is set to "LINE".

[Setting Values: ●+4dB, 0dB, -3dB]

CH1 Audio Level/CH2 Audio Level/CH3 Audio Level/CH4 Audio Level**↳ Front, Rear/Wireless**

For configuring the method for adjusting volume level when the [MANUAL/AUTO] selection switch of [AUDIO INPUT CH1 (/2/3/4)] is set to "MANUAL".

- Front + CH1 (/2/3/4):
Adjust using the [MIC LEVEL] knob on the front and the [AUDIO INPUT CH1 (/2/3/4)] recording level adjustment knob.

- CH1 (/2/3/4) Knob:
Adjust using the [AUDIO INPUT CH1 (/2/3/4)] recording level adjustment knob.

- Front Knob:
Adjust using the [MIC LEVEL] knob on the front.

[Setting Values: Front + CH1 (/2/3/4), CH1 (/2/3/4) Knob, Front Knob]

(Default setting: "Front Knob" for Front, "CH1 (/2/3/4) Knob" for Rear/Wireless)

CH1/2 Audio Ref. Lv.

For setting the reference recording level of [CH1] and [CH2].

(Applies to both [CH1] and [CH2].)

[Setting Values: -12dB, -18dB, ●-20dB]

CH3/4 Audio Ref. Lv.

For setting the reference recording level of [CH3] and [CH4].

(Applies to both [CH3] and [CH4].)

- Ch1/2 -6 dB:
Sets to a value that is 6dB lower than that of [CH1] and [CH2].

- Ch1/2 -12 dB:
Sets to a value that is 12dB lower than that of [CH1] and [CH2].

- Ch1/2 Linked:
Sets to the same value as [CH1] and [CH2].

[Setting Values: Ch1/2 -6 dB, Ch1/2 -12 dB,

●Ch1/2 Linked]

CH1/2 DRC..., CH3/4 DRC...

For configuring the individual parameters of DRC (Dynamic Range Compression).

( P74 [References on DRC (Dynamic Range Compressor) and Limiter])

↳ Threshold Level

For configuring the threshold of DRC for CH1/2 and CH3/4.

[Setting Values: ● -6dBFS, -9dBFS, -12dBFS, -15dBFS, -17dBFS, Off]

↳ Attack Time

For configuring the time before DRC for CH1/2 and CH3/4 operates.

[Setting Values: Fast, ●Middle, Slow]

↳ Decay Time

For configuring the time before the DRC operation for CH1/2 and CH3/4 is canceled.

[Setting Values: Fast, ●Middle, Slow]

↳ Mode

For configuring whether DRC for each channel operates independently or in tandem with each other.

([CH1] and [CH2], [CH3] and [CH4])
Select "Linked" to link or "Separate" to separate.
[Setting Values: Linked, ●Separate]

Limitter...**↳ CH1 (/2/3/4)**

For configuring whether to enable limiter operation for each channel.

- On:
Enables limiter operation.
- Off:
Disables limiter operation.
- AUTO/MANUAL SW Set:
Operates according to the [AUDIO INPUT MANUAL/AUTO] selection switch.
Operation is "On" in the AUTO mode and "Off" in the MANUAL mode.

[Setting Values: On, Off, ●AUTO/MANUAL SW Set]

Mic Wind Cut...**↳ CH1 (/2/3/4)**

For configuring whether to cut the low-frequency range of the audio signal when "FRONT" or "REAR" is selected for [AUDIO INPUT] of each channel and "MIC" or "MIC+48V" is selected for [AUDIO INPUT 1/2] at the back of the camera.

Set this item to reduce wind noise from the microphone.

[Setting Values: On, ●Off]

Memo : _____

- When [Mic Wind Cut] is set to "On", a  icon is displayed on the status screen (audio input) while the function is operating.

Test Tone

For specifying whether to output the audio test signals (1 kHz) during color bar output.

[Setting Values: On, ●Off]

AUDIO OUT Ch.

For setting the channel to output to the [AUDIO OUT] terminal.

- CH3/4:
Outputs the audio of [CH3] and [CH4].
- CH1/2:
Outputs the audio of [CH1] and [CH2].
- MONI SEL SW Set:
Outputs according to the [MONI SELECT] switch setting.

[Setting Values: CH3/4, CH1/2, ●MONI SEL SW Set]

AUDIO OUT Ref.

For configuring the reference output level of the [AUDIO OUT] terminal.

[Setting Values: +4dB, ●0dB, -3dB]

AUDIO OUT Limiter

For configuring whether to enable limiter operation for the output of the [AUDIO OUT] terminal.

- On:
Enables limiter operation.
- Off:
Disables limiter operation.

[Setting Values: On, ●Off]

Memo : _____

- When [AUDIO OUT Limiter] is set to "On", a  icon is displayed on the status screen (audio output).

PHONE Output

For selecting whether to output audio from the [PHONE] terminal as stereo sound or mixed sound when the [MONI SELECT] switch is set to "BOTH".

- Stereo:
Outputs stereo sound (outputs audio sound of CH1(CH3) to L, and CH2(CH4) to R).
- Mix:
Outputs mixed sound (mixed sound of CH1(CH3) and CH2(CH4)) to both L and R.

[Setting Values: Stereo, ●Mix]

Min. ALARM Level

For configuring whether to output or mute the alarm sound when the [ALARM] volume adjustment knob is turned to the minimum level.

[Setting Values: Audible, ●Off]

Speaker Gain

For configuring the speaker gain.

[Setting Values: +6dB, +3dB, ●0dB, -3dB, -6dB]

Wireless Channel

For configuring the wireless channels.

- Dual:
Inputs the wireless Ch1 output to Ch1(CH3) Audio In and the wireless Ch2 output to Ch2(CH4) Audio In.
- Single:
Inputs the wireless Ch1 output to both of Ch1(CH3)/Ch2(CH4) Audio In.

[Setting Values: Dual, ●Single]

IFB/RET Monitor...**↳ CH1(/2)**

For configuring the output from the [PHONE] terminal during IFB Return over IP of each channel.

- Auto:
Outputs upon mixing the IFB/Return over IP audio with the microphone audio when IFB/Return over IP audio input is detected. Outputs only the microphone audio when IFB/Return over IP audio input is not detected.
- IFB/RET Only:
Outputs only the IFB/Return over IP audio at all times.
- Off:
IFB/Return over IP audio is not output.

[Setting Values: Auto, IFB/RET Only, ●Off]

Memo : _____

- To enable different settings for CH1 and CH2 of [IFB/RET Monitor], configure [PHONE] output to "Stereo".

↳ IFB/RET Audio ALC

For configuring the audio ALC operation during IFB/Return over IP.

[Setting Values: ●On, Off]

Memo : _____

- [IFB/RET Audio ALC] is an automatic level adjustment function that enables clear IFB/Return over IP audio.

↳ ALC Level

For setting the IFB/Return over IP audio level during ALC operation.

- High:
Automatically adjusts the IFB/Return over IP audio to maximum sound level.
- Middle:
Automatically adjusts the IFB/Return over IP audio to middle sound level.
- Low:
Automatically adjusts the IFB/Return over IP audio to low sound level.

[Setting Values: High, ●Middle, Low]

Memo : _____

- If the IFB/Return over IP audio is too loud, set this item to “Low”. If the sound is still loud even after setting to “Low”, set [IFB/RET Audio ALC] to “Off”.

Caution : _____

The IFB/Return over IP audio may not be audible if all the following conditions are true, please readjust each setting accordingly.

- [IFB/RET Audio ALC] is set to “Off”
- [IFB/RET Monitor]/[CH1][CH2] is set to “Auto”
- The audio input of IFB/Return over IP is low

VF Audio Output

For configuring the SDI audio output from the [VF] terminal.

[Setting Values: IFB/RET, Camera, ●Off]

Memo : _____

- This audio output setting is also applied when [SDI OUT2] or [HDMI OUT] is configured to “VF”.
- When “IFB/RET” is selected, the only options available for the audio output are IFB and Return over IP. SDI return audio is not output.

Network Menu

For specifying network-related settings.
The display of the software keyboard for input varies according to the item you are setting.

Connection Setup...

For configuring the network connection settings. A [Wizard] screen will appear according to the mode of connection. Follow the instructions to perform the setting.
The preconfigured settings can be loaded, saved or deleted.

(☞ P144 [Connection Setup Item])

Memo : _____

- Configure the [LAN] terminal and the USB terminal/built-in wireless LAN **CHU CHE** or USB terminal **STU RCHE** such that each has a different network address (network segment).
- Users cannot access this menu in the following cases.
 - During manual FTP transfer
 - During live streaming
 - Return over IP in Progress

Live Streaming...

For configuring settings for distributing live video images and audio.

(☞ P145 [Live Streaming Item])

Memo : _____

- Users cannot access this menu in the following cases.
 - When [Record Format] → [System] is set to "HD+Web" or "High-Speed"
 - During FTP transfer
 - When [Record Format] → [Frame Rate] is set to "24p"

Return over IP...

For configuring settings related to Return over IP. This function allows video and audio to be received via the network.

(☞ P149 [Return over IP Item])

Memo : _____

- Users cannot access this menu in the following cases.
 - Recording
 - When [System] is set to a setting other than "HD" or "SD"
 - When [Frame Rate] is set to "24p"
 - When [Overlay Settings] → [Overlay Function] is set to "Enable"
 - When [Slot Mode] is set to "Backup **EXT**"
 - When [Optional Adapter] is set to "Enable"

Web...

For setting the functions that make use of the web browser.

(☞ P152 [Web Item])

Metadata Server

For registering the FTP server for importing the metadata and the path of the file to be imported. Up to 4 settings can be registered.

(☞ P152 [Metadata Server Item])

Upload Settings

For configuring the method for uploading to the FTP server as well as the server and directory for uploading the clip recorded in the media to the FTP server.

(☞ P153 [Upload Item])

Import Metadata

- For importing metadata from the FTP server.
- Metadata loaded by the setup files (“User File”/ “All File”) will be deleted.
(☞ P198 [Importing Metadata])

Memo : _____

- This option is not selectable if the network connection is not established.
- This option is not selectable while using the network.

NTP

The time of the videos recorded simultaneously on multiple cameras can be synchronized by reflecting the time information retrieved from the NTP server in the time code.

The synchronization status with the NTP server can be checked in the Status screen (network).

Memo : _____

- If the network connection is incomplete, a different result may occur.
- An error of about several frames may occur in the time code information that reflects the NTP time.
- It may take a while to update the synchronization with the NTP server. To update immediately, turn off the power first, then turn it on again.

↳ Server Address

For setting the address of the NTP server.

If this is not configured, “Master Mode” appears on the Status screen (network).

However, “Not Synchronized” is displayed if the unit is not connected to a network when the power is turned on.

Zero Config

For allowing this camera recorder to be detected automatically by external devices (such as switchers) connected to the same LAN. Connection can be established via one link from the menu of the external device.

Memo : _____

- The Zero Config function is not equipped with the function to change the settings of the camera recorder.

↳ Announcement

For configuring the method of connection from an external device during automatic detection of this camera recorder.

[Setting Values: ●All, LAN, USB/Int. WLAN, Off]

CHU CHE

[Setting Values: ●All, LAN, USB, Off] **STU RCHE**
Only for cellular adapter connection (USB)

[Setting Values: ●LAN, Off]

↳ Hostname Prefix

Part of the host name can be changed.

It will appear in the format of “XXXX-YYYY.local” on the Status screen (network).

XXXX : Character string (maximum 8 characters) configured in [Hostname Prefix]

YYYY : Serial number of this camera recorder

Memo : _____

- When [Announcement] is set to “Off”, this item does not appear on the Status screen (LAN, USB/Int. WLAN **CHU CHE**, USB **STU RCHE**).

Reset Network

Restores all items in the [Network] menu to their default settings.

Connection Setup Item

Wizard

Displays a [Wizard] screen for connecting to the network.

Follow the instructions on the screen.

USB/Int. WLAN **CHU CHE**

For configuring the USB/built-in wireless LAN network connection to On/Off.

[Setting Values: On, ●Off]

Setup File **CHU** **CHE** / **USB Setup File** **STU** **RCHE****↳ Load**

Loads the settings on the [Wizard] screen.
(P218 [Reading the Connection Settings File])

↳ Store

Saves the settings on the [Wizard] screen.
(P217 [Saving the Connection Settings File])

↳ Delete

Deletes the saved settings.
(P219 [Deleting Connection Settings])

Default Gateway

For configuring the gateway to be used. Select the terminal that is connected to the router for external network access.

[Setting Values: ●LAN, USB/Int. WLAN] **CHU** **CHE**

[Setting Values: ●LAN, USB] **STU** **RCHE**

FTP Proxy...

For setting the FTP proxy.

↳ Type

Select the type of FTP proxy.
[Setting Values: ●No Proxy, HTTP]

↳ Server

Set the FTP proxy server name.

Memo : _____

- Enter the name using the onscreen keyboard.
- You can enter characters not more than 127 bytes using single-byte alphanumeric characters (a to z, 0 to 9), single-byte hyphen ("-") or dot (".").
- When [Type] is set to "No Proxy", changes cannot be made.

↳ Port

Set the FTP proxy port number.

Memo : _____

- Enter the name using the onscreen keyboard.
- Enter an integer between 1 and 65535.

APN

For specifying APN (Access Point Name).

- * This item is grayed out and cannot be selected if APN cannot be set for the adapter attached.

Caution : _____

- The APN setting is written into the cellular adapter, not this camera recorder. Setting a wrong APN may result in communication failure or expensive bills from the telecommunications company. Set the APN correctly.

Live Streaming Item**Live Streaming**

Starts live distribution when "On" is selected.
[Setting Values: On, ●Off]

Memo : _____

- "On" cannot be selected if streaming is not possible with the selected resolution, frame rate and bitrate combination.
- "On" cannot be selected if connection of the selected network in [Interface] is not established.
- "On" cannot be selected when FTP is running.
- Live streaming switches to "Off" when the power is turned off.

↳ Auto Restart

When the network is reconnected after disconnection, live streaming will resume automatically.

- On:
Once the network is reconnected, live streaming resumes automatically.
- Off:
Live streaming does not resume automatically even when the network is reconnected.

[Setting Values: On, ●Off]

Memo : _____

- When the power of the camera is turned off, regardless of the settings in [Auto Restart], live streaming does not begin automatically even when power is turned on again and network connection is established.
- The setting cannot be changed during live streaming (when live streaming is configured to "On").

Optional Adapter

H.265/HEVC streaming is possible with the use of KA-EN200 (sold separately).

Configure to “Enable”, followed by configuring the streaming server after rebooting.

[Setting Values: Enable, ●Disable]

Interface

For selecting the terminal for live streaming.

[Setting Values: ●LAN, USB/Int. WLAN] **CHU** **CHE**

[Setting Values: ●LAN, USB] **STU** **RCHE**

Server

For selecting the server for live streaming.

[Setting Values: ●Server1, Server2, Server3, Server4]

Memo : _____

- The setting cannot be changed during live streaming (when [Live Streaming] set to “On”).

↳ Streaming Server

For setting the server for live streaming.

Memo : _____

- The setting cannot be changed during live streaming (when [Live Streaming] set to “On”).

↳ Server1, Server2, Server3, Server4

* The name that is set in [Alias] is displayed individually.

■ Alias

For setting a name to distinguish the settings of this camera.

The name set in this item will be displayed in the [Server] options.

- *1 The default value is “Server1/Server2/Server3/Server4”.
- *2 You can enter up to 31 characters and ASCII characters.

■ Type

For configuring the system for transferring video and audio to be distributed.

[Setting Values: ●MPEG2-TS/UDP, MPEG2-TS/TCP, MPEG2-TS/RTP, RTSP/RTP, ZIXI(SRT), RTMP, RTMPS]

Memo : _____

- Use reception devices that are compatible with the respective transfer systems.
- To use the “ZIXI” setting, a dedicated server is needed separately.
- SRT protocol update needs to be performed before using the SRT protocol. Doing so will make the Zixi protocol unusable.
To enable the use of the Zixi protocol again, perform Zixi protocol update.
- The following items that can be set vary depending on the setting of this item.

■ Connection Mode

For configuring the SRT connection mode.

[Setting Values: ●Caller, Listener, Rendezvous]

Memo : _____

- This item is selectable only when [Type] is set to “SRT”.

■ Destination Address

For setting details such as the host name and the IP address of the live distribution destination.

* Enter not more than 127 characters using single-byte alphanumeric characters (a to z, 0 to 9), single-byte hyphen [-], or dot [.]

■ Destination URL

For entering the URL of the live distribution destination beginning with “rtmp://” or “rtmps://”. There is no default value (blank).

* You can enter up to 191 characters and ASCII characters.

Memo : _____

- Available when [Type] is set to “RTMP” or “RTMPS”.

■ Destination Port

Enter the network port number of the live distribution destination using an integer between 1 and 65535.

When [Type] is set to "MPEG2-TS/UDP", "MPEG2-TS/TCP" or "MPEG2-TS/RTP", the default value is "6504". If "ZIXI" is set, the default value is "2088".

Memo : _____

- When [Type] is set to "MPEG2-TS/RTP", only even numbers from 2 to 65530 can be specified for the port number.
- When [Type] is set to "MPEG2-TS/RTP" and [SMPTE 2022-1 FEC] is set to "On", N+2 and N+4 port numbers are also used in addition to the specified port number (N).

■ Port

Enter a SRT port number using an integer between 1 and 65535.

The default value is "6504".

Memo : _____

- This item is selectable only when [Type] is set to "SRT".

■ Stream ID

For setting the registered stream ID of the live distribution destination. It allows direct streaming of multiple cameras on a single device.

The default value varies with the product model.

* Enter not more than 63 characters.

Memo : _____

- Available when [Type] is set to "ZIXI" or "SRT".

■ Stream Key

Enter the stream key specified at the live transmission destination.

There is no default value (blank).

* Enter not more than 127 characters.

Memo : _____

- Available when [Type] is set to "RTMP" or "RTMPS".

■ Username

For setting the user name.

The default value is "jvc".

* Enter not more than 31 characters.

Memo : _____

- This item is selectable only when [Type] is set to "RTSP/RTP".

■ Password

For setting the [Stream ID] password.

For ZIXI, there is no default value (blank).

For RTSP/RTP, a random alphanumeric value that varies with each model is assigned as the default value.

* Enter not more than 127 characters. Enter not more than 31 characters for RTSP/RTP setting.

■ Latency

For setting the latency mode.

[Setting Values: High, Medium, ●Low, Min]

Memo : _____

- This item is selectable only when [Type] is set to "ZIXI".

■ PCR Mode

For configuring the low latency mode.

[Setting Values: Fast, ●Standard]

Memo : _____

- Available when [Type] is set to "MPEG2-TS/UDP", "MPEG2-TS/RTP", "ZIXI" or "SRT".
- Configuring to "Fast" minimizes the lag but the video image may be disrupted depending on the shooting and network conditions as priority is given to low latency. It is intended for use in a stable network environment to prevent packet loss from occurring.

■ Adaptive Bit Rate

If "On" is selected, the bit rate setting value of live streaming is set to maximum limit, and the bit rate is changed automatically according to changes in the network bandwidth.

[Setting Values: On, ●Off]

Memo : _____

- [Adaptive Bit Rate] can be configured when [Type] is configured to "ZIXI" or "SRT".

* The bit rate is displayed on the status screen only when "On" is set.

■ SMPTE 2022-1 FEC

Set to "On" to use FEC (Forward Error Correction). A transmission system that recovers the missing packets in the decoding process without having to retransmit the missing packets.

[Setting Values: On, ●Off]

* The decoder must be compatible with SMPTE 2022-1.

Memo : _____

- This item is selectable only when [Type] is set to "MPEG2-TS/RTP".

■ FEC Matrix

For setting the amount of FEC (Forward Error Correction) overhead for configuring SMPTE2022-1.

( P226 [Setting the FEC Matrix])

Memo : _____

- This item is selectable only when [SMPTE 2022-1 FEC] is set to "On".

■ Bandwidth Overhead

Enter the SRT bandwidth overhead using an integer between 5% and 100%. The default value is "25%".

Memo : _____

- This item is selectable only when [Type] is set to "SRT".

■ Latency

Enter the amount of SRT latency using an integer between 20 ms and 8000 ms. The default value is "500ms".

Memo : _____

- This item is selectable only when [Type] is set to "SRT".

■ Encryption

For configuring the SRT encryption mode.

[Setting Values: AES-256, AES-192, AES-128, ●Off]

Memo : _____

- This item is selectable only when [Type] is set to "SRT".

■ Passphrase

For configuring the SRT passphrase.

You can enter a passphrase between 10 to 79 characters. The default passphrase is generated randomly.

Memo : _____

- This item is selectable only when [Type] is set to "SRT".
- The passphrase can be configured when [Encryption] is configured to a setting other than "Off".

■ FEC

For configuring the FEC mode.

It enables recovery of data streaming packet loss without retransmission.

[Setting Values: 6x6, 8x8, 10x10, ●Off]

Memo : _____

- This item is selectable only when [Type] is set to "SRT".

Resolution

For setting the resolution of the video image during live distribution.

The available options vary according to the settings for [A Resolution] and [A Frame Rate] under [Record Format].

A Resolution	Setting Value
1920x1080	1920x1080, 1280x720, 640x360, 720x480 (U model), 720x576 (E model)
1280x720	1280x720, 640x360
720x480 (U model)	720x480
720x576 (E model)	720x576

Memo : _____

- The setting cannot be changed during live streaming (when [Live Streaming] set to "On").
- The Aspect Ratio for the live streaming image is fixed to "16:9".

Frame Rate

For setting the frame rate of the video image during live distribution.

The options vary according to the settings of [Live Streaming Set] → [Resolution] and the [A Frame Rate] settings under [Record Format].

A Frame Rate	Setting Value
60p, 60i	60p, 60i, 30p
50p, 50i	50p, 50i, 25p
30p	30p
25p	25p

Memo : _____

- The setting cannot be changed during live streaming (when live streaming is configured to "On").

Bit Rate

For setting the encode bitrate of the video image during live distribution.

The selectable options vary according to the settings in [Live Streaming Set] → [Resolution] and [Bit Rate].

For details on the settings, please refer to [Distributable [Record Format] and [Live Streaming Set] Combinations] (P 223).

Memo : _____

- The setting cannot be changed during live streaming (when [Live Streaming] set to "On").
- Depending on the type of network adapter used and the connection, images and audio sound during live streaming may be choppy.

Interlace Format

For configuring the interlace mode.

Configure the setting according to the decoder in use.

[Setting Values: Field, ●Field Pair]

Return over IP Item**Return over IP**

For configuring Return over IP to On/Off.

[Setting Values: On, ●Off]

Server

For selecting the source server for sending out Return over IP audio/video.

[Setting Values: ●Server1, Server2, Server3, Server4]

Memo : _____

- The setting cannot be changed while Return over IP is operating (when [Return over IP] is set to "On").

Return Server

For configuring the source server for sending out Return over IP audio/video.

Memo : _____

- The setting cannot be changed while Return over IP is operating (when [Return over IP] is set to "On").

↳ Server1, Server2, Server3, Server4

* The name that is set in [Alias] is displayed individually.

■ Alias

For setting a name to distinguish the settings of this camera.

The name set in this item will be displayed in the [Server] options.

*1 The default value is "Server1/Server2/Server3/Server4".

*2 You can enter up to 31 characters and ASCII characters.

■ Type

For configuring the system for transferring video and audio to be distributed.

[Setting Values: ●RTSP/RTP, ZIXI(SRT), Iccast]

Memo : _____

- Operates as IFB when the setting is configured to "Iccast".

- Use transmission devices that are compatible with the respective transfer systems.

- To use the "ZIXI" setting, a dedicated server is needed separately.

- SRT protocol update needs to be performed before using the SRT protocol. Doing so will make the Zixi protocol unusable.

To enable the use of the Zixi protocol again, perform Zixi protocol update.

- The following items that can be set vary depending on the setting of this item.

■ Protocol

For configuring the protocol of the video/audio source server to be connected.

[Setting Values: ●UDP, TCP]

Memo : _____

- This item is selectable only when [Type] is set to "RTSP/RTP".

■ Connection Mode

For configuring the SRT connection mode.

[Setting Values: ●Caller, Listener, Rendezvous]

Memo : _____

- This item is selectable only when [Type] is set to "SRT".

■ Source Address

For configuring details such as the host name and IP address of the video/audio transmission source. There is no default value (blank).

*1 A maximum of 191 ASCII characters can be entered when [Type] is configured to a setting other than "SRT".

*2 A maximum of 191 characters including single-byte alphanumeric characters (a to z, 0 to 9) and single-byte hyphen [-] and dot [.] can be entered when [Type] is configured to "SRT".

■ Source Port

Enter the network port number of the video/audio transmission source using an integer between 1 and 65535.

The default value is "554" when [Type] is set to "RTSP/RTP", "2077" when it is set to "ZIXI", and "5000" when it is set to Iccast.

Memo : _____

- When [Type] is set to "RTSP/RTP", only even numbers from 2 to 65530 can be specified for the port number.

■ Port

Enter a SRT port number using an integer between 1 and 65535.

The default value is "6510".

Memo : _____

- This item is selectable only when [Type] is set to "SRT".

■ Stream ID

For configuring the stream ID registered on the video/audio transmission source.

There is no default value (blank).

* Enter not more than 63 characters.

Memo : _____

- This item is available for setting when [Type] is set to "RTSP/RTP" or "ZIXI".

■ Username

For setting the user name.

There is no default value (blank).

* Enter not more than 63 characters.

Memo : _____

- This item is selectable only when [Type] is set to "RTSP/RTP".

■ Password

For setting the password.

There is no default value (blank).

* You can enter up to 31 characters when [Type] is set to "RTSP/RTP".

* You can enter up to 127 characters when [Type] is set to "ZIXI".

Memo : _____

- This item is available for setting when [Type] is set to "RTSP/RTP" or "ZIXI".

■ Name

For configuring the name.

The default value is "HC900".

* Enter not more than 31 characters.

Memo : _____

- This item is selectable only when [Type] is set to "ZIXI".

■ Latency

For setting the latency mode.

[Setting Values: Medium, ●Minimum, Off]

Memo : _____

- This item is selectable only when [Type] is set to "ZIXI".

■ Mountpoint

Enter the mountpoint (character string for identifying a stream) for streaming servers that support multiple streams.

There is no default value (blank).

* Enter not more than 63 characters.

Memo : _____

- This item is selectable only when [Type] is set to "Icecast".

■ Latency

Enter the amount of SRT latency using an integer between 20 ms and 8000 ms.

The default value is "20ms".

Memo : _____

- This item is selectable only when [Type] is set to "SRT".

■ Encryption

For configuring SRT encryption.

[Setting Values: On, ●Off]

Memo : _____

- This item is selectable only when [Type] is set to "SRT".

■ Passphrase

For configuring the SRT passphrase.

There is no default value (blank).

You can enter a passphrase between 10 to 79 characters.

Memo : _____

- This item is selectable only when [Type] is set to "SRT".
- This item is selectable when [Encryption] is set to a value other than "Off".

■ Resolution (Fixed)

This is fixed at "1280x720".

■ Frame Rate

For configuring the frame rate.

- When [Record Format] → [Frame Rate] is set to "60p", "60i" or "30p"

[Setting Values: ●60p, 30p]

- When [Record Format] → [Frame Rate] is set to "50p", "50i" or "25p"

[Setting Values: ●50p, 25p]

Memo : _____

- This item is available for setting only when [Type] is set to "RTSP/RTP", "ZIXI" or "SRT".

Web Item

Web Access

To access via a web browser, set to "On".
[Setting Values: ●On, Off]

Camera Name

For setting the name to be displayed on the web browser. Enter not more than 8 characters using the software keyboard.
(Default value: HC900)

Username

For setting the user name. Enter not more than 31 characters using the software keyboard.
(Default value: jvc)

Password

Changes the password for accessing via a web browser.
The current password is displayed. Enter a new password directly.
Enter not more than 31 characters using the software keyboard.
(Default value: random alphanumeric value that varies with each model)

Port

For configuring the port number during access to a web page from an external source.

Memo : _____

- Enter the name using the software keyboard.
- Enter an integer between 1 and 65535. (Default value: 80)
- To configure the setting to a number other than the default value, specify the number of an unused port.
- For more details, please consult the administrator of the network in use.

Metadata Server Item

Meta-FTP1, Meta-FTP2, Meta-FTP3, Meta-FTP4

* The name that is set in [Alias] is displayed individually.

■ Alias

For setting a name to distinguish the settings of this camera.

The name set in this item will be displayed in the [Import Metadata] options.

* Enter not more than 31 characters.

■ Protocol

For setting the protocol of the FTP server to be connected.

- FTP:
Protocol that does not encrypt the incoming and outgoing data.
- SFTP:
Protocol that encrypts incoming and outgoing data using SSH.
- FTPS:
Protocol that encrypts incoming and outgoing data using SSL or TLS. It uses an implicit mode (starts encrypted communication once connection starts).
- FTPES:
Protocol that encrypts incoming and outgoing data using SSL or TLS. It uses an explicit mode (starts encrypted communication after permission is granted).

[Setting Values: ●FTP, SFTP, FTPS, FTPES]

■ Server

For setting the server name ("mystation.com", etc.) or the IP address ("192.168.0.1", etc.) of the FTP server.

* Enter not more than 127 characters using single-byte alphanumeric characters (a to z, 0 to 9), single-byte hyphen [-], or dot [.]

■ Port

Enter the FTP server port number to use using an integer between 1 and 65535.

The default value varies with the protocol setting.
(FTP: 21, SFTP: 22, FTPS: 990, FTPES: 21)

■ File Path

Enter the path name for the metadata file ("/pub/meta.xml", "/home/user/meta2.xml", etc.)

- Enter not more than 127 characters.

■ Username

Enter the user name for connecting to the FTP server.

* Enter not more than 31 characters.

■ Password

Enter the password for connecting to the FTP server.

* Enter not more than 31 characters.

■ PASV Mode

For setting whether to set the communication mode used for file transfer to the passive mode. Set to "On" if the camera is inside a firewall, and a connection from the FTP server to the camera cannot be established.

[Setting Values: On, ●Off]

Memo : _____

- When [Protocol] is set to "SFTP", this item appears as "--" and cannot be selected.

Upload Item

Upload

For configuring the method for uploading to the FTP server.

- Auto:
Select this option for automatic FTP transfer. FTP transfer starts when [Auto Upload] is configured to "On".
- Manual:
Select this option for manual FTP transfer from the Media mode.

[Setting Values: ●Auto, Manual]

Auto Upload

When [Upload] is configured to "Auto", FTP transfer starts automatically when the setting is configured to "On".

[Setting Values: On, ●Off]

Memo : _____

- This is fixed at "Off" when [System] is set to "High-Speed".

↳ Slot

For selecting the recording media slot to enable automatic upload.

[Setting Values: ●A, B]

↳ Division

Automatically splits the clips and performs FTP transfer during recording at the preconfigured time when [System] is configured to "HD+Web".

[Setting Values: Off, 15 sec, ●30 sec, 45 sec, 60 sec, 90 sec, 3 min, 5 min, 10 min, 15 min]

Memo : _____

- [Slot] is fixed at "B".

↳ Cellular

For configuring whether to enable connection via a USB cellular adapter.

[Setting Values: Enable, ●Disable]

↳ Server

For configuring the server for uploading to the FTP server.

[Setting Values: ●Clip-FTP1, Clip-FTP2, Clip-FTP3, Clip-FTP4]

Clip Server

Clip-FTP1, Clip-FTP2, Clip-FTP3, Clip-FTP4

* The name that is set in [Alias] is displayed individually.

■ Alias

For setting a name to distinguish the settings of this camera.

The name set in this item will appear on the [FTP Upload] action screen of the thumbnail display.

* Enter not more than 31 characters.

■ Protocol

For setting the protocol of the FTP server to be connected.

- **FTP:**
Protocol that does not encrypt the incoming and outgoing data.
- **SFTP:**
Protocol that encrypts incoming and outgoing data using SSH.
- **FTPS:**
Protocol that encrypts incoming and outgoing data using SSL or TLS. It uses an implicit mode (starts encrypted communication once connection starts).
- **FTPES:**
Protocol that encrypts incoming and outgoing data using SSL or TLS. It uses an explicit mode (starts encrypted communication after permission is granted).
- **ZIXI:**
Enables stable transmission by reducing jitter and packet loss significantly through communicating via a relay server.

[Setting Values: ●FTP, SFTP, FTPS, FTPES, ZIXI]

Memo : _____

- To use the "ZIXI" setting, a dedicated server is needed separately.
- If "ZIXI" is set, the resume function is enabled.

■ Server

For setting the server name ("mystation.com", etc.) or the IP address ("192.168.0.1", etc.) of the FTP server.

* Enter not more than 127 characters using single-byte alphanumeric characters (a to z, 0 to 9), single-byte hyphen [-], or dot [.]

■ Port

Enter the FTP server port number to use using an integer between 1 and 65535.

The default value varies with the protocol setting. (FTP: 21, SFTP: 22, FTPS: 990, FTPES: 21, ZIXI: 2088)

■ Dir. Path

Enter the path name for the directory to upload to ("/pub", "/home/user", etc.)

* Enter not more than 127 characters.

■ Username

Enter the user name for connecting to the FTP server.

* Enter not more than 31 characters.

■ Stream ID

For configuring the stream ID that is registered at the distribution destination.

The default value varies with the product model.

* Enter not more than 63 characters.

Memo : _____

- This item is selectable only when [Type] is set to "ZIXI".

■ Password

Enter the password for connecting to the FTP server.

* Enter not more than 31 characters. Enter not more than 127 characters for ZIXI setting.

■ PASV Mode

For setting whether to set the communication mode used for file transfer to the passive mode.

Set to "On" if the camera is inside a firewall, and a connection from the FTP server to the camera cannot be established.

[Setting Values: On, ●Off]

Memo : _____

- When [Protocol] is set to "SFTP", this item appears as "---" and cannot be selected.

Overlay Settings Menu

This screen is used to configure overlay settings. Images can be overlaid onto recorded video and live stream video.

Overlay Function

For specifying whether to activate the overlay function.

[Setting Values: Enable, ●Disable]

Memo : _____

- The setting cannot be changed during recording, streaming or Return over IP.
- When [System] is configured to a setting other than “HD” and “HD+Web”, this item is fixed at “Disable”.
- When [Slot Mode] is set to “Backup **EXT1**”, this item is fixed at “Disable”.
- When “Disable” is selected, settings of the overlay function cannot be changed.

Layout

For selecting a SDP file.

Memo : _____

- Create a SDP file using SDP Generator in Windows or Mac before recording.

Import User Layout

Load the SDP file that is created by using SDP Generator onto this camera recorder.

Memo : _____

- Maximum 4 files can be saved in this camera recorder.
- The SDP file may not be saved depending on the available memory capacity of the camera recorder.

Delete User Layout

For deleting the SDP file.

Memo : _____

- The SDP file is not deleted by selecting [System] → [Reset All]. Delete the file from the camera recorder.

Type

By selecting [Type], overlay images can be displayed.

[Setting values: Broadcast, ●None]

Output

For specifying overlay output settings.

↳ REC

For setting whether to record overlay images together with the recorded video into an SD card.

- On:
Saves the video with overlay images into an SD card.
- Off:
Overlay images are not recorded into an SD card.

[Setting Values: ●On, Off]

Memo : _____

- Displays overlay images on the recording in slot B when [System] is configured to “HD+Web”.
- When the setting is configured to “Off”, live streaming is limited to a maximum bit rate of 12 Mbps.

↳ SDI OUT2

For setting whether to display overlay images on SDI OUT2 output.

- On:
Displays overlay images on streaming videos and SDI OUT2 output.
- Off:
Displays overlay images only on streaming videos.

[Setting values: ●On, Off]

↳ HDMI OUT

For setting whether to display overlay images on HDMI output.

- On: Displays overlay images on streaming videos and HDMI output.
- Off: Displays overlay images only on streaming videos.

[Setting Values: ●On, Off]

↳ VIDEO OUT

For setting whether to display overlay images on VIDEO OUT output.

- On: Displays overlay images on streaming videos and VIDEO OUT output.
- Off: Displays overlay images only on streaming videos.

[Setting values: ●On, Off]

↳ Live Streaming (Fixed)

Displays overlay images on live streaming videos. Setting is fixed at "On" and cannot be changed.

Watermark

Inserting watermarks (digital watermark) on recorded videos protects the content of your work.

- On: Displays watermark.
- Off: Does not display watermark.

[Setting Values: On, ●Off]

Memo : _____

- It can be displayed when the SDP file for which "Watermark" is preconfigured is selected in [Layout].

↳ Position

The display position of the watermark can be changed by using the cross-shaped button.

Full Screen Graphic

Images can be displayed across the whole screen.

↳ Status

For displaying the number of images saved in this camera recorder and the memory capacity used.

(P233 [Displaying Images on the Whole Screen (Full Screen Graphic Function)])

↳ Import Graphic **A** / **B**

For reading the images to be used in Full Screen Graphic from an SD card.

Memo : _____

- JPEG and PNG formats are supported.
- Enter not more than 31 characters for the file name.

↳ Delete Graphic

For deleting all images saved in this camera recorder.

Password Lock

The Overlay Settings menu can be locked with a password.

- On: A password is required to open the Overlay Settings menu.
- Off: Opens the Overlay Settings menu without a password.

[Setting Values: On, ●Off]

(P235 [Protecting Overlay Settings with a Password])

Caution : _____

- Do not forget the password that you have set. If the password is lost or forgotten, you cannot deactivate the password protection function.

System Menu

This menu screen allows system-related settings. For configuring recording settings, formatting and restoration of a recording media, tally lamp setting, date/time, time zone and other settings. It can also be used to reset the menu settings to their default values.

Record Set...

For specifying recorded video-related settings.
(☞ P160 [Record Set Item])

Media

↳ Format Media

For formatting (initializing) a recording media. Select a card slot, select [Format] from [Cancel]/[Format], and press the [STATUS/SET] button (●) to format (initialize) the card.
(☞ P51 [Formatting (Initializing) of Recording Media])

↳ Restore Media

For restoring a recording media. Select a card slot, and press the [STATUS/SET] button (●) to restore the SD card.
(☞ P52 [Repairing the Recording Media])

Memo : _____

- This item appears only when the recording media needs to be restored. However, it is not selectable when recording in Camera mode and during Clip Review.

Setup File

This allows you to save the menu settings as well as the performance results of shutter speed and AWB. It is useful to save settings according to different shooting conditions.

↳ Load File...

Loads the settings.
(☞ P187 [Loading a Setup File])

↳ Store File...

Saves the settings.
(☞ P186 [Saving Setup Files])

↳ Delete File...

Deletes the configured file.
(☞ P187 [Deleting Setup Files])

Tally System

For setting the display conditions of the tally lamp (front and back) on the camera recorder.

- Internal:
Displays mainly the status of the camera recorder.
- Studio:
Displays the TALLY IN/PREVIEW IN signals from an external device, such as a remote control unit.

[Setting Values: ●Internal, Studio]

Front Tally/Back Tally

For configuring how the front and back tally lamps on this camera recorder are illuminated when [Tally System] is set to "Internal" and while recording is in progress, when a remaining level warning is displayed or during live streaming.

- Rec/Live Streaming:
Lights up during recording or live streaming.
- Live Streaming:
Lights up during live streaming. Does not light up during recording.
- Rec:
Lights up during recording.

[Setting Values: Rec/Live Streaming, Live Streaming, ●Rec]

Memo : _____

- When [Tally System] is set to "Studio", this item appears as "---" and selection is disabled.

GPS **CHU** **CHE**

For setting the GPS function to On or Off (power on/off).

[Setting Values: On, ●Off]

Memo : _____

- When [A/V Set] → [Video Set] → [SDI OUT1 Res.] is set to "1080p", configuring [System] → [GPS] to "On" changes the setting to "1080".

CHU **CHE**

Battery

For configuring the warning voltage or warning level (%) according to the battery specifications and condition of use.

↳ **Type**

For configuring the battery warning using voltage or remaining level (%).

[Setting Values: Capacity%, ●Voltage]

Memo : _____

- For batteries where information on the remaining level cannot be acquired, the status will be the same as when “Voltage” is selected even when “Capacity%” is selected. To find out whether information on the remaining level can be obtained for the battery, check the remaining battery level icon on the display screen.

↳ **Near End (V)**

Outputs a warning sound when the voltage falls below the preset level.

[Setting value: 12.1 V to 14.0 V (●13.1 V)]

Memo : _____

- This cannot be configured to a value that is lower than the setting of [End (V)].

↳ **End (V)**

Outputs a warning sound upon reaching the preset voltage, and turns off the power automatically when the voltage falls below the preset level.

[Setting value: 12.0 V to 13.9 V (●12.8 V)]

Memo : _____

- This cannot be configured to a value that is higher than the setting of [Near End (V)].

↳ **Near End (%)**

Outputs a warning sound when the voltage falls below the preset level (%).

[Setting Values: 10 %, 15 %, ●20 %, 25 %, 30 %]

Memo : _____

- This cannot be configured to a value that is lower than the setting of [End (%)].
- A warning sound is also output when the voltage reaches 12.5 V or lower.

↳ **End (%)**

Outputs a warning sound upon reaching the preset level (%), and turns off the power automatically when the remaining level falls below the preset level.

[Setting Values: 1 %, 5 %, ●10 %, 15 %, 20 %]

Memo : _____

- This cannot be configured to a value that is higher than the setting of [Near End (%)].
- A warning sound is also output when the voltage reaches 12.0 V, and the power will turn off automatically when the voltage reaches 11.9 V or lower.

Language

Switches between languages in the menu screen.

[Setting Values: ●English, Français, Español] (U model)

[Setting Values: ●English, Français, Deutsch, Italiano, Español, Türkçe] (E model)

Reset All

Resets all menu settings.

Memo : _____

- [Date/Time] and [Time Zone] cannot be reset. (☞ P158 [Date/Time]) (☞ P159 [Time Zone])
- This item is not selectable when recording in Camera mode, during Clip Review, during live streaming and in Media mode.

Date/Time

For setting the year, month, day, hour, and minute.

Memo : _____

- The display order of the date (year, month, day) follows the setting in [Display Settings] ➔ [Date Style]. However, the 24-hour format is used for the hour display regardless of the [Time Style] setting. (☞ P159 [Time Style])
- If the signal reception for GPS satellites allows date and time to be set based on the GPS information, you can set the time obtained from the GPS satellite by pressing the [USER1] button. The [USER1] button is grayed out if information for setting the date and time cannot be acquired from the GPS satellite. **CHU CHE**
- When [NTP] in the Status screen (Network) becomes “Synchronized”, pressing the [USER3] button reflects the NTP time.

Date Style

For setting the date display sequence for display on the LCD monitor and viewfinder screen as well as for time stamp recording.

Display examples of the setting values are as follows.

- DMY2: 30 Jun 2020
- DMY1: 30-06-2020
- MDY2: Jun 30, 2020
- MDY1: 06-30-2020
- YMD: 2020-06-30

[Setting Values: DMY2, DMY1, MDY1, MDY2, YMD]

(Default values: MDY2 (U model), DMY1 (E model))

Time Style

For setting the time display for display on the LCD monitor and viewfinder screen as well as for time stamp recording.

[Setting Values: ●24hour, 12hour]

Time Zone

For setting the UTC time difference in units of 30 minutes.

[Setting Values: UTC-12:00-UTC-00:30, UTC, UTC+00:30-UTC+14:00 (in 30 min increments)]
(Default values: UTC-05:00 (U model), UTC (E model))

Memo : _____

- If [Date/Time] is already set, the [Date/Time] item is automatically adjusted when [Time Zone] is altered.

Reserved

For setting the additional function to "On" or "Off".

↳ Reserved 1 to Reserved 16

Normally set to "Off".

[Setting Values: On, ●Off]

System Information

↳ Version

Displays the version of the camera in the upper row and the version of the dedicated viewfinder in the lower row.

Display : 0000-0000
00-00-00

Memo : _____

- The lower row is displayed only when a viewfinder (supplied **CHU CHE** or separately sold **STU RCHE**) is connected .

↳ Fan Hour

For displaying the usage time of the internal fan.

Memo : _____

- Under normal environment, dust will accumulate on the internal fan when the camera recorder is used over a long period. Dust may enter the camera recorder especially if it is used outdoors. This may affect the image and sound quality of the camera recorder. Check and replace the fan after every 9000 hours (suggested guideline).

↳ Open Source License

Displays the license for the open source software used by this camera recorder.

Record Set Item

Record Format

After setting of all items in the [Record Format] menu is complete, select [Set] at the bottom of the screen to apply the new settings on the camera recorder and switch the recording format. A “Please Wait...” message appears during switching.

↳ System

For selecting a system definition.

- HD EXT (SSD):
Records videos in “HD EXT” quality to [Expansion slot] (SSD media).
- HD:
Records in “HD” (High Definition) quality for both slots A and B.
- SD:
Records in “SD” (Standard Definition) quality for both slots A and B.
- HD+Web:
Records in “HD” (high definition) for slot A, and in resolution suitable for web distribution for slot B.
- HD(SDI In):
Records the HD SDI video of the device connected to the [HD/SD SDI IN] terminal in “HD” to both slot A and slot B.
- SD(SDI In):
Records the SD SDI video of the device connected to the [HD/SD SDI IN] terminal in “SD” to both slot A and slot B.
- High-Speed:
Records slow motion videos in “HD” (High Definition) for both slot A and slot B.

[Setting Values: HD EXT(SSD), ●HD, SD, HD+Web, HD(SDI In), SD(SDI In), High-Speed]

Caution : _____

- The selectable options for the [A]Format/[EXT] Format], [A]Resolution/[EXT] Resolution], [A]Frame Rate/[EXT] Frame Rate], [A]Bit Rate/[EXT] Bit Rate],[A]Audio/[EXT] Audio], [B]Format], [B]Resolution], [B]Frame Rate], [B]Bit Rate] and [B]Audio] settings vary depending on the setting of this item.
 - When [System] → [Record Set] → [Record Format] → [System] is configured to “High-Speed”, network cannot be used via wireless LAN **CHU CHE** or the [HOST] terminal (USB). Configure as follows in this case.
 - Set [Network] → [Connection Setup] → [USB/Int. WLAN] to “Off”. **CHU CHE**
 - Unplug the USB network adapter
- Note that camera operation will come to an emergency stop and the power will turn off if the above steps are not performed.
File data may be damaged if this happens while recording is in progress.

↳ [A]Format/ [EXT]Format

For selecting the format of the file to be recorded to the recording media in slot A or Expansion slot.

- QuickTime(MPEG2):
QuickTime file format (.MOV)
- MXF(MPEG2):
MXF file format
- QuickTime(H.264):
QuickTime file format (.MOV)
- Exchange: (U model only)
Sports Video Interop Group format
- MP4(H.264): (E model only)
MP4 file format

[Setting Values: QuickTime(MPEG2), MXF(MPEG2), ●QuickTime(H.264), Exchange] (U model only)

[Setting Values: QuickTime(MPEG2), MXF(MPEG2), ●QuickTime(H.264), MP4(H.264)] (E model only)

Memo : _____

- When [System] is set to “HD EXT(SSD)”, this item is fixed at “ProRes”.
- When [System] is set to “SD” or “SD(SDI In)”, this item is fixed at “QuickTime(H.264)”.
- When [System] is set to “HD+Web”, this item is fixed at “QuickTime(H.264)”.
- When [System] is set to “High-Speed”, this item is fixed at “QuickTime(H.264)”.
- Exchange (U model) and MP4(H.264) (E model) are selectable only when [System] is configured to “HD” or “HD(SDI In)”.
- Exchange format is used under license from Sports Video Interoperability Group, Inc..

↳ **[A]Resolution/ [EXT] Resolution**

For selecting the size of the image to be recorded to the recording media in Slot A or the expansion slot. (Horizontal x vertical)

The available options vary according to the settings of [System] and [A]Format].

- When [System] is set to "HD EXT(SSD)":
Fixed at "1920x1080".
- When [System] is set to "HD" or "HD(SDI In)", and [A]Format] is set to "QuickTime(MPEG2)" or "MXF(MPEG2)":
[Setting Values: ●1920x1080, 1440x1080, 1280x720]
- When [System] is set to "HD" or "HD(SDI In)", and [A]Format] is set to "QuickTime(H.264)":
[Setting Values: 1920x1080, 1280x720]
- When [System] is set to "HD" or "HD(SDI In)", and [A]Format] is set to "Exchange" (U model only):
[Setting Values: 1920x1080, 1280x720]
- When [System] is set to "HD" or "HD(SDI In)", and [A]Format] is set to "MP4(H.264)" (E model only):
[Setting Values: 1920x1080, 1280x720]
- When [System] is set to "HD+Web":
[Setting Values: 1920x1080, 1280x720]
- When [System] is set to "High-Speed":
Fixed at "1920x1080".
- When [System] is set to "SD" or "SD(SDI In)":
Fixed at either "720x480" or "720x576".

Memo : _____

- The selectable values of [A]Frame Rate]/[EXT Frame Rate] and [A]Bit Rate]/[EXT Bit Rate] vary according to the setting of this item.

↳ **[A]Frame Rate/ [EXT] Frame Rate**

For selecting the frame rate for recording to the recording media in Slot A or the expansion slot.

The available options vary according to the settings for [System], [A]Resolution]/[EXT Resolution] and

[A]Format]/[EXT Format].

- When [System] is set to "HD EXT(SSD)":
[Setting Values: 60p, 50p, 30p, 25p, 24p]
- When [System] is set to "HD" or "HD(SDI In)", [A]Format] is set to "QuickTime(MPEG2)" or "MXF(MPEG2)", and [A]Resolution] is set to "1920x1080":
[Setting Values: 60i, 50i, 30p, 25p]
- When [System] is set to "HD", "HD(SDI In)" or "HD+Web", [A]Format] is set to "QuickTime(H.264)", and [A]Resolution] is set to "1920x1080":
[Setting Values: 60p, 60i, 50p, 50i, 30p, 25p, 24p]
- When [System] is set to "HD" or "HD(SDI In)" and [A]Resolution] is set to "1440x1080":
[Setting Values: 60i, 50i]
- When [System] is set to "HD", "HD(SDI In)" or "HD+Web" and [A]Resolution] is set to "1280x720":
[Setting Values: 60p, 50p]
- When [System] is set to "HD" or "HD(SDI In)", and [A]Format] to "Exchange":
Fixed at "60p". (U model only)
- When [System] is set to "HD" or "HD(SDI In)", and [A]Format] to "MP4(H.264)":
Fixed at "60p" or "50p".
- When [System] is set to "SD" or "SD(SDI In)":
Fixed at either "60i" or "50i".
- When [System] is configured to "High-Speed":
[Setting Values: 120/60p, 100/50p, 120/30p, 100/25p, 120/24p]

Memo : _____

- When [System] is configured to "HD(SDI In)", "30p"/"25p"/"24p" under [A]Frame Rate] cannot be selected.

↳ **A Bit Rate/ [EXT] Bit Rate**

For selecting the bit rate for recording to the recording media in Slot A or the expansion slot. The available options vary according to the settings for [System], [A Resolution]/[EXT Resolution] and [A Format]/[EXT Format].

- When [System] is set to “HD” or “HD(SDI In)”, [A Format] is set to “QuickTime(MPEG2)” or “MXF(MPEG2)”, and [A Resolution] is set to “1440x1080”:
[Setting Values: 35M (HQ), 25M (SP)]
- * When [A Resolution] is set to a setting other than “1440x1080”, it is fixed at “35M (HQ)”.
- When [System] is set to “HD”, “HD(SDI In)” or “HD+Web” and [A Format] is set to “QuickTime(H.264)”:
 - When [A Resolution] is set to “1920x1080”, and [A Frame Rate] is set to “60p” or “50p”:
[Setting Values: 4:2:2 100 70M (XHQ), 4:2:2 100 50M (XHQ), 50M (XHQ)]
 - When [A Resolution] is set to “1920x1080”, and [A Frame Rate] to “60i”/“50i”/“30p”/“25p”/“24p”:
[Setting Values: 4:2:2 100 50M (XHQ), 50M (XHQ), 35M (UHQ)]
 - When [A Resolution] is set to “1280x720”:
[Setting Values: 4:2:2 100 50M (XHQ), 35M (UHQ)]
- When [System] is set to “HD” or “HD(SDI In)”, and [A Format] is set to “Exchange” or “MP4(H.264)”:
 - When [A Resolution] is set to “1920x1080”: Fixed at “12M(LP)”.
 - When [A Resolution] is set to “1280x720”: Fixed at “8M(LP)”.
- When [System] is set to “SD” or “SD(SDI In)”: Fixed at 8M (HQ).
- When [System] is set to “High-Speed”:
 - When [A Frame Rate] is set to “120/60p” or “100/50p”
[Setting Values: 4:2:2 100 70M (XHQ), 4:2:2 100 50M (XHQ), 50M (UHQ)]
 - When [A Frame Rate] is configured to a setting other than “120/60p” and “100/50p”
[Setting Values: 4:2:2 100 50M (XHQ), 50M (XHQ), 35M (UHQ)]

Memo : _____

- When [System] is configured to “HD(SDI In)”, “30p”/“25p”/“24p” under [A Frame Rate] cannot be selected.

↳ **A Audio/ [EXT] Audio**

For selecting the audio (2ch/4ch) to be recorded to the recording media in Slot A or the expansion slot. The selectable options vary according to the settings in [A Format]/[EXT Format] or [A Bit Rate]/[EXT Bit Rate].

- When [A Bit Rate] is configured to a setting other than “4:2:2 100 70M (XHQ)” and “4:2:2 100 50M (XHQ)”:
[Setting Values: ●4CH 16 bit, 2CH 16 bit]
- When [A Bit Rate] is set to “4:2:2 100 70M (XHQ)” or “4:2:2 100 50M (XHQ)”:
[Setting Values: ●4CH 24 bit, 2CH 24 bit]

Memo : _____

- When [A Format] is configured to “Exchange” (U model) or “MP4(H.264)” (E model), the setting is fixed at “2CH”.
- When [System] is configured to “High-Speed”, the setting is fixed at “2CH”.

↳ **B Format**

For selecting the format of the file to be recorded to the SD card in slot B when [System] is configured to “HD+Web”. This is fixed at QuickTime (H.264).

Memo : _____

- When [System] is set to other than “HD+Web”, this item is fixed at the same setting as [A Format].

↳ **B Resolution**

For selecting the size of the image to be recorded to the SD card in slot B when [System] is configured to “HD+Web”. (Horizontal x vertical)

- When [System] is set to “HD+Web”:
 - When [A Frame Rate] is configured to “60p”/“60i”/“30p”
[Setting Values: 960x540, 720x480, 480x270]
 - When [A Frame Rate] is configured to “50p”/“50i”/“25p”
[Setting Values: 960x540, 720x576, 480x270]
 - When [A Frame Rate] is configured to “24p”
[Setting Values: 960x540, 480x270]

Memo : _____

- When [System] is set to other than “HD+Web”, this item is fixed at the same setting as [A Resolution].

↳ **B** Frame Rate

The frame rate of the image to be recorded to the SD card in slot B is fixed when [System] is set to "HD+Web".

The value fixed varies according to the settings for **[A]Frame Rate**.

- Fixed at "60i", "50i", "30p", "25p" or "24p".

Memo : _____

- When [System] is set to other than "HD+Web", this item is fixed at the same setting as **[A]Frame Rate**.

↳ **B** Bit Rate

The bit rate of the image to be recorded to the SD card in slot B is fixed when [System] is set to "HD+Web".

The value fixed varies according to the settings for **[B]Resolution**.

- "3M(HQ)" when **[B]Resolution** is configured to "960x540"
- "1.2M(LP)" when **[B]Resolution** is configured to "480x270"
- "8M(HQ)" when **[B]Resolution** is configured to "720x480" or "720x576"

Memo : _____

- When [System] is set to other than "HD+Web", this item is fixed at the same setting as **[A]Bit Rate**.

↳ **B** Audio

The audio (2ch/4ch) to be recorded to slot B is the same as the audio to be recorded to slot A.

↳ **SD Aspect**

For setting the aspect ratio of the image when [System] is set to "SD" or "SD(SDI In)".

[Setting Values: ●16:9, 4:3]

Memo : _____

- For conditions other than those above, this item is fixed at "16:9".

Rec Mode

- For selecting the mode for recording to the recording media.

(P92 [Special Recording])

[Setting Values: ●Normal, Pre Rec, Clip Continuous, Interval Rec, Frame Rec]

Memo : _____

- When [Slot Mode] is set to "Backup **B**" or "Backup **EXT**", this item is fixed at "Normal".
- This is fixed at "Normal" when [System] → [Record Format] → [System] is configured to any of the following.
 - HD(SDI In)
 - SD(SDI In)
 - HD EXT (SSD)
 - HD+Web
 - High-Speed

↳ **Pre Rec Time**

For setting the pre-recording time when [Rec Mode] is set to "Pre Rec".

[Setting Values: ●5sec, 10sec, 15sec]

↳ **Rec Frames**

For setting the number of frames to record when [Rec Mode] is set to "Frame Rec" or "Interval Rec".

[Setting Values: ●1frame, 3frames, 6frames]



↳ **Rec Interval**

For setting the recording time interval when [Rec Mode] is set to "Interval Rec".

[Setting Values: ●1sec, 2sec, 5sec, 10sec, 30sec, 1min, 2min, 5min, 10min, 30min, 1hour]

Slot Mode

For setting the operation of the card slot.

- **Series:**
Mode that activates slots A and B sequentially.
- **Dual:**
Mode that activates slots A and B simultaneously.
( P88 [Dual Rec])
- **Backup **B**:**
Mode that enables recording to slot B without using the [REC] button. This item is selectable only when [Rec Mode] is set to "Normal".
Record, start and stop operations can be controlled from the [Backup Rec] menu or using the user button that is assigned with "Backup Trig".
( P90 [Backup Rec])
- **Backup **EXT**:**
Mode that enables recording to the [expansion slot] without using the [REC] button. This item is selectable only when [Rec Mode] is set to "Normal".
Record, start and stop operations can be controlled from the [Backup Rec] menu or using the user button that is assigned with "Backup Trig".
( P90 [Backup Rec])

[Setting Values: ●Series, Dual, Backup **B**, Backup **EXT**]

Memo : _____

- When this is configured to "Series" and recordable media is inserted into slot A or slot B or both the slots, pressing the [REC] button starts recording only to the card in the selected slot (active slot).
- When this is configured to "Dual" and recordable media are inserted into both slots A and B, pressing the [REC] button starts simultaneous recording to the cards in both slots.
- When [System] is configured to "HD EXT(SSD)" "HD+Web", "---" is displayed.

↳ Backup Rec

For starting/stopping backup recording with [REC]/[STBY].

This item is selectable only when [Slot Mode] is set to "Backup **B**" or "Backup **EXT**".

Memo : _____

- When recording is stopped due to no remaining space on the media, etc., this item is fixed at "STOP" and cannot be selected.

4GB File Spanning(SDXC)

A recording file is automatically split when the size exceeds 4 GB, but if an SDXC card is used, you can record clips larger than 4 GB by setting this option to "Off". (Up to a maximum of 64 GB or 4 hours)

- **On:**
Splits a file when it exceeds 4 GB or 30 minutes.
- **Off:**
Splits a file when it exceeds 64 GB or 4 hours.

[Setting Values: ●On, Off]

Memo : _____

- This option is only valid if the SD card used for recording is of the SDXC format.
- During simultaneous recording, such as Dual Rec and backup recording, this option is valid only when the SD cards in slots A and B are of the SDXC format.

LPCM (QuickTime)

For setting the audio recording format of QuickTime.



[Setting Values: Dual Mono, ●Stereo]

Time Stamp

For setting whether to display shooting date/time information in the recorded video.

[Setting Values: On, ●Off]

Memo : _____

- The date/time display style can be changed in [Date Style]/[Time Style].
( P159 [Date Style])
( P159 [Time Style])
- When [System] is set to “High-Speed”, this item is fixed at “Off”.

Clip Set

↳ Clip Name Prefix

For configuring the first four characters of the name of the clip file to be recorded to the recording media. Enter any of the 36 characters including alphabets (upper case) and numbers (0 to 9) using the software keyboard.

( P109 [Text Input with Software Keyboard])

[Setting Values: xxxG] (The default value of xxx is the last three digits of the serial number.)

↳ Reset Clip Number

For assigning a new number (Clip Number) by resetting it (0001).

Select [Reset] and press the [STATUS/SET] button (●) to reset the number.

If there are other clips on the recording media, it will be assigned with the smallest available number.

- Example:
If the [Clip Name Prefix] is “ABCD” and “ABCD0001” already exists on the recording media, “ABCD0002” will be assigned.

Clear Planning Metadata

Erases the planning metadata downloaded from the FTP server.

This item also deletes the metadata loaded using the setup files (“User File”/“All File”).

Adding/Editing Frequently Used Menu Items (Favorites Menu)

You can select and add/edit frequently used menu items freely to create a personal menu screen (Favorites Menu).

Memo : _____

- [Favorites Menu] is only enabled in the Camera mode. [Favorites Menu] remains unchanged even when the recording format changes.
- Up to 20 menu items can be added.
- Added items in [Favorites Menu] will not be reset even when [Main Menu] → [Reset All] is executed.
- Long descriptive names may be displayed for the menu items in [Favorites Menu] to enable better understanding.

Adding Menu Items to Favorites Menu

- 1 Press the [MENU/THUMB] button to open the [Main Menu] screen.
- 2 Select the menu or submenu item to add.

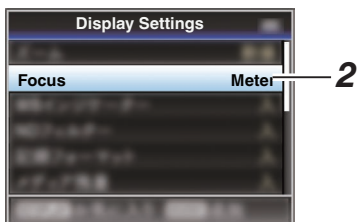

Memo : _____

- Adding items to [Favorites Menu] cannot be performed in the following cases. [USER1 Add] is displayed in gray in the operation guide.
 - Selected item is already added to [Favorites Menu].
 - Number of menu items that can be added (20 items) is exceeded.

- 3 Press the [USER1] button.
A screen to confirm the addition appears.
- 4 Select [Add] and press the Set button (●).
The selected menu item is added to [Favorites Menu].



Editing Favorites Menu

You can delete or change the order of the items added to [Favorites Menu].

Deleting Items from [Favorites Menu]

1 Open the [Favorites Menu] screen.

- 1 Press the [MENU/THUMB] button to open the [Main Menu] screen.
- 2 Press the [DISPLAY] button or press and hold down the [MENU/THUMB] button to open the [Favorites Menu] screen.

2 Select [Edit Favorites] and press the Set button (●) or crossed-shaped button (▶).

The header turns magenta and the editing mode is activated.

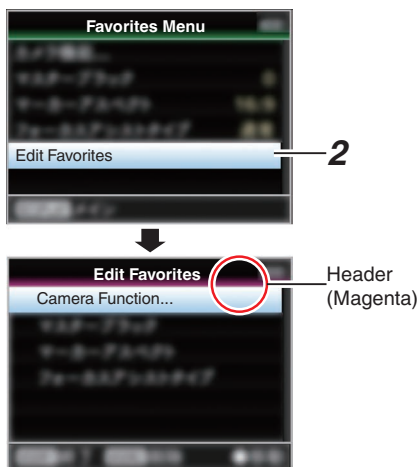

3 Select the menu or submenu item to delete.



4 Press the [USER2] button.

A delete mark (X) appears at the beginning of the menu item.

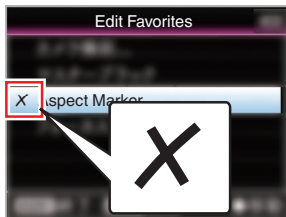

Memo :

- When the [USER2] button is pressed again while the menu item with the delete mark (X) is selected, the menu item will be excluded from the items to be deleted and the delete mark (X) disappears.

5 Press the [USER1] button.

The option menu to exit the [Favorites Menu] editing mode appears.

6 Select [Save & Exit] and press the Set button (●).

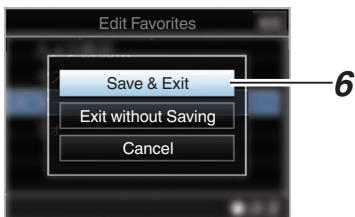

Memo :

- Deletion is not complete until the changes are saved with [Save & Exit].
- To exit the editing mode without deleting any items, select [Exit without Saving].
- To return to the editing mode, select [Cancel].

Changing the Order of Items in [Favorites Menu]

- 1 **Open the [Favorites Menu] screen.**
Press the [MENU/THUMB] button to open the [Favorites Menu] screen.
- 2 **Select [Edit Favorites] and press the Set button (●) or crossed-shaped button (▸).**
The header turns magenta and the editing mode is activated.

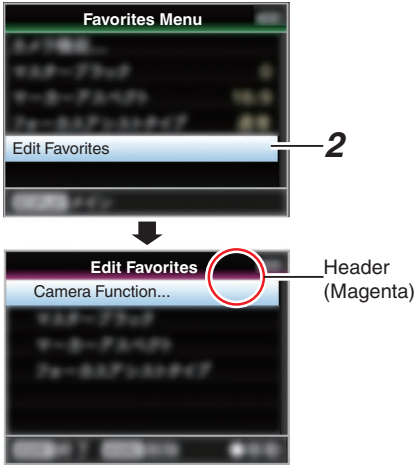

- 3 **Select the menu or submenu item to move and press the Set button (●).**
The moving mode is activated and a position selection bar for the move appears.

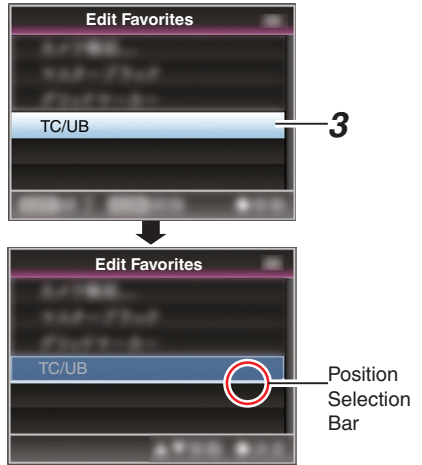

- 4 **Select the position to move to with the cross-shaped button (▲▼).**
Move the position selection bar with the cross-shaped button (▲▼) and select a position to move to.
- 5 **Press the Set button (●).**
The selected item moves to the new position.

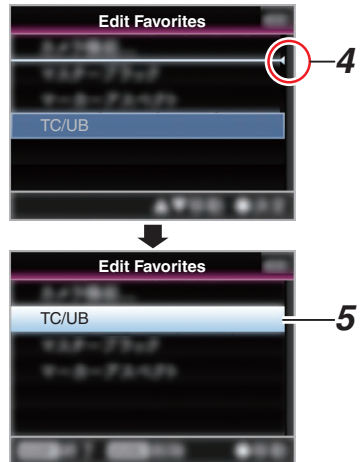

- 6 Press the [USER1] button.
The option menu to exit the [Favorites Menu] editing mode appears.
- 7 Select [Save & Exit] and press the Set button (●).

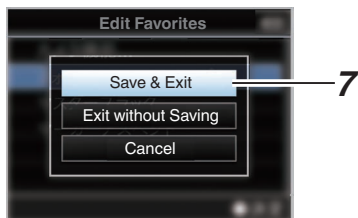

Memo : _____

- Moving is not complete until the changes are saved with [Save & Exit].
 - To exit the editing mode without saving any changes, select [Exit without Saving].
 - To return to the editing mode, select [Cancel].
- _____

Display Screen in Camera Mode

When the display setting for [LCD/VF] → [Display On/Off] is set to "Off", the corresponding display is hidden but it will appear for approximately 3 seconds when changes are being made.

Memo : _____

- When the display screen is turned off, it will appear only in the following cases.
 - Approximately 3 seconds when changes are being made
 - During event display or warning display

Display Screen

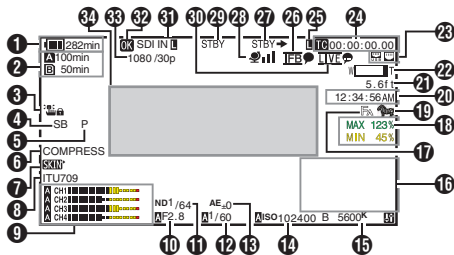

Enlarged Display

Enlarged Display (LCD Monitor Only)

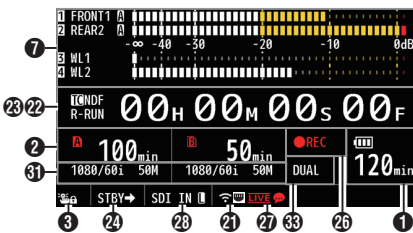

Memo : _____

- Only the display on the LCD monitor is enlarged.
- Voltage/Battery Power**
Displays the current status of the power supply in use.
(☞ P36 [Power Status Display])

Memo : _____

- Even when the display screen is turned off and [LCD/VF] → [Display On/Off] → [Battery] is set to "Off", this will be displayed when there is a warning.

- Remaining Space on Media**
Displays the remaining recording time for the recording media in slot A and slot B separately.

- A** : Currently selected slot. (White card)
- A** : Write-protect switch of SD card is set.
- A** : SD card cannot be read or written to, or restored.
- A** : SD card requires formatting.
- A** : SD card requires restoring.
- A** :
 - When the SD card is not supported.
 - When an SD card lower than Class 10 is inserted while in the XHQ mode.
- A** :
 - When attempting to record more than 4 GB while a media that does not support recording of more than 4 GB is inserted.
(☞ P164 [4GB File Spanning(SDXC)])

The following icons are displayed during FTP upload.

(☞ P200 [Uploading a Recorded Video Clip])

Icon	Status
	[Auto Upload] is configured to "On" and in the standby state. "A" is displayed at the top left corner of the icon while in the Auto FTP mode.
	Auto FTP transfer is in progress. Three images are alternately displayed, and the arrows become animated.
	FTP transfer is in progress. Three images are alternately displayed, and the arrows become animated.
	Error has occurred during FTP transfer.

Memo : _____

- The displayed time is an estimate.
- Even when the display screen is hidden and [LCD/VF] → [Display On/Off] → [Media Remain] is set to "Off", this will be displayed when there is a warning.
- You can view the status of FTP transfer during an upload under [Upload] on the Status screen.

3 Operation lock

The  icon appears during operation lock.
(☞ P54 [Operation Lock Feature])

Memo : _____

- The  icon appears for 3 seconds after operation lock is turned off.

4 Camera Angle[Tagging] **CHU** **STU**

Displays the camera angle tagging information when [AFormat] is configured to “Exchange”.

5 ODK[Tagging] **CHU** **STU**

Displays the ODK (Offence, Defence, Kick) tagging information when [AFormat] is configured to “Exchange”. It flashes in red when in the REMOVE mode.

6 Black Toe

Displays the Black Toe setting.

Memo : _____

- The “Normal” appears for 3 seconds after changing to Normal.

7 Skin Detail

 appears when Skin Detail is functioning.

Memo : _____

-  appears for 3 seconds after Skin Detail is turned off.

8 Color Space Display

Displays the color space.

Memo : _____

- This can be configured in [Camera Process] → [Color Space].
(☞ P118 [Color Space])

9 Audio Level Meter

- Displays the audio levels for CH-1 to CH-4.
-  appears on the screen when in the Auto mode.



- This is grayed out when in a mode that does not support audio recording or when the audio is not supported. The CH display is grayed out in the enlarged display mode.



- When in the enlarged display mode, the display changes with the setting of the [AUDIO INPUT CH1/CH2/CH3/CH4] selection switch.

Example: During 1ch and 3ch display

FRONT1: When the selection switch is set to “FRONT” and [Front Mic Select] is set to a value other than “Mono”

FR1+2: When the selection switch is set to “FRONT” and [Front Mic Select] is set to “Mono”

REAR1: When the selection switch is set to “REAR”



WL1: When the selection switch is set to “WIRELESS”

10 Iris F-Number

Displays F-number of the lens iris.

(☞ P61 [Adjusting the Iris])

Memo : _____

- This item may not be displayed depending on the lens used.
- A  icon appears on the left side of the lens aperture value (F-number) during Auto Iris mode.
- While in the Auto Iris mode, and [AE Lock] is set to “AE” or “AE/FAW”, a  icon appears on the left side of the lens aperture value (F-number) during lock operation.
(☞ P115 [AE Lock])

11 ND Filter Position

Displays the current ND filter position.

12 Shutter

- The current shutter speed appears on the screen.
(☞ P111 [Shutter])
- When the camera recorder is switched to the Full Auto shooting mode using the user button that is assigned with “Full Auto” or when it is switched to the Automatic Shutter mode with [Camera Function] ➔ [Shutter] set to “EEI”, the  icon appears on the left side of the shutter speed.

Memo : _____

- The variable range of the shutter speed varies according to the video format settings.
(☞ P63 [Setting the Electronic Shutter])
- While in the Automatic Shutter mode, and [AE Lock] is set to “AE” or “AE/FAW”, a  icon appears on the left side of the shutter speed during lock operation.
- [OFF] is displayed when the shutter is turned off or when in the Low-light shooting mode.

13 AE Level

- Displayed when the AE function is activated.
- When operated while manual operation is disabled, “AE” blinks for about 5 seconds.

14 Gain

- You can select to display the gain in “dB” or “ISO”.
(☞ P133 [Gain])
- Displays the gain value when in the Manual Gain mode.
- A  icon appears on the left side of the gain value in the “AGC” mode.
- “LUX” is displayed to the left of the gain value when in the Low-light shooting mode.

Memo : _____

- While in the “AGC” mode, and [AE Lock] is set to “AE” or “AE/FAW”, a  icon appears on the left side of the gain value during lock operation.

15 White Balance Mode

Displays the current white balance mode.
(*****K indicates color temperature)

- A *****K : When the [WHT BAL B/A/PRST] switch is set to “A” in the Manual White Balance mode.
- B *****K : When the [WHT BAL B/A/PRST] switch is set to “B” in the Manual White Balance mode.
- P *****K : When the [WHT BAL B/A/PRST] switch is set to “PRST” in the Manual White Balance mode.

 FAW : During Full Auto White Balance mode.

 FAW : While in the Full Auto White Balance mode, and [AE Lock] is set for “FAW” or “AE/FAW” during lock operation.

(☞ P66 [Preset Mode (PRST)])

(☞ P67 [Memory A Mode (A), Memory B Mode (B)])

Memo : _____

- When [Preset Paint], [AWB Paint] or [FAW Paint] is set to a setting other than the default value, a  icon is displayed to the right of the color temperature.



16 Expanded Focus/Video Signal Monitor/Return Video (PiP)

Displayed upon pressing the user button that is assigned with “Expanded Focus”, “Video Signal Monitor” and “Return Video” (PiP).

Memo : _____

- The order of display is “Expanded Focus” > “Video Signal Monitor” > “Return Video” (PiP).

17 Focus Assist

- “ ” is displayed when auto focus is activated.
- When ACCU-Focus is enabled, “ACCU  ” blinks for about 10 seconds while Focus Assist starts up, after which the “ ” indicator lights up.
- If recording starts while [ACCU-Focus] is active, [ACCU-Focus] will be forcibly deactivated.

(☞ P129 [Focus Assist])

- 18** Luminance Information
 Displayed when the Spot Meter function is activated.
 MAX : Maximum luminance
 MIN : Minimum luminance

- 19** Zebra pattern
 During zebra pattern display,  (zebra icon) is displayed on the display screen in Camera mode.
 (P82 [Setting Zebra Pattern])

- 20** Time Display
 Displays the current time.

Memo : _____

- The date/time display style can be configured in [System] → [Date/Time].
- When [System] → [Record Set] → [Time Stamp] is set to "On", this item is not displayed.

- 21** Focus Display
 Displays the approximate distance to the subject in focus during manual focus.

Memo : _____

- The displayed unit of measurement (feet or meter) can be configured in [LCD/VF] → [Display Type] → [Focus].
- This item may not be displayed depending on the lens used.

- 22** Zoom Display
 • Displays the zoom position. (Zoom bar or value)





W  **T**

- The zoom bar will only be displayed for 3 seconds after the zoom operation is activated.
- The value will always be displayed. (Z00 to 99)

Memo : _____

- The mode of display (value or bar) can be configured in [LCD/VF] → [Display Type] → [Zoom].
- This item may not be displayed depending on the lens used.

- 23** Network Connection Icon
- USB connection or built-in wireless LAN connection **CHU CHE**
 - Set [Network] → [Connection Setup] → [USB/Int. WLAN] to "On". **CHU CHE** (P144 [USB/Int. WLAN **CHU CHE**])
 - In the case of connecting to an external network, check the destination in [Network] → [Connection Setup] → [Default Gateway]. (P145 [Default Gateway])

Icon	Status
	Wireless LAN connection from the host terminal (USB) is established
	Wired LAN connection from the host terminal (USB) is established
	Cellular adapter connection from the host terminal (USB) is established
	When a USB adapter different from the connection settings is detected
	Built-in wireless LAN connection is established CHU CHE
(No display)	<ul style="list-style-type: none"> • When [USB/Int. WLAN] is set to "Off" CHU CHE • When an unusable USB adapter is detected

Memo : _____

- The icon appears blinking when the camera recorder is starting up, and is displayed in yellow while getting ready to connect.

- LAN terminal connection
 In the case of connecting to an external network, check the destination in [Network] → [Connection Setup] → [Default Gateway].

Icon	Status
	LAN terminal connection is established
(No display)	When the LAN cable is not connected

Memo : _____

- The icon appears blinking when the camera recorder is starting up, and is displayed in yellow while getting ready to connect.

24 Time Code (TC)/User's Bit (UB) Display

- Displays the time code (hour: minute: second: frame) or user's bit data.
- Example of time code display: Display Screen



* Colon (:) denotes non-drop frames and dot (.) denotes drop frames.

Enlarged Display

[NDF] is displayed to the right of [TC] in the case of non-drop frames and [DF] in the case of drop frames.



- Example of user's bit display: Display Screen



Memo : _____

- Use the [TC DISPLAY] switch to toggle between the time code display and user's bit display.

25 Time Code Lock Indicator

- When the built-in time code generator is synchronized to the external time code data input during the synchronization of time code with another camera recorder, [L] lights up. When in the enlarged display mode, [EXT L] is shown in the TC mode display.
- [L] lights up when [TC/UB] → [TC Mode] is configured to "NTP" and the unit has detected and synchronized to the NTP server. When in the enlarged display mode, [NTP L] is shown.
- [L] lights up when [TC/UB] → [TC Mode] is configured to "GPS" and the unit is synchronized to GPS. When in the enlarged display mode, [GPS L] is shown. **CHU CHE**

26 IFB/RET Mark

Displays the status of the IFB or Return over IP.

Icon	Status
	During audio feed only
 (Yellow)	When an error occurs during audio feed only
	During video+audio feed
 (Yellow)	When an error occurs during video+audio feed

27 SDI/HDMI Record Trigger

STBY → : When [SDI Rec Trigger] is set to "Type-A" or "Type-B", or [HDMI Rec Trigger] is set to "On" and recording is stopped

REC → : When [SDI Rec Trigger] is set to "Type-A" or "Type-B", or [HDMI Rec Trigger] is set to "On" and recording is in progress

28 GPS Mark **CHU CHE**

When [System] → [GPS] is set to "On", the signal reception status is displayed.

Memo : _____

- The display changes according to the signal reception sensitivity. If signals cannot be received, the [L] mark appears in yellow regardless of the [LCD/VF] → [Display On/Off] → [GPS] setting.
- This item is not displayed when [GPS] is set to "Off".



29 Media Status

- : A card is not detected in the selected slot, and [Tally System] is also not set to "Studio"
- STBY : Recording standby
- REC : Recording
- REVIEW : Clip Review
(☞ P86 [Viewing Recorded Videos Immediately (Clip Review)])
- STBY **P** : Pre Rec recording standby
(☞ P92 [Pre Rec])
- REC **P** : Pre Rec recording
(☞ P92 [Pre Rec])
- STBY **C** : Clip Continuous Rec recording standby
(☞ P93 [Clip Continuous Rec])
- REC **C** : Clip Continuous Rec recording
(☞ P93 [Clip Continuous Rec])
- STBY **C** : Clip Continuous Rec recording (displayed in yellow)
(☞ P93 [Clip Continuous Rec])
- STBY **I** : Interval Rec recording standby
(☞ P95 [Interval Rec])
- STBY **I** : Interval recording pause (displayed in red)
- REC **I** : Interval Rec recording
(☞ P95 [Interval Rec])
- STBY **F** : Frame Rec recording standby
(☞ P94 [Frame Rec])
- REC **F** : Frame Rec recording
(☞ P94 [Frame Rec])
- STBY **F** : Frame Rec recording pause (displayed in yellow)
(☞ P94 [Frame Rec])
- STOP : Unable to record to the card in the slot
- P.OFF : Power OFF
- < : During clip cutter recording (displayed for 3 seconds)
(☞ P96 [Splitting the Clips Freely (Clip Cutter Trig)])
- CALL : Receiving call signals from an external device, such as a remote control unit
- PGM : Receiving program signals from an external device, such as a remote control unit
- PVV : Receiving preview signals from an external device, such as a remote control unit

30 Live streaming mark

When [Network] → [Live Streaming] → [Live Streaming] is set to "On", the distribution status is displayed.

(☞ P145 [Live Streaming Item])

Icon	Status
 (Red)	Distribution in progress (good connection quality)
 (Red)	Distribution in progress (poor connection quality)
 (Yellow)	Waiting for connection (RTSP/RTP only), connection failed

31 SDI Input Mode/High-Speed Frame Rate

- "SDI IN" is displayed when a device is connected to the [HD/SD SDI IN] terminal, and [System] → [Record Set] → [Record Format] → [System] is set to "HD(SDI In)" or "SD(SDI In)".
- When [System] → [Record Set] → [Record Format] → [System] is configured to "High-Speed", the setting value for [A] Frame Rate is displayed.

32 OK Mark

Displayed when OK mark has been appended.
(☞ P103 [Appending/Deleting OK Mark])

33 Recording Format/Bit Rate (Enlarged Display Mode Only)

Displays the recording format and bit rate (only when in the enlarged display mode).

Memo : _____

- The resolution, frame rate and bit rate can be viewed on the status screen.

34 Event/Warning Display Area

Displays error messages.
(☞ P237 [Error Messages and Actions])

35 Dual Rec/ Backup Rec Display (Enlarged Display Mode Only)

"DUAL" is displayed in the Dual Rec mode and "BACKUP" is displayed in the Backup Rec mode.
(☞ P164 [Slot Mode])

Memo : _____

- Displayed only when in the enlarged display mode.

Display Screen in Media Mode

When the display setting for [LCD/VF] → [Display On/Off] is set to "Off", the corresponding display is hidden.

Memo : _____

- Display on the information display area can be toggled using the [USER4] button.
- When the display screen is turned off, it will appear only in the following cases.
 - During event display or warning display
- If "VF Display" is assigned to the [USER1(VF)] button or [USER2(VF)] button of the viewfinder, the corresponding button can also be used in the Media mode.

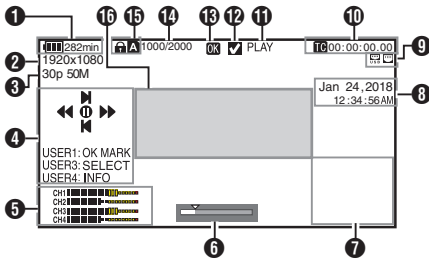

- 1 Voltage/Battery Power**
Displays the current status of the power supply in use.

(P36 [Power Status Display])

Memo : _____

- Even when the display screen is turned off and [LCD/VF] → [Display On/Off] → [Battery] is set to "Off", this will be displayed when there is a warning.

- 2 Resolution**
Displays the video image resolution.

- 3 Frame Rate/Bit Rate**
Displays the frame rate and bit rate in pairs.

- 4 Operation Guide**
Displays a guide for the current operation buttons.

- 5 Audio Level Meter**
 - Displays the audio levels for CH-1 to CH-4.



- 6 Position Bar**
Displays the current position in the video. During trimming, the position bar appears in green, and icons for the in and out points are displayed.

- ▼ : Current position of the video
- ▲ : Position to start trimming (In point)
- ▲ : Position to end trimming (Out point)

7 Information Display

Use the [USER4] button to switch between camera information display, GPS display and turning off the display.

- The GPS display displays information on the recording location of the video being played back only when GPS information has been recorded.
- Camera information display displays only information of Gain, Iris, Shutter and White Balance that have been recorded.

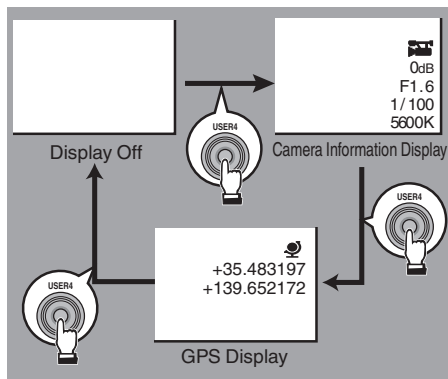

Memo : _____

- Trimming information is displayed while trimming is in progress. In this case, pressing the [USER4] button does not switch the display.
- The information display area is not subject to the display settings of the items in [LCD/VF] → [Display On/Off].

8 Date/Time Display

Displays the date/time that is recorded on the currently played recording media.

Memo : _____

- The date/time display style can be specified in [System] → [Date Style]/[Time Style].
(☞ P159 [Date Style])
(☞ P159 [Time Style])

9 Network Connection Icon

- USB connection or built-in wireless LAN connection **CHU CHE**
 - Set [Network] → [Connection Setup] → [USB/Int. WLAN] to "On". **CHU CHE**
(☞ P144 [USB/Int. WLAN **CHU CHE**])
 - In the case of connecting to an external network, check the destination in [Network] → [Connection Setup] → [Default Gateway].
(☞ P145 [Default Gateway])

Icon	Status
	Wireless LAN connection from the host terminal (USB) is established
	Wired LAN connection from the host terminal (USB) is established
	Cellular adapter connection from the host terminal (USB) is established
	When a USB adapter different from the connection settings is detected
	Built-in wireless LAN connection is established CHU CHE
(No display)	<ul style="list-style-type: none"> • When [USB/Int. WLAN] is set to "Off" CHU CHE • When an unusable USB adapter is detected

Memo : _____

- The icon appears blinking when the camera recorder is starting up, and is displayed in yellow while getting ready to connect.

- LAN terminal connection

In the case of connecting to an external network, check the destination in [Network] → [Connection Setup] → [Default Gateway].

Icon	Status
	LAN terminal connection is established
(No display)	When the LAN cable is not connected

Memo : _____

- The icon appears blinking when the camera recorder is starting up, and is displayed in yellow while getting ready to connect.

- ⑩ Time Code (TC)/User's Bit (UB) Display
- Displays the time code (hour: minute: second: frame) or user's bit data recorded in the recording media being played back.
 - Example of time code display:

00:00:00:00

↓
*

* Colon (:) denotes non-drop frames and dot (.) denotes drop frames.

- Example of user's bit display:

UBFF EE DD 20

Memo : _____

- Use the [TC DISPLAY] switch to toggle between the time code display and user's bit display.

⑪ Media Status

PLAY : Playing
 STILL : Still picture playback mode
 FWD * : High-speed playback in the forward direction (* playback speed: 5x, 15x, 60x, or 360x)
 REV * : High-speed playback in the reverse direction (* reverse playback speed: 5x, 15x, 60x, or 360x)
 STOP : Stop mode
 P.OFF : Power OFF

- ⑫ Check Mark
 Displayed when the currently played clip is selected.

- ⑬ OK Mark
 Displayed when OK mark has been appended.
 (☞ P103 [Appending/Deleting OK Mark])

- ⑭ Clip Information
 Displays current clip number/total number of clips.

- ⑮ Media
- Displays the media slot (A or B) of the currently played clip.
 -  appears when the write-protect switch of the SD card is set.

- ⑯ Event/Warning Display Area
 Displays error messages.
 (☞ P237 [Error Messages and Actions])

Status Screen

For checking the settings of the camera recorder.

USER Switch Set Screen

For checking the status (functions assigned) of the user buttons.

( P45 [Assignment of Functions to User Buttons])

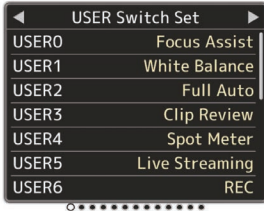

Camera Screen

For checking information related to shooting using the camera recorder.

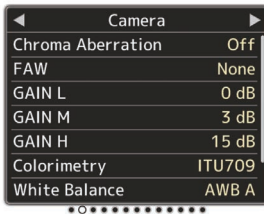

LCD/VF Screen

For checking information related to the contents displayed on the LCD monitor and viewfinder screens.

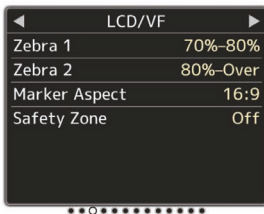

Record Format Screen

For checking settings related to the recording format.

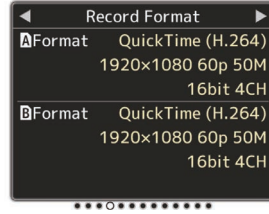

Audio Input Screen

For checking settings related to audio input channels and their input levels.



Audio Output Screen

For checking settings related to audio output channels and their output levels.



Video Screen

For checking the settings related to video output.



Power Screen

For checking the power consumption.

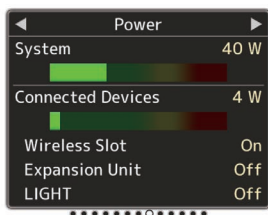

Memo : _____

- [System] shows the power consumption of the entire camera system (camera recorder + connecting devices) while [Connected Devices] shows the estimated power consumption of the peripheral equipments such as lens and wireless slots.
- When the bar on the bar graph enters the red zone, it indicates that the power consumption has exceeded its rating. As this may result in malfunction, do keep the power consumption within the rating.
- If [System] shows a value that exceeds the rating, the power to the [LIGHT], [DC OUT] (rear) and [DC OUT] (LAN) terminals is automatically cut off. This is not a malfunction. Use peripheral equipments with lower power consumption then turn on the power of this camera recorder again.

Planning Metadata Screen

For checking the current planning metadata setting.

(P205 [Planning Metadata])

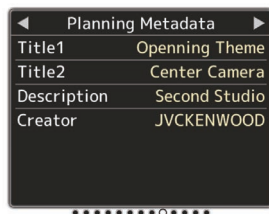

Network Screen

For checking the network login information.

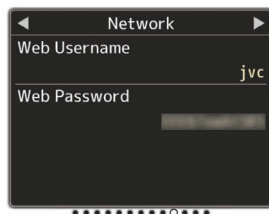

LAN Screen

For checking the network information for LAN connection.

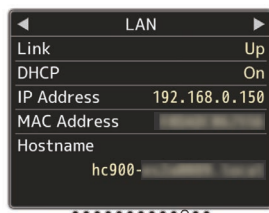

USB/Int. WLAN Screen CHE CHE USB Screen STU RCHE

For checking the network information for the USB adapter and built-in wireless LAN connections.

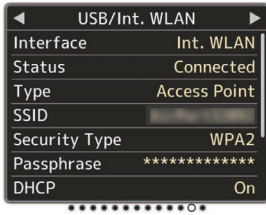

Streaming Screen

For viewing information related to live streaming.

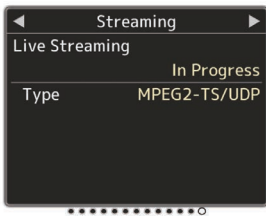

Upload Screen

For checking the FTP transfer status during an upload.

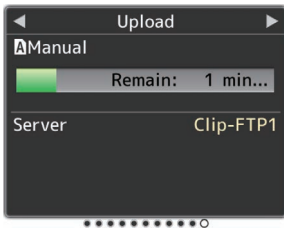

Marker and Safety Zone Displays (Camera Mode Only)

The marker and safety zone displays are useful in helping you determine the angle of view for the image according to the shooting purpose. The marker is displayed only in the Camera mode.

Displaying the Grid Marker

- 1 Set [LCD/VF] → [Marker Settings] → [Grid Marker] to "On".
(P131 [Grid Marker])
A grid that divides the screen into 3x3 is displayed.



Memo : _____

- When [Grid Marker] is set to "On", [Aspect Ratio], [Aspect Marker], and [Safety Zone] do not function.
- Example of display when [Aspect Ratio] = "4:3", [Aspect Marker] = "Line+Half-tone", and [Center Mark] = "On"

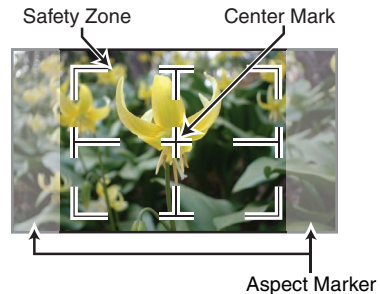

Memo : _____

- You can turn On/Off the safety zone and center mark displays using [LCD/VF] → [Marker Settings] → [Aspect Ratio], [Safety Zone], and [Center Mark].
( P131 [Safety Zone])

Color Bar Output

Color bars can be output on this camera recorder.

Memo : _____

- The audio test signals (1 kHz) can be output simultaneously with the color bar output.
( P140 [Test Tone])

To output color bars, follow the setting procedure below.

- 1 Set the [OUTPUT] switch to “BARS”.
Color bars are output.

Adjusting the Gamma

The gamma curve can be adjusted to various characteristics when Color Space is set to a value other than “HLG” and “J-Log1”.

( P118 [Color Space])

( P118 [Gamma])

- Standard** : Standard gamma curve based on video standard.
The adjustable level is 0.35 to 0.45 to 0.55 in steps of 0.01.
When the level is at 0.45, the gamma curve becomes one that conforms to the ITU709 standard.
- Cinema 1** : Sets to a cinema-like gamma curve.
The level can be adjusted extensively from -10 to 0 to +10.
- Cinema 2** : Sets to a gamma curve with soft expression giving priority to high luminance gradation.
The level can be adjusted extensively from -10 to 0 to +10.

Gamma Variation

The typical characteristics are shown in the following figure. The figure shows the characteristics when “Standard”, “Cinema 1” or “Cinema 2” is configured and [Knee Level] is set to “95%” for the “Standard” or “Cinema 1” graph.

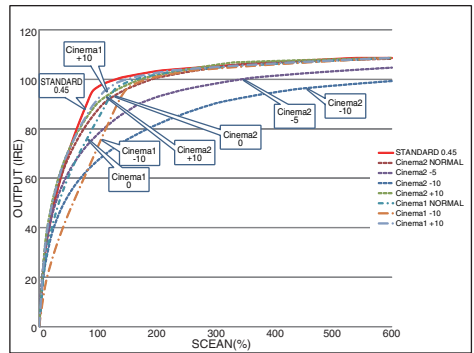

HLG and J-Log1 Gamma

The gamma switches automatically to the respective “HLG Gamma” and “J-Log1 Gamma” when [Color Space] is set to “HLG” or “J-Log1”. The HLG Gamma becomes an ITU2100 HLG HDR gamma. Output signals above 100 IRE can be clipped by adjusting “White Clip”.

The J-Log1 Gamma becomes a Log gamma with dynamic range of max 800%.

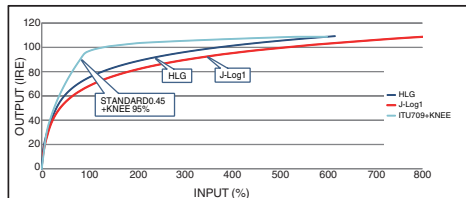

Adjusting Color Matrix

- The color matrix of the camera recorder can be adjusted to a color of the user’s preference.
- When shooting is performed using multiple cameras, the colors of the different cameras can be adjusted, and a color of the user’s preference can be set on this camera recorder.
- Adjust the color on the vector scope and waveform monitor using the DSC color chart.
- * The adjusted values of “Natural”, “Standard”, “Cinema Vivid”, and “Cinema Subdued” in [Color Matrix] can be stored individually. (P121 [Color Matrix])

Linear Matrix Adjustment

The Saturation, Hue and Lightness of the primary and complementary colors (6 colors in total) can be set individually.

1 Set [Camera Process] → [Color Matrix]/ [Adjust] → [Linear Adjust] to "On" and select [Adjust].

(P121 [Color Matrix])

2 Adjust Hue.

- Select the color using the cross-shaped button (▲▼) and confirm using the cross-shaped button (▶). (The cursor moves to Hue.)
- Pressing the cross-shaped button (▲) rotates the hue in the clockwise direction on the vector scope.
- Pressing the cross-shaped button (▼) rotates the hue in the anti-clockwise direction on the vector scope.

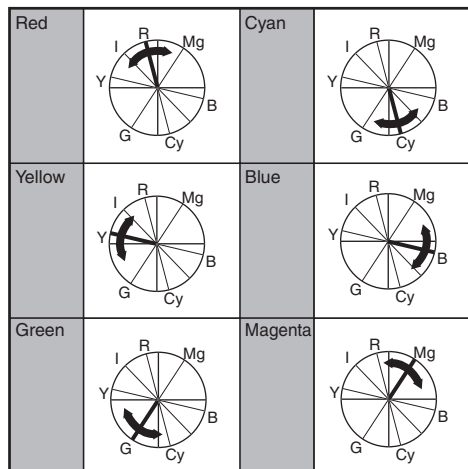

3 Adjust Saturation.

- Press the cross-shaped button (▶) to move the cursor to Saturation.
- Each of the colors changes in the direction indicated by the arrow on the vector scope.
- Pressing the cross-shaped button (▲) moves the color outward from the center of the circle on the vector scope.
- Pressing the cross-shaped button (▼) moves the color toward the center of the circle on the vector scope.

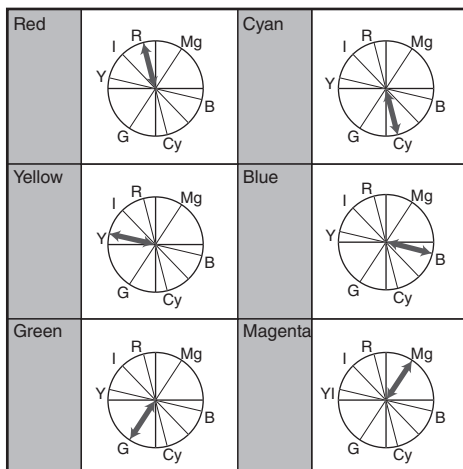

4 Adjust Lightness.

- Pressing the cross-shaped button (▲) lightens; and pressing the cross-shaped button (▼) darkens.
- Press the cross-shaped button (▶) to return the cursor to Hue.

Multi-Matrix Adjustment

Multi-matrix adjustment is capable of advanced configuration of the Saturation and Hue for 16 colors than linear adjustment.

1 Set [Camera Process] → [Color Matrix]/ [Adjust] → [Multi Adjust] to “On” and select [Adjust].

(☞ P121 [Color Matrix])

2 Adjust Hue.

- Select the color using the cross-shaped button (▲▼) and confirm using the cross-shaped button (▶). (The cursor moves to Hue.)
- Pressing the cross-shaped button (▲) rotates the hue in the clockwise direction on the vector scope.
- Pressing the cross-shaped button (▼) rotates the hue in the anti-clockwise direction on the vector scope.

3 Adjust Saturation.

- Press the cross-shaped button (▶) to move the cursor to Saturation.
- Pressing the cross-shaped button (▲) moves the color outward from the center of the circle on the vector scope.
- Pressing the cross-shaped button (▼) moves the color toward to the center of the circle on the vector scope.

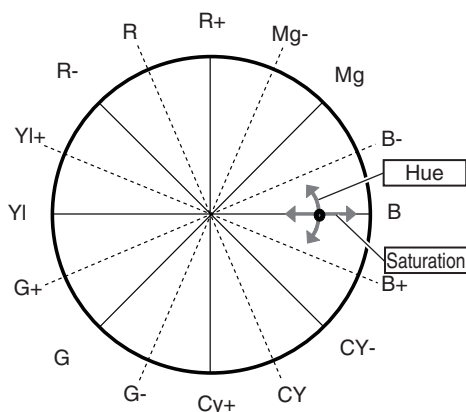

Configuring Setup Files

The menu settings can be stored on an SD card by saving them as a setup file.

Loading a saved setup file enables you to reproduce the appropriate setup state speedily. The following types of setup files are available.

Picture File:

File that contains image creation settings in accordance to the shooting conditions ([Camera Process] menu items).

All File:

File that contains all menu settings, ranging from video format settings to image creation settings such as device settings and shooting conditions, as well as the contents of the [Favorites Menu]. Settings in Network Settings are not saved.

User File:

File that contains settings from All File that are not included in the [Camera Process] menu items.

(☞ P118 [Camera Process Menu])

Memo : _____

- Make use of the [Setup File] menu to save or load a setup file.
- The following operations can be performed on the [Setup File] menu.
 - [Saving Setup Files] (☞ P 186)
 - [Loading a Setup File] (☞ P 187)
- Even when [Record Format] → [System] is configured to “HD EXT(SSD)”, setup files will be saved to this camera recorder or the SD card.

Number of Storable Setup Files

SD slot A : [A 1] to [A 8]
SD slot B : [B 1] to [B 8]

Compatibility

- User File/All File
 - Only User File/All File of the GY-HC900 series can be loaded.
- Picture File
 - Only Picture File of the GY-HC900 series can be loaded.

Saving Setup Files

- 1 **Display the [Setup File] menu.**
Select [System] → [Setup File] and press the Set button (●).
(P157 [Setup File])
- 2 **Select [Store File] and press the Set button (●).**
- 3 **Select [Picture File], [User File] or [All File], and press the Set button (●).**
The existing files are displayed.
- 4 **Select the file to be newly saved (or overwritten) using the cross-shaped button (▲▼), and press the Set button (●).**

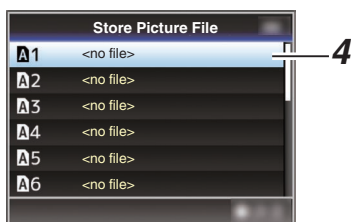

Memo : _____

- Files cannot be written in the following cases. (Displayed in gray, selection disabled)
 - When the inserted SD card is not supported or not formatted. (File name appears as “---”.)
 - When a write-protected SD card is inserted (a lock mark appears beside the SD card icon).

5 Name the file.

- Enter the surname using the software keyboard.
- (P109 [Text Input with Software Keyboard])
- You can enter up to 8 characters for the [Store File]/[Picture File] surname.

Memo : _____

- When overwriting an existing file, the surname of the existing file is displayed.
- Select [Cancel] and press the Set button (●), or press the [CANCEL/RESET] button to return to the previous screen.

- 6 **Select [Store] and press the Set button (●).**



7 Save the file.

- A confirmation screen appears when you choose to overwrite.
Select [Overwrite] on the confirmation screen, and press the Set button (●). Saving starts, and “Storing...” appears on the screen.

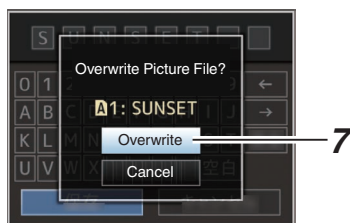

- Saving starts, and “Storing...” appears on the screen when the file is newly saved.

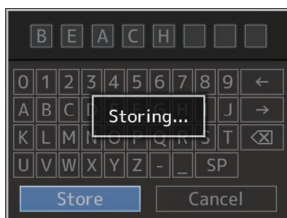

8 Saving is complete.

- After saving of the file is complete, “Complete” appears on the screen, and the menu screen closes automatically.

Loading a Setup File

- 1 **Display the [Setup File] menu.**
Select [System] → [Setup File] and press the Set button (●).
(☞ P157 [Setup File])
- 2 **Select [Load File] and press the Set button (●).**
- 3 **Select [Picture File], [User File] or [All File], and press the Set button (●).**
The existing files are displayed.
- 4 **Select the file to load using the cross-shaped button (▲▼), and press the Set button (●).**

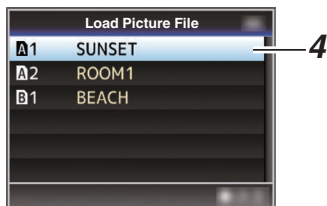

Memo : _____

- When the write-protect switch of the inserted SD card is set, a lock mark appears beside the SD card icon. Setup files can be loaded from an SD card even if the write-protect switch is set.
- Setup files that are completely incompatible will not be displayed.
(☞ P185 [Configuring Setup Files])

- 5 **Select [Load] on the confirmation screen, and press the Set button (●).**
Loading starts, and "Loading..." appears on the screen.

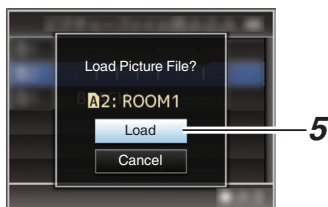

- 6 **Reading is complete.**
After reading of the file is complete, "Complete" appears on the screen, and the menu screen closes automatically.

Deleting Setup Files

- 1 **Display the [Setup File] menu.**
Select [Main Menu] → [System] → [Setup File] and press the Set button (●).
(☞ P157 [Setup File])
- 2 **Select [Delete File] and press the Set button (●).**
- 3 **Select [Picture File], [User File] or [All File], and press the Set button (●).**
The existing files are displayed.
- 4 **Select the file to delete using the cross-shaped button (▲▼), and press the Set button (●).**

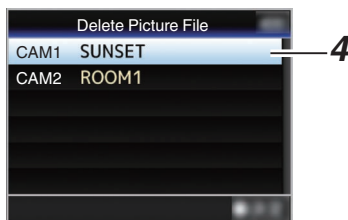

Memo : _____

- Setup File saved on the SD card cannot be deleted.
- 5 **Select [Delete] on the confirmation screen, and press the Set button (●).**
Deletion starts, and "Deleting..." appears on the screen.

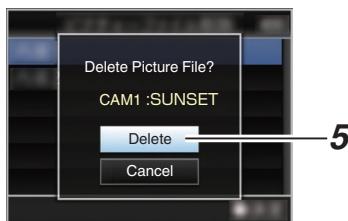

- 6 **Deletion is complete.**
After file deletion is complete, "Complete" appears on the screen.

Connecting External Monitor

- To output live or playback video images and audio sound to an external monitor, select the output signals from the camera recorder, and connect using an appropriate cable according to the monitor to be used.
- Choose the most suitable terminal according to the monitor in use.
- [HD/SD SDI OUT] terminal:
Outputs either the 3G-SDI/HD-SDI signal or SD-SDI signal.
- [VIDEO OUT] terminal:
Outputs composite video signals.
- [HDMI] terminal:
Outputs HDMI signals.

Memo : _____

- If the [HD/SD SDI OUT] terminal or [HDMI] terminal is connected, configure the settings in the [A/V Set] menu according to the monitor to be connected.
(☞ P134 [SDI OUT1])
(☞ P134 [SDI OUT2])
(☞ P136 [HDMI OUT])
(☞ P137 [VIDEO OUT])

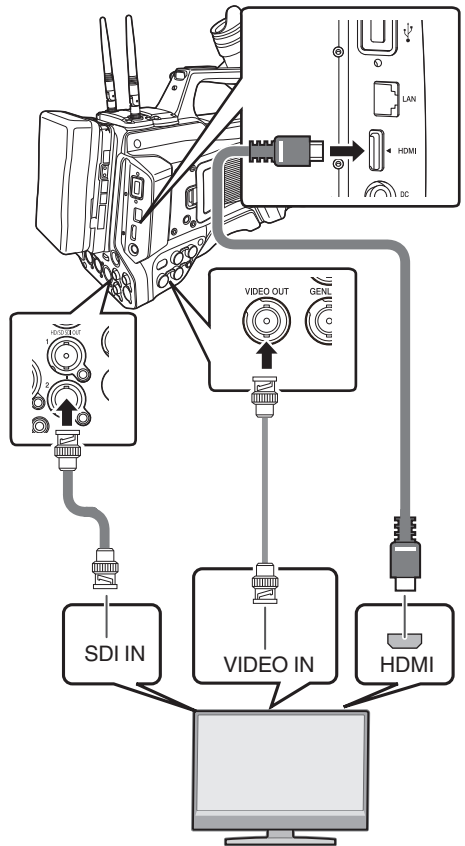

- * Select the output signal in [A/V Set] → [SDI OUT1]/[SDI OUT2]/[HDMI OUT].
(☞ P134 [SDI OUT1])
(☞ P134 [SDI OUT2])
(☞ P136 [HDMI OUT])
- * When [Record Format] → [System] is set to "SD", only SD-SDI signals are output.
(☞ P160 [System])
- * To display the menu screen or display screen on the external monitor, set [A/V Set] → [Video Set] → [SDI OUT2] → [Character]/[HDMI OUT] → [Character]/[VIDEO OUT] → [Character] to "On".
(☞ P134 [Character (SDI OUT2)])
(☞ P136 [Character (HDMI OUT)])
(☞ P137 [Character (VIDEO OUT)])

Connecting via SDI

- Digital video signals, together with embedded (superimposed) audio signals and time code signals, are output for both the 3G-SDI/HD-SDI and SD-SDI signals.

Memo : _____

- The sampling frequency for embedded (superimposed) audio signals is 48 kHz. Time code of the built-in time generator as well as playback time code are also output.

Setting the Aspect

- For setting the mode to convert images with a 16:9 aspect ratio to display on a 4:3 aspect ratio screen.
- Set using [A/V Set] → [Video Set] → [SD Aspect].
- The available modes include “Side Cut”, “Letter” (blackened at the top and bottom), and “Squeeze” (full size, compressed at the left and right).

(☞ P137 [SD Aspect])

Memo : _____

- When [Record Format] → [System] is set to “SD”, and [SD Aspect] is set to “4:3”, this item cannot be selected.
 - When [Record Format] → [System] is set to “SD”, and [SD Aspect] is set to “16:9”, “Side Cut” in [A/V Set] → [Video Set] → [SD Aspect] cannot be selected.
- (☞ P160 [System])
(☞ P163 [SD Aspect])

Connecting a Remote Control Unit

The switch functions of the camera recorder can be configured using the remote control unit.

- * Remote control units supported: RM-LP25U, RM-LP55U, RM-LP20G

■ Attaching Core Filter Beforehand **CHE**

Before using the remote control unit, attach the core filter (small) to the remote cable of the remote control unit.

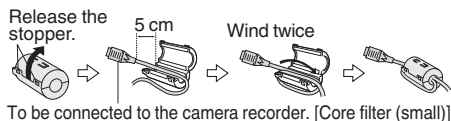

1 Connect the remote control unit to the camera recorder.

Connect the remote cable of the remote control unit to the [REMOTE] terminal.

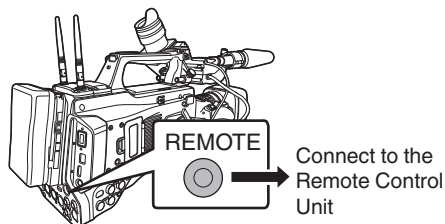

Caution : _____

- Turn off the power of the camera recorder when connecting a remote control unit.

2 Turn on the power of the camera recorder.

3 Set the operate switch of the remote control unit to ON.

Precautions on Using the Remote Control Unit

- When the switches of the camera recorder and remote control unit are operated at the same time, the switch operation of the remote control unit takes priority over that of the camera recorder.
- Focus and zoom operations cannot be performed using the remote control unit.
- The shutter speed may vary slightly from the value displayed on the camera recorder.
- While the camera recorder is in the Media mode, the Auto White Balance feature does not function even if you operate it from the remote control unit.

Connecting the Headphone

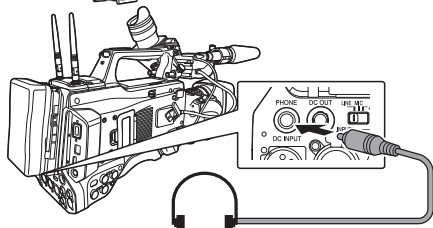
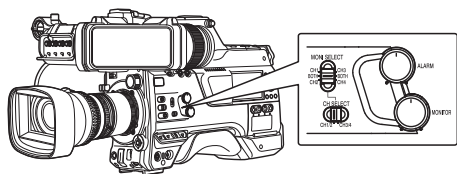

- Audio output from the [PHONE] terminal can be selected using [A/V Set] → [Audio Set] → [PHONE Output] and the combination of the [MONI SELECT] and [CH SELECT] switches. (P141 [PHONE Output])
- The outputs from the [PHONE] terminal and monitor speaker are as follows according to the different combinations of settings.

[MONI SELECT] Switch Setting	[PHONE Output] Setting	[PHONE] Terminal		Speaker
		L	R	
[CH1/CH3]	-	CH1		CH1
[BOTH]	Mix	CH1+CH2		CH1+CH2
	Stereo	CH1	CH2	
[CH2/CH4]	-	CH2		CH2

- 1 Connect the headphone.
- 2 Select the channels to monitor using the different combinations of the [MONI SELECT] and [CH SELECT] switches.

Combinations of [MONI SELECT] and [CH SELECT] Switches	Channels to Monitor	Description
	CH1	The audio input to [CH1] is output.
	CH2	The audio input to [CH2] is output.
	CH1/CH2	The audio inputs to [CH1] and [CH2] are output.
	CH3	The audio input to [CH3] is output.
	CH4	The audio input to [CH4] is output.
	CH3/CH4	The audio inputs to [CH3] and [CH4] are output.

- 3 Use the [MONITOR] adjustment knob to adjust the monitor volume.

Memo : _____

- There is no sound output from the speaker when the headphone is connected.

Inputting External Synchronizing Signals (Genlock)

- A [GENLOCK] terminal is available on the side of the camera recorder.
- You can input synchronizing signals from FS-790 (sold separately) or FS-900 (sold separately) that is connected to the accessory connection terminal (68 pins) on the rear of the camera recorder.
- SDI signals (digital signals) can be input from the [HD/SD SDI IN] terminal.
- Input external synchronizing signals from the [GENLOCK] terminal and [HD/SD SDI IN] terminal, and synchronize the camera video with the external signal.
- Input external synchronizing signals from the [GENLOCK] terminal, and synchronize the camera video with the external signal.
- The H (Horizontal) Phase of the camera recorder's video signals can be adjusted with respect to the external synchronizing signals on the [A/V Set] → [Video Set] → [Genlock Adjust] screen.
(☞ P138 [Genlock Adjust...])

Memo : _____

- The genlock feature is only usable in the Camera mode.

Genlock Signal Settings

For analog signal input

- Synchronizing signal used
- SD synchronizing : BB (Black Burst) signal
Supports SMPTE170M (RS-170A)-NTSC
Supports ITU-R BT.470-6 PAL
- HD synchronizing : HDTV tri-level synchronizing signal
Supports SMPTE ST296-HD720p
Supports SMPTE ST274-HD1080i

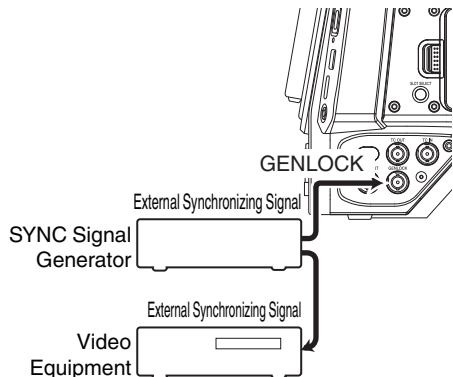

- 1 Set the camera recorder to the Camera mode.
(☞ P20 [Operation Modes])
- 2 Set [Genlock Input] to "GENLOCK".
Set [A/V Set] → [Video Set] → [Genlock Input] to "GENLOCK".
(☞ P138 [Genlock Input])

Memo : _____

- Set to "Adapter" to input synchronizing signal from the accessory connection terminal (68 pins) on the rear of this unit.

- 3 When in the standby or stop mode, input synchronizing signals from the SYNC signal generator to the [GENLOCK] terminal.
 - When the camera recorder's video is locking to the external synchronizing signal, "Sync Locking" appears on the screen.
 - After locking to the external synchronizing signal is complete, the display disappears and recording can be performed.
 - If there is genlock signal input but the signal format is not supported, "Invalid Sync" is displayed.

Memo : _____

- If the frame rate in [A]Frame & Bit Rate/[B]Frame & Bit Rate in the [Record Format] menu is set to "60p", "60i" or "30p", 59.94 Hz synchronizing signals (vertical synchronization) are input.
50 Hz/60 Hz synchronizing signals are not synchronized.
- If the frame rate of [A]Frame & Bit Rate/[B]Frame & Bit Rate in the [Record Format] menu is set to "50p", "50i", or "25p", 50 Hz synchronizing signals (vertical synchronization) are input.
59.94 Hz/60 Hz synchronizing signals are not synchronized.
(☞ P161 [A]Frame Rate/ [EXT] Frame Rate)
- Do not connect or disconnect the input cable for the synchronizing signals during recording or playback
- If the power is turned on during input of external synchronizing signals, vertical oscillation may occur. This is not a malfunction.
- Signals such as VTR playback signals with jitters may not be synchronized on this camera recorder.
- Only H (Horizontal) and V (Vertical) genlock functions are available on this camera recorder. It does not come with a lock function for SC (sub-carrier). Color flash may occur during switching such as when composite signals are used by a switcher.

■ Phase Items to Synchronize

The phase items to be synchronized may vary depending on the input synchronizing signal and output video signal.

Output Video Signal		Input Synchronizing Signal		
		BB	Tri-sync	
			720p	1080i
VIDEO	Composite	H, V, F	V	V, F
SDI	SD-SDI	H, V, F	V	V, F
	HD-SDI 720p	V	H, V	V
	HD-SDI 1080i	V, F	V	H, V, F

H : Horizontal Phase

V : Vertical Phase

F : Field Phase

For digital signals (SDI) input

Input external synchronizing signals from the [HD/SD SDI IN] terminal, and synchronize the camera video or playback image with the external signal.

Input external synchronizing signals from the [HD/SD SDI IN] terminal, and synchronize the camera video with the external signal.

■ Synchronizing signal used

SD synchronizing : Supports SMPTE259M signal

HD synchronizing : Supports SMPTE ST296 signal

3G-SDI : Supports SMPTE ST424 synchronizing signal

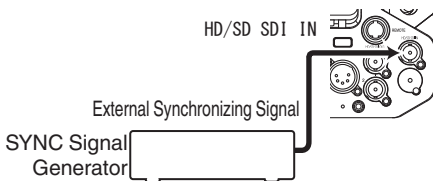

1 Set the camera recorder to the Camera mode.

(☞ P20 [Operation Modes])

2 Set [Genlock Input] to “SDI IN”.

Set [A/V Set] → [Video Set] → [Genlock Input] to “SDI IN”.

(☞ P138 [Genlock Input])

Memo :

- Set to “Adapter” to input synchronizing signal from the accessory connection terminal (68 pins) on the rear of this unit.

3 When in the standby or stop mode, input synchronizing signals from the SDI signal generator to the [HD/SD SDI IN] terminal.

- When the camera recorder’s video is locking to the external synchronizing signal, “Sync Locking” appears on the screen.
- After locking to the external synchronizing signal is complete, the display disappears and recording can be performed.
- If there is genlock signal input but the signal format is not supported, “Invalid Sync” is displayed.

Memo :

- If the frame rate in [A]Frame & Bit Rate/[B]Frame & Bit Rate] in the [Record Format] menu is set to “60p”, “60i” or “30p”, 59.94 Hz synchronizing signals (vertical synchronization) are input. 50 Hz/60 Hz synchronizing signals are not synchronized.
- If the frame rate of [A]Frame & Bit Rate/[B]Frame & Bit Rate] in the [Record Format] menu is set to “50p”, “50i”, or “25p”, 50 Hz synchronizing signals (vertical synchronization) are input. 59.94 Hz/60 Hz synchronizing signals are not synchronized. (☞ P161 [A]Frame Rate/ [EXT] Frame Rate])
- Do not connect or disconnect the input cable for the synchronizing signals during recording or playback
- If the power is turned on during input of external synchronizing signals, vertical oscillation may occur. This is not a malfunction.
- Signals such as VTR playback signals with jitters may not be synchronized on this camera recorder.
- Only H (Horizontal) and V (Vertical) genlock functions are available on this camera recorder. It does not come with a lock function for SC (sub-carrier). Color flash may occur during switching such as when composite signals are used by a switcher.

■ Phase Items to Synchronize

The phase items to be synchronized may vary depending on the input synchronizing signal and output video signal.

Output Video Signal		Input Synchronizing Signal			
		3G-SDI	HD-SDI		SD-SDI
			720p	1080i	
VIDEO	Composite	V	V	V, F	H, V, F
SDI	SD-SDI	V	V	V, F	H, V, F
	HD-SDI 720p	V	H, V	V	V
	HD-SDI 1080i	V	V	H, V, F	V, F
	3G-SDI 1080p	H, V	-	-	-

| Adjusting H Phase

1 Select [Genlock Adjust] in the [A/V Set] menu.

Adjust the [A/V Set] → [Video Set] → Genlock Adjust item as follows.

(☞ P138 [Genlock Adjust...])

- [SD-SDI H Phase] : Adjusts the H Phase of the SD SDI signal.
 [HD-SDI H Phase] : Adjusts the H Phase of the HD SDI signal.

2 Select a value using the cross-shaped buttons (▲▼).

- The H Phase of the camera recorder's video signal is adjusted with respect to the external synchronizing signal input from the [GENLOCK] terminal.

Memo : _____

- Adjustment cannot be made while recording or playback is in progress.
- The video image may be disrupted momentarily during adjustment. This is not a malfunction.

Displaying Return Videos from an External Device

Return video from an external device (switcher, etc.) can be displayed on the viewfinder or LCD monitor of the camera recorder.

Memo : _____

- This feature is only usable in the Camera mode.

1 Set the camera recorder to the Camera mode.

(☞ P20 [Operation Modes])

2 Assign the "Return Video" function to any of the user buttons.

(☞ P45 [Assignment of Functions to User Buttons])

3 Configure the input destination of the return video to "SDI".

To specify the input destination of the return video, configure [A/V Set] → [Video Set] → [Return Input] to "SDI".

(☞ P138 [Return Input])

Memo : _____

- When [System] → [Record Set] → [Record Format] → [System] is configured to "HD(SDI In)" or "SD(SDI In)", "---" is displayed and the setting cannot be configured.

4 Select the aspect ratio of the return video.

Set using [A/V Set] → [Video Set] → [Return Aspect].

(☞ P138 [Return Aspect])

5 Select the way the return video is to be displayed.

Select in [Camera Function] → [User Switch Set] → [Return Video]. The camera will operate according to the setting.

(☞ P116 [Return Video])

6 Press the user button that is assigned with the "Return Video" function.

- By pressing the user button assigned with the "Return Video" function, the captured image or return video is displayed according to the method specified in step 5.

Memo : _____

- Compatible input formats for the return video are as follows.
 - 1920x1080/60p, 60i, 50p, 50i
 - 1280x720/60p, 50p
 - 720x480/60i (U model)
 - 720x576/50i (E model)

Functions of Network Connection

The network feature comprises web-browser-based functions using devices such as a smartphone, tablet terminal, or PC, as well as FTP and live streaming functions that run via thumbnail screens and menu operation.

Memo : _____

- When [System] → [Record Set] → [Record Format] → [System] is set to “High-Speed”, only “Planning Metadata” can be used for the [LAN] terminal connection.

Connecting to the Network

- [LAN] Terminal
 - Built-in Wireless LAN **CHU CHE**
 - Connect the following adapters to the [HOST] terminal (USB)
 - Wireless LAN adapter
 - Ethernet adapter
 - Cellular adapter
- (☞ P195 [Camera Setup for Network Connection])

List of Functions

Importing Metadata

You can download a metadata settings file (XML format) from the FTP server and store metadata in the camera recorder.

(☞ P198 [Importing Metadata])

Uploading Recorded Clips

You can upload clips recorded in the SD card to a preset FTP server.

(☞ P200 [Uploading a Recorded Video Clip])

Memo : _____

- Uploading can also be performed via a web browser.
- (☞ P209 [Uploading a Recording Clip via a Web Browser])

Editing Metadata

- Planning Metadata
You can access the page for editing the camera recorder’s metadata via a web browser on devices such as a smartphone, tablet terminal, or PC, and edit the metadata that is to be applied to clips to be recorded.
(☞ P205 [Planning Metadata])
- Clip Metadata
You can access the page for editing the metadata via a web browser on devices such as a smartphone, tablet terminal, or PC, and display or rewrite the metadata that is recorded to a clip.
(☞ P206 [Clip Metadata])

View Remote

You can access via a web browser on devices such as a smartphone, tablet terminal, or PC to check the live image or remotely control the camera.

(☞ P212 [View Remote Control and Camera Control Functions])

Camera Control

You can access via a web browser on devices such as a smartphone, tablet terminal, or PC to remotely control the camera.

(☞ P212 [View Remote Control and Camera Control Functions])

Live streaming

By combining with the decoder or PC application that supports live streaming, you can perform audio and video streaming via the network.

(☞ P220 [Performing Live Streaming])

Broadcast Overlay

Texts, images and watermark can be overlaid onto recorded video and live stream video. In addition, changes such as changing the image are possible with the SDP Generator app.

Preparing Network Connection

Operating Environment

Operation has been verified for the following environments.

Computer

- OS: Windows 10
Web browser: Chrome
- OS: macOS 10.13
Web browser: Safari 10

Smartphone/Tablet Terminal

- OS: iOS11 (iPhone X/iPad Pro)
Web browser: Safari 11
- OS: Android 6 (Smartphone)
Web browser: Chrome
- OS: Android 7 (Tablet)
Web browser: Chrome

Camera Setup for Network Connection

1 Connect using the corresponding method of connection

- [LAN] Terminal
Connect a PC to this camera recorder directly using a cross-over cable or via devices such as an Ethernet hub using a LAN cable.

(☞ P195 [Connecting to Network via [LAN] Terminal])

- Built-in Wireless LAN [CHU CHE]
Attach the wireless LAN antenna if it is not mounted.

(☞ P32 [Attaching the Wireless LAN Antennas (Supplied) [CHU CHE]])

(☞ P197 [Connecting to Network via Built-in Wireless LAN [CHU CHE]])

- Connect the following adapters to the [HOST] terminal (USB)
 - Wireless LAN adapter
 - Ethernet adapter
 - Cellular adapter

(☞ P196 [Connecting to Network via [HOST] Terminal (USB)])

Memo : _____

- Only a network connection adapter can be connected to the [HOST] terminal (USB).
- Connect or disconnect an adapter only after you have turned off the power of the camera recorder.
- You can find the latest information on the compatible adapters at the product page of our website.
- Two types of network coverage (WAN and LAN) are available for each application.

Caution : _____

- When [System] → [Record Set] → [Record Format] → [System] is configured to “High-Speed”, network cannot be used via wireless LAN [CHU CHE] or the [HOST] terminal (USB). Configure as follows in this case.
 - Set [Network] → [Connection Setup] → [USB/Int. WLAN] to “Off”. [CHU CHE]
 - Unplug the USB network adapterNote that camera operation will come to an emergency stop and the power will turn off if the above steps are not performed. File data may be damaged if this happens while recording is in progress.

Connecting to Network via [LAN] Terminal

You can connect a device such as a smartphone, tablet terminal, or PC directly to the camera recorder using a cross cable to access the camera recorder’s web functions. Alternatively, you can also connect using an Ethernet hub.

1 Configure the connection settings with [Wizard].

- Select “LAN” in [Network] → [Connection Setup] → [Wizard], and configure the settings according to the instructions on the screen. Perform setting for the following.
 - IP address setting (DHCP or manual)
 - IP Address
 - Subnet mask
 - Default gateway
 - DNS Server

Memo : _____

- When an address is manually assigned in a NAT environment, it is also necessary to set the default gateway correctly besides conversion of the address at the router’s end in order to perform operations such as access to the Internet from an external network via the router.

2 Setting is complete.

After setting is complete, you can access the camera recorder via a web browser.

Memo : _____

- After setting is complete, the following items will be automatically configured.
 - The [Network] → [Connection Setup] → [Default Gateway] setting changes to “LAN”.
 - The [Network] → [Live Streaming] → [Interface] setting changes to “LAN”.

Connecting to Network via [HOST] Terminal (USB)

1 Configure the connection settings with [Wizard].

- Select “USB” in [Network] → [Connection Setup] → [Wizard], and configure the settings according to the instructions on the screen.

Configure the settings for the following according to the type of connection.

- USB wireless LAN connection
 - Mode of connection
 - Configuration method
- * For P2P connections, it is necessary to configure the [Default Gateway] and [Passphrase] according to the steps below after the above settings are configured.

① Configure [Network] → [Connection Setup] → [Default Gateway] to “USB/Int. WLAN” **CHU CHE** or “USB” **STU RCHE**

② Set the camera recorder to the Camera mode, and display the status screen ([USB/Int. WLAN] screen **CHU CHE** or [USB] screen **STU RCHE**).

- Press the [STATUS/SET] button on the camera recorder to display the status screen.

Press the cross-shaped button (◀▶) to display the [USB/Int. WLAN] screen **CHU CHE** or [USB] screen **STU RCHE**.

- Check to ensure that the [SSID] and [Passphrase] that you have set in the wizard are displayed.

③ Select an SSID from the list of access points (smartphone, tablet terminal, PC, etc.) and enter a passphrase.

- Display the list of access points in the wireless connection settings of the smartphone, tablet terminal, or PC, and select “HC900-****”. (**** are numbers that vary with the device used.)
- After the password confirmation screen appears, enter the [Passphrase] displayed on the [USB/Int. WLAN] screen **CHU CHE** or [USB] screen **STU RCHE**.

- USB wired LAN connection
 - IP address setting (DHCP or manual)
 - IP Address
 - Subnet mask
 - Default gateway
 - DNS Server

Memo : _____

- When an address is manually assigned in a NAT environment, it is also necessary to set the default gateway correctly besides conversion of the address at the router’s end in order to perform operations such as access to the Internet from an external network via the router.

- USB cellular adapter connection
 - Connection phone number
 - Username
 - Password

Caution : _____

- You can access the web functions via a web browser on devices such as a smartphone, tablet terminal, or PC only in a LAN environment.
- Note that you may have to pay very high bills in the case of pay-per-use contracts. Fixed price contract is recommended if you are using the network function.
- Note that the use of improper settings may result in expensive bills from the phone service provider. Make sure that the setting is correct.
- To avoid expensive bills due to the roaming connection, you are recommended to use this function by disabling the roaming contract.
- There may be communication even when you are not using the network function. Remove the cellular adapter when the function is not in use.

2 Setting is complete.

After setting is complete, you can access the camera recorder via a web browser.

Memo : _____

- After setting is complete, the following items will be automatically configured.
 - The [Network] → [Connection Setup] → [USB/Int. WLAN] setting changes to “On”. **CHU CHE**
 - The setting of [Network] → [Connection Setup] → [Default Gateway] changes to “USB/Int. WLAN” **CHU CHE** or “USB” **STU RCHE**. However, this does not apply to the P2P connection.
 - The setting of [Network] → [Live Streaming] → [Interface] changes to “USB/Int. WLAN” **CHU CHE** or “USB” **STU RCHE**.

Connecting to Network via Built-in Wireless LAN **CHU** **CHE**

1 Configure the connection settings with [Wizard].

- Select “USB/Int. WLAN” in [Network] → [Connection Setup] → [Wizard], and configure the settings according to the instructions on the screen.
Perform setting for the following.
 - Mode of connection
 - Configuration method
- * For P2P connections, it is necessary to configure the [Default Gateway] and [Passphrase] according to the steps below after the above settings are configured.

- ① Set [Network] → [Connection Setup] → [Default Gateway] to “USB/Int. WLAN”.
- ② Set the camera recorder to the Camera mode, and display the [USB/Int. WLAN] (status) screen.
 - Press the [STATUS/SET] button on the camera recorder to display the status screen. Press the cross-shaped button (◀▶) to display the [USB/Int. WLAN] screen.
 - Check to ensure that the [SSID] and [Passphrase] that you have set in the wizard are displayed.
- ③ Select an SSID from the list of access points (smartphone, tablet terminal, PC, etc.) and enter a passphrase.
 - Display the list of access points in the wireless connection settings of the smartphone, tablet terminal, or PC, and select “HC900-****”. (**** are numbers that vary with the device used.)
 - After the password confirmation screen appears, enter the [Passphrase] displayed on the [USB/Int. WLAN] screen.

2 Setting is complete.

After setting is complete, you can access the camera recorder via a web browser.

Memo : _____

- After setting is complete, the following items will be automatically configured.
 - The [Network] → [Connection Setup] → [USB/Int. WLAN] setting changes to “On”.
 - The [Network] → [Connection Setup] → [Default Gateway] setting changes to “USB/Int. WLAN”. However, this does not apply to the P2P connection.
 - The [Network] → [Live Streaming] → [Interface] setting changes to “USB/Int. WLAN”.

Importing Metadata

You can download a metadata settings file (XML format) from the FTP server and store metadata in the camera recorder.

The imported metadata is applied to clips to be recorded.

Preparing Metadata

- You can record the four metadata types below.

Title1 : ASCII only, max. 63 characters (bytes)

Title2 : UNICODE, max. 127 bytes

Creator : UNICODE, max. 127 bytes

Description : UNICODE, max. 2047 bytes

- Metadata makes use of the XML description format.
- Edit the <Title1><Title2><Description><Creator> tag element using the XML editor. (Indicated by the frames below)

```
<?xml version="1.0" encoding="UTF-8"?>
<NRT-MetaInterface lastUpdate="2015-01-29T18:06:21+09:00"
xmlns="urn:schemas-proHD:nonRealTimeMetaInterface.ver.1.00"
xmlns:xsi="http://www.w3.org/2001/XMLSchema-instance">
  <MetaData>
    <Title1>Title1 sample</Title1>
    <!-- only "en",max63bytes -->
    <Title2>Title2 sample</Title2>
    <!-- ,max127bytes -->
    <Description>Description sample</Description>
    <!-- ,max2047bytes -->
    <Creator>Creator sample</Creator>
    <!-- ,max127bytes -->
  </MetaData>
</NRT-MetaInterface>
```

Configuring the Server for Downloading

For specifying the settings for connecting to the FTP server for downloading the metadata (domain name, user name, password, etc.) as well as the path of the file to download.

- Open the [Metadata Server] screen.
Open the [Network] → [Metadata Server] screen.

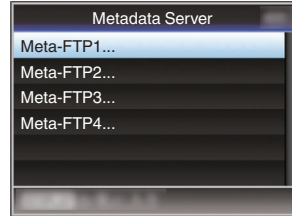

- Register the [Metadata Server].

- Select a server using the cross-shaped button (▲▼), and press the Set button (●). The server settings screen appears. Perform setting for each item.
- Up to 4 settings can be registered. (P143 [Metadata Server])

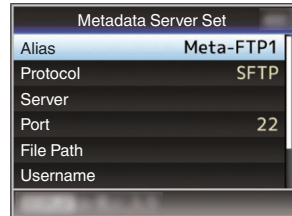

Memo : _____

- For details on the registered information, please consult the network administrator for the server.

Importing Metadata

Download the metadata settings file (XML format) from the FTP server.

1 Select [Network] → [Import Metadata] and press the Set button (●).

The [Import Metadata] screen appears.

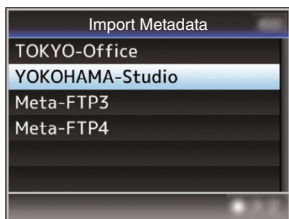

2 Select the server for importing the metadata.

- The name that is registered in [Metadata Server] → [Alias] is displayed.
- Select a server using the cross-shaped button (▲▼), and press the Set button (●).

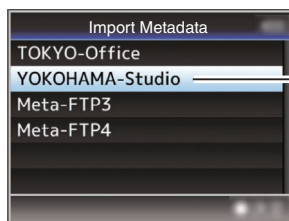

3 Select [Import] on the confirmation screen, and press the Set button (●).

Import starts.

After import is complete, the display is restored to the screen before the [Import Metadata] screen appears.

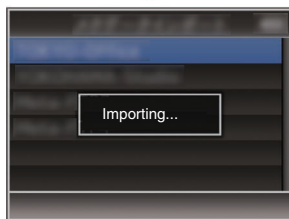

Memo :

- You cannot exit the menu or perform recording while import is in progress.
- If import of the metadata failed, "Import Error!" is displayed, and a message indicating the cause of the error appears.
Press the Set button (●) to return to the [Import Metadata] screen in step 1.
- (P239 [List of FTP Transfer Errors])
- When "HTTP" is selected in the [Select FTP Proxy] screen of the network connection setting, connections to the servers other than "FTP" protocol cannot be made.
- If a setting other than "FTP" is specified for [Protocol], to ensure the safety of the communication path, a screen appears prompting you to validate the fingerprint of the public key and certificate received from the server.
Check to ensure that the displayed value coincides with the known value.

Uploading a Recorded Video Clip

The following are steps to upload clips recorded in a recording media to a preset FTP server.

Configuring the FTP Server for Uploading

For specifying the settings for connecting to the FTP server to upload recorded clips to (domain name, user name, password, etc.) as well as the directory of the upload destination.

1 Open the [Clip Server] screen.

Open the [Network] → [Upload Settings] → [Clip Server] screen.

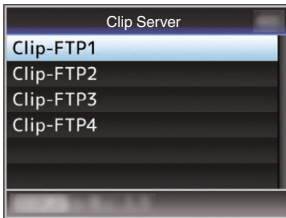

2 Register the [Clip Server].

Register the server to upload recorded clips in the recording media to.

Up to 4 servers can be registered.
(P154 [Clip Server])

Memo : _____

- For details on the registered information, please consult the network administrator for the server.

Uploading Clips Automatically (Auto FTP)

The following are steps to automatically upload clips recorded in a recording media to a preset FTP server.

1 Configure the settings for automatic upload.

Configure [Network] → [Upload Settings] → [Upload] to “Auto” and configure the settings for each of [Slot], [Cellular] and [Server].
(P153 [Upload])

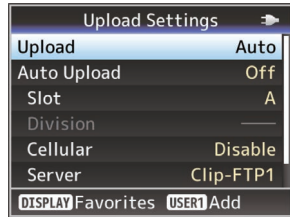

2 Start uploading.

- Configuring [Network] → [Upload Settings] → [Auto Upload] to “On” starts uploading.
- You can also press the user button that is assigned with “Auto Upload”.

Memo : _____

- FTP transfer is performed for the slot configured in [Slot].
- If recording is started for the same slot as the one configured in [Slot] while FTP transfer is in progress, FTP transfer will be interrupted.
- FTP transfer is not performed while live streaming or Return over IP is in progress.
- FTP transfer is disabled when [System] → [Record Set] → [Record Format] → [System] is configured to “High-Speed”. To perform FTP transfer, select a setting other than “High-Speed”.
- While automatic upload is in progress, you can view the FTP transfer status on the Status screen.
- To play back a recorded clip while automatic upload is in progress, you can do so by switching to Media mode, followed by pausing the upload and selecting the clip to play back from the thumbnail display. Switching to Camera mode resumes automatic upload in the background.

Automatic Chunked Upload to FTP Server

Automatically splits the clips and uploads them to the FTP server during recording at the preconfigured time for proxy recording in Slot B when [System] is configured to "HD+Web".

1 Configure the time to split the clips for automatic chunked upload

Configure the time in [Network] → [Upload Settings] → [Auto Upload] → [Division] for starting automatic upload while recording is in progress.

Memo : _____

- [Slot] is fixed at "B".
-

Uploading Clips Manually (Manual FTP)

The following are steps to upload clips recorded in a recording media to a preset FTP server. All playable clips on the thumbnail screen can be uploaded.

1 Configure the FTP server for manual uploading.

Set [Network] → [Upload Settings] → [Upload] to "Manual".

(☞ P153 [Upload])

2 Register the [Clip Server].

- Open the [Network] → [Upload Settings] → [Clip Server] screen.
- Register the server to upload recorded clips in the recording media to.
Up to 4 servers can be registered.

(☞ P154 [Clip Server])

Memo : _____

- For details on the registered information, please consult the network administrator for the server.
 - When [Network] → [Upload Settings] → [Upload] is configured to "Auto", manual uploading is also disabled for slots other than the selected "Slot". To perform manual uploading, select "Manual".
 - FTP transfer is disabled when [System] → [Record Set] → [Record Format] → [System] is configured to "High-Speed". To perform FTP transfer, select a setting other than "High-Speed".
-

Uploading a Video Clip

1 Set the camera recorder to the Media mode.

- Press and hold the [CAM/MEDIA] selection button in the Camera mode to enter the Media mode. A thumbnail screen of the clips recorded on the SD card is displayed.
- You can upload the selected clips on the thumbnail screen to the FTP server.

(☞ P97 [Thumbnail Screen])

- 2 Move the cursor to the clip to be uploaded.**
Move the cursor to the clip to be uploaded using the cross-shaped button (▲▼◀▶).



- 3 Press the [USER4] button.**
The action selection screen is displayed.

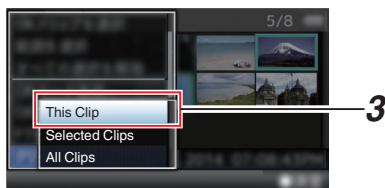

- 4 Select [FTP Upload] → [This Clip] → server to upload to, and press the Set button (●).**
The status of the transfer process is indicated by a progress bar.

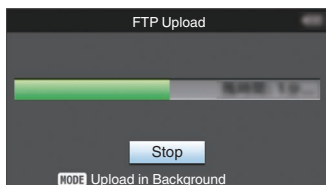

Memo : _____

- The name for the server to upload files to are indicated using the preset names in [Clip Server] → [Alias].
- To stop uploading, press the Set button (●). Select [Yes] on the confirmation screen, and press the Set button (●) to stop uploading and return to the thumbnail screen.

- 5 Upload is complete.**
- After upload is complete, “Successfully Completed.” appears on the screen.
 - Press the Set button (●) to return to the thumbnail screen.



Selecting and Uploading Multiple Clips

To select and upload multiple clips, refer to “[Selecting and Performing Operations on Multiple Clips] (P 104)”.

Uploading All Video Clips

- 1 Press the [USER4] button.**
The action selection screen is displayed.
- 2 Upload the clips.**
Select [FTP Upload...] → [All Clips] → server to upload to, and press the Set button (●).



- 3 Upload starts.**
The status of the transfer process is indicated by a progress bar.

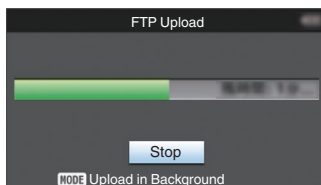

Memo : _____

- To stop uploading, press the Set button (●). Select [Yes] on the confirmation screen, and press the Set button (●) to stop uploading and return to the thumbnail screen.
 - If the file to be uploaded has the same name as an existing file in the FTP server, an overwrite confirmation window appears.
 - When “HTTP” is selected in the [Select FTP Proxy] screen of the network connection setting, the overwrite confirmation window will not be displayed and the existing file is overwritten.
 - Even after upload has started (FTP transfer in progress) in step 3, pressing the [CAM/MEDIA] button switches the camera recorder to the Camera mode, allowing you to start shooting.
 - If a setting other than “FTP” is specified for [Protocol], to ensure the safety of the communication path, a screen appears prompting you to validate the fingerprint of the public key and certificate received from the server.
Check to ensure that the displayed value coincides with the known value.
 - Fingerprint is a unique value that varies with each public key and certificate.
 - For details of the fingerprint, please consult the administrator of the server to be connected.
- (☞ P154 [Clip Server])
- When “HTTP” is selected in the [Select FTP Proxy] screen of the network connection setting, connections to the servers other than “FTP” protocol cannot be made.

4 Upload is complete.

- After all clips are uploaded successfully, “Successfully Completed.” is displayed. Press the Set button (●) to return to the thumbnail screen.
- When clips are not uploaded successfully, the following errors are displayed.

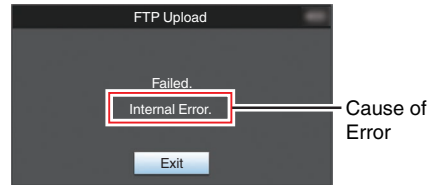

(☞ P239 [List of FTP Transfer Errors])

Memo : _____

- If there is an error message or other notifications when you switched to the Camera mode while FTP upload is in progress, a 🗨 icon (yellow) will appear in the remaining media space display area in the Camera mode.
You can press the [CAM/MEDIA] button to switch to the Media mode and display the above error screen.
Follow “[List of FTP Transfer Errors] (☞ P 239)” to clear the error message.

FTP Resume Feature

When FTP transfer starts and there is a file of the same name on the server with a file size smaller than the file to be transferred, the file on the server will be regarded as an interrupted file during a FTP transfer. A confirmation screen to resume transfer (append writing) appears.

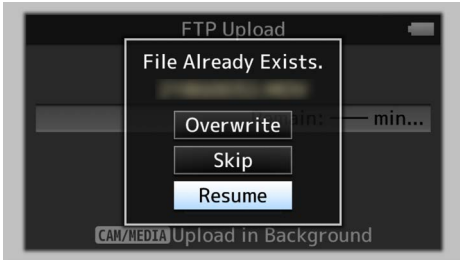

If “Resume” is selected, FTP transfer is carried out such that it appends from the position where it was interrupted. When FTP transfer ends normally, “Complete” appears on the screen.

Memo : _____

- FTP server equipped with resume function is required.
- If [Network] → [Upload Settings] → [Clip Server] → [Clip-FTP1/2/3/4] → [Protocol] is set to “SFTP”, the resume function is disabled.
- If “HTTP” is selected in the [Select FTP Proxy] screen of the network connection setting, the resume function is disabled.

Connecting from a Web Browser

You can access the web functions of this camera recorder via a web browser on devices such as a smartphone, tablet terminal, or PC. Make the necessary preparations for connection in advance.

(☞ P195 [Camera Setup for Network Connection])

1 Set the camera recorder to the Camera mode, and display the status screen ([LAN] or [USB/Int. WLAN] screen [CHU] [CHE] or [USB] screen [STU] [RCH]).

- Press the [STATUS/SET] button on the camera recorder to display the status screen. Press the cross-shaped button (◀▶) to display the [LAN] or [USB/Int. WLAN] screen [CHU] [CHE], or [USB] screen [STU] [RCH].
- Check the displayed [IP Address].

2 Start up the web browser on the terminal you wish to connect to the camera recorder, and enter the [IP Address] in the address field.

(Example: 192.168.0.10)

If “192.168.0.10” is displayed in [IP Address], enter “http://192.168.0.10”.



3 Enter the user name and password.

Enter the user name and the password on the login screen to display the main page of the camera.

- Check the [Web Username] and [Web Password] in the [Network] screen (status screen).

Memo : _____

- The user name and password can be changed in [Network] → [Web] → [Username] and [Password].
(☞ P152 [Username])
(☞ P152 [Password])

Editing Metadata

You can create the metadata to be inserted into a recorded file, or rewrite the metadata of a recorded clip.

Planning Metadata

You can access the page for editing the camera recorder's metadata via a web browser on devices such as a smartphone, tablet terminal, or PC, and edit the metadata that is to be applied to clips to be recorded.

1 Access the main page of the camera.

Access the page via a web browser on devices such as a smartphone, tablet terminal, or PC. (P204 [Connecting from a Web Browser])

2 Tap (click) the [Planning Metadata] tab to open the [Planning Metadata] screen.



3 Edit the metadata.

- ① Enter information for the necessary fields.
- ② After input is complete, tap (click) [Save] to overwrite the metadata.

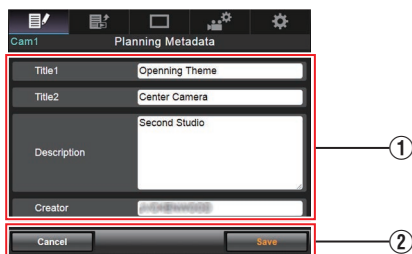

4 Tap (click) [OK] on the confirmation screen.

- Update of the [Planning Metadata] starts.
- After update is complete, "Renewal of planning metadata is succeeded." is displayed. Tap (click) [OK].
- Returns to the screen in step 3.

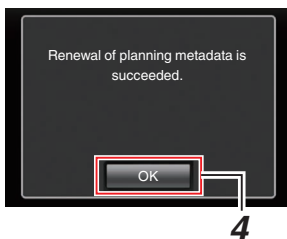

Memo : _____

- If update failed, "Renewal of planning metadata is failed." is displayed. Tap (click) [Close] to return to the screen of step 3.

Clip Metadata

You can access the page for editing the metadata via a web browser on devices such as a smartphone, tablet terminal, or PC, and display or rewrite the metadata that is recorded to a clip.

1 Access the main page of the camera.

Access the page via a web browser on devices such as a smartphone, tablet terminal, or PC. (P204 [Connecting from a Web Browser])

2 Display the clip list.

Tap (click) the [Clip List] tab to display the clip list.

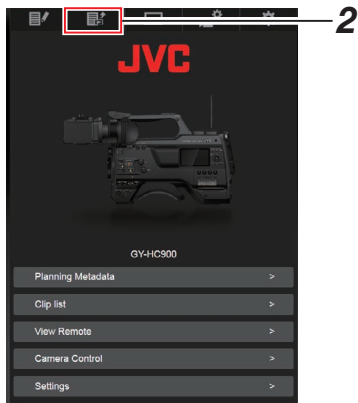

Switching from a web browser

- ① You will see a message indicating "It is necessary to change the camera mode to "Remote Edit Mode". Change the mode." on the web browser.

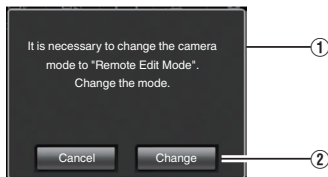

- ② Tap (click) [Change] to switch the camera to the Remote Edit mode.

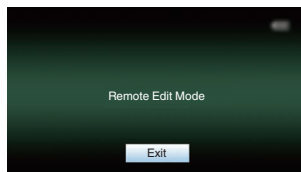

Switching from the camera

- ① "Change to Remote Edit Mode?" is displayed on the display screen of the camera unit.
- ② Select [Change] and press the Set button (●) to switch to the Remote Edit mode.

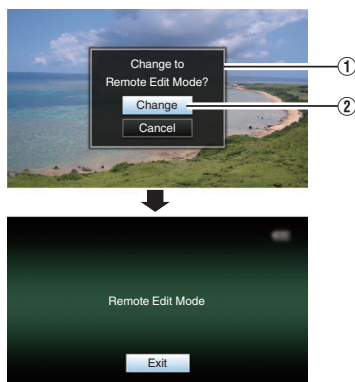

Memo : _____

- When the menu or status is displayed, display of the confirmation screen will be put on hold.
- If the menu is displayed on the camera recorder, close the menu.
- If the status is displayed on the camera recorder, close the status display.
- Pressing the Set button (●) on the camera recorder while in the Remote Edit Mode ends the Remote Edit Mode forcibly and switches to the Camera mode.
- When FTP upload via the camera unit is currently in progress, switching to the Remote Edit mode is disabled.

4 Select the Metadata Edit mode.

Select the [Metadata] tab.

5 Select the clip to rewrite the metadata.

- A list of the recorded clips appears on the [Clip List] screen.
- Tap (click) the clip for which you want to rewrite the metadata.

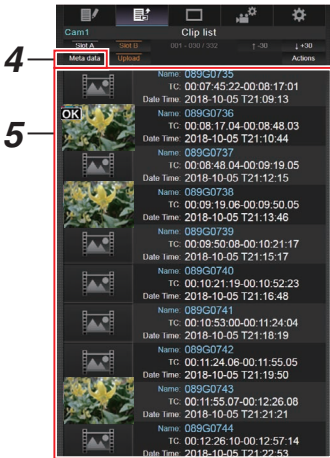

6 Edit the metadata of the selected clips.

- ① Edit the information for the necessary fields.
 - If you are using a PC, input using the mouse and keyboard.
 - If you are using a smartphone or tablet terminal, tap the text input area to display a standard software keyboard on the screen. Enter the information using the displayed keyboard.
- ② You can tap (click) [OK Mark] to add an OK mark to or delete it from selected clips.
- ③ After editing is complete, tap (click) [Save] to overwrite the metadata.

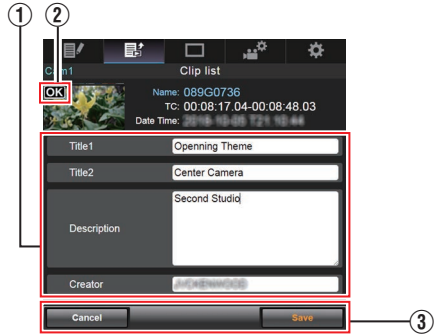

Memo : _____

- You can switch the displayed slot using the [Slot A] and [Slot B] tabs.
- You can use the [▲-30] or [▼+30] tab to jump to the previous or next 30 clips on the list.

- 7 Tap (click) [OK] on the confirmation screen.
- Update of the metadata starts.
 - After update is complete, “Renewal of clip metadata is succeeded.” is displayed. Tap (click) [OK].
 - Returns to the screen in step 4.

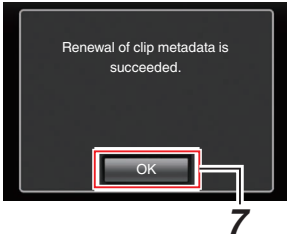

Memo : _____

- If update failed, “Renewal of clip metadata is failed.” is displayed.
Tap (click) [Close] to return to the screen of step 4.
- _____

Uploading a Recording Clip via a Web Browser

- Upload clips recorded in the SD card to a preset FTP server.
- You can upload selected clips, all clips, or those appended with an OK mark.

Configuring the FTP Server for Uploading

(P200 [Configuring the FTP Server for Uploading])

Uploading Video Clips

- 1 Access the main page of the camera.**
Access the page via a web browser on devices such as a smartphone, tablet terminal, or PC.
(P204 [Connecting from a Web Browser])
- 2 Display the clip list.**
Tap (click) the [Clip List] tab to display the clip list.



- 3 Set the camera recorder to the "Remote Edit Mode".**
You can switch to "Remote Edit Mode" from a web browser or through operation of the camera.

■ Switching from a web browser

- ① You will see a message indicating "It is necessary to change the camera mode to "Remote Edit Mode". Change the mode." on the web browser.

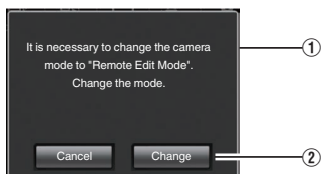

- ② Tap (click) [Change] to switch the camera to the Remote Edit mode.

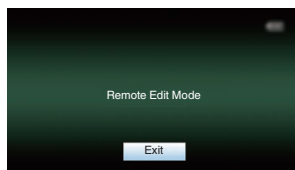

■ Switching from the camera

- ① "Change to Remote Edit Mode?" is displayed on the display screen of the camera unit.
- ② Select [Change] and press the Set button (●) to switch to the Remote Edit mode.

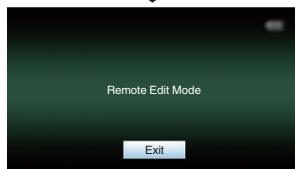
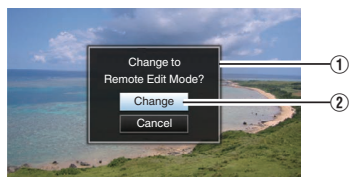

Memo : _____

- When the menu or status is displayed, display of the confirmation screen will be put on hold.
- If the menu is displayed on the camera recorder, close the menu.
- If the status is displayed on the camera recorder, close the status display.
- Pressing the Set button (●) on the camera recorder while in the Remote Edit Mode ends the Remote Edit Mode forcibly and switches to the Camera mode.
- When FTP upload via the camera unit is currently in progress, switching to the Remote Edit mode is disabled.

4 Select the Upload mode.

Select the [Upload] tab.

5 Select the clip you want to upload.

- A list of the recorded clips appears on the [Clip List] screen.
- Tap (click) the clip you want to upload to select it.
- Clips being selected are indicated by a check mark.

Memo : _____

- You can switch the displayed slot using the [Slot A] and [Slot B] tabs.
- You can use the [▲-30] or [▼+30] tab to jump to the previous or next 30 clips on the list.

6 Select the upload operation.

Tap (click) the [Actions] button.

7 Select a method to upload the clips.

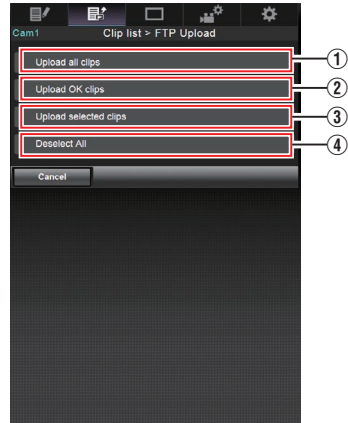

- ① Upload all clips
Uploads all the clips in the displayed slots.
Tap (click) to move to the [Clip Server] screen.
- ② Upload OK clips
Uploads all clips in the displayed slots that are appended with an OK mark.
Tap (click) to move to the [Clip Server] screen.
- ③ Upload selected clips
Uploads the clips you have selected.
Tap (click) to move to the [Clip Server] screen.
- ④ Clear all selection
Clears all clip selection and returns to the [Clip List] screen.

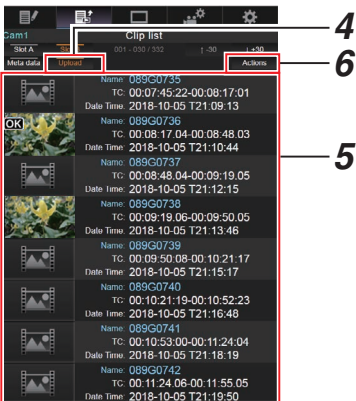

8 Select the clip server and start uploading.

- Upon selecting the server to upload clips to, an upload screen appears.

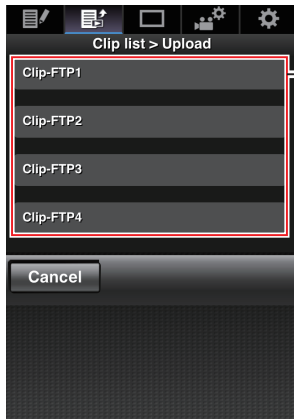

- The status of the transfer process is indicated by a progress bar.

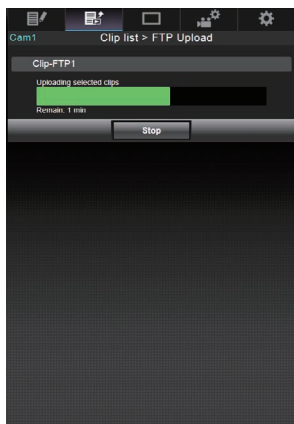

Memo : _____

- To stop transfer, tap (click) the [Stop] button. Tapping (clicking) [Yes] on the confirmation screen stops the transfer halfway and brings you back to the main page.
- If there already exists a file on the FTP server with a name identical to the file to be transferred, a confirmation screen asking to overwrite the file will appear. However, if "HTTP" is selected in the [Select FTP Proxy] screen of the network connection settings, an overwrite confirmation screen does not appear, and the existing file will be overwritten directly.
- After uploading in step 8 has started, other web browser operations are disabled until uploading is complete.
- After uploading in step 8 has started and upon shifting to the Media mode by pressing the [CAM/MEDIA] selection button, operation from the web browser will be disabled. To enable web browser operation, press the [CAM/MEDIA] selection button again to switch to the Camera mode.
- If a setting other than "FTP" is specified for [Protocol], to ensure the safety of the communication path, a screen appears prompting you to validate the fingerprint of the public key and certificate received from the server. Check to ensure that the displayed value coincides with the known value.
 - Fingerprint is a unique value that varies with each public key and certificate.
 - For details of the fingerprint, please consult the administrator of the server to be connected.
(P154 [Clip Server])
- When "HTTP" is selected in the [Select FTP Proxy] screen of the network connection setting, connections to the servers other than "FTP" protocol cannot be made.

9 Upload is complete.

- After upload is complete, "Successfully Completed." appears on the screen.

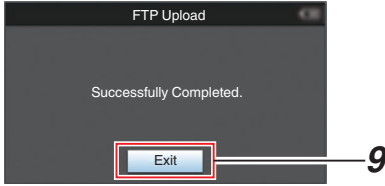

- When clips are not uploaded successfully, the following errors are displayed.

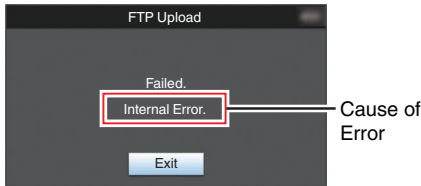

(☞ P239 [List of FTP Transfer Errors])

Memo : _____

- Follow "[List of FTP Transfer Errors] (☞ P 239)" to clear the error message.
- _____

View Remote Control and Camera Control Functions

You can control the camera by accessing via a web browser on devices such as a smartphone, tablet terminal, or PC.

You can perform the following operations for each of the items.

The image is displayed on the View remote.

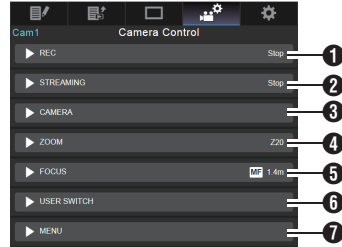

1 REC

For performing recording start or recording pause operation.



2 STREAMING

Turns on or off live streaming.



3 CAMERA

Enables operations related to the camera functions.

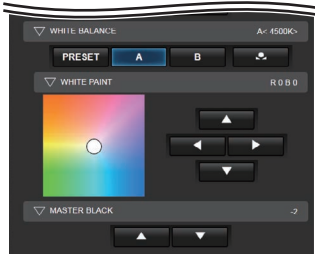
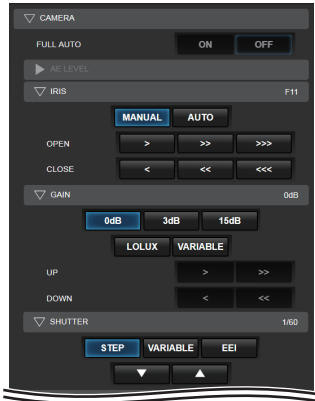

4 ZOOM

Enables zooming operations.



5 FOCUS

Enables focusing operations.



6 USER SWITCH

You can enable or disable the user buttons that are assigned with a function.



7 MENU

You can show or hide the display and menu characters on an external monitor as well as operation of menus, switching the display screen and status display.



Changing the Settings via a Web Browser

You can change the network-related settings by accessing via a web browser on devices such as a smartphone, tablet terminal, or PC.

1 Access the main page of the camera.

Access the page via a web browser on devices such as a smartphone, tablet terminal, or PC. (P204 [Connecting from a Web Browser])

2 Tap (click) the [Settings] tab.



3 The [Settings] screen appears.

Set each of the items as follows.

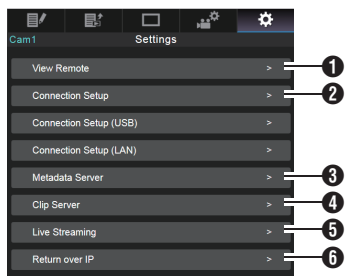

1 View Remote
Settings for operations on the View Remote.

2 Connection Setup
Settings related to the network.
You can change the settings for each of the preset items on the [Wizard] screen of the camera recorder.

3 Metadata Server
Settings on the server for importing the metadata.
Setting can be performed in the same way as the Metadata Server menu on the camera recorder.

The latest settings are reflected, regardless of whether they are specified via the camera recorder or web operation.

4 Clip Server
Settings for the server to upload recorded clips to.
Setting can be performed in the same way as the [Clip Server] menu on the camera recorder. The latest settings are reflected, regardless of whether they are specified via the camera recorder or web operation.

5 Live Streaming
Setting for streaming audio and video via the network.
The latest settings are reflected, regardless of whether they are specified via the camera recorder or web operation.

6 Return over IP
For specifying settings related to Return over IP. For configuring settings for receiving video and audio via the network.
The latest settings are reflected, regardless of whether they are specified via the camera recorder or web operation.

Memo : _____

- Priority is given to menu operation on the camera recorder.
- When the menu on the camera recorder is opened while the [Settings] screen is opened using a web browser, a warning appears, after which the display returns to the main screen.
- While the menu is displayed on the camera recorder, the [Settings] screen cannot be opened via the web browser.

Changing View Remote Function Settings

For performing setting for using the View Remote function.

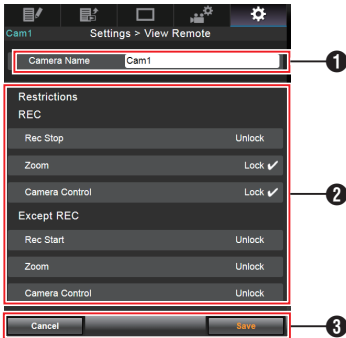

- 1 [Camera Name]
 - For setting the name that appears at the top left of the view screen.
 - Tapping the text input area displays a software keyboard. If you are using a PC, enter using the PC keyboard.
 - By tapping the Go key after input is complete, the software keyboard disappears.
- 2 [Restrictions]

For setting the buttons to be disabled on the View screen while in the locked mode.

 - [REC]:

For setting whether to disable the Stop Record button, zoom operation, and camera control during recording. Tap (click) each item to switch between [Unlock] and [Lock].
 - [Except REC]:

For setting whether to disable the record button, zoom operation, and camera control in any mode other than the recording mode. Tap (click) each item to switch between [Unlock] and [Lock].
- 3 [Save]/[Cancel]

Tap (click) [Save] to save the settings.
Tap (click) [Cancel] to stop setting and return to the main [Settings] screen.

Changing Connection Setup

You can change the settings for each of the preset items on the [Wizard] screen of the camera recorder.

- If all the items cannot be displayed in a single page, scroll down to display the remaining items.
- Items that cannot be changed are grayed out according to the type of adapter connected and the mode of connection.

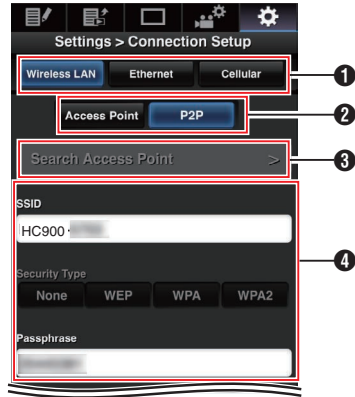

- 1 Type of Adapter Connected
- 2 Mode of Wireless LAN Connection
- 3 [Search Access Point] Button

Tap (click) to display a list of the detected access points. The currently selected access point is indicated by a dot mark (•).

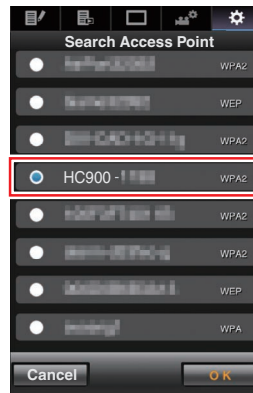

4 Settings on the [Select Setup Type] Screen

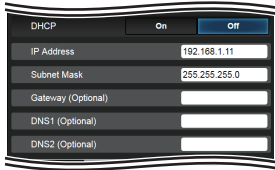

5 Settings on the [IP Address Configuration] Screen

When “DHCP” is selected, all items will be grayed out.

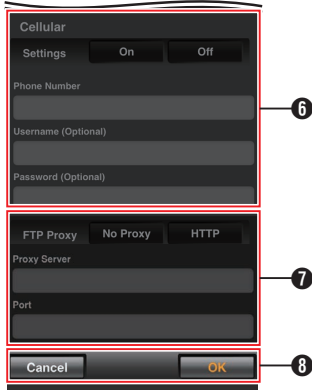

- 6 Settings when using cellular adapter
- 7 Settings on the [Select FTP Proxy] Screen
- 8 [OK]/[Cancel] Button
After changing of settings is complete, tap (click) the [OK] button.
On the confirmation screen, tap (click) [Execute] to change the settings on the camera recorder and restart the network.

Changing Metadata Server Settings

You can make direct changes to the FTP server for importing the metadata set in [Network] → [Metadata Server], as well as the path of the file to import.

(☞ P152 [Metadata Server Item])

Changing Clip Server Settings

You can make direct changes to the server and directory settings that are specified in [Network] → [Clip Server] for uploading recorded clips in the recording media to the FTP server.

(☞ P154 [Clip Server])

Changing Streaming Settings

You can make direct changes to settings that are specified in [Network] → [Live Streaming], such as information on the destination of distribution.

(☞ P145 [Live Streaming Item])

Managing the Network Connection Settings File

This camera recorder allows you to save the network connection settings on the Wizard screen to the camera recorder unit.

Loading a saved connecting settings file enables you to reproduce the appropriate network connection state speedily.

Memo : _____

- To save or retrieve the connection settings, go to [Network] → [Connection Setup].
- The following operations can be performed on the [Connection Setup] menu.
 - [Saving the Connection Settings File] (☞ P 217)
 - [Reading the Connection Settings File] (☞ P 218)
 - [Deleting Connection Settings] (☞ P 219)

Number of Storable Setup Files

Camera recorder : [CAM1] to [CAM4]

[Saving the Connection Settings File

- 1 Select [Network] → [Connection Setup] → [Setup File] [CHU] [CHE] / [USB Setup File] [STU] [RCHE] and press the Set button (●).
- 2 Select [Store] and press the Set button (●).

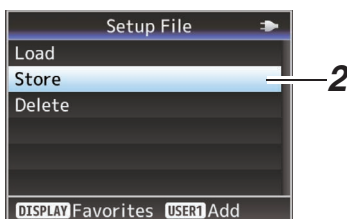

- 3 Select the file to be newly saved (or overwritten) using the cross-shaped button (▲▼), and press the Set button (●).



- 4 Name the file.
Enter the subtitle using the software keyboard.
(☞ P109 [Text Input with Software Keyboard])

Memo : _____

- When overwriting an existing file, the subtitle of the existing file is displayed.
- Select [Cancel] and press the Set button (●), or press the [CANCEL/RESET] button to return to the previous screen.

5 Select [Store] and press the Set button (●).



6 Save the file.

- A confirmation screen appears when you choose to overwrite. Select [Overwrite] on the confirmation screen, and press the Set button (●). Saving starts, and “Storing...” appears on the screen.

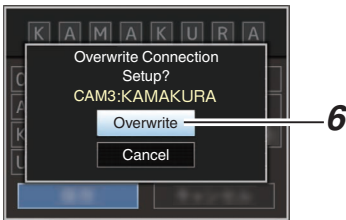

- Saving starts, and “Storing...” appears on the screen when the file is newly saved.

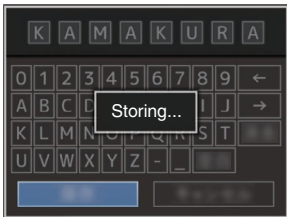

7 Saving is complete.

After saving of the file is complete, “Complete” appears on the screen, and the menu screen closes automatically.

Reading the Connection Settings File

- 1 Select [Network] → [Connection Setup] → [Setup File] [CHU] [CHE] / [USB Setup File] [STU] [RCHE] and press the Set button (●).
- 2 Select [Load] and press the Set button (●).

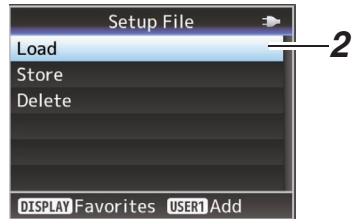

- 3 Select the file to read using the cross-shaped button (▲▼), and press the Set button (●).



- 4 Select [Load] on the confirmation screen, and press the Set button (●). Loading starts, and “Loading...” appears on the screen.

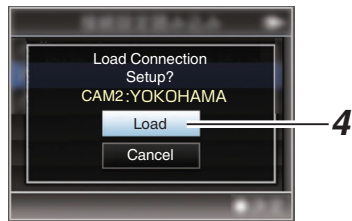

5 Reading is complete.

After reading of the file is complete, “Complete” appears on the screen, and the menu screen closes automatically.

Deleting Connection Settings

- 1 Select [Network] → [Connection Setup] → [Setup File] [CHU] [CHE] / [USB Setup File] [STU] [RCHE] and press the Set button (●).
- 2 Select [Delete] and press the Set button (●).

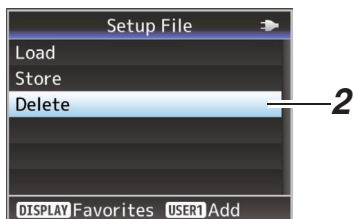

- 3 Select the file to delete using the cross-shaped button (▲▼), and press the Set button (●).



- 4 Select [Delete] on the confirmation screen, and press the Set button (●).
Deletion starts, and "Deleting..." appears on the screen.



- 5 **Deletion is complete.**
After file deletion is complete, "Complete" appears on the screen.

Performing Live Streaming

By combining with the decoder or PC application that supports live streaming, you can perform audio and video streaming via the network.

Supported Formats

Record Format				Usable Formats for Live Streaming							
System	Format	Resolution	Frame Rate	1920x1080, 60p	1920x1080, 60i	1920x1080, 30p	1280x720, 60p	1280x720, 30p	720x480, 60i	640x360, 60p	640x360, 30p
HD HD(SDI In)	QuickTime (H.264)	1920x1080	60p	✓	✓	✓	✓	✓	✓	✓	✓
			60i	-	✓	✓*	✓*	✓*	✓	✓*	✓*
			30p	-	-	✓*	-	✓*	-	-	✓*
	1280x720	60p	-	-	-	✓	✓	✓	✓	✓	✓
		Exchange (U model)	1920x1080	60p	✓	✓	✓	✓	✓	✓	✓
	1280x720	60p	-	-	-	✓	✓	✓	✓	✓	✓
		QuickTime (MPEG2) MXF (MPEG2)	1920x1080	60i	-	✓	✓*	✓*	✓*	✓	✓*
	30p			-	-	✓*	-	✓*	-	-	✓*
1440x1080	60i	-	✓	✓*	✓*	✓*	✓*	✓	✓*	✓*	
	1280x720	60p	-	-	-	✓	✓	✓	✓	✓	
SD SD(SDI In) (U model)	QuickTime (H.264)	720x480	60i	-	-	-	-	-	✓	-	-

Record Format				Usable Formats for Live Streaming								
System	Format	Resolution	Frame Rate	1920x1080, 50p	1920x1080, 50i	1920x1080, 25p	1280x720, 50p	1280x720, 25p	720x576, 50i	640x360, 50p	640x360, 25p	
HD HD(SDI In)	QuickTime (H.264)	1920x1080	50p	✓	✓	✓	✓	✓	✓	✓	✓	
			50i	-	✓	✓*	✓*	✓*	✓	✓*	✓*	
			25p	-	-	✓*	-	✓*	-	-	✓*	
	1280x720	50p	-	-	-	✓	✓	✓	✓	✓	✓	
		MP4 (E model)	1920x1080	50p	✓	✓	✓	✓	✓	✓	✓	✓
	1280x720		50p	-	-	-	✓	✓	✓	✓	✓	
	QuickTime (MPEG2) MXF (MPEG2)	1920x1080	50i	-	✓	✓*	✓*	✓*	✓*	✓	✓*	✓*
			25p	-	-	✓*	-	✓*	-	-	✓*	
1440x1080	50i	-	✓	✓*	✓*	✓*	✓*	✓	✓*	✓*		
	1280x720	50p	-	-	-	✓	✓	✓	✓	✓		
SD SD(SDI In) (E model)	QuickTime (H.264)	720x576	50i	-	-	-	-	-	✓	-	-	

* Not selectable when the setting is configured to HD(SDI In) or SD(SDI In).

Formats Supported on KA-EN200 (Sold Separately)

Record Format				Usable Formats for Live Streaming			
System	Format	Resolution	Frame Rate	1920x1080, 60p	1920x1080, 30p	1280x1080, 60p	1280x1080, 30p
HD	QuickTime (H.264)	1920x1080	60p	✓	✓	✓	✓
			60i	✓	✓	✓	✓
			30p	-	✓	-	✓
		1280x720	60p	-	-	✓	✓
	Exchange (U model)	1920x1080	60p	✓	✓	✓	✓
		1280x720	60p	-	-	✓	✓
	QuickTime (MPEG2) MXF (MPEG2)	1920x1080	60i	✓	✓	✓	✓
			30p	-	✓	-	✓
		1440x1080	60i	✓	✓	✓	✓
		1280x720	60p	-	-	✓	✓

Record Format				Usable Formats for Live Streaming			
System	Format	Resolution	Frame Rate	1920x1080, 50p	1920x1080, 25p	1280x1080, 50p	1280x1080, 25p
HD	QuickTime (H.264)	1920x1080	50p	✓	✓	✓	✓
			50i	✓	✓	✓	✓
			25p	-	✓	-	✓
		1280x720	50p	-	-	✓	✓
	MP4 (E model)	1920x1080	50p	✓	✓	✓	✓
		1280x720	50p	-	-	✓	✓
	QuickTime (MPEG2) MXF (MPEG2)	1920x1080	50i	✓	✓	✓	✓
			25p	-	✓	-	✓
		1440x1080	50i	✓	✓	✓	✓
		1280x720	50p	-	-	✓	✓

* The 4:2:2 and 4:2:0 modes are available for selection when the frame rate is 60p/50p.

Memo : _____

- The distributable resolution, frame rate and bit rate vary according to the recording format.
- To distribute progressive video, set the frame rate to any of the progressive frame rates. And to distribute interlace video, set the frame rate to any of the interlace frame rates.
- The following constraints apply depending on the setting of [Network] → [Live Streaming] → [Type].
 - A bit rate not exceeding maximum 12 Mbps can be configured when [Type] is set to “RTSP/RTP”.
 - When [Type] is set to “ZIXI”, a bit rate not exceeding maximum 12 Mbps can be configured regardless of the [Latency] setting.
 - Depending on the type of network adapter used and the connection, the images and audio sound during live streaming can be choppy.

Audio

AAC

Supported Protocols

MPEG2-TS/UDP

MPEG2-TS/TCP

MPEG2-TS/RTP

RTSP/RTP

ZIXI

SRT

RTMP

RTMPS

Memo : _____

- The model is equipped with the Zixi protocol, thus SRT protocol update needs to be performed before using the SRT protocol. Doing so will make the Zixi protocol unusable. To enable the use of the Zixi protocol again, perform Zixi protocol update.

Setting Distribution

1 Set the [Record Format] according to the resolution and frame rate of the video to be distributed.

For details on the [Record Format] settings, please refer to [Distributable [Record Format] and [Live Streaming Set] Combinations] (P 223).

Memo : _____

- Live streaming cannot be performed in the following cases.
 - When [System] → [Record Set] → [Record Format] → [System] is set to “HD+Web” or “High-Speed”
 - When [System] → [Record Set] → [Record Format] → [Frame Rate] is set to “24p”

2 Set the Resolution and Frame & Bit Rate for the video to be distributed.

Specify the settings in [Network] → [Live Streaming].
(P145 [Live Streaming Item])

3 Specify the distribution protocol and related items.

Specify the distribution protocol and related items in [Network] → [Live Streaming] → [Streaming Server].
(P146 [Streaming Server])

4 Select the server for live streaming.

Select the distribution server in [Network] → [Live Streaming] → [Server].

Distributable [Record Format] and [Live Streaming Set] Combinations

- When [Optional Adapter] is configured to “Disable” (H.264 streaming)

Resolution	1920 x 1080											
Frame Rate	60p, 50p						60i, 50i			30p, 25p		
Type	MPEG2-TS/UDP			MPEG2-TS/TCP			MPEG2-TS/RTP			RTSP/RTP		
Bit Rate	MPEG2-TS/UDP			MPEG2-TS/TCP			MPEG2-TS/RTP			RTSP/RTP		
	ZIXI, SRT	RTMP	RTMPS	ZIXI, SRT	RTMP	RTMPS	ZIXI, SRT	RTMP	RTMPS	ZIXI, SRT	RTMP	RTMPS
24 Mbps	■*2											
20 Mbps	■*2	■*2					●*2				●*2	
16 Mbps	■*2	■*2	■*2				●*2	●*2			●*2	●*2
12 Mbps	■	■	■	■			●	●			●	●
8 Mbps	■	■	■	■			●	●	●		●	●
5 Mbps							●	●	●		●	●
3 Mbps							●	●	●		●	●
1.5 Mbps												
0.8 Mbps												
0.3 Mbps												

* ●: Distributable

■: Distributable when [Format] is configured as follows.

- QuickTime(H.264), Exchange (U model)
- MP4(H.264) (E model)

*1 : Distribution at a bit rate of 12 Mbps is possible when [FEC] is configured to “Off”.

- *2 : Distribution is disabled when [System] is configured to “HD” and the following are configured.
- When [Format] is configured to “QuickTime(H.264)”, “Exchange” (U model) or “MP4(H.264)” (E model), [Overlay Function] is configured to “Enable” and [Overlay Settings] → [Output] is configured to “Off”
 - [Overlay Function] is configured to “Enable” when [Format] is configured to “QuickTime(MPEG2)” or “MXF(MPEG2)”

Resolution	1280 x 720						720x480 or 720x576			640 x 360						
Frame Rate	60p, 50p			30p, 25p			60i or 50i			60p, 50p		30p, 25p				
Type																
Bit Rate	MPEG2-TS/UDP	MPEG2-TS/TCP	MPEG2-TS/RTMP	RTSP/RTMP	ZIXI, SRT	RTMP	MPEG2-TS/UDP	MPEG2-TS/TCP	MPEG2-TS/RTMP	ZIXI, SRT	RTMP	MPEG2-TS/UDP	MPEG2-TS/TCP	MPEG2-TS/RTMP	ZIXI, SRT	RTMP
24 Mbps																
20 Mbps	●*1	●*1														
16 Mbps	●*1	●*1														
12 Mbps	●	●														
8 Mbps	●	●		●			●									
5 Mbps	●	●		●			●		●							
3 Mbps	●	●		●			●		●				●			●
1.5 Mbps							●		●				●			●
0.8 Mbps									●				●			●
0.3 Mbps									●				●			●

* ●: Distributable

- *1 : Distribution is disabled when [System] is configured to “HD” and the following are configured.
- When [Format] is configured to “QuickTime(H.264)”, “Exchange” (U model) or “MP4(H.264)” (E model), [Overlay Function] is configured to “Enable” and [Overlay Settings] → [Output] is configured to “Off”
 - [Overlay Function] is configured to “Enable” when [Format] is configured to “QuickTime(MPEG2)” or “MXF(MPEG2)”
- When [Optional Adapter] is configured to “Enable” (H.265/HEVC streaming using KA-EN200)

Resolution	1920 x 1080 4:2:2 10bit			1920 x 1080 4:2:0 8bit		1280 x 720 4:2:2 10bit		1280 x 720 4:2:0 8bit	
Frame Rate	60p, 50p			60p, 50p, 30p, 25p		60p, 50p		60p, 50p, 30p, 25p	
Type									
Bit Rate	MPEG2-TS/UDP	ZIXI	SRT(*)	MPEG2-TS/UDP	ZIXI, SRT(*)	MPEG2-TS/UDP	ZIXI, SRT(*)	MPEG2-TS/UDP	ZIXI, SRT(*)
24 Mbps	●								
20 Mbps	●								
16 Mbps	●			●		●			
12 Mbps	●	●		●		●			
8 Mbps	●	●	●	●	●	●	●	●	●
5 Mbps				●	●	●	●	●	●
3 Mbps				●	●	●	●	●	●
1.5 Mbps				●	●	●	●	●	●
0.8 Mbps								●	
0.3 Mbps									

* Streaming at a bit rate of 8 Mbps is possible when [FEC] is configured to “Off”.

Starting Distribution

1 Perform the necessary setting for the decoder and PC application.

For details on the settings, please refer to the “INSTRUCTIONS” of the respective devices and applications.

Memo : _____

- If there is an NAT router within the communication path between the camera and the decoder, port forwarding setup is required. For details on the settings, please refer to the “INSTRUCTIONS” of the router in use.
- The following parameters are required when connecting to this camera recorder using the RTSP/RTP.
 - Port number: 554
 - Stream ID: stream
- Use the following to access via URL.
rtsp://<IP address of the camera recorder>:554/stream

2 With the network connection established, set [Live Streaming] to “On”.



(☞ P195 [Preparing Network Connection])

- Set [Network] → [Live Streaming] → [Live Streaming] to “On”.
- The network connection mark appears on the display screen when a network connection is established.

(☞ P173 [Network Connection Icon])

Memo : _____

- You can also assign “Live Streaming” to a user button.
(☞ P45 [Assignment of Functions to User Buttons])
- You can view the status of distribution on the LCD monitor.
(☞ P175 [Live streaming mark])

Icon	Status
 (Red)	Distribution in progress (good connection quality) Blinks when distribution starts or stops
 (Red)	Distribution in progress (poor connection quality)
 (Yellow)	Waiting for connection (during RTSP/RTP) or connection failed

- When the  icon is displayed, you can view the details of the error on the [Streaming] screen of the status screen.

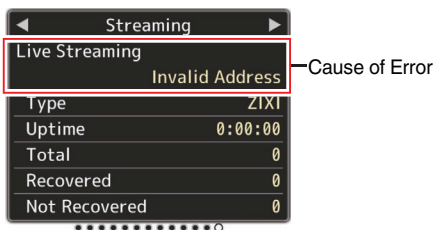

(☞ P241 [List of Live Streaming Error Displays])

Caution : _____

- Streaming may be interrupted temporarily 24 hours after the process started.

Setting the FEC Matrix

Set the amount of FEC (Forward Error Correction) overhead for configuring SMPTE2022-1.

- 1 Select [Network] → [Live Streaming] → [Streaming Server] → [Server1] to [Server4] → [FEC Matrix] and press the Set button.

The FEC adjustment screen appears.

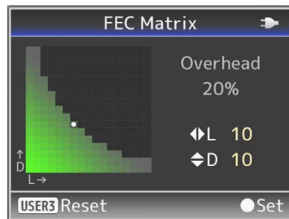

- 2 Adjust the L and D values.

Use the ◀▶ buttons to adjust the L value, and the ▲/▼ buttons to adjust the D value.

The amount of FEC overhead changes when the L and D values are changed.

To restore the L and D values to their default values, press the [USER3] button.

Memo : _____

- Setting range
 - $4 \leq L \leq 20$ (Default value: $L = 10$)
 - $4 \leq D \leq 20$ (Default value: $D = 10$)
 - $L \times D \leq 100$ (Default value: $L \times D = 10 \times 10$)

- 3 Press the Set button (●).

The screen returns to the streaming server setting screen.

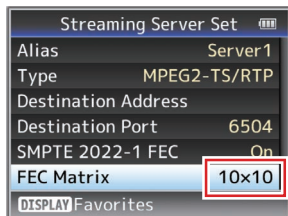

Memo : _____

- Increasing the amount of FEC overhead increases the packet loss resilience but more network bandwidth is used.
- Even with the same amount of overhead, increasing the L value will increase the packet loss (continuous packet loss) resilience.

Return Video/Audio from the Network (Return over IP)

Return video/audio from the network can be displayed on the viewfinder or LCD monitor of the camera or listened through a headphone.

Memo : _____

- This feature is only usable in the Camera mode.
- Start the encoder before activating Return over IP. To end, turn off Return over IP before shutting down the encoder. When the bit rate or frame rate of the encoder is changed, adjust the camera settings according to the encoder settings, followed by restarting the camera.
- This feature is available when [System] → [Record Set] → [Record Format] → [System] is set to "HD" or "SD". When [A]Frame Rate is set to "24p", this feature is not available. (☞ P143 [Return over IP...])

Configuring the Return over IP Server

Configure the Return over IP settings and establish the connection before displaying the return video.

1 Register the [Return Server].

Configure [Network] → [Return over IP] → [Server] to "Server".

Configure the individual settings in the [Return Server] item.

Memo : _____

- For details on the registered information, please consult the network administrator for the server.
- Configure "Iccast" to a setting other than [Type].
Operates as IFB when the setting is configured to "Iccast".

Return Video and Audio from the Network

1 Set the camera recorder to the Camera mode.

(☞ P20 [Operation Modes])

2 Assign the "Return Video" and "Return over IP" features to any of the user buttons.

(☞ P45 [Assignment of Functions to User Buttons])

Memo : _____

- The "Return over IP" feature can also be operated using "On"/"Off" under [Network] → [Return over IP] → [Return over IP].

3 Configure the input destination of the return video to "Network".

To specify the input destination of the return video, configure [A/V Set] → [Video Set] → [Return Input] to "Network".
(☞ P138 [Return Input])

Memo : _____

- When [System] → [Record Set] → [Record Format] → [System] is configured to "HD(SDI In)" or "SD(SDI In)", "---" is displayed and the setting cannot be configured.

4 Select the aspect ratio of the return video.

Set using [A/V Set] → [Video Set] → [Return Aspect].
(☞ P138 [Return Aspect])

5 Press the user button that is assigned with the "Return over IP" function.

When Return over IP is activated, the settings in [A/V Set] → [Audio Set] → [IFB/RET Monitor] will be applied to the audio.
(☞ P141 [IFB/RET Monitor...])

6 Select the way the return video is to be displayed.

Select in [Camera Function] → [User Switch Set] → [Return Video]. The camera will operate according to the setting.
(☞ P116 [Return Video])

7 Press the user button that is assigned with the "Return Video" function.

By pressing the user button assigned with the "Return Video" function, the captured image or return video is displayed according to the method specified in step 6.

IFB (Return Audio)

Return audio from the network can be played through a headphone.

Memo : _____

- This feature is only usable in the Camera mode.
- Start the encoder before activating Return over IP. To end, turn off Return over IP before shutting down the encoder. When the bit rate or frame rate of the encoder is changed, adjust the camera settings according to the encoder settings, followed by restarting the camera.
- This feature is available when [System] → [Record Set] → [Record Format] → [System] is set to “HD” or “SD”. When [A]Frame Rate is set to “24p”, this feature is not available. (☞ P143 [Return over IP...])

Configuring the Return over IP Server

Configure the Return over IP settings and establish the connection before displaying the return video.

1 Register the [Return Server].

Configure [Network] → [Return over IP] → [Server] to “Server”.

Configure the individual settings in the [Return Server] item.

Memo : _____

- For details on the registered information, please consult the network administrator for the server.
- Configure “Iccast” to [Type]. Operates as IFB when the setting is configured to “Iccast”.

Return Audio from the Network (IFB)

1 Set the camera recorder to the Camera mode.

(☞ P20 [Operation Modes])

2 Assign the “Return over IP” function to any of the user buttons.

(☞ P45 [Assignment of Functions to User Buttons])

Memo : _____

- The “Return over IP” feature can also be operated using “On”/“Off” under [Network] → [Return over IP] → [Return over IP].

3 Configure the input destination of the return video to “Network”.

To specify the input destination of the return video, configure [A/V Set] → [Video Set] → [Return Input] to “Network”.

(☞ P138 [Return Input])

Memo : _____

- When [System] → [Record Set] → [Record Format] → [System] is configured to “HD(SDI In)” or “SD(SDI In)”, “---” is displayed and the setting cannot be configured.

4 Press the user button that is assigned with the “Return over IP” function.

When Return over IP is activated, the settings in [A/V Set] → [Audio Set] → [IFB/RET Monitor] will be applied to the audio.

(☞ P141 [IFB/RET Monitor...])

Tagging Feature **CHU** **STU**

When using the Exchange file format, entering the tag information on the camera recorder helps to ease the management of tags during editing.

Configuring to Exchange Format

To use the tagging feature, configure [System] → [Record Set] → [Record Format] → [A]Format to “Exchange”.

(☞ P56 [Selecting System Definition, File Format and Video Format])

Configuring Camera Angle Information

Camera angle information can be recorded to the metadata of the recorded clip.

Configure the settings in [Camera Function] → [Camera Angle[Tagging]].

(☞ P113 [Camera Angle[Tagging] **CHU** **STU**])

Entering Tag Information

Tag information can be entered on the camera recorder or via the web function of the camera recorder.

Entering Tag Information on the Camera Recorder

- 1 **Assign the tag to a user button.**
(☞ P113 [User Switch Set Item])
- 2 **Press the user button that is assigned with the tag.**
- 3 **Start recording.**
- 4 **To make changes, press the user button that is assigned with the tag.**
- 5 **Stop recording.**
The tag is recorded to the .xchange file.

Entering Tag Information via the Web Function

- 1 **Access the web function of this camera recorder via a web browser on devices such as a smartphone, tablet terminal or PC, and display the main page.**
(☞ P195 [Preparing Network Connection])
(☞ P204 [Connecting from a Web Browser])
- 2 **Press the “Sports Tagging” button to display the tag input screen.**
- 3 **Enter the tag information and press the “Enter” button.**
Enter “Title 1” and “Title 2” manually or using the template input button.
- 4 **Start recording.**
- 5 **To make changes, enter the tag information and press the “Enter” button.**
Enter “Title 1” and “Title 2” manually or using the template input button.
- 6 **Press the Set button.**
- 7 **Stop recording.**
The tag is recorded to the .xchange file.



- 1 **Sports Tagging Button**
- 2 **Current setting**
Displays the text strings entered for [Title 1] and [Title 2] just before the Set button is last pressed.
- 3 **Data input boxes [Title 1] and [Title 2]**
Text can be entered into the boxes directly. For smartphones or tablets, tapping the box displays a OS keyboard.
- 4 **Clear button**
Clears the text in the [Title 1] and [Title 2] boxes.

5 Set button

Sends the text strings in [Title 1] and [Title 2] to the camera recorder and the tag data of the clip is updated. Update of the tag data is possible while recording is in progress.

6 Template input button

Enters a template phrase into the [Title 1]. (Example) Pressing the [KO] button enters KO into "Title 1".

7 REMOVE Button

Adds a REMOVE flag to the .xchange file of the clip that is currently being recorded. When recording is paused during Clip Continuous recording, pressing the REMOVE button adds a REMOVE flag to the .xchange file that was last recorded.

8 Stop Record Button

Stops clip recording by the camera recorder. This button is active only during clip recording by the camera recorder.

9 Start Record Button

Starts clip recording by the camera recorder. This button is active only when the camera recorder is ready to start recording.

Memo : _____

- You can enter up to 64 characters for "Title 1" and up to 128 characters for "Title 2".
- Changing (including clearing) the text in the "Title 1" and "Title 2" boxes does not automatically update the tag data of the recorded clip. Make sure to press the Set button to confirm the change. Changes in the tag data cannot be made to clips for which recording has already ended.
- Input of tag data in file formats other than MOV is not guaranteed.
- When a recorded clip is split into multiple files, the same tag information may not be saved to all the files depending on the timing at which the tag information is updated. It is recommended that a SDXC card be used with [System] → Record Set → [4GB File Spanning(SDXC)] configured to "Off".

Synchronizing GPS Time Code **CHU**

Time code information can be synchronized with the date/time information acquired from the GPS.

(☞ P85 [Acquiring Positioning Information by GPS])

Configuring the TC Mode

Set [TC/UB] → [TC Mode] to "GPS".

(☞ P126 [TC Mode])

Memo : _____

- When [System] → [Record Set] → [Rec Mode] is configured to "Interval Rec" or "Frame Rec", "GPS" cannot be selected.
- The  icon lights up when the time code is synchronized.

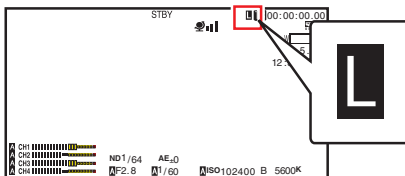

Broadcast Overlay

Texts, images and watermark can be overlaid onto recorded videos and live streaming videos from a smartphone or tablet device by importing the SDP file for broadcast.

Available when [System] is set to “HD” or “HD+Web”.

Use the SDP Generator to create the SDP file for broadcast.

- For information on SDP Generator, please contact your local dealer or download from our website.
<http://www.jvc.net>

Caution : _____

- Regardless of the recording resolution (1920x1080, 1440x1080, 1280x720), the SDP file resolution that can be used on this camera recorder is fixed at 1920x1080.

Memo : _____

- Configuring Type to “Broadcast” in the factory settings displays a sample of the overlaid image.
- Check the display and operation in advance before recording or live streaming starts.

Importing and Configuring Settings for SDP Files for Broadcast

Memo : _____

- When the recording format is “HD+Web”, the scoreboard display is always overlaid on the “Web” recording clip.
- The scoreboard display is always overlaid on live video streaming.
- The settings cannot be changed during recording or live streaming.

1 Set [Overlay Settings] ⇒ [Overlay Function] to “Enable”.

When [System] is configured to a setting other than “HD” and “HD+Web”, this item is fixed at “Disable”.

2 Use [Overlay Settings] ⇒ [Import User Layout] to import the file.

To use an overlay other than the SDP file at factory default, import the SDP file for broadcast to the camera.

3 Select the file for overlay from the imported file in [Overlay Settings] ⇒ [Layout].

4 Select “Broadcast” in [Overlay Settings] ⇒ [Type].

When the SDP file selected in [Layout] is created in a type other than “Broadcast”, or when the recording resolution of the “Broadcast” type of the SDP file is different from the recording resolution of the current camera, “Broadcast” is not displayed in [Type].

- Broadcast:

Watermark



- None: No display

5 Select the display in [Overlay Settings] ⇒ [Output] ⇒ [REC]/[SDI OUT2]/[HDMI OUT]/[VIDEO OUT].

(☞ P155 [REC])

(☞ P155 [SDI OUT2])

(☞ P156 [HDMI OUT])

(☞ P156 [VIDEO OUT])

Entering Overlay Text

1 Connect this camera recorder to the network.

(☞ P194 [Connecting to the Network])

2 Connect from a web browser.

(☞ P204 [Connecting from a Web Browser])

3 When the web browser screen appears, press the overlay icon at the top of the screen or the [Overlay Control] button to display the input screen.



4 One of the following screens appears according to the setting for [Type] in the camera recorder menu.

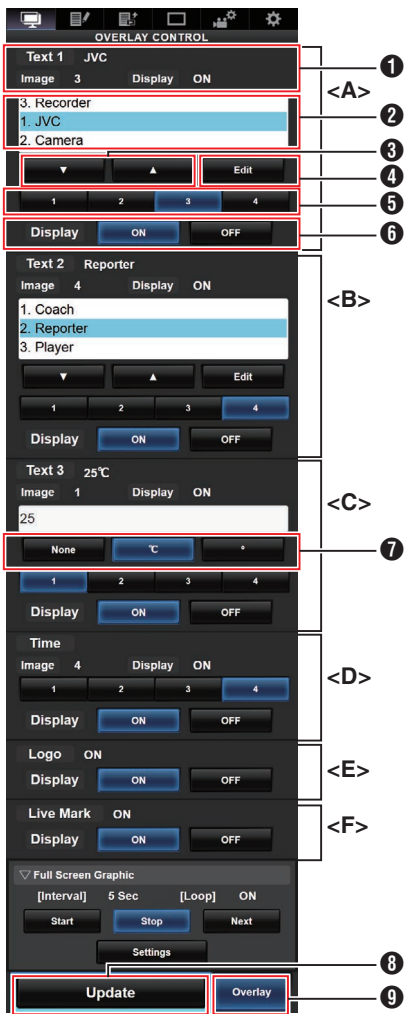

- Memo:
- Range <A> Text 1
 - Range Text 2
 - Range <C> Text 3
 - Range <D> Time
 - Range <E> Logo
 - Range <F> Live mark
- ① Shows the current overlay status.
 - ② Text selection area
The highlighted text is overlaid and displayed.
 - ③ [▼] [▲] Button
Selects the text.
 - ④ [Edit] Button
Switches to the text entry mode.
 - ⑤ [1][2][3][4] Button
Selects the image.
 - ⑥ [Display] Button
Displays or hides specific areas.
 - ⑦ Unit Button
Selects the unit to add after Text 3.
 - ⑧ [Update] Button
Reflects the changed content in the overlay display.
 - ⑨ [Overlay] Button
Displays or hides the overlay.

Text that can be entered in [Text 1], [Text 2], and [Text 3] are as follows:

```

! " # $ % & ' ( ) * + , - . / 0 1 2 3 4 5 6 7 8 9
: ; < = > ? @ A B C D E F G H I J K L M N O P Q R S T U
V W X Y Z [ \ ] ^ _ ` a b c d e f g h i j k l m n
o p q r s t u v w x y z { | } ~ ¡ ¢ £ ¤ ¥ ¦ § ¨
© ª « ¬ ® ¯ ° ± ² ³ ´ µ ¶ · ¸ ¹ º » ¼ ½ ¾ ¿
À Á Â Ã Ä Å Æ Ç È É Ê Ë Ì Í Î Ï Ñ Ò Ó Ô Õ Ö ×
Ø Ù Ú Û Ü Ý Þ ß à á â ã ä å æ ç è é ê ë ì í î ï
ð ñ ò ó ô õ ö ÷ ø ù ú û ý þ ÿ Ğ ğ İ İ Ö Eoe Şş Šš Ÿ
Žž ƒ ~ — “ ” „ † ‡ • … ‰ ‹ › € ™
    
```

- Memo :
- Not more than 5 lines can be entered for Text 1 and Text 2 each. Up to 63 bytes can be entered for each line.
 - Up to 5 bytes can be entered for Text 3.
 - For some types of text, the text that has been entered may not be displayed fully on the overlaid display. Check the display in advance.

Displaying Watermark Images

Import the SDP file in which the watermark image has been preconfigured to the camera recorder in advance.

The watermark setting menu will be displayed in the [Overlay Settings] menu screen only when the SDP file for broadcast is selected in [Overlay Settings] → [Layout].

- 1 Set [Overlay Settings] → [Watermark] to "On".
- 2 Select [Overlay Settings] → [Position].
 - The watermark position setting screen appears.
 - The position is moved 2 steps at a time.
 - The displayed coordinates shows the position at the top left of the watermark image.
- 3 Use the cursor to move the watermark and press the Set (●) button.

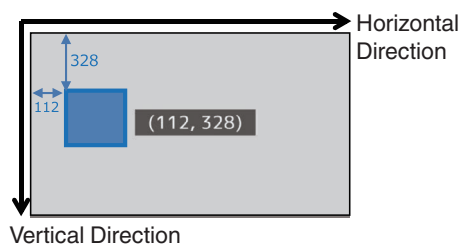

Displaying Images on the Whole Screen (Full Screen Graphic Function)

Announcement and advertising images can be displayed across the whole screen.



Importing Images for Display to the Camera

- 1 Prepare the image for display.
 - JPEG (extension .jpg) and PNG (extension .png) formats are supported.
- 2 Copy the image file to the root directory of the SD card.
 - Use an SD card of a recordable specification in the current camera recording settings.
 - Up to 50 image files can be displayed.
 - The order of display by file name can be specified.

Memo : _____

- Add a two-digit number of 01 to 50 at the start of the file name. Files will be displayed in the order starting from those having the smallest number in the file name.
Example: When 01flower.png, 02car.jpg, 13red.png are imported, they are displayed in the order of 01flower.png → 02car.jpg → 13red.png.
- Only alphanumeric characters and underscore (_) can be used for the third character onwards in the file name.
- Enter not more than 31 characters for the file name.

- 3 Select [Overlay Settings] → [Full Screen Graphic].
- 4 Insert the SD card where the image files are copied into the SD card slot A or B of the camera, and select [Import Graphic^A] or [Import Graphic^B] to import.
 - Once import is performed, all images previously imported will be deleted.
 - To delete the imported image files, select [Overlay Settings] → [Full Screen Graphic] → [Delete Graphic].

Memo : _____

- The total number of currently imported image files and the used capacity can be checked in [Overlay Settings] → [Full Screen Graphic] → [Status]. This capacity may be bigger than the actual image file size.
- The maximum import size is approx. 23 MB, after combining the capacity that can be checked in [Status] and the size of the imported SDP files.
- Images that can be displayed are as follows:
 - Image Size: 960x540
 - File Size: 1MB and below
 - JPEG:
 - Gradation: 8 bit
 - Pixel format: YCbCr or grayscale
 - Baseline JPEG
 - PNG:
 - Bit/Channel: 1, 2, 4, 8
 - Pixel format: Grayscale, Index, True color (RGB), grayscale with alpha, true color with alpha (RGBA)
 - Non-interlaced PNG
- When images that cannot be displayed are imported to the camera, an error message “Unsupported Graphic Format” is displayed on the camera recorder while image display is in progress. Check in advance that images can be displayed as per expectation.

Displaying Images

Display the image from the web screen for setting the overlay.

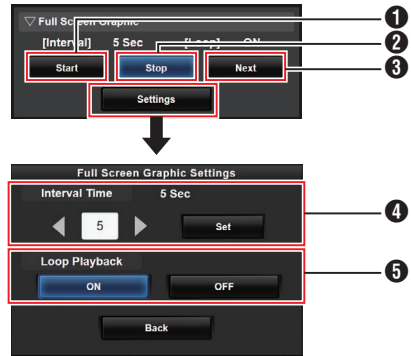

- 1 Start:**
Starts the display of images.
- 2 Stop:**
Stops the display of images.
- 3 Next:**
Image in : Displays the next image.
display
Image : Starts displaying from the next not in image of the image at which the display display stopped previously.
Depending on the status of the camera, it may take a while to display the next image after pressing the [Next] button.
- 4 Interval Time:**
Sets the display time per image.
Depending on the status of the camera, it may take a while to display the next image after pressing the [Start] button. A time longer than the configured interval time may be displayed.
- 5 Loop Playback:**
Select [ON] to return to the first image after the last image is displayed.

Memo : _____

- To display only one image continuously, set [Interval Time] to "0".
- When recording is performed together with live streaming or when there is a lot of information display on the LCD/VF screen, images may take more than 10 seconds to display. It is possible to reduce the time taken to display by lowering the resolution of the recording and live streaming or by pressing the [DISPLAY] button of the camera recorder to turn off the display screen.
- To use only the Full Screen Graphic function without the overlay display, select [Overlay Settings] → [Type] and choose options other than "None". Then, set the [Overlay] button on the web screen for controlling the overlay to Off.
- When the format of the next image to be displayed is not supported during image display, "Unsupported Graphic Format" will be displayed on the camera recorder, and that image will not be displayed. Import images that support a displayable format.

(P233 [Importing Images for Display to the Camera])

Protecting Overlay Settings with a Password

You can use a password to protect overlay settings to prevent the cancellation of watermark display by a third party.

Protecting with a Password

- 1 **Set [Overlay Settings] → [Password Lock] to "On".**
- 2 **Enter the protection password and press the cross-shaped button (▶).**
Enter not more than 16 characters for the password using the software keyboard.
- 3 **Enter the same password again and press the cross-shaped button (▶).**
- 4 **Press [Set].**
A password request screen will appear subsequently before you enter the [Overlay Settings] screen.

Caution : _____

- Do not forget the password that you have set. If the password is lost or forgotten, you cannot deactivate the password protection function.

Memo : _____

- When overlay settings are protected by a password, the following items in [System] are grayed out and cannot be selected.
 - [Reset All]
 - [Record Set] → [Record Format]
 - [Setup File] → [Load File] → [Picture File]/[User File]/[All File]
 - [Setup File] → [Store File] → [Picture File]/[User File]/[All File]
-

Deactivating Password Protection

- 1 **Select [Overlay Settings].**
A password request screen appears.
- 2 **Enter the password and press the cross-shaped button (▶).**
If the password matches the configured password, the [Overlay Settings] menu appears.
- 3 **Change [Password Lock] to "Off".**
- 4 **Press [Set] to close the deactivation complete screen.**

Specifying Text and Images

- 1 **Connect the camera recorder to a network compatible device such as a mobile device via the network.**

When network connection is established between the devices, start the Web browser on the network compatible device.

- 2 **Enter the following URL in the address bar of the Web browser.**

http:// "IP address of camera recorder"

Example; http://192.168.0.1

You can check the "IP address of camera recorder" by pressing the [STATUS] button on the camera recorder to display the Status screen and use the cross-shaped button (◀▶) to display the Network screen.

- 3 **Enter the user name and password.**
Enter the user name and the password on the login screen to display the main page of the camera.
- 4 **Press the overlay control icon at the top of the screen or the [Overlay Control] button to display the Settings screen.**

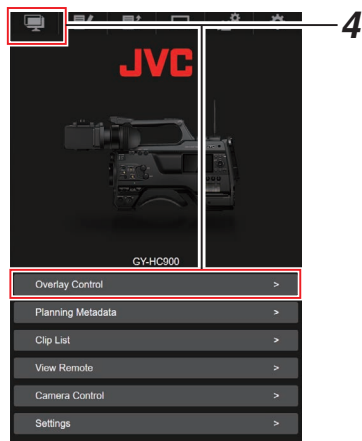

- 5 **Press the [Update] button to reflect the specified text and images in the overlay.**

Error Messages and Actions

Warning display on the LCD monitor and viewfinder screen, tally lamp indication and warning tone are as follows according to the error status.

Memo : _____

- This camera recorder makes use of a microcomputer. Noise interference from external sources may prevent it from functioning properly. When this occurs, turn off and on the power of the camera recorder again.

Error Message	Status	Action
Turn Power Off Turn Back On Later	System error. * The warning tone sounds and the tally lamp blinks twice every second.	Turn off the power, and turn it on again. If the error persists, please contact the local dealers in your area.
Fan Stop Detected Please Turn P.Off	<ul style="list-style-type: none"> • The fan stopped running. 	Please contact the local dealers in your area.
Fan Maintenance Required	Usage time of the fan has exceeded 9000 hours.	Check the fan and replace accordingly. For more details, please contact the local dealers in your area. Memo : _____ <ul style="list-style-type: none"> • You can check the usage time of the fan in [System] ➔ [System Information] ➔ [Fan Hour]. (☞ P159 [Fan Hour])
Getting Overheated. Please Turn Power Off.	<ul style="list-style-type: none"> • The battery has exceeded the specified temperature. • The power turns off automatically after about 15 second. 	<ul style="list-style-type: none"> • Wait until the temperature drops or replace the battery. • If the error persists, please contact the local dealers in your area.
Rec Inhibited	[REC] button is pressed when the write-protect switch of the SD card is set.	Turn off the write-protect switch of the SD card, or insert a recordable SD card. (☞ P47 [Recording Media])
Lost Media Info *	<ul style="list-style-type: none"> • Card is removed while recording is in progress. • Card is removed while formatting is in progress. • Card is removed while restoring is in progress. • Card is removed while adding the OK mark. • Card is removed while writing a setup file. • Card is removed while deleting a clip. (*: A, B)	Restore the card using this camera recorder. (☞ P52 [Repairing the Recording Media])

Error Message	Status	Action
Record Format Incorrect	<ul style="list-style-type: none"> The video format of the file for Clip Review is different from the current [A Resolution], [A Frame Rate], or [A Bit Rate] setting. 	Set [A Resolution], [A Frame Rate] and [A Bit Rate] correctly. (☞ P161 [A Resolution/ EXT Resolution]) (☞ P161 [A Frame Rate/ EXT Frame Rate]) (☞ P162 [A Bit Rate/ EXT Bit Rate])
Media Full	<ul style="list-style-type: none"> [REC] button is pressed when the media in use has no remaining space. Remaining space ran out during recording. 	Replace the recording media with a new one.
No Clips	No viewable clips are found on the card for Clip Review.	Insert an SD card that contains clips that can be reviewed. (☞ P47 [Recording Media]) (☞ P86 [Viewing Recorded Videos Immediately (Clip Review)])
No Media	When the [REC] button is pressed while a recording media is not inserted.	Insert a recording media. (☞ P47 [Recording Media])
No Media	No recording media is inserted while in Media mode or when the thumbnail screen is displayed.	Insert a recording media. (☞ P47 [Recording Media])
No Clips	No clips are found in the inserted recording media while in Media mode or when the thumbnail screen is displayed.	Insert a recording media that contains playable clips. (☞ P47 [Recording Media]) (☞ P97 [Playing Recorded Clips])
Please review the connected devices due to over current.	Peripheral devices are connected in an environment that is subject to high temperature, and overcurrent has occurred as a result. Memo : _____ <ul style="list-style-type: none"> The backlight of the LCD monitor may automatically be adjusted to "Dark" as a form of overcurrent protection. 	Take the necessary actions such as removing the USB devices that are connected to the camera. The power of the camera may shut down if you continue using it in this state.

List of FTP Transfer Errors

If the upload of a recorded clip or download of the metadata setup file (XML format) is not successfully completed, the following errors are displayed.

Error message	Status	Action
Timeout.	Transfer was discontinued due to timeout caused by network transmission or server failure.	<ul style="list-style-type: none"> • Execute again. • Use a different server.
Media Was Removed.	Recording media is removed while FTP transfer is in progress.	Insert the recording media and execute FTP transfer again.
Adapter Was Removed.	The USB network device is removed while FTP transfer is in progress.	Connect the USB network device.
Cannot Connect to Server.	Unable to connect to the FTP server.	Adjust the Server and Port settings for [Metadata Server] or [Clip Server]. (☞ P143 [Metadata Server]) (☞ P154 [Clip Server])
Access Denied.	Access is denied.	Adjust the Server and Port settings for [Metadata Server] or [Clip Server]. (☞ P143 [Metadata Server]) (☞ P154 [Clip Server])
Invalid Username or Password.	Authentication for login to the FTP server failed.	Adjust the Username and Password settings for [Metadata Server] or [Clip Server]. (☞ P143 [Metadata Server]) (☞ P154 [Clip Server])
Invalid Path Was Requested.	The path specified for the FTP server is incorrect.	Adjust the [Clip Server] and [Dir. Path] settings for [Metadata Server] or [File Path]. (☞ P143 [Metadata Server]) (☞ P154 [Clip Server])
Server Error.	There was an unintended operation of the FTP server.	Execute again. Use a different server.
Invalid Request.	A bad request is executed for the FTP server.	Execute again.

Error message	Status	Action
Invalid Data Size.	Invalid data size, such as a planning metadata size that exceeds 4 KB.	Adjust the planning metadata saved in the [Metadata Server]. (☞ P205 [Planning Metadata])
Invalid Data Format.	The XML format of the planning metadata is invalid.	Adjust the planning metadata saved in the [Metadata Server]. (☞ P205 [Planning Metadata])
Transfer Error.	Transfer failed due to communication failure.	Execute again.
Invalid URL.	The path was deemed invalid by the FTP server.	Adjust the Server and Port settings for [Metadata Server] or [Clip Server]. (☞ P143 [Metadata Server]) (☞ P154 [Clip Server])
Media Access Error.	Reading/writing of the recording media failed while FTP transfer is in progress.	Use a different recording media.
Internal Error.	An internal error has occurred while FTP transfer is in progress.	Adjust the settings and execute again.
Other Error.	An unknown error or other errors have occurred while FTP transfer is in progress.	Adjust the settings and execute again.
Media Read Error.	Reading of the recording media failed while FTP transfer is in progress.	Use a different recording media.

List of Live Streaming Error Displays

The following error messages are displayed when the live streaming setting is incorrect, or when the connection is lost during live streaming.

Error message	Status	Action
Invalid Address	<ul style="list-style-type: none"> The IP address format is incorrect. The domain name cannot be converted into the IP address. 	<ul style="list-style-type: none"> Enter the IP address, host name or URL of the destination correctly. (☞ P223 [Setting Distribution])
Multicast Is Not Supported	An IP multicast address was set.	Use an IP address that is not a multicast address.
Cannot Connect to Receiver	Establishment of connection with TCP failed.	<ul style="list-style-type: none"> Ensure that the recipient's device is set to TCP. Set Type to "MPEG2-TS/UDP". (☞ P223 [Setting Distribution])
TCP Disconnected	TCP connection is lost.	Check to ensure that there is no abnormality in the decoder, or network connection device and cables, followed by establishing the connection again.
Not Enough Bandwidth	<ul style="list-style-type: none"> The communication bandwidth is narrower than the average bit rate. The network bandwidth is insufficient, and packets are discarded. 	<ul style="list-style-type: none"> Lower the resolution/picture quality of the video to be distributed. Consider switching to the use of a stable network, such as wired LAN.
Connection Timeout	Timeout for connection via ZIXI.	Set [Destination Address] and [Destination Port] correctly. (☞ P223 [Setting Distribution])
Authorization Failed	Authentication of connection via ZIXI failed.	Set [Stream ID] and [Password] correctly. (☞ P223 [Setting Distribution])
Connection Error	Connection via "ZIXI" or "RTMP" failed.	<ul style="list-style-type: none"> Check whether a different camera with an identical stream ID is connected. Set [Destination URL] and [Stream Key] correctly. (☞ P146 [Destination URL]) (☞ P147 [Stream Key])
Disconnected	"ZIXI" or "RTMP" connection is lost.	Check whether there is abnormality with the network connection device, cables, etc., and try to re-establish the connection.

Blinking of the Tally Lamp

The tally lamp starts blinking when the remaining space on the recording media is running out during recording or when the battery power is running low.

Blinking Mode	Remaining Battery Power/SD Card Space
Blinks slowly (once every second)	<ul style="list-style-type: none">● Battery power is low● Remaining recording time on recording media is less than 3 minutes (during recording)● When a malfunction occurred during live streaming
Blinks quickly (2 times per second)	<ul style="list-style-type: none">● Remaining battery power is almost zero● Remaining recording time on recording media has reached 0 minutes (during recording)● Error on the camera recorder

Warning Tone

- Warning tone is output from the speaker and [PHONE] terminal when the battery level is low. Warning tone is also output when an error occurs in the camera recorder.

Memo : _____

- Whether the sound is to be muted or output when it is at the minimum level can be configured in [Min. ALARM Level].
( P141 [Min. ALARM Level])

Troubleshooting

Symptom	Action
Power does not turn on.	<ul style="list-style-type: none"> • Is the AC adapter properly connected? • Is the battery charged? • Is the power turned on immediately after it is turned off? Make sure to wait for an interval of at least 5 seconds before turning on the power again.
Unable to start recording.	<ul style="list-style-type: none"> • Is the write-protect switch of the SD card turned on? Make sure that the write-protect switch is turned off. (☞ P48 [Write-Protect Switch on the SD Card]) • Is the camera recorder set to the Camera mode? Use the [CAM/MEDIA] selection button to switch to the Camera mode. (☞ P20 [Operation Modes]) • Is the SD card inserted compatible with the recording format? (☞ P57 [Selecting a Video Format]) (☞ P164 [4GB File Spanning(SDXC)])
Camera image is not output on the LCD monitor and viewfinder screen.	<ul style="list-style-type: none"> • Is the camera recorder set to the Camera mode? Use the [CAM/MEDIA] selection button to switch to the Camera mode. (☞ P20 [Operation Modes])
Camera image is not output on the LCD monitor.	<ul style="list-style-type: none"> • Is the LCD backlight set to "Off"? Press the [B.LIGHT] button to switch the mode. (☞ P42 [Adjusting the LCD Monitor])
Camera image is not output on the viewfinder screen.	<ul style="list-style-type: none"> • Is the CONTRAST knob on the viewfinder set to the minimum? Adjust the [CONTRAST] knob on the viewfinder. (☞ P42 [Adjusting the Viewfinder])
Playback does not start after selecting a clip thumbnail and pressing the [STATUS/SET] button (●).	<ul style="list-style-type: none"> • Is the selected clip a playable clip? Playback is not possible if the clip has a different video format setting.
Images on the LCD monitor and viewfinder screen appear dark or blurred.	<ul style="list-style-type: none"> • Readjust the brightness of the LCD monitor and viewfinder. • Is the [ND FILTER] switch set to "1/64"? • Is the iris closed? • Is the shutter speed setting too high? • Is the peaking level too low? For the LCD monitor, adjust the outline with [LCD/VF] → [LCD Peaking]. For the viewfinder, adjust the outline with the [PEAKING] knob on the viewfinder. CHU CHE (☞ P42 [Adjusting the LCD Monitor]) (☞ P42 [Adjusting the Viewfinder])

Symptom	Action
The [CH-1/CH-2] recording level adjustment knob does not work.	<ul style="list-style-type: none"> Is the [AUDIO SELECT CH1/2]-[MANUAL/AUTO] selection switch set to "AUTO"? Is Full Auto enabled? Is [Camera Function] → [Full Auto] → [Audio] set to "Auto" in Full Auto mode? (☞ P117 [Full Auto Item])
[CH-3/CH-4] audio is not recorded.	<ul style="list-style-type: none"> Is the number of recording channels set to "4ch"? Set [System] → [Record Set] → [A Audio]/[B Audio] to "4ch". (☞ P162 [A Audio/ EXT Audio])
Microphone audio cannot be heard through the headphone.	<ul style="list-style-type: none"> Is the audio setting configured to "IFB/RET Only"? Set [A/V Set] → [Audio Set] → [IFB/RET Monitor] to "Off". (☞ P141 [IFB/RET Monitor...])
SD card cannot be initialized (formatted).	<ul style="list-style-type: none"> Is the write-protect switch of the SD card turned on? Make sure that the write-protect switch is turned off. (☞ P48 [Write-Protect Switch on the SD Card])
Battery alarm appears even after loading a charged battery.	<ul style="list-style-type: none"> Is the battery too old?
The time code and user's bit are not displayed.	<ul style="list-style-type: none"> Even in Camera mode or Media mode, the time code and user's bit may not be displayed depending to the type of display. Is [LCD/VF] → [Display On/Off] → [TC/UB] set to "Off"? To display the date and time, set it to "On". (☞ P133 [Display On/Off Item])
The time is not displayed.	<ul style="list-style-type: none"> The time is only displayed on the display screen in the Camera mode (during shooting). (☞ P170 [Display Screen in Camera Mode]) Is [System] → [Record Set] → [Time Stamp] set to "On"? To display the date and time, set it to "Off". (☞ P165 [Time Stamp])
The actual recording time is shorter than the estimated time.	<ul style="list-style-type: none"> The recordable time may be shorter depending on the shooting conditions or the subject.
The two camera recorders are not synchronized even though the time codes have been synchronized. (L on the Slave device is not displayed.)	<ul style="list-style-type: none"> Is the [TC GEN] switch set to "F-RUN"? (☞ P80 [Synchronizing the Time Code with an External Time Code Generator]) Set [System] → [Record Set] → [Record Format] → [A Frame Rate] such that the two camera recorders have the same frame rate. (☞ P161 [A Frame Rate/ EXT Frame Rate])
Cannot connect to wireless LAN.	<ul style="list-style-type: none"> Check the mode of connection and method of setting ([SSID] and [Passphrase] in cases other than WPS). (☞ P196 [Connecting to Network via [HOST] Terminal (USB)]) (☞ P197 [Connecting to Network via Built-in Wireless LAN CHU CHE]) Even if the Passphrase is wrong, "Completed the Setup Wizard. Please Input the Passphrase into Your Device." may appear at the browser setting depending on the type of encryption. Adjust [Passphrase] again. Set [Network] → [Connection Setup] → [Default Gateway] to a value other than "LAN". (☞ P145 [Default Gateway])

Symptom	Action
The View Remote screen turns black. The screen flickers. The screen freezes. Cannot perform remote operation.	<ul style="list-style-type: none"> • The network path is congested. Wait a while before refreshing (reloading) the web browser. • Clear the cache in your Web browser.
The clips cannot be uploaded to the FTP server.	<ul style="list-style-type: none"> • Adjust the [Clip Server] settings. (☞ P154 [Clip Server]) • If a file size limit is set in the FTP server, set the size limit such that it is larger than the maximum size of the recorded clip. • Take necessary action as described in "[List of FTP Transfer Errors] (☞ P 239)".
The wireless LAN is disconnected.	<ul style="list-style-type: none"> • The wireless LAN may be disconnected depending on the environment. Change the usage environment. • Connect via wired LAN. (☞ P195 [Connecting to Network via [LAN] Terminal])
The images and audio sound during live streaming are choppy.	<ul style="list-style-type: none"> • Depending on the connection method to the network and connection environment, streaming may not be possible with the encoding bit rate specified. Please reduce the encoding bit rate.
GPS signal cannot be received. CHU CHE	<ul style="list-style-type: none"> • Signal reception from GPS satellites may be affected by buildings or trees. Perform positioning preferably at an unobstructed location with a clear view. • Radio wave reception may be affected by weather conditions such as on a cloudy or rainy day.
The position is not accurate. CHU CHE	<ul style="list-style-type: none"> • The precision error may be up to hundreds of meters if the GPS signal is weak or reflected off surrounding buildings.

Specifications

Terminal Section

General

Item	Description
Power	When using an external power source: DC 11.0 V to 17.0 V When using a battery: DC 14.4 V (Anton/Bauer, IDX)
Power consumption	Approx. 38 W (during single recording at factory default settings while using the viewfinder) Approx. 33 W (When using only the camera body during single recording at factory default settings)
Mass	CHU : Approx. 5.1 kg (*1) CHE : Approx. 5.2 kg (*1) STU : Approx. 4.3 kg (*2) RCHE : Approx. 4.4 kg (*2)
Allowable operating temperature	0 °C to 40 °C (32 °F to 104 °F)
Allowable operating humidity	30 %RH to 80 %RH
Allowable storage temperature	-20 °C to 50 °C (-4 °F to 122 °F)
Drip-proof performance	Equivalent to IPX2
Built-in wireless LAN	IEEE802.11a/b/g/n/ac (2.4 GHz/5 GHz band) Encryption method: WPA2
CHU CHE	
CHU 2.4 GHz	Ch1, 2, 3, 4, 5, 6, 7, 8, 9, 10, 11
5 GHz USA	Ch36, 40, 44, 48, 52, 56, 60, 64, 100, 104, 108, 112, 116, 120, 124, 128, 132, 136, 140, 149, 153, 157, 161, 165
5 GHz CANADA	Ch36, 40, 44, 48, 52, 56, 60, 64, 100, 104, 108, 112, 116, 132, 136, 140, 149, 153, 157, 161, 165
CHE 2.4 GHz	Ch1, 2, 3, 4, 5, 6, 7, 8, 9, 10, 11, 12, 13
5 GHz Outside Russia	Ch36, 40, 44, 48, 52, 56, 60, 64, 100, 104, 108, 112, 116, 120, 124, 128, 132, 136, 140
5 GHz Russia	Ch36, 40, 44, 48, 52, 56, 60, 64, 132, 136, 140, 149, 153, 157, 161, 165

*1 Camera body and Viewfinder

*2 Camera body only

Video/Audio

Item	Description
[HD/SD SDI IN] terminal	
3G-SDI, HD-SDI	Compliant with SMPTE ST424, Compliant with SMPTE ST292
3G-SDI, HD-SDI, Embedded audio standard	Compliant with SMPTE ST299, Compliant with SMPTE ST299
[HD/SD SDI OUT 1/2] terminal (480i or 576i: Downconverted 720p/1080i/1080p: embedded audio), BNC (unbalanced)	
3G-SDI, HD-SDI, SD-SDI	Compliant with SMPTE ST424, Compliant with SMPTE ST292, Compliant with SMPTE ST259
3G-SDI, HD-SDI, SD-SDI, Embedded audio standard	Compliant with SMPTE ST299, Compliant with SMPTE ST299, Compliant with SMPTE ST272
[HDMI] output terminal	Type A
[VIDEO OUT] terminal (BNC)	Composite Video 1.0 V (p-p), 75 Ω (unbalanced)
[VF] terminal	26-pin
[MIC IN] terminal (XLR 5-pin)	-50 dBu, 4 kΩ, XLR (balanced), +48 V output (phantom power supply)
[AUDIO INPUT1/INPUT2] terminal (XLR 3-pin)	
[MIC]	-60 dBu, 4 kΩ, XLR (balanced), +48 V output (phantom power supply)
[LINE]	+4 dBu, 10 kΩ, XLR (balanced)
[AUDIO OUT] terminal (XLR 5-pin)	0 dBu, 100 Ω, XLR (balanced)
[PHONE] terminal	Φ3.5 mm stereo mini jack

Others

Item	Description
[LAN] terminal (RJ-45)	100BASE-TX/1000BASE-T
[HOST] terminal	USB-A type, network connection function only
[REMOTE] terminal	miniDin 6-pin
[TC IN] terminal	1.0 V(p-p) to 4.0 V(p-p) high impedance
[TC OUT] terminal	2.0 ± 1.0 V (p-p) low impedance
[LENS] terminal	12pin
[DC INPUT] terminal	XLR 4-pin
[DC OUT] terminal (rear)	4-pin, DC 11.0 V to 17.0 V, 1.8 A CHU STU RCHE 4-pin, DC 11.0 V to 17.0 V, 1.5 A CHE
[DC OUT] (LAN) terminal	4-pin, DC 11.0 V to 17.0 V, 0.5 A CHU STU RCHE 4-pin, DC 11.0 V to 17.0 V, 0.2 A CHE
[LIGHT] terminal	D-tap (DC 12 V, max. 50 W CHU STU RCHE) (DC 12 V, 2 A CHE)
[GENLOCK] terminal	1.0 V (p-p), 75 Ω
Wireless audio slot	UniSlot 2ch, -40 dBu (balanced)
Expansion slot	For future expansion

Camera Section

Item	Description
Image pickup device	2/3-inch, 2.2 megapixels, progressive CMOS x 3
Lens Mount	2/3-inch B4 Bayonet mount system
Color separation prism	F1.4, 3-color separation prism
Sensitivity	F12, 2000 lx (standard value: 60 Hz)
Sync system	External/Internal Synchronization (Built-in SSG)
ND filter	CLEAR, 1/4, 1/16, 1/64
Gain	-6 dB, -3 dB, 0 dB, 3 dB, 6 dB, 9 dB, 12 dB, 15 dB, 18 dB, 21 dB, 24 dB, 27 dB, 30 dB, Lolux (24 dB, 30 dB, 36 dB, 42 dB), AGC
Electronic shutter	1/3 to 1/10000, EEI
LCD Monitor	3.5-inch LCD QHD (960 × 540)
Viewfinder CHU CHE	3.26-inch OLED WVGA (854 × 480)

Storage Section

Item	Description
Supported media	SDHC/SDXC
Slots	x 2

Video/Audio

Item	Description
HD mode (MOV/MXF: MPEG-2)	
Recording file format	QuickTime File Format (MOV), MXF File Format (MXF)
Video	
HQ mode	MPEG-2 Long GOP VBR, 35 Mbps (Max) MP@HL, 1920x1080/59.94i, 29.97p, 50i, 25p 1440x1080/59.94i, 50i 1280x720/59.94p, 50p
SP mode	MPEG-2 Long GOP CBR, 25 Mbps (Max) MP@H14 1440x1080/59.94i, 50i
Audio	LPCM 2ch/4ch, 48 kHz/16 Bit
HD mode (MOV: H.264)	
Recording file format	QuickTime File Format
Video	
 XHQ mode	MPEG-4 AVC/H.264, 70 Mbps (Max) 1920x1080/59.94p, 50p MPEG-4 AVC/H.264, 50 Mbps (Max) 1920x1080/59.94p, 59.94i, 29.97p, 23.98p, 50p, 50i, 25p 1280x720/59.94p, 50p
XHQ mode	MPEG-4 AVC/H.264, 50 Mbps (Max) 1920x1080/59.94p, 59.94i, 29.97p, 23.98p, 50p, 50i, 25p
UHQ mode	MPEG-4 AVC/H.264, 35 Mbps (Max) 1920x1080/59.94i, 29.97p, 23.98p, 50i, 25p 1280x720/59.94p, 50p
Audio	LPCM 2ch/4ch, 48 kHz/16 Bit, 24 Bit (422 10 bit only)

Item	Description
HD mode (Exchange (U model) / MP4 (E model): H.264)	
Recording file format	MP4 File Format
Video	
LP mode	MPEG-4 AVC/H.264, 12 Mbps (Max) 1920x1080/59.94p (U model), 1920x1080/50p (E model), MPEG-4 AVC/H.264, 8 Mbps (Max) 1280x720/59.94p (U model) 1280x720/50p (E model)
Audio	AAC 2ch, 48 kHz/16 Bit 128 kbps
HD mode (High-Speed)	
Recording file format	QuickTime File Format
Video	
 XHQ mode	MPEG-4 AVC/H.264, 70 Mbps (Max), 1920x1080 119.88/59.94p, 100/50p MPEG-4 AVC/H.264, 50 Mbps (Max), 1920x1080 119.88/59.94p, 100/50p, 119.88/29.97p, 100/25p, 119.88/23.98p
XHQ mode	MPEG-4 AVC/H.264, 50 Mbps (Max), 1920x1080 119.88/59.94p, 100/50p, 119.88/29.97p, 100/25p, 119.88/23.98p
UHQ mode	MPEG-4 AVC/H.264, 35 Mbps (Max), 1920x1080 119.88/29.97p, 100/25p, 119.88/23.98p
Audio	LPCM 2ch, 48 kHz/16 Bit, 24 Bit (422 10 bit only)

Item	Description
SD mode (MOV: H.264)	
Recording file format	QuickTime File Format
Video	MPEG-4 AVC/H.264, 8 Mbps (Max) 720×480/59.94i (U model) 720×576/50i (E model)
Audio	LPCM 2ch, 48 kHz/16bit
Web mode (MOV: H.264)	
Recording file format	QuickTime File Format
Video	
HQ mode	MPEG-4 AVC/H.264, 8 Mbps (Max) 720×480/59.94i, 720×576/50i MPEG-4 AVC/H.264, 3 Mbps (Max) 960×540/29.97p, 25p, 23.98p
LP mode	MPEG-4 AVC/H.264, 1.2 Mbps (Max) 480×270/29.97p, 25p, 23.98p
Audio	LPCM 2ch/4ch, 48 kHz/16 Bit (720×480, 720×576) μ-law 2ch/4ch, 16 kHz (960×540, 480×270)
Streaming mode	
Video	MPEG-4 AVC/H.264 1920×1080/59.94p, 50p 24/20/16/12/8 Mbps (Max) 1920×1080/59.94i, 50i, 29.97p, 25p 20/16/12/8/5/3 Mbps (Max) 1280×720/59.94p, 50p 20/16/12/8/5/3 Mbps (Max) 1280×720/29.97p, 25p 8/5/3/1.5 Mbps (Max) 720×480/59.94i (U model) 720×576/50i (E model) 8/5/3/1.5/0.8/0.3 Mbps (Max) 640×360/59.94p, 50p 3/1.5 Mbps (Max) 640×360/29.97p, 25p 3/1.5/0.8/0.3 Mbps (Max)
Audio	AAC 2ch, 128/64 kbps

Accessories

Accessories	
Warranty Card CHU STU	1
INSTRUCTIONS (BASIC)	1
Electronic Viewfinder CHU CHE	1
Cold Shoe Unit	1
Screw (M2)	4
Wireless LAN Antenna CHU CHE	2
Core filter (large x 1, small x 1) CHE	2

* Eyepiece and body cap are attached to the camera recorder.

Dimensional Outline Drawing (Unit: mm)

Wireless LAN antenna and viewfinder are not included in GY-HC900STU and GY-HC900RCHE.

For U Model

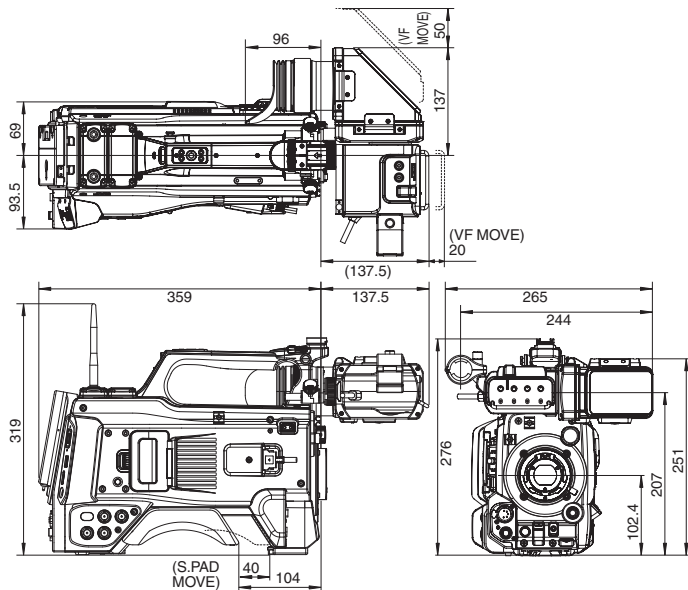

For E Model

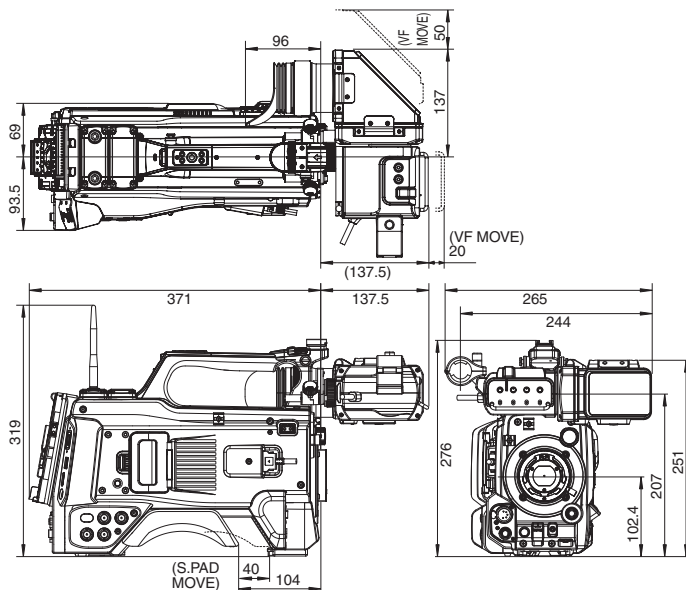

* The specifications and appearance of this product are subject to changes for further improvement without prior notice.

Appendix

Tone Mapping Characteristics for Converting HLG to ITU709 for LCD/VF

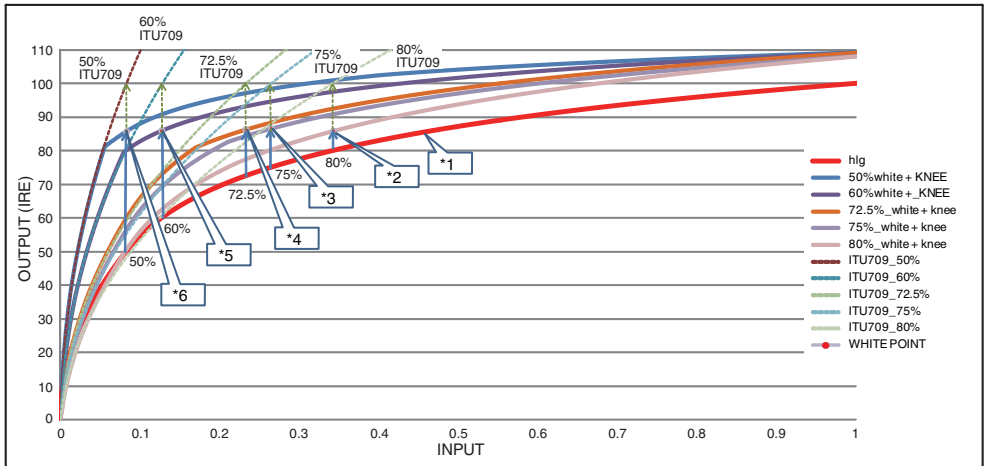

- *1 HLG
- *2 White Level
80% converted
- *3 White Level
75% converted
- *4 White Level
72.5% converted
- *5 White Level
60% converted
- *6 White Level
50% converted

Index

- A** AC adapter 33, 34
 - Action 99
 - Aspect ratio 58
- B** Backup rec 90
 - Battery 17, 34
 - Brightness adjustment 60
- C** Camera control function 212
 - Camera mode 21, 40, 170
 - Clip continuous rec 93
 - Clip cutter trig (splitting clips) 96
 - Clip name 53, 98
 - Clip review 86
 - Color bar 182
 - Color matrix 183
 - Connection settings file 217
 - Continuous operating time 34
- D** Deleting clips 102
 - Display screen 40, 170, 176
 - Dual rec 88
- E** Electronic shutter 63
 - Error message 68, 237
 - Expanded focus 60
 - External monitor 188
- F** Favorites menu 166
 - FAW (Full Auto White Balance) . 65, 112, 115
 - FEC Matrix 226
 - File format 56
 - Focus 59
 - Focus assist 59
 - Formatting (initializing) SD cards 51
 - Frame rec 94
 - FTP Resume 204
 - FTP server 100, 198, 200
- G** Gain adjustment 62
 - Genlock 191
 - GPS 85, 157
- H** Headphone 190
 - Histogram 87, 130
- I** Initial settings 38
 - Interval rec 95
 - Iris adjustment 61
- L** LCD monitor 17, 36, 40, 42
 - Live streaming 220
- M** Marker display 181
 - Media mode 21, 40, 176
 - Menu 107, 108, 110
 - Metadata 198, 205
- N** ND filter 22
 - Network 143, 194
 - Network operating environment 195
- O** OK mark 103
 - Operation lock 54
- P** Picture quality setting 70
 - Power 36, 37
 - Pre rec 92
- R** Recordable time 47
 - Remote edit mode 21, 41
 - Resolution 56
 - Restoring SD card 52
 - Return Audio 228
 - Return over IP 149, 227
 - Return Video ... 116, 134, 136, 138, 193, 228
- S** Safety zone display 181
 - SD/SDHC/SDXC card 18, 47
 - SDI 188
 - Selecting multiple clips 104
 - Series rec 88
 - Setting the date/time 39
 - Setup file 185
 - Shooting 55
 - Software keyboard 109
 - Spot meter 83
 - Status screen 41, 179
 - Switching shutter speed 63
- T** Tally lamp 46, 242
 - Thumbnail (detailed screen) 99
 - Thumbnail (standard screen) 97
 - Thumbnail screen 97
 - Time code 75, 76
 - Time code generator 76
 - Time code playback 101
 - Trimming 106
- U** User button 45
 - User's bit 75
- V** Video format 56
 - View remote 212
 - Viewfinder 17, 36, 40, 42

W	Warning	41, 242
	Web browser	204, 209, 214
	White balance adjustment	65
	White paint	68
	Wired LAN	195
	Wireless LAN	32, 196, 197
	Wizard	144, 195, 196, 197
Z	Zebra pattern	82
	Zoom	59

Software License Agreement

The software embedded in the Product (hereinafter the “Licensed Software”) provided by JVCKENWOOD Corporation (hereinafter the “Licensor”) is copyrighted to or sublicenseable by the Licensor, and this Agreement provides for the terms and conditions which Users shall follow in order to use the Licensed Software. The User shall use the Licensed Software by agreeing with the terms of this Software License Agreement. This Agreement shall be deemed completed at the time the User (hereinafter the “User”) initially used the Product in which the “Licensed Software” is embedded. The Licensed Software may include the software which has been licensed to the Licensor directly or indirectly from any third party. In such case, some third parties require the Users to follow their conditions for use separately from this Software License Agreement. Such software shall not be subject to this Agreement, and the Users are urged to read the “[Important Notice concerning the Software] (P 255)” to be provided separately.

Article 1 General Provision

The Licensor shall grant to the User a non-exclusive and non-transferable (other than the exceptional case referred to in Article 3, Paragraph 1) licensed to use the Licensed Software within the country of the User (the country where the User bought the Product (hereinafter the “Country”)).

Article 2 License

1. The license granted under this Agreement shall be the right to use the Licensed Software in the Product.
2. The User shall not duplicate, copy, modify, add, translate or otherwise alter, or lease the Licensed Software and any related documents, whether in whole or in part.
3. The use of the Licensed Software shall be limited to personal purpose, and the Licensed Software shall not be distributed, licensed or sub-licensed whether it is for commercial purpose or not.
4. The User shall use the Licensed Software according to the directions described in the operation manual or help file, and is prohibited to use or duplicate any data in a manner violating the Copyright Law or any other laws and regulations by applying whole or a part of the Licensed Software.

Article 3 Conditions for Grant of License

1. When the User transfers the Product, it may also transfer the license to use the Licensed Software embedded in the Product (including any related materials, updates and upgrades) on condition that no original, copies or related materials continue in the possession of the User, and that the User shall cause the transferee to comply with this Software License Agreement.
2. The User shall not carry out reverse engineering, disassembling, decompiling or any other code analysis works in connection with the Licensed Software.

Article 4 Right pertaining to the Licensed Software

1. Any and all copyrights and other rights pertaining to the Licensed Software and related documents shall belong to the Licensor or the original holder of the right who granted to the Licensor the license or sublicense for the Licensed Software (hereinafter the “Original Rightholder”), and the User shall not be entitled to any right other than the license granted hereunder, in respect of the Licensed Software and any related documents.
2. The User shall, whenever the User uses the Licensed Software, comply with any laws relating to the copyright and other intellectual property rights.

Article 5 Indemnification of Licensor

1. Neither the Licensor nor the Original Rightholder shall be liable for any damage incurred by the User or any third party due to the exercise of the license granted to the User under this Agreement, unless otherwise restricted by law.
2. The Licensor will offer no guarantee for the merchantability, convertibility and consistency with certain objective of the Licensed Software.

Article 6 Liability to Third Party

If any dispute has arisen with any third party due to an infringement upon a copyright, patent or any other intellectual property right that was caused by the User’s use of the Licensed Software, the User shall settle such dispute at the User’s own cost and hold the Licensor and the Original Rightholder harmless from any inconvenience it may cause.

Article 7 Confidentiality

The User shall keep the confidentiality of such portion of the Licensed Software, related documents thereof or any other information to be granted under this Agreement, as well as the conditions of this Agreement as has not yet entered the public domain, and shall not disclose or divulge the same to any third party without approval of the Licensor.

Article 8 Termination

In case the User falls under any of the events described in the following items, the Licensor may immediately terminate this Agreement or claim that the User compensates for the damage incurred by the Licensor due to such event:

- (1) when the User violated any provision of this Agreement; or
- (2) when a petition has been filed against the User for an attachment, provisional attachment, provisional disposition or any other compulsory execution.

Article 9 Destruction of the Licensed Software

If this Agreement is terminated pursuant to the provision of Article 8, the User shall destroy the Licensed Software, any related documents and copies thereof within two (2) weeks from such date of termination.

Article 10 Export Restriction

1. The User shall understand that the Licensed Software shall be subject to the export restrictions adopted by the country of User and any other countries.
2. The User shall agree that the software will be subject to any and all applicable international and domestic laws including the export control regulation of the country of User and any other countries, and any restrictions concerning the end-users, the use by end-users and importing countries to be provided by the country of User and any other countries, and any other governmental authorities.
3. If the User is an agency of the United States of America (the "Government"), the User acknowledge Licensor's representation that the Licensed Software is a "Commercial Item" as defined in Federal Acquisition Regulation (FAR) part 2.101(g) consisting unpublished "Commercial Computer Software" as those items are used at FAR part 12.212 and is only license the User with the same use right Licensor grants all commercial end users pursuant to the terms of this Agreement.

Article 11 Miscellaneous

1. In the event any part of this Agreement is invalidated by operation of law, the residual provisions shall continue in force.
2. Matters not stipulated in this Agreement or any ambiguity or question raised in the construction of this Agreement shall be provided or settled upon good-faith consultation between the Licensor and the User.
3. The Licensor and the User hereby agree that this Agreement is governed by the laws of Japan, and any dispute arising from, and relating to the rights and obligations under, this Agreement shall be submitted to the exclusive jurisdiction of the Tokyo District Court for its first instance.

Important Notice concerning the Software

Software License Attached to the Product :

The Software embedded in the Product is composed of several independent software components, and in each of such individual components (hereinafter the "Licensed Software"), a copyright of either JVCKENWOOD Corporation (hereinafter "JKC") or a third party subsists.

The Product uses the software component designated in the End-User License Agreement that was executed between JKC and a third party (hereinafter "EULA").

The Licensed Software covers those corresponding to free software, and, as a condition of distribution of the software component in executable format which is based on the license granted under the GNU General Public License or Lesser General Public License (hereinafter "GPL/LGPL"), it requires an availability of the source code for the relevant component. Please refer to the following URL concerning the distribution of the source code;

<https://www3.jvckenwood.com/english/download/gpl/index.html>

Please note that we are unable to answer any inquiry relating to the contents, etc. of the source code. In addition, the Licensed Software includes the software developed or created independently by JKC and there exists an ownership of JKC in such software and any accompanying documents, which is protected by the Copyright Law, any international treaties and other applicable laws. As to matters concerning the handling by JKC of the software components, please refer to the "Software License Agreement" attached hereto. Please note that any software component licensed under "EULA" which is not subject to "GPL/LGPL", and those developed or created independently by JKC shall not be subject to the requirement for provision of the source code. The software component distributed under "GPL/LGPL" shall be licensed to users without charge, and, therefore, no warranty is given for such software component, either express or implied, within the scope of the applicable laws and regulations. Unless otherwise permitted by applicable laws and regulations or agreed in written form, none of the owners of the copyright or persons entitled to alter or redistribute the software component under the said license shall have any liability for any type of damage or loss resulting from the use of or inability to use such software component. For further details of the conditions of use of such software component or matters required to be complied with, please refer to the relevant "GPL/LGPL".

Users are urged to read the details for the relevant license carefully before using the software component covered by "GPL/LGPL" and embedded in the Product. Since the terms and conditions of individual licenses are provided by parties other than JKC, the original English version will be displayed by the Product.

- ① Turn on the power.
- ② Press the [MENU/THUMB] button.
- ③ Select [System] → [System Information] → [Open Source License].

GY-HC900CHU/GY-HC900CHE
GY-HC900STU/GY-HC900RCHE
HD MEMORY CARD CAMERA RECORDER

JVC