

# JVC

## USER MANUAL

DLP PROJECTOR

---

# LX-NZ3

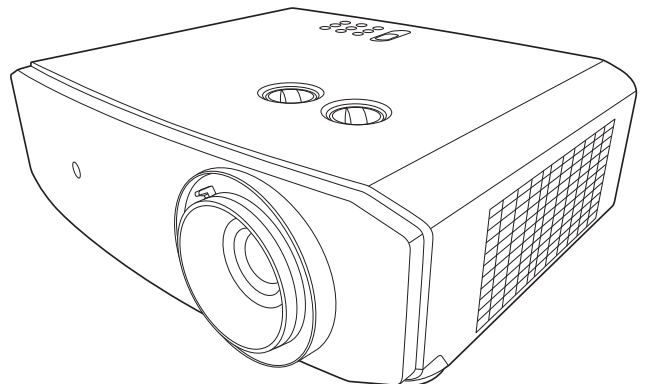

**HDMI**™  
HIGH DEFINITION MULTIMEDIA INTERFACE

# Table of contents

Safety precautions.....	3	Light source information .....	33
Important safety instructions		Getting to know the light source hour	
.....	4	.....	33
Overview .....	9	Extending light source life.....	33
Shipping contents.....	9	Indicators .....	34
Projector exterior view.....	10	Troubleshooting .....	35
Controls and functions.....	11	Specifications.....	36
Control panel .....	11	Projector specifications.....	36
Remote control .....	12	Dimensions .....	37
Installation .....	14	Timing chart.....	38
Choosing a location.....	14	Warranty and Copyright	
Obtaining a preferred projected		information.....	43
image size .....	15	Warranty .....	43
Connection .....	17	Copyright .....	43
Operation.....	18	Disclaimer .....	43
Starting up the projector.....	18		
Shutting down the projector.....	18		
Selecting an input source .....	19		
Adjusting the projected image ...	20		
Adjusting the projection angle .....	20		
Fine-tuning the image size and clarity			
.....	20		
Correcting keystone.....	20		
Menu Functions.....	21		
About the OSD Menus .....	21		
Using the OSD menu .....	21		
<b>PICTURE</b> menu.....	22		
<b>DISPLAY</b> menu .....	25		
<b>INSTALLATION</b> menu .....	26		
<b>SYSTEM SETUP: Basic</b> menu .....	27		
<b>SYSTEM SETUP: Advanced</b> menu			
.....	28		
<b>INFORMATION</b> menu .....	28		
OSD menu structure.....	30		
Maintenance .....	32		
Care of the projector.....	32		

# Safety precautions

## **FCC INFORMATION (U.S.A. only)**

### **CAUTION:**

Changes or modification not approved by JVCKENWOOD Corporation could void the user's authority to operate the equipment.

### **NOTE:**

This equipment has been tested and found to comply with the limits for Class B digital devices, pursuant to Part 15 of the FCC Rules. These limits are designed to provide reasonable protection against harmful interference in a residential installation. This equipment generates, uses, and can radiate radio frequency energy and, if not installed and used in accordance with the instructions, may cause harmful interference to radio communications. However, there is no guarantee that interference will not occur in a particular installation. If this equipment does cause harmful interference to radio or television reception, which can be determined by turning the equipment off and on, the user is encourage to try to correct the interference by one or more of the following measures:

- Reorient or relocate the receiving antenna.
- Increase the separation between the equipment and receiver.
- Connect the equipment into an outlet on a circuit different from that to which the receiver is connected.
- Consult the dealer or an experienced radio/TV technician for help.

### **Declaration of Conformity**

Model Number: LX-NZ3BG, LX-NZ3WG, LX-NZ3BK, LX-NZ3WK

Trade Name: JVC

Responsible party: JVCKENWOOD USA Corporation

Address: 500 Valley Road, Suite 203 Wayne, NJ 07470

Telephone Number: 973-317-5000

This device complies with Part 15 of the FCC Rules.

Operation is subject to the following two conditions:

(1) This device may not cause harmful interference, and (2) this device must accept any interference received, including interference that may cause undesired operation.

## **NOISE EMISSION DECLARATION**

The sound pressure level at the operator position is equal or less than 60dB(A) according to ISO7779.

Dear Customer,

This apparatus is in conformance with the valid European directives and standards regarding electromagnetic compatibility and electrical safety.

European representative of JVCKENWOOD Corporation is: JVCKENWOOD Deutschland GmbH Konrad-Adenauer-Allee 1-11, 61118 Bad Vilbel, GERMANY

## Information for Users on Disposal of Old Equipment and Batteries



Products



Battery

### [European Union only]

These symbols indicate that equipment with these symbols should not be disposed of as general household waste. If you want to dispose of the product or battery, please consider the collection systems or facilities for appropriate recycling.

**Notice:** The sign Pb below the symbol for batteries indicates that this battery contains lead.

# Important safety instructions

Your projector is designed and tested to meet the latest standards for safety of information technology equipment. However, to ensure safe use of this product, it is important that you follow the instructions mentioned in this manual and marked on the product.

1. Please read this user manual before you operate your projector. Keep this manual in a safe place for future reference.
2. Always place the projector on a level, horizontal surface during operation.
  - Do not place the projector on an unstable cart, stand, or table as it may fall and be damaged.
  - Do not place inflammables near the projector.
  - Do not use if tilted at an angle of more than 10 degrees left to right, nor at angle of more than 15 degrees front to back.
3. Do not store the projector on end vertically. Doing so may cause the projector to fall over, causing injury or resulting in damage.
4. Do not place the projector in any of the following environments:
  - Space that is poorly ventilated or confined. Allow at least 50 cm clearance from walls and free flow of air around the projector.
  - Locations where temperatures may become excessively high, such as the inside of a car with all windows closed.
  - Locations where excessive humidity, dust, or cigarette smoke may contaminate optical components, shorten the projector's lifespan and darken the screen.
  - Locations near fire alarms.
  - Locations with conditions beyond those listed in "[Projector specifications](#)".
5. Do not block the vents while the projector is on (even in standby mode).
  - Do not cover the projector with any item.
  - Do not place the projector on a blanket, bedding or any other soft surface.
6. In areas where the mains power supply voltage may fluctuate by  $\pm 10$  volts, it is recommended that you connect the projector through a power stabilizer, surge protector or uninterruptible power supply (UPS) as appropriate to your situation.
7. Do not step on the projector or place any objects upon it.

8. Do not place liquids near or on the projector. Liquids spilled into the projector will void your warranty. If the projector does become wet, disconnect it from the power outlet and contact JVCKENWOOD Corporation to have the projector repaired.
9. Do not look straight into the projector lens during operation. It may harm your sight.



RG2 IEC 62471-5:2015

10. This projector is capable of displaying inverted images for ceiling mount installation. Use only a proper ceiling mount kit for mounting.
11. THIS APPARATUS MUST BE EARTHED.
12. When installing the unit, incorporate a readily accessible disconnect device in the fixed wiring, or connect the power plug to an easily accessible socket-outlet near the unit. If a fault should occur during operation of the unit, operate the disconnect device to switch the power supply off, or disconnect the power plug.

## High temperature Caution

The temperature of the cabinet around and above the exhaust vents can become hot during projector operation. Touching these areas during operation could cause burns to the hands. Do not touch these areas. Doing so may cause burns. Pay particular attention in preventing young children from touching these parts. Additionally, do not place any metal objects on these areas. Due to the heat from the projector, doing so could cause an accident or personal injury.

## Ceiling mounting the projector

If you intend to mount your projector on the ceiling, we strongly recommend that you use a proper fitting projector ceiling mount kit and ensure it is securely and safely installed.

If not, there is a safety risk that the projector may fall from the ceiling due to an improper attachment through the use of the wrong gauge or length screws.

You can purchase a proper projector ceiling mount kit from the place you purchased your projector. We recommend that you also purchase a separate Kensington lock compatible security cable and attach it securely to both the Kensington lock slot on the projector and the base of the ceiling mount bracket. This will perform the secondary role of restraining the projector should its attachment to the mounting bracket become loose.

Do not attempt to disassemble this projector. There are dangerous high voltages inside which may cause death if you should come into contact with live parts.

Under no circumstances should you ever undo or remove any other covers. Refer servicing only to suitably qualified professional service personnel.

 **Please keep the original packing for possible future shipment. If you need to pack your projector after use, adjust the projection lens to an appropriate position, put the lens cushion around the lens, and fit the lens cushion and projector cushion together to prevent damage during transportation.**

When you think service or repair is required, take the projector only to a suitably qualified technician.

## Moisture condensation

Never operate the projector immediately after moving it from a cold location to a hot location. When the projector is exposed to such a change in temperature, moisture may condense on the

crucial internal parts. To prevent the projector from possible damage, do not use the projector for at least 2 hours when there is a sudden change in temperature.

## Avoid volatile liquids

Do not use volatile liquids, such as insecticide or certain types of cleaner, near the projector. Do not have rubber or plastic products touching the projector for a long time. They will leave marks on the finish. If cleaning with a chemically treated cloth, be sure to follow the cleaning product's safety instructions.

## Disposal

This product contains the following materials which are harmful to human bodies and environment.

- Lead, which is contained in solder.

To dispose of the product, consult your local environment authorities for regulations.

## For the customers in the U.S.A. and Canada

### CAUTION

Use the controls or adjustments or performance of procedures other than those specified herein may result in hazardous radiation exposure.

This Projector is classified as a CLASS 3R LASER PRODUCT.

This CLASS 3R LASER PRODUCT label and Caution label is located on the Rear Side surface of the projector.



Location information of the label

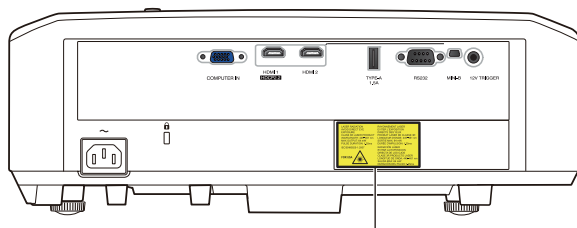

LASER CAUTION LABEL

## APERTURE LABEL



The APERTURE LABEL is located on the top cover.

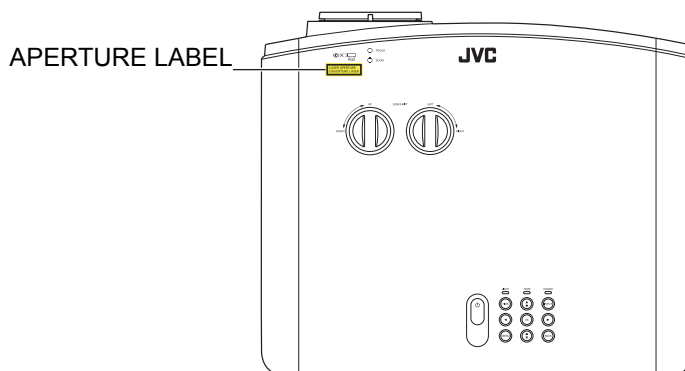

### WARNING

LASER RADIATION AVOID DIRECT EYE EXPOSURE CLASS 3R LASER PRODUCT

### CAUTION

Do not look into the lens while in use.

Light source specifications

95 W Laser diodes x 1

Wavelength 449 - 461 nm

Maximum output is 64 mW

Beam divergence angle from lens of this unit

Wide:  $\alpha = 30.3^\circ$

Tele:  $\alpha = 19.9^\circ$

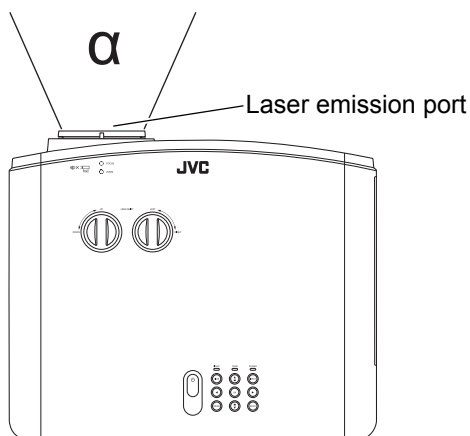

For the customers in other countries

**CLASS 1 LASER PRODUCT**

**LASER CAUTION LABEL**



### WARNING

Do not look into the lens while in use.

**CAUTION**

Use of controls or adjustments or performance of procedures other than those specified herein may result in hazardous radiation exposure.

Location information of the label

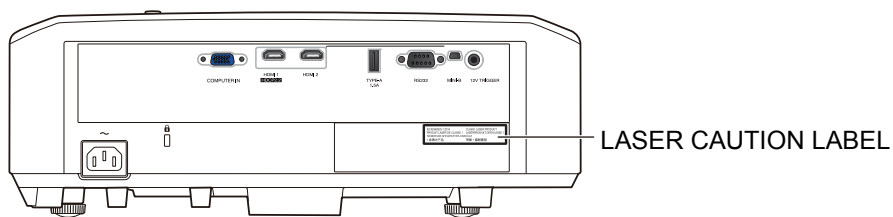

**IEC62471-5**

Location information of the icon

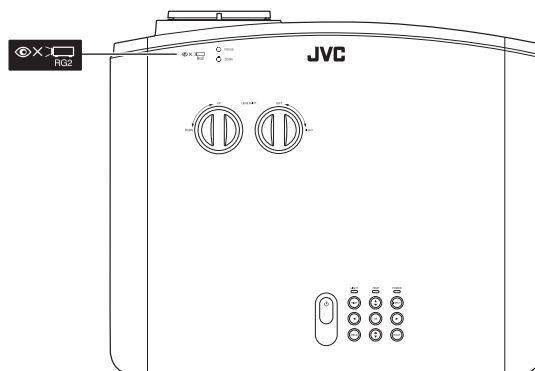

As with any bright light source, do not stare into the beam, RG2 IEC62471-5:2015



# Overview

## Shipping contents

Carefully unpack and verify that you have the items below. Some of the items may not be available depending on your region of purchase. Please check with your place of purchase.

 Some of the accessories may vary from region to region.

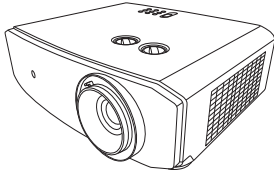

---

Projector



---

Remote control and batteries



---

User manual CD

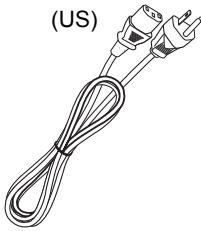

(US)

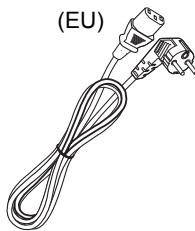

(EU)

---

Power cable\*

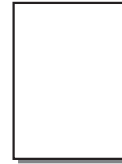

---

Quick start guide

 \*The power cable supplied is different according to regions.

# Projector exterior view

## Front and upper side view

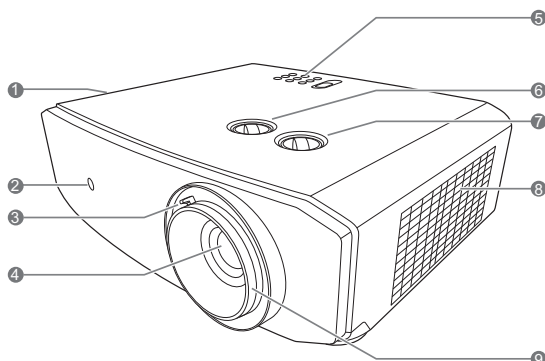

- 1. Vent (heated air exhaust)**
- 2. Front IR remote sensor**
- 3. Zoom ring**  
Adjusts the size of the projected image.
- 4. Projection lens**
- 5. Control panel (See "Control panel" for details.)**
- 6. Lens shift knob (Left/Right)**  
Adjusts the horizontal position of the projected image.
- 7. Lens shift knob (Up/Down)**  
Adjusts the vertical position of the projected image.
- 8. Vent (cool air intake)**
- 9. Focus ring**  
Adjusts the focus of the projected image.

## Rear/bottom view

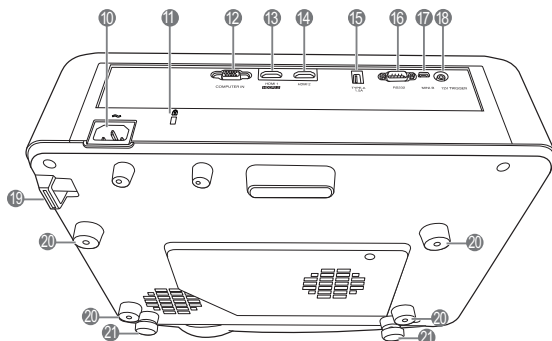

- 10. AC Power cable inlet**
- 11. Kensington lock slot**
- 12. Computer (D-Sub 15pin) input jack**
- 13. HDMI 1 port (HDCP 2.2)**
- 14. HDMI 2 port**
- 15. USB Type-A port**  
Used for charging external device.
- 16. RS-232 control port**
- 17. Mini USB port**  
Used for service.
- 18. 12VDC output terminal**  
Used to trigger external devices such as an electric screen or light control, etc.  
Consult your dealer for how to connect these devices.
- 19. Security bar**
- 20. Ceiling mount holes**
- 21. Adjuster feet**

# Controls and functions

## Control panel

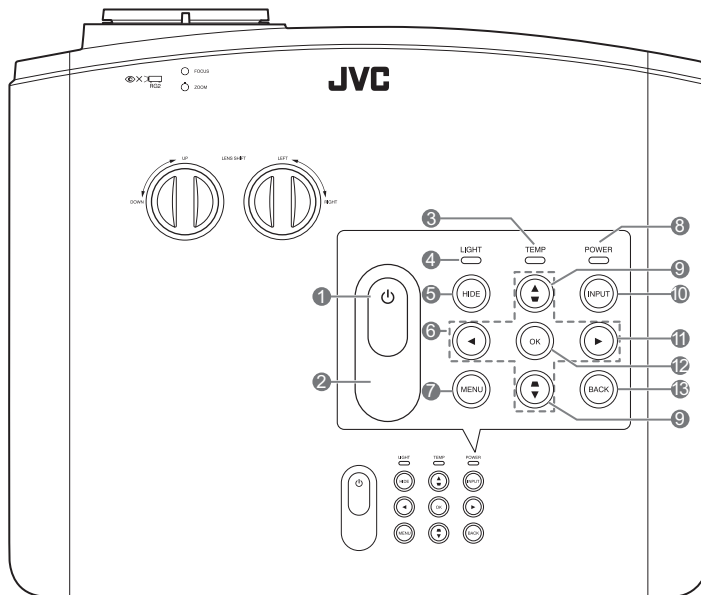

- 1. POWER**  
Toggles the projector between standby mode and on.
- 2. Top IR remote sensor**
- 3. TEMPERATURE warning light**  
Lights up red if the projector's temperature becomes too high.
- 4. LIGHT indicator light**  
Indicates the status of the light source. Lights up or flashes when the light source has developed a problem.
- 5. HIDE**  
Used to blank the screen picture. Press most of the keys on the projector or remote control to restore the picture.
- 6. Arrow keys (◀, ▲, ▶, ▼)**  
When the On-Screen Display (OSD) menu is activated, these keys are used as directional arrows to select the desired menu items and to make adjustments.
- 7. MENU**  
Displays the menu, or hides the menu if it is displayed.
- 8. POWER indicator light**  
Lights up or flashes when the projector is under operation.
- 9. Keystone keys (▼, ▲)**  
Launches the **Keystone** window. Use ▲, ▼ to manually correct distorted images resulting from an angled projection.
- 10. INPUT**  
Displays the source selection bar.
- 11. ▶**  
Activates panel key lock. To unlock the keys, press and hold ▶ for 3 seconds or setting OSD menu using the remote control.
- 12. OK**  
Activates the selected On-Screen Display (OSD) menu item.
- 13. BACK**  
Goes back to previous OSD menus, exits and saves any changes made using the On-Screen Display (OSD) menu.

# Remote control

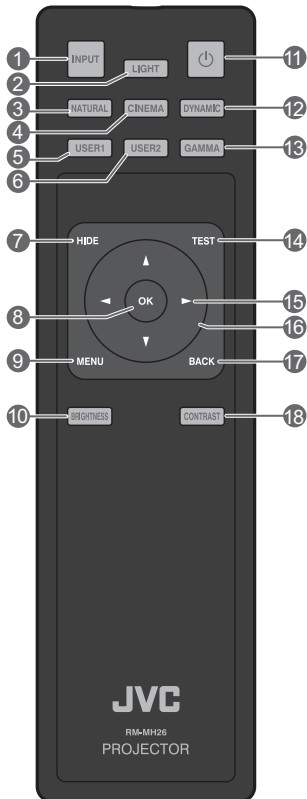

## 1. INPUT

Displays the source selection bar.

## 2. LIGHT

Turns on the remote control backlight for a few seconds. To keep the backlight on, press any other key while the backlight is on. Press the key again to turn the backlight off.

## 3. NATURAL

Selects the picture mode: **Natural**.

## 4. CINEMA

Selects the picture mode: **Cinema**.

## 5. USER1

Selects the picture mode: **User 1**.

## 6. USER2

Selects the picture mode: **User 2**.

## 7. HIDE

Used to blank the screen picture. Press most of the keys on the projector or remote control to restore the picture.

## 8. OK

Activates the selected On-Screen Display (OSD) menu item.

## 9. MENU

Displays the menu, or hides the menu if it is displayed.

## 10. BRIGHTNESS

Displays the setting bar for brightness adjustment.

## 11. POWER

Toggles the projector between standby mode and on.

## 12. DYNAMIC

Selects the picture mode: **Dynamic**.

## 13. GAMMA

Displays the **Select Gamma** menu.

## 14. TEST

Displays the test pattern.

## 15. ► Right

Activates panel key lock. To unlock the keys, press and hold ► for 3 seconds or setting OSD menu using the remote control.

## 16. Arrow keys (◀ Left, ► Right, ▲ Up, ▼ Down)

When the On-Screen Display (OSD) menu is activated, these keys are used as directional arrows to select the desired menu items and to make adjustments.

## 17. BACK

Goes back to previous OSD menu, exits and saves menu settings.

## 18. CONTRAST

Displays the setting bar for contrast adjustment.

## Installing/replacing the remote control battery

1. To open the battery cover, turn the remote control over to view its back, press on the finger grip on the cover and slide it up in the direction of the arrow as illustrated.
2. Remove any existing batteries (if necessary) and install two AA batteries observing the battery polarities as indicated in the base of the battery compartment. Positive (+) goes to positive and negative (-) goes to negative.
3. Refit the cover by aligning it with the base and pushing it back up into position. Stop when it clicks into place.

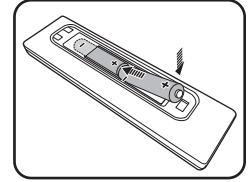
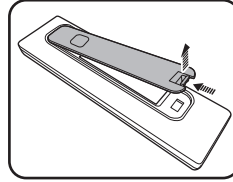

- **Avoid leaving the remote control and battery in an excessive heat or humid environment like the kitchen, bathroom, sauna, sunroom or in a closed car.**
- **Replace only with the same or equivalent type recommended by the battery manufacturer.**
- **Dispose of the used batteries according to the manufacturer's instructions and local environment regulations for your region.**
- **Never throw the batteries into a fire. There may be danger of an explosion.**
- **If the batteries are drained or if you will not be using the remote control for an extended period of time, remove the batteries to avoid damage to the remote control from possible battery leakage.**

## Remote control effective range

The remote control must be held at an angle within 30 degrees perpendicular to the projector's IR remote control sensor(s) to function correctly. The distance between the remote control and the sensor(s) should not exceed 8 meters (~ 26 feet).

Make sure that there are no obstacles between the remote control and the IR sensor(s) on the projector.

- **Operating the projector from the front**
- **Operating the projector from the top**

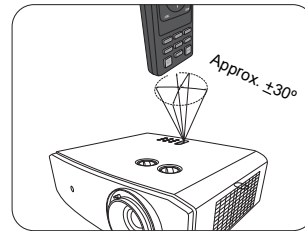
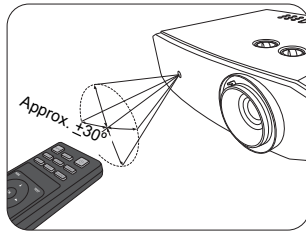



# Installation

## Choosing a location

Before choosing an installation location for your projector, take the following factors into consideration:

- Size and position of your screen
- Electrical outlet location
- Location and distance between the projector and the rest of your equipment

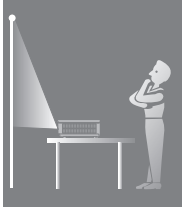
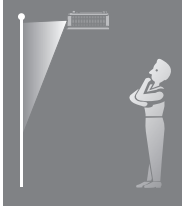
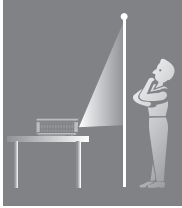
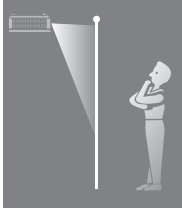
You can install your projector in the following ways.

<p><b>1. Front:</b></p> <p>Select this location with the projector placed near the floor in front of the screen.</p> <p>This is the most common way to position the projector for quick setup and portability.</p> <p>Turn on the projector and make the following settings:</p> <p><b>INSTALLATION &gt; Projector Mode &gt; Front</b></p>		<p><b>3. Front Ceiling:</b></p> <p>Select this location with the projector suspended from the ceiling in front of the screen.</p> <p>Turn on the projector and make the following settings:</p> <p><b>INSTALLATION &gt; Projector Mode &gt; Front Ceiling</b></p>		
<p><b>2. Rear:</b></p> <p>Select this location with the projector placed near the floor behind the screen.</p> <p>Turn on the projector and make the following settings:</p> <p><b>INSTALLATION &gt; Projector Mode &gt; Rear</b></p>			<p><b>4. Rear Ceiling:</b></p> <p>Select this location with the projector suspended from the ceiling behind the screen.</p> <p>Turn on the projector and make the following settings:</p> <p><b>INSTALLATION &gt; Projector Mode &gt; Rear Ceiling</b></p>	
<p> A special rear projection screen is required.</p>		<p> A special rear projection screen and a proper ceiling mount kit are required.</p>		

# Obtaining a preferred projected image size

The distance from the projector lens to the screen, the zoom setting, and the video format each factors in the projected image size. To shift the lens, turn the knobs on the projector to shift the projection lens in any direction within the allowable range depending on your desired image position

## Front projection

- When adjusting the projection position vertically in lens shift
- When adjusting the projection position horizontally in lens shift

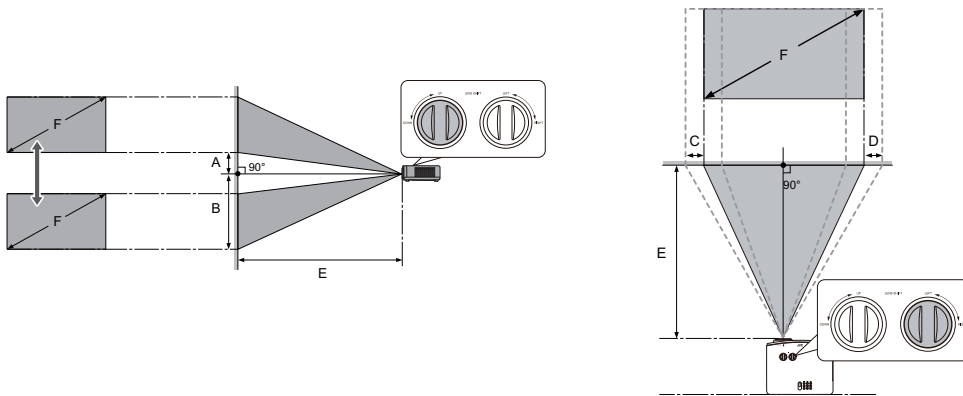

- A: Distance from the center of the lens to the bottom edge of the projected image (when lens shift is raised to its highest level)
- B: Distance from the center of the lens to the bottom edge of the projected image (when lens shift is lowered to its lowest level)
- C: Lens center movement distance (when lens shift is set to maximum left)
- D: Lens center movement distance (when lens shift is set to maximum right)
- E: Projection distance from the projector to the screen
- F: Size of the projected image

- The screen aspect ratio is 16:9 and the projected picture is in a 16:9 aspect ratio

Screen size		Size of the projected image (F)				Projection distance (E)				Offset (A)		Offset (B)		Offset (C, D)	
Diagonal		Height		Width		Shortest (Wide)		Longest (Tele)							
Inch	cm	Inch	cm	Inch	cm	Inch	cm	Inch	cm	Inch	cm	Inch	cm	Inch	cm
80	203	39	100	70	177	94	240	151	384	3.9	10	43.1	110	16.0	41
90	229	44	112	78	199	106	270	170	432	4.4	11	48.5	123	18.0	46
95	241	47	118	83	210	112	285	180	456	4.7	12	51.2	130	19.0	48
100	254	49	125	87	221	118	300	189	480	4.9	12	53.9	137	20.0	51
110	279	54	137	96	244	130	330	208	528	5.4	14	59.3	151	22.1	56
120	305	59	149	105	266	142	360	227	576	5.9	15	64.7	164	24.1	61
130	330	64	162	113	288	154	390	246	624	6.4	16	70.1	178	26.1	66
140	356	69	174	122	310	165	420	265	672	6.9	17	75.5	192	28.1	71

Screen size		Size of the projected image (F)				Projection distance (E)				Offset (A)		Offset (B)		Offset (C, D)	
Diagonal		Height		Width		Shortest (Wide)		Longest (Tele)							
Inch	cm	Inch	cm	Inch	cm	Inch	cm	Inch	cm	Inch	cm	Inch	cm	Inch	cm
150	381	74	187	131	332	177	450	283	720	7.4	19	80.9	205	30.1	76
160	406	78	199	139	354	189	480	302	768	7.8	20	86.3	219	32.1	81
170	432	83	212	148	376	201	510	321	816	8.3	21	91.7	233	34.1	87
180	457	88	224	157	398	213	540	340	864	8.8	22	97.1	247	36.1	92
200	508	98	249	174	443	236	600	378	960	9.8	25	107.9	274	40.1	102

☞ All measurements are approximate and may vary from the actual sizes. If you want a permanent installation of the projector, we recommend that you use the actual projector to physically test the projection size, distance, and the projector's optical characteristics prior to the installation. This helps you determine the exact mounting position which best suits your installation.

## The projection range for lens shift

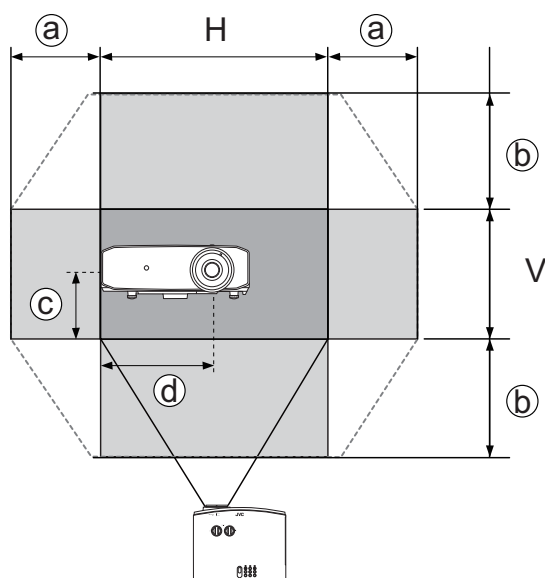

- a: Maximum horizontal range ( $H \times 23\%$ )
- b: Maximum vertical range ( $V \times 60\%$ )
- c: 1/2 the vertical height of the image
- d: 1/2 the horizontal width of the image

⚠ Be sure to stop turning the adjustment knob when you hear a clicking sound indicating that the knob has reached its limit. Over-turning the knob may cause damage.

- ☞ • You cannot move the image to both the horizontal and vertical maximum values.
- Lens shift adjustment does not result in a degraded picture quality. In the unlikely event that the image distortion is produced, see ["Adjusting the projected image"](#) for details.



# Connection

When connecting a signal source to the projector, be sure to:

1. Turn all equipment off before making any connections.
2. Use the correct signal cables for each source.
3. Make sure the cables are firmly inserted.

 In the connection illustrations shown below, cables are not included with the projector (see "[Shipping contents](#)"). They are commercially available from electronics stores.

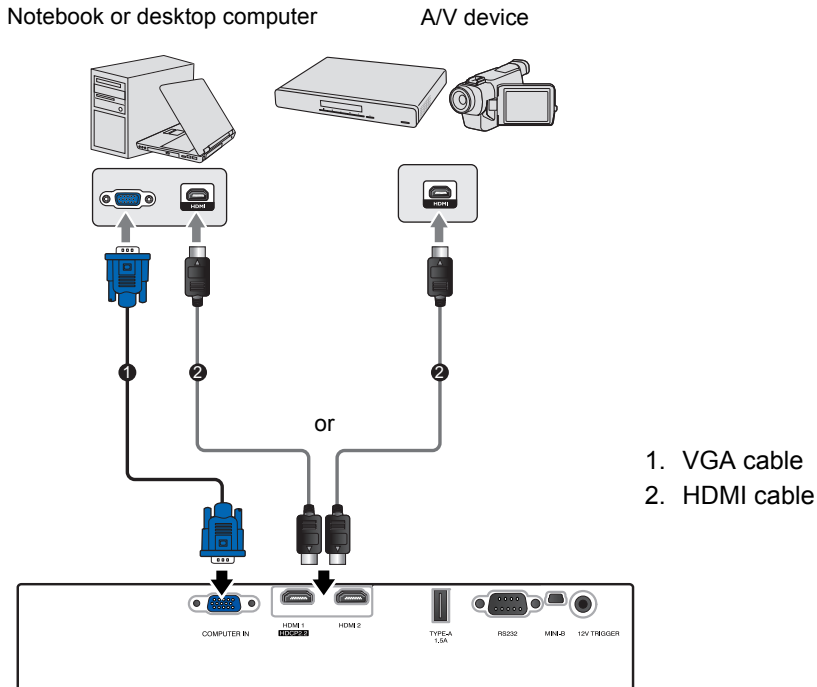

Terminal	HDCP ver.	Used for
HDMI 1	2.2	4K/HDR source
HDMI 2	1.4	Up to 4K/30Hz source

 Only HDMI 1 connector supports 4K (Ultra HD)/HDR.

 Use a certified Premium High Speed HDMI Cable (18 Gbps compatible) and connect to HDMI 1 terminal when inputting 4K video signals from an external device.

# Operation

## Starting up the projector



1. Plug the power cable into the projector and a power outlet. Turn on the power outlet switch (where fitted). The **POWER indicator light** on the projector lights orange after power has been applied.

 **Please use the supplied power cable to avoid possible dangers such as electric shock and fire.**

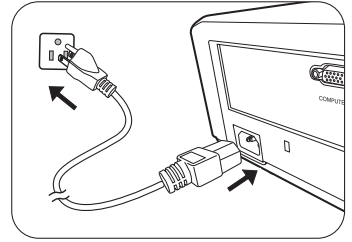
2. Press  to start the projector. The **POWER indicator light** flashes green and stays green when the projector is on. The fans start operating, and a start-up image displays on the screen while it warms up. The projector does not respond to further commands while it is warming up.



## Shutting down the projector

1. Press . The projector displays a shutdown confirmation message.
2. Press  a second time. The **POWER indicator light** flashes orange and the fans run for about two minutes to cool the light source. The projector doesn't respond to any commands during the cooling process.
3. When the cooling process ends, the **POWER indicator light** will show a solid orange. If the projector will not be used for an extended period, unplug the power cable from the power outlet.

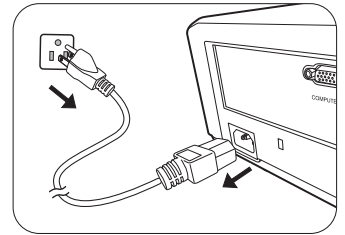

 **Avoid turning on the projector immediately after turning it off as excessive heat may shorten light source life. The actual light source life may vary due to different environmental conditions and usage.**

# Selecting an input source

The projector can be connected to multiple equipment at the same time. However, it only displays one full screen at a time. When starting up, the projector automatically searches for the available signals.

If you want the projector to always automatically search for the signals:

- Go to the **SYSTEM SETUP: Basic** menu, and then enable **Auto Input Search**. (see "[Auto Input Search](#)" on page 27)

To select the video source:

1. Press **INPUT** to display the source selection bar.



2. Press **▲/▼** until your desired signal is selected and press **OK**.

Once detected, the selected source information displays on the screen for seconds. If there are multiple pieces of equipment connected to the projector, repeat steps 1-2 to search for another signal.

 Refer to "[Projector specifications](#)" for the native display resolution of this projector. For best display picture results, you should select and use an input signal which outputs at this resolution. Any other resolutions will be scaled by the projector depending upon the Aspect Ratio setting, which may cause some image distortion or loss of picture clarity. See "[Aspect Ratio](#)" for details.

# Adjusting the projected image

## Adjusting the projection angle

The projector is equipped with 2 adjuster feet. These adjusters change the image height and projection angle. Screw the feet in or out as appropriate to aim and level the projection angle.

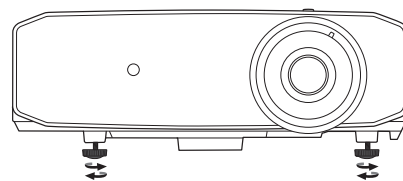

☞ If the screen and the projector are not perpendicular to each other, the projected image becomes vertical trapezoidal. To correct this, see "[Correcting keystone](#)" for details.

⚠ Do not look into the lens while the light source is on. The strong light from the light source may cause damage to your eyes.

## Fine-tuning the image size and clarity

To adjust the projected picture size, turn the zoom ring on the projector.

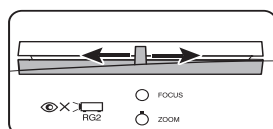
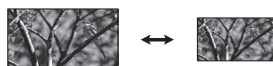

To sharpen the picture, rotate the focus ring on the projector.

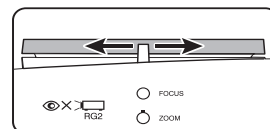
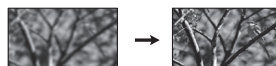

## Correcting keystone

Keystoning refers to the situation where the projected image is noticeably wider at either the top or bottom. It occurs when the projector is not perpendicular to the screen.

Besides adjusting the height of the projector, you may correct this manually by following the instructions below:

1. Do one of the following steps to display the **Keystone** window:

- Press ▲/▼ or ▼/▲ on the projector.
- Press ▲/▼ or ▼/▲ on the remote control.

2. The illustrations below show how to correct keystone distortion:



- To correct keystone at the bottom of the image, use ▼ or ▼/▲.
- To correct keystone at the top of the image, use ▲ or ▲/▼.

When done, press **BACK** to save your changes and exit.

☞ Depending on your installation conditions, keystone correction may not be possible. In such a case, if possible, reset the installation conditions and project straight to the screen.

# Menu Functions

## About the OSD Menu

To access the OSD menu, press **MENU**.

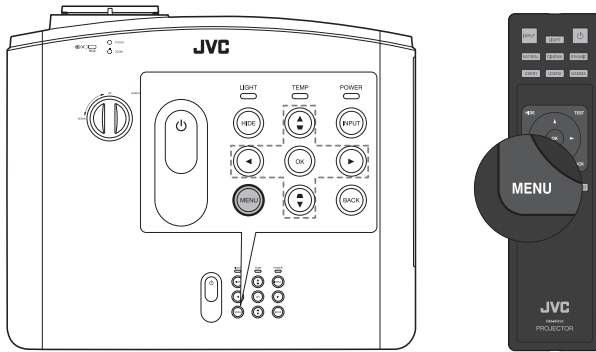

## Using the OSD menu

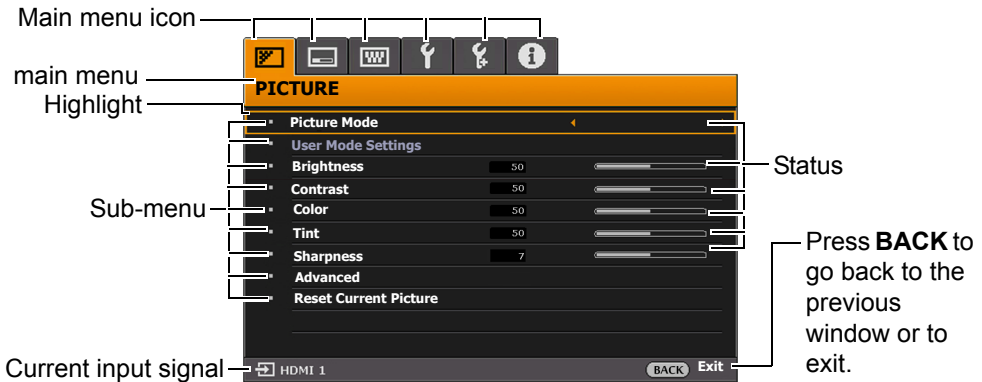



To access the OSD menu, press **MENU** on the projector or remote control. It consists of the following main menus. Check the links after the menu items below to learn more details.

1. **PICTURE** menu (see page 22)
2. **DISPLAY** menu (see page 25)
3. **INSTALLATION** menu (see page 26)
4. **SYSTEM SETUP: Basic** menu (see page 27)
5. **SYSTEM SETUP: Advanced** menu (see page 28)
6. **INFORMATION** menu (see page 28)

Available menu items may vary depending on the connected video sources or specified settings. Menu items that are not available will become grayed out.

- Use the arrow keys (◀/▶/▲/▼) on the projector or remote control to move through the menu items.
- Use **OK** to confirm the selected menu item.

# PICTURE menu

Submenu	Functions and Descriptions
<p><b>Picture Mode</b></p>	<p>Selects a preset picture mode to suit your operating environment and input signal picture type.</p> <p>The preset picture modes are described as below:</p> <ul style="list-style-type: none"> <li>• <b>Natural:</b> With well-balanced color saturation and contrast with a low brightness level, this is most suitable for video images.</li> <li>• <b>Cinema:</b> With well-balanced color saturation and contrast with a low brightness level, this is most suitable for enjoying movies in a totally dark environment (as you would find in a commercial cinema).</li> <li>• <b>Dynamic:</b> Maximizes the brightness of the projected image. This mode is suitable for environments where extra-high brightness is required, such as using the projector in well lit rooms.</li> <li>• <b>User 1/User 2:</b> Recalls the customized settings. After <b>User 1/User 2</b> is selected, some of the sub-menus under the <b>DISPLAY</b> menu can be adjusted, according to your selected input signal.</li> </ul> <p> When HDR10 or HLG (Hybrid Log-Gamma) content is inputted to the projector, it automatically switches to the appropriate picture mode.</p>
<p><b>User Mode Settings</b></p>	<p>The following functions are only available when Picture Mode is set to User 1 or User 2.</p> <ul style="list-style-type: none"> <li>• <b>Load Settings:</b> Selects a picture mode that best suits your need for the image quality and as a starting point, you can further fine-tune the image based on the selections listed below.</li> <li>• <b>Rename User Mode:</b> Select to rename the customized picture modes (<b>User 1</b> or <b>User 2</b>). The new name can be up to 9 characters including English letters (A-Z, a-z), digits (0-9), and space (_).</li> </ul>
<p><b>Brightness</b></p>	<p>Adjusts the brightness of the picture. When adjusting this control, the black areas of the picture appear just as black and details in the dark areas are visible.</p> <div style="display: flex; align-items: center;">  <div style="margin-left: 10px;"> <p>The higher the value, the brighter the picture, while the lower the value, the darker the picture.</p> </div> </div>
<p><b>Contrast</b></p>	<p>Adjusts the degree of difference between dark and light areas in the picture. After adjusting the <b>Brightness</b> value, adjust <b>Contrast</b> to set the peak white level.</p> <div style="display: flex; align-items: center;">  <div style="margin-left: 10px;"> <p>The higher the value, the greater the contrast.</p> </div> </div>
<p><b>Color</b></p>	<p>Adjusts the color saturation level - the amount of each color in a video picture. Lower settings produce less saturated colors; setting to the minimum value makes the image black and white.</p> <p>If the setting is too high, colors on the image will be overpowering, which makes the image unrealistic.</p>
<p><b>Tint</b></p>	<p>Adjusts the red and green color tones of the picture.</p> <p>The higher the value, the more reddish the picture becomes. The lower the value, the more greenish the picture becomes.</p>

Submenu	Functions and Descriptions
<b>Sharpness</b>	<p>Makes the picture look sharper or softer.</p> <div style="display: flex; align-items: center;">  <div style="margin-left: 20px;"> <p>The higher the value, the sharper the picture becomes. The lower the value, the softer the picture becomes.</p> </div> </div>
<b>Advanced</b>	<ul style="list-style-type: none"> <li>• <b>Select Gamma</b> Gamma refers to the relationship between input source and picture brightness. <ul style="list-style-type: none"> <li>• <b>2.2:</b> Normal gamma value.</li> <li>• <b>1.8/2.0/2.1/2.3/2.4/2.6:</b> The higher the value, the darker the picture.</li> <li>• <b>Contrast Priority:</b> Places more emphasis on the contrast compared to the Normal setting.</li> <li>• <b>Brightness Priority:</b> Places more emphasis on the brightness compared to the Normal setting.</li> </ul> </li> <li>• <b>Color Temperature</b> <ul style="list-style-type: none"> <li>• <b>Preset:</b> <ul style="list-style-type: none"> <li>- <b>High:</b> Makes pictures appear bluish white.</li> <li>- <b>Normal:</b> Maintains normal colorings for white.</li> <li>- <b>Low:</b> Makes pictures appear reddish white.</li> </ul> </li> </ul> <p>You can also set a preferred color temperature by adjusting the following options.</p> <ul style="list-style-type: none"> <li>• <b>Red Gain/Green Gain/Blue Gain:</b> Adjusts the contrast levels of Red, Green, and Blue.</li> <li>• <b>Red Offset/Green Offset/Blue Offset:</b> Adjusts the brightness levels of Red, Green, and Blue.</li> </ul> </li> </ul>

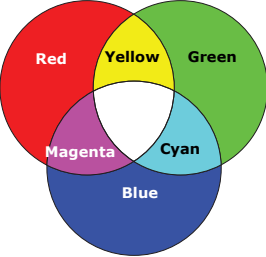

Submenu	Functions and Descriptions
<p><b>Advanced</b></p>	<ul style="list-style-type: none"> <li>• <b>3D Color Management</b>            Provides six sets (RGBCMY) of colors to be adjusted. You can select any of them to adjust its color range and saturation.           <ol style="list-style-type: none"> <li>1. Press <b>OK</b> to display the <b>3D Color Management</b> window.</li> <li>2. Select <b>Primary Color</b> and use ◀/▶ to select a color from <b>R</b> (Red), <b>G</b> (Green), <b>B</b> (Blue), <b>C</b> (Cyan), <b>M</b> (Magenta), and <b>Y</b> (Yellow).</li> <li>3. Press ▼ to select <b>Hue</b> and use ◀/▶ to set its range. Increase in the range will include colors consisted of more proportions of its two adjacent colors.</li> </ol> <div style="display: flex; align-items: center; margin: 10px 0;">  <div style="margin-left: 10px;"> <p>The illustration shows how the colors relate to each other.</p> <p>For example, if you select <b>R</b> and set its range at 0, only pure red is selected. Increasing its range will include both the red color close to yellow and red color close to magenta.</p> </div> </div> <ol style="list-style-type: none"> <li>4. Press ▼ to select <b>Gain</b> and use ◀/▶ to set its values. The contrast level of the primary color you select will be affected. Every adjustment made will reflect to the image immediately.</li> <li>5. Press ▼ to select <b>Saturation*</b> and use ◀/▶ to adjust its values. Every adjustment made reflects to the image immediately.</li> <li>6. Repeat steps 2 to 5 until you have made all of the desired adjustments.</li> <li>7. When done, press <b>BACK</b> to exit.</li> </ol> <p>*About saturation</p> <p>It is the amount of that color in a video picture. Lower settings produce less saturated colors; a setting of “0” removes that color from the image entirely. If the saturation is too high, that color will be overpowering and unrealistic.</p> </li> <li>• <b>MoviePro</b> <ul style="list-style-type: none"> <li>• <b>Color Enhancement:</b> Allows you to fine-tune the saturation of colors with larger flexibility. It modulates complex color algorithms to flawlessly render saturated colors, fine gradients, intermediate hues and subtle pigments.</li> <li>• <b>Skin Tone:</b> Provides a smart adjustment of hue only for calibrating people's skin color, not other colors in the image. It prevents discoloration of skin tones from the light of the projection beam, portraying every skin tone in its most beautiful shade.</li> <li>• <b>Super Resolution:</b> It is a super-resolution technology which radically enhances Full HD content in terms of colors, contrast, and textures. It's also a detail enhancement technology refines surface details for true-to-life images that pop off the screen. Users can adjust levels of sharpness and detail enhancement for optimal viewing.</li> </ul> </li> </ul>

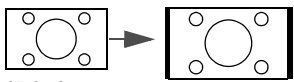
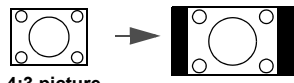
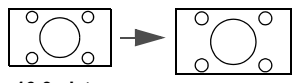
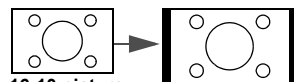

Submenu	Functions and Descriptions
<b>Advanced</b>	<ul style="list-style-type: none"> <li>• <b>HDR Settings</b> <ul style="list-style-type: none"> <li>• <b>Auto/HDR10 / HLG/SDR:</b> The projector supports HDR imaging sources. It can automatically detect the dynamic range of the source, and optimize settings to reproduce contents under wide range of light conditions. If the input source is not defined with dynamic range, you can also manually select <b>HDR10</b>, <b>HLG</b> or <b>SDR</b> for it.</li> <li>• <b>Picture Tone:</b> The projector can automatically adjust the brightness levels of your image according to the input source's meta data information. You can also manually select a brightness level to display better picture quality. When the value is higher, the image becomes brighter; when the value is lower, the image becomes darker.</li> </ul> </li> </ul>
<b>Reset Current Picture Mode</b>	Returns all of the adjustments you've made for the selected <b>Picture Mode</b> (including preset modes, <b>User 1</b> , and <b>User 2</b> ) to the factory preset values.

## DISPLAY menu

Submenu	Functions and Descriptions
<b>Aspect Ratio</b>	<p>☞ In the following illustrations, the black portions are inactive areas and the white portions are active areas.</p> <ul style="list-style-type: none"> <li>• <b>Auto</b>   <p>15:9 picture</p> <p>Scales a picture proportionally to fit the projector's native resolution in its horizontal or vertical width. This makes the most use of the screen and maintains the aspect ratio of a picture.</p> </li> <li>• <b>4:3</b>   <p>4:3 picture</p> <p>Scales the picture so that it is displayed in the center of the screen with a 4:3 aspect ratio.</p> </li> <li>• <b>16:9</b>   <p>16:9 picture</p> <p>Scales a picture so that it is displayed in the center of the screen with a 16:9 aspect ratio.</p> </li> <li>• <b>16:10</b>   <p>16:10 picture</p> <p>Scales a picture so that it is displayed in the center of the screen with a 16:10 aspect ratio.</p> </li> </ul>
<b>Image Position</b>	<p>Displays the <b>Image Position</b> window. You may use the directional arrow keys on the projector or remote control to adjust the position of the projected picture. The values shown on the lower position of the window change with every key press you made.</p> <p>☞ This function is only available when the <b>PC</b> signal is selected.</p>

Submenu	Functions and Descriptions
<b>Overscan Adjustment</b>	Conceals the poor picture quality in the four edges. The greater the value, the more portion of the picture is concealed while the screen remains filled and geometrically accurate. Setting 0 means the picture is 100% displayed.
<b>Phase</b>	Adjusts the clock phase to reduce picture distortion.  <b>This function is only available when the PC signal is selected.</b>
<b>H. Size</b>	Adjusts the horizontal width of the picture.  <b>This function is only available when the PC signal is selected.</b>
<b>Auto</b>	Automatically determines the best picture timings for the displayed image.
<b>e-shift</b>	Switches the display resolution. <ul style="list-style-type: none"> <li>• <b>Off</b>: Switches to 2K resolution.</li> </ul>  <b>Picture Mode will automatically be set to fixed mode.</b> <ul style="list-style-type: none"> <li>• <b>On</b> (recommended): Switches to 4K resolution.</li> </ul>

## INSTALLATION menu

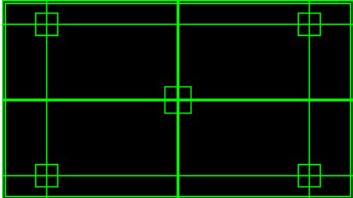





Submenu	Functions and Descriptions
<b>Projector Mode</b>	See " <a href="#">Choosing a location</a> " for details.
<b>Test Pattern</b>	Is used to adjust the image size and focus and check that the projected image is free from distortion. To close the test pattern, go back to this menu and select <b>Off</b> . 
<b>Light Source Settings</b>	<ul style="list-style-type: none"> <li>• <b>Light Source Mode</b> Select the projector light source power from the following modes. <ul style="list-style-type: none"> <li>• <b>Normal</b>: Provides full light source brightness.</li> <li>• <b>Eco</b>: Reduces system noise and light source power consumption by 30%.</li> <li>• <b>Variable LOW</b>: Adjusts the output of the light source according to the brightness of the projected image. The maximum output is same as that of the <b>Eco</b> mode.</li> <li>• <b>Variable HIGH</b>: Adjusts the output of the light source according to the brightness of the projected image. The maximum output is same as that of the <b>Normal</b> mode.</li> </ul> </li> </ul> <p>If the <b>Eco</b>, <b>Variable LOW</b> or <b>Variable HIGH</b> mode is selected, the light output will be reduced and result in darker projected pictures. See "<a href="#">Setting Light Source Mode</a>" for details.</p> <ul style="list-style-type: none"> <li>• <b>Light Source Information</b> Select to learn the duration (in hours) of light source usage which is automatically calculated by the built-in timer.</li> </ul>

Submenu	Functions and Descriptions
<b>12V Trigger</b>	<p>There is one 12V trigger that works according to your needs for installation scenarios. Two selections are available:</p> <ul style="list-style-type: none"> <li>• <b>Off:</b> If this is selected, the projector will not send electronic signal out when it is turned on.</li> <li>• <b>On:</b> The projector will send a low to high electronic signal out when it is turned on, a high to low signal out when it is turned off.</li> </ul>
<b>High Altitude Mode</b>	<p>The mode is for operation in areas like high altitude or high temperature environments. Activate the function when your environment is between 1500 m–3000 m above sea level and ambient temperature is between 0°C–30°C. Operation under <b>High Altitude Mode</b> may cause a higher decibel operating noise level because of increased fan speed necessary to improve overall system cooling and performance.</p> <p>If you use this projector under other extreme conditions excluding the above, it may display auto shut-down symptoms, which is designed to protect your projector from over-heating. In cases like this, you should switch to <b>High Altitude Mode</b> to solve these symptoms. However, this is not to state that this projector can operate under any and all harsh or extreme conditions.</p>

## SYSTEM SETUP: Basic menu

Submenu	Functions and Descriptions
<b>Language</b>	Sets the language for the On-Screen Display (OSD) menus.
<b>Background Color</b>	Sets the background color for the projector.
<b>Splash Screen</b>	Allows you to select which logo screen displays during projector start-up. You can choose <b>JVC</b> logo screen, <b>Blue</b> screen, or <b>Black</b> screen.
<b>Auto Power Off</b>	Prevents unnecessary projection when no signal is detected for a long time. See " <a href="#">Setting Auto Power Off</a> " for details.
<b>Direct Power On</b>	Allows the projector to turn on automatically once the power is fed through the power cord.
<b>Menu Settings</b>	<ul style="list-style-type: none"> <li>• <b>Menu Position</b> Sets the OSD menu position.</li> <li>• <b>Menu Display Time</b> Sets the length of time the OSD will remain active after your last key press.</li> <li>• <b>Reminder Message</b> Sets the reminder messages on or off.</li> </ul>
<b>Rename Input</b>	Renames the current input source to your desired name. use ▲/▼/◀/▶ and <b>OK</b> to set the desired characters for the connected source item.
<b>Auto Input Search</b>	Sets whether the projector searches automatically for input sources. Select <b>On</b> to enable the projector to scan for input sources until it acquires a signal. If the function is set to <b>Off</b> , the projector will select the last used input source.

## SYSTEM SETUP: Advanced menu

Submenu	Functions and Descriptions
<b>HDMI Range</b>	<ul style="list-style-type: none"> <li>• <b>Auto:</b> Sets the projector to detect the HDMI range of the input signal automatically.</li> <li>• <b>Enhance:</b> Sets the HDMI color range as 0 - 255.</li> <li>• <b>Standard:</b> Sets the HDMI color range as 16 - 235.</li> </ul>
<b>Password</b>	<p>For security purposes and to prevent unauthorized use, you may set up password security for the projector. This limits use of the projector to only those who know the correct password. If you enter an incorrect password 5 times in succession, the projector will automatically shut down in a short time.</p> <p> <b>You will be inconvenienced if you enable this function yet forget the password somehow. Do make a note of your password, and keep the note in a safe place for later recall.</b></p> <p>You will be asked to set a new password if no password has been set before. As the on-screen display indicates, the 4 arrow keys (▲/▶/▼/◀) respectively represent 4 digits (1, 2, 3, 4). Use the arrow keys to set a 6-digit password. The digits display as ***** when you enter them.</p> <ul style="list-style-type: none"> <li>• <b>Change Password</b></li> </ul> <p>You will be asked to enter the current password before changing to a new one.</p> <ul style="list-style-type: none"> <li>• <b>Power On Lock</b></li> </ul> <p>You will be asked to enter the current password before changing the setting.</p> <p> <b>Once a password has been set and the power on lock is enabled, the projector cannot be used unless the correct password is entered every time the projector is started.</b></p> <p> <b>If you forget the password, seek help from the local JVC service center. You may be required to provide proof of purchase documentation to verify that you are an authorized user of the projector.</b></p>
<b>Panel Key Lock</b>	<p>With the control keys on the projector locked, you can prevent your projector settings from being changed accidentally (by children, for example).</p> <p>When you select <b>On</b> to enable this function, no control keys on the projector will function, except  <b>POWER</b>.</p> <p>To unlock the keys, press and hold  on the projector for 3 seconds or select <b>Off</b> here using the remote control.</p> <p> <b>The function is accessible through the remote control or keypad.</b></p>
<b>Reset All Settings</b>	<p>Returns all settings to the factory preset values.</p> <p> <b>The following settings will still remain: Picture Mode, Brightness, Contrast, Color, Tint, Sharpness, Aspect Ratio, e-shift, Projector Mode, Password, Select Gamma, Color Temperature, 3D Color Management, MoviePro.</b></p>

## INFORMATION menu

Submenu	Functions and Descriptions
<b>Input</b>	Displays the current signal source.
<b>Picture Mode</b>	Displays the current picture mode under the <b>PICTURE</b> menu.

Submenu	Functions and Descriptions
<b>Resolution</b>	Displays the native resolution of the input source.
<b>Color System</b>	Displays input system format.
<b>MaxCLL</b>	Displays the Maximum Content Light Level detected.
<b>MaxFALL</b>	Displays the Maximum Frame Average Light detected.
<b>Light Source Usage Time</b>	Displays the number of hours the light source has been used.
<b>Firmware Version</b>	Shows the firmware version of your projector.

 Some information is given only when certain input sources are in use.

# OSD menu structure

The OSD menus vary according to the signal type selected.

Main menu	Submenu	Options	
<b>PICTURE</b>	Picture Mode	Natural/Cinema/Dynamic/User 1/User 2	
	User Mode Settings	Load Settings	Natural/Cinema/Dynamic/User 1/User 2
		Rename User Mode	
	Brightness		
	Contrast		
	Color		
	Tint		
	Sharpness		
	Advanced	Select Gamma	1.8/2.0/2.1/2.2/2.3/2.4/2.6/Contrast Priority/Brightness Priority
			Preset
			Red Gain
		Color Temperature	Green Gain
			Blue Gain
			Red Offset
			Green Offset
		3D Color Management	Blue Offset
			Primary Color
			Hue
		MoviePro	Gain
			Saturation
			Color Enhancement
		HDR Settings	Skin Tone
			Super Resolution
	Reset Current Picture Mode	Auto/HDR10/HLG/SDR	
	Aspect Ratio	Picture Tone	
	Image Position	Reset/Cancel	
	Overscan Adjustment	Auto/4:3/16:9/16:10	
Phase			
H. Size			
Auto			
e-shift	0-3		
<b>INSTALLATION</b>	Projector Mode	Off/On	
	Test Pattern	Front/Rear/Front Ceiling/Rear Ceiling	
	Light Source Settings	Light Source Mode	Off/On
		Light Source Information	Normal/Eco/Variable LOW/Variable HIGH
	12V Trigger	Light Source Usage Time	
	High Altitude Mode	Off/On	
	On/Off		

Main menu	Submenu	Options	
<b>SYSTEM SETUP: Basic</b>	Language	English / Français / Deutsch / Italiano / Español / Русский / 繁體中文 / 简体中文 / 日本語 / Svenska / Türkçe / Čeština / Português / Norsk / Nederlands / Polski	
	Background Color	Green/Black/Blue	
	Splash Screen	Black/Blue/JVC	
	Auto Power Off	Disable/5 min/10 min/15 min/20 min/25 min/30 min	
	Direct Power On	Off/On	
	Menu Settings	Menu Position	Center/Top-Left/Top-Right/Bottom-Right/Bottom-Left
		Menu Display Time	Always On/5 sec/10 sec/15 sec/20 sec/25 sec/30 sec
		Reminder Message	Off/On
	Rename Input		
	Auto Input Search	Off/On	
	<b>SYSTEM SETUP: Advanced</b>	HDMI Range	Auto/Standard/Enhance
Password		Change Password	
		Power On Lock	On/Off
Panel Key Lock		Off/On	
Reset All Settings		Reset/Cancel	
<b>INFORMATION</b>	Input		
	Picture Mode		
	Resolution		
	Color System		
	MaxCLL		
	MaxFALL		
	Light Source Usage Time		
Firmware Version			

# Maintenance

## Care of the projector

### Cleaning the lens

Clean the lens whenever you notice dirt or dust on the surface.

Before cleaning any part of the projector, turn it off using the proper shutdown procedure (see "[Shutting down the projector](#)"), unplug the power cable, and let it cool down completely.

- Use a canister of compressed air to remove dust.
- If there is dirt or smears, use lens-cleaning paper or moisten a soft cloth with lens cleaner and gently wipe the lens surface.
- Never use any type of abrasive pad, alkaline/acid cleaner, scouring powder, or volatile solvent, such as alcohol, benzene, thinner or insecticide. Using such materials or maintaining prolonged contact with rubber or vinyl materials may result in damage to the projector surface and cabinet material.

 **Never touch the lens with your finger or rub the lens with abrasive materials. Even paper towels can damage the lens coating. Only ever use a proper photographic lens brush, cloth, and cleaning solution. Do not attempt to clean the lens while the projector is switched on or is still hot from previous use.**

### Cleaning the projector case

Before cleaning any part of the projector, turn it off using the proper shutdown procedure (see "[Shutting down the projector](#)"), unplug the power cable, and let it cool down completely.

- To remove dirt or dust, wipe the case with a soft, dry, lint-free cloth.
- To remove stubborn dirt or stains, moisten a soft cloth with water and a neutral detergent. Then wipe the case.

 **Never use wax, alcohol, benzene, thinner or other chemical detergents. These can damage the case.**

### Storing the projector

To store the projector for an extended time:

- Make sure the temperature and humidity of the storage area are within the recommended range for the projector. Refer to "[Specifications](#)" or consult your dealer about the range.
- Retract the adjuster feet.
- Remove the batteries from the remote control.
- Pack the projector in its original packing or equivalent.

### Transporting the projector

It is recommended that you ship the projector with its original packing or equivalent.



# Light source information

## Getting to know the light source hour

When the projector is in operation, the duration (in hours) of light source usage is automatically calculated by the built-in timer.

To obtain the light source hour information:

1. Press **MENU**.
2. Use the arrow keys (◀/▶/▲/▼) to go to **INFORMATION** or enter the **INSTALLATION > Light Source Settings > Light Source Information** menu.
3. The **Light Source Usage Time** information displays.
4. Press **MENU** to exit.

## Extending light source life

To keep the light source life as long as possible, you can do the following settings via the OSD menu.

To access the OSD menu, see ["Using the OSD menu"](#) for details.

## Setting Light Source Mode

Light source life can be extended by changing the light source mode.

1. Go to **INSTALLATION > Light Source Settings > Light Source Mode**.
2. Press ◀/▶ to move to your desired mode, and press **OK**.
3. When done, press **MENU** to save your changes and exit.



## Setting Auto Power Off

This function allows the projector to turn off automatically if no input source is detected after a set period of time.

1. Go to **SYSTEM SETUP: Basic > Auto Power Off**.
2. Press ◀/▶ to select a time period. If the preset time lengths are not suitable for your presentation, select **Disable**, and the projector will not automatically shut down in a certain time period.
3. When done, press **MENU** to save your changes and exit.

# Indicators

There are 3 indicators which show the status of the projector. Check the following information about the indicator lights. If there is anything wrong, turn the projector off and contact your dealer.

Light			Status & Description
LIGHT 	TEMP 	POWER 	
<b>Power events</b>			
Off	Off	Orange	Stand-by mode
Off	Off	Green Flashing	Powering up
Off	Off	Green	Normal operation
Off	Off	Orange Flashing	Normal power-down cooling
Red Flashing	Red Flashing	Red Flashing	Downloading
Red	Off	Green	CW start fail
Red Flashing	Off	Green	CW spin fail
Red	Off	Red	Scaler shutdown fail (data abort)
<b>Light source events</b>			
Red	Off	Off	Light source error in normal operation
Orange Flashing	Off	Off	Light source is not lit up
Orange	Off	Green	Light source life exhausted
<b>Thermal events</b>			
Off	Red	Red	Fan 1 error (the actual fan speed is outside the desired speed)
Off	Red Flashing	Red	Fan 2 error (the actual fan speed is outside the desired speed)
Off	Green	Red	Fan 3 error (the actual fan speed is outside the desired speed)
Off	Green	Red	Fan 4 error (the actual fan speed is outside the desired speed)
Off	Red	Red Flashing	Fan 5 error (the actual fan speed is outside the desired speed)
Off	Red Flashing	Red Flashing	Fan 6 error (the actual fan speed is outside the desired speed)
Off	Red	Green	Temperature 1 error (over limited temperature)

# Troubleshooting

Problem	Cause	Remedy
The projector does not turn on.	There is no power from the power cable.	Plug the power cable into the AC inlet on the rear of the projector, and plug the power cable into to the power outlet. If the power outlet has a switch, make sure that it is switched on.
	Attempting to turn the projector on again during the cooling process.	Wait until the cooling down process has completed.
No picture.	The video source is not turned on or connected correctly.	Turn the video source on and check that the signal cable is connected correctly.
	The projector is not correctly connected to the input source device.	Check the connection.
	The input source has not been correctly selected.	Select the correct source with the <b>INPUT</b> key on the projector or remote control.
	The HDMI cable does not support 4K signal.	Use a certified Premium High Speed HDMI Cable (18 Gbps compatible).
Image is unstable.	The connection cables are not securely connected to the projector or the signal source.	Correctly connect the cables to the appropriate terminals.
Picture is blurred.	The projection lens is not correctly focused.	Adjust the focus of the lens using the focus ring.
	The projector and the screen are not aligned properly.	Adjust the projection angle and direction as well as the height of this projector if necessary.
	The lens cover is still closed. (If available)	Remove the lens cover. (If available)
Remote control does not work correctly.	The battery is out of power.	Replace both of the battery with new one.
	There is an obstacle between the remote control and the projector.	Remove the obstacle.
	You are too far away from the projector.	Stand within 8 meters (26.2 feet) of the projector.

# Specifications

## Projector specifications

 All specifications are subject to change without notice.

### Optical

#### Resolution

1920 x 1080

3840 x 2160 with e-shift

#### Display system

Single-chip DLP™ system

#### Lens

F = 1.809, f = 14.3~22.9 mm

#### Light source

Laser

### Electrical

#### Power supply

AC100–240V, 3.7 A, 50-60 Hz (Automatic)

#### Power consumption

360 W (Max); < 0.5 W (Standby);

### Output terminals

12VDC (Max. 0.1 A) x 1

DC 5V output (Max. 1.5 A) x 1

### Control

RS-232 serial control

9 pin x 1

IR receiver x 2

USB Mini-B x 1

### Input terminals

#### Computer input

RGB input

D-Sub 15-pin (female) x 1

#### Video signal input

SD/HDTV signal input

Digital - HDMI x 2

### Environmental Requirements

#### Operating temperature

0°C–40°C at sea level

#### Operating relative humidity

10%–90% (without condensation)

#### Operating altitude

0–1499 m at 0°C–35°C

1500–3000 m at 0°C–30°C (with

High Altitude Mode on)

### Mechanical

#### Weight

6.3 Kg (13.89 lbs)

# Dimensions

405 mm x 341 mm x 145.8 mm (15 • 7/8" x 13 • 1/2" x 5 • 3/4") (W x D x H)

Unit: mm (inches)

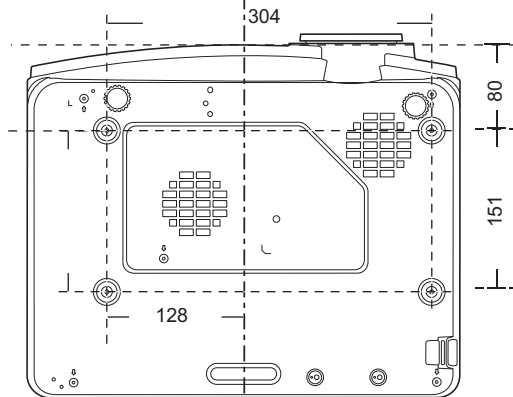
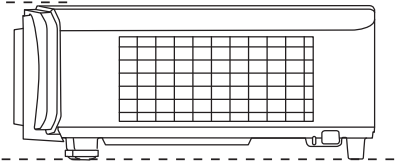
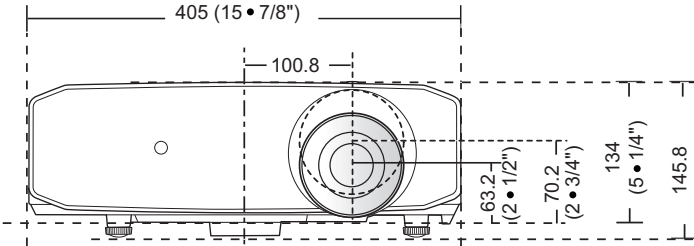
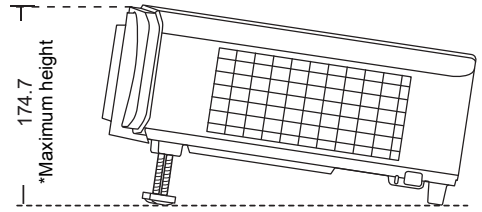
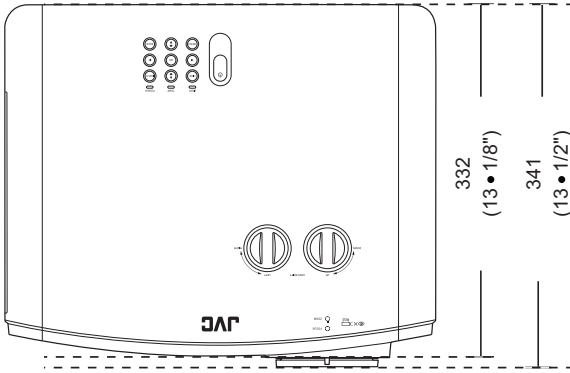

Ceiling mount screws: M4  
Length = 8 mm

# Timing chart

## Supported timing for PC input

Format	Resolution	Refresh rate (Hz)	Horizontal Frequency (KHz)	Pixel Frequency (MHz)
720 x 400	720 x 400_70	70.087	31.469	28.3221
640 x 480	VGA_60	59.940	31.469	25.175
	VGA_72	72.809	37.861	31.500
	VGA_75	75.000	37.500	31.500
	VGA_85	85.008	43.269	36.000
800 x 600	SVGA_60	60.317	37.879	40.000
	SVGA_72	72.188	48.077	50.000
	SVGA_75	75.000	46.875	49.500
	SVGA_85	85.061	53.674	56.250
	SVGA_120 (Reduce Blanking)	119.854	77.425	83.000
1024 x 768	XGA_60	60.004	48.363	65.000
	XGA_70	70.069	56.476	75.000
	XGA_75	75.029	60.023	78.750
	XGA_85	84.997	68.667	94.500
	XGA_120 (Reduce Blanking)	119.989	97.551	115.500
1152 x 864	1152 x 864_75	75.00	67.500	108.000
1280 x 720	1280 x 720_60	60	45.000	74.250
	1280 x 720_120	120	90.000	148.500
1280 x 768	1280 x 768_60 (Reduce Blanking)	60	47.396	68.25
	1280 x 768_60	59.870	47.776	79.5
1280 x 800	WXGA_60	59.810	49.702	83.500
	WXGA_75	74.934	62.795	106.500
	WXGA_85	84.880	71.554	122.500
	WXGA_120 (Reduce Blanking)	119.909	101.563	146.25

1280 x 1024	SXGA_60	60.020	63.981	108.000
	SXGA_75	75.025	79.976	135.000
	SXGA_85	85.024	91.146	157.500
1280 x 960	1280 x 960_60	60.000	60.000	108
	1280 x 960_85	85.002	85.938	148.500
1360 x 768	1360 x 768_60	60.015	47.712	85.500
1440 x 900	WXGA+_60 (Reduce Blanking)	60	55.469	88.75
	WXGA+_60	59.887	55.935	106.500
1400 x 1050	SXGA+_60	59.978	65.317	121.750
1600 x 1200	UXGA	60.000	75.000	162.000
1680 x 1050	1680 x 1050_60 (Reduce Blanking)	59.883	64.674	119.000
	1680 x 1050_60	59.954	65.290	146.250
640 x 480@67Hz	MAC13	66.667	35.000	30.240
832 x 624@75Hz	MAC16	74.546	49.722	57.280
1024 x 768@75Hz	MAC19	74.93	60.241	80.000
1152 x 870@75Hz	MAC21	75.06	68.68	100.00
1920 x 1080@60Hz	1920 x 1080_60 (Reduce Blanking)	60	67.5	148.5
1920 x 1200@60Hz	1920 x 1200_60 (Reduce Blanking)	59.95	74.038	154

 The timings showing above may not be supported due to EDID file and VGA graphic card limitations. It is possible that some timings cannot be chosen.

## Supported timing for HDMI (HDCP) input

Format	Resolution	Vertical Frequency (Hz)	Horizontal Frequency (KHz)	Pixel Frequency (MHz)
640 x 480	VGA_60	59.940	31.469	25.175
	VGA_72	72.809	37.861	31.500
	VGA_75	75.000	37.500	31.500
	VGA_85	85.008	43.269	36.000
720 x 400	720 x 400_70	70.087	31.469	28.3221
800 x 600	SVGA_60	60.317	37.879	40.000
	SVGA_72	72.188	48.077	50.000
	SVGA_75	75.000	46.875	49.500
	SVGA_85	85.061	53.674	56.250
	SVGA_120 (Reduce Blanking)	119.854	77.425	83.000
1024 x 768	XGA_60	60.004	48.363	65.000
	XGA_70	70.069	56.476	75.000
	XGA_75	75.029	60.023	78.750
	XGA_85	84.997	68.667	94.500
	XGA_120 (Reduce Blanking)	119.989	97.551	115.500
1152 x 864	1152 x 864_75	75.00	67.500	108.000
1280 x 720	1280 x 720_60	60	45.000	74.250
	1280 x 720_120	120	90.000	148.500
1280 x 768	1280 x 768_60 (Reduce Blanking)	60	47.396	68.25
	1280 x 768_60	59.870	47.776	79.5
1280 x 800	WXGA_60	59.810	49.702	83.500
	WXGA_75	74.934	62.795	106.500
	WXGA_85	84.880	71.554	122.500
	WXGA_120 (Reduce Blanking)	119.909	101.563	146.25
1280 x 1024	SXGA_60	60.020	63.981	108.000
	SXGA_75	75.025	79.976	135.000
	SXGA_85	85.024	91.146	157.500



1280 x 960	1280 x 960_60	60.000	60.000	108
	1280 x 960_85	85.002	85.938	148.500
1360 x 768	1360 x 768_60	60.015	47.712	85.500
1440 x 900	WXGA+_60 (Reduce Blanking)	60	55.469	88.75
	WXGA+_60	59.887	55.935	106.500
1400 x 1050	SXGA+_60	59.978	65.317	121.750
1600 x 1200	UXGA	60.000	75.000	162.000
1680 x 1050	1680 x 1050_60 (Reduce Blanking)	59.883	64.674	119.000
	1680 x 1050_60	59.954	65.290	146.250
640 x 480@67Hz	MAC13	66.667	35.000	30.240
832 x 624@75Hz	MAC16	74.546	49.722	57.280
1024 x 768@75Hz	MAC19	75.020	60.241	80.000
1152 x 870@75Hz	MAC21	75.06	68.68	100.00
1920 x 1080@60Hz	1920 x 1080_60 (Reduce Blanking)	60	67.5	148.5
1920 x 1200@60Hz	1920 x 1200_60 (Reduce Blanking)	59.95	74.038	154
3840 x 2160	3840 x 2160_30	30	67.5	297
3840 x 2160	3840 x 2160_60 Only via HDMI 1 port)	60	135	594

 The timings showing above may not be supported due to EDID file and VGA graphic card limitations. It is possible that some timings cannot be chosen.

Timing	Resolution	Vertical Frequency (Hz)	Horizontal Frequency (KHz)	Pixel Frequency (MHz)
480i	720 (1440) x 480	59.94	15.73	27
480p	720 x 480	59.94	31.47	27
576i	720 (1440) x 576	50	15.63	27
576p	720 x 576	50	31.25	27
720/50p	1280 x 720	50	37.5	74.25
720/60p	1280 x 720	60	45.00	74.25
1080/24P	1920 x 1080	24	27	74.25
1080/25P	1920 x 1080	25	28.13	74.25
1080/30P	1920 x 1080	30	33.75	74.25
1080/50i	1920 x 1080	50	28.13	74.25
1080/60i	1920 x 1080	60	33.75	74.25
1080/50P	1920 x 1080	50	56.25	148.5
1080/60P	1920 x 1080	60	67.5	148.5
2160/24P	3840 x 2160	24	54	297
2160/25P	3840 x 2160	25	56.25	297
2160/30P	3840 x 2160	30	67.5	297
2160/50P	3840 x 2160 (Only via HDMI 1 port)	50	112.5	594
2160/60P	3840 x 2160 (Only via HDMI 1 port)	60	135	594

# Warranty and Copyright information

## Warranty

JVCKENWOOD Corporation warrants this product against any defects in material and workmanship, under normal usage and storage.

Proof of purchase date will be required with any warranty claim. In the event this product is found to be defective within the warranty period, JVCKENWOOD Corporation's only obligation and your exclusive remedy shall be replacement of any defective parts (labor included). To obtain warranty service, immediately notify the dealer from which you purchased the product of any defects.

Important: The above warranty shall be void if the customer fails to operate the product in accordance with JVCKENWOOD Corporation's written instructions, especially the ambient humidity and altitude must meet the environmental requirements listed in the user manual, and avoiding to operate the projector in a dusty environment. This warranty gives you specific legal rights, and you may have other rights which vary from country to country.

## Copyright

Copyright © 2019. All rights reserved. No part of this publication may be reproduced, transmitted, transcribed, stored in a retrieval system or translated into any language or computer language, in any form or by any means, electronic, mechanical, magnetic, optical, chemical, manual or otherwise, without the prior written permission of JVCKENWOOD Corporation .

All trademarks and registered trademarks are the property of their respective owners.

## Disclaimer

JVCKENWOOD Corporation makes no representations or warranties, either expressed or implied, with respect to the contents hereof and specifically disclaims any warranties, merchantability or fitness for any particular purpose. Further, JVCKENWOOD Corporation reserves the right to revise this publication and to make changes from time to time in the contents hereof without obligation of JVCKENWOOD Corporation to notify any person of such revision or changes.