

D-ILA PROJECTOR

DLA-NZ900
DLA-NZ800
DLA-RS4200
DLA-RS3200

D-ILA[®]
HDMI[™]
HIGH-DEFINITION MULTIMEDIA INTERFACE

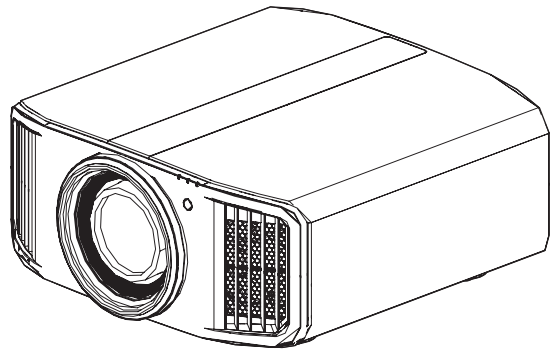

Mobile User Guide

● <https://manual3.jvckenwood.com/projector/mobile/global/>

The Mobile User Guide can be viewed on mobile internet devices including smartphones and tablets.



For Customer use :

Enter below the serial No. which is located on the side of the cabinet. Retain this information for future reference.

Model No. DLA-NZ900K, DLA-NZ800K, DLA-NZ900E, DLA-NZ800E,
DLA-RS4200K, DLA-RS3200K, DLA-RS4200E, DLA-RS3200E

Serial No. _____

Not suitable for household room illumination.

Safety Precautions

IMPORTANT INFORMATION

WARNING:

TO PREVENT FIRE OR SHOCK HAZARDS, DO NOT EXPOSE THIS APPLIANCE TO RAIN OR MOISTURE.

WARNING:

THIS APPARATUS MUST BE EARTHED.

CAUTION:

To reduce the risk of electric shock, do not remove cover. Refer servicing to qualified service personnel.

This projector is equipped with a 3-blade grounding type plug to satisfy FCC rule. If you are unable to insert the plug into the outlet, contact your electrician.

NOISE EMISSION DECLARATION

The sound pressure level at the operator position is equal or less than 60dB(A) according to ISO7779.

WARNING

REMOVE THE LENS COVER BEFORE TURNING ON THE PROJECTOR

FCC INFORMATION (U.S.A. only)

CAUTION:

Changes or modification not approved by JVC could void the user's authority to operate the equipment.

NOTE:

This equipment has been tested and found to comply with the limits for Class B digital devices, pursuant to Part 15 of the FCC Rules. These limits are designed to provide reasonable protection against harmful interference in a residential installation. This equipment generates, uses, and can radiate radio frequency energy and, if not installed and used in accordance with the instructions, may cause harmful interference to radio communications. However, there is no guarantee that interference will not occur in a particular installation. If this equipment does cause harmful interference to radio or television reception, which can be determined by turning the equipment off and on, the user is encourage to try to correct the interference by one or more of the following measures:

- Reorient or relocate the receiving antenna.
- Increase the separation between the equipment and receiver.
- Connect the equipment into an outlet on a circuit different from that to which the receiver is connected.
- Consult the dealer or an experienced radio/TV technician for help.

Supplier's Declaration of Conformity

Trade Name: **JVC**
Products: **D-ILA Projector**
Model Name: **DLA-NZ900BK, DLA-NZ800BK, DLA-NZ900WK, DLA-NZ800WK, DLA-RS4200K, DLA-RS3200K**
Responsible Party: **JVCKENWOOD USA Corporation**
1440 Corporate Drive, Irving, TX 75038
Telephone number: 678-449-8879

This device complies with Part 15 of the FCC Rules. Operation is subject to the following two conditions;

- (1) This device may not cause harmful interference, and
- (2) This device must accept any interference received, including interference that may cause undesired operation.

IMPORTANT SAFEGUARDS

Electrical energy can perform many useful functions. This unit has been engineered and manufactured to assure your personal safety. But **IMPROPER USE CAN RESULT IN POTENTIAL ELECTRICAL SHOCK OR FIRE HAZARD.** In order not to defeat the safeguards incorporated into this product, observe the following basic rules for its installation, use and service. Please read these Important Safeguards carefully before use.

- All the safety and operating instructions should be read before the product is operated.
 - The safety and operating instructions should be retained for future reference.
 - All warnings on the product and in the operating instructions should be adhered to.
 - All operating instructions should be followed.
 - Place the projector near a wall outlet where the plug can be easily unplugged.
 - Unplug this product from the wall outlet before cleaning.
 - Do not use liquid cleaners or aerosol cleaners. Use a damp cloth for cleaning.
 - Do not use attachments not recommended by the product manufacturer as they may be hazardous.
 - Do not use this product near water. Do not use immediately after moving from a low temperature to high temperature, as this causes condensation, which may result in fire, electric shock, or other hazards.
 - Do not place this product on an unstable cart, stand, or table. The product may fall, causing serious injury to a child or adult, and serious damage to the product. The product should be mounted according to the manufacturer's instructions, and should use a mount recommended by the manufacturer.
 - When the product is used on a cart, care should be taken to avoid quick stops, excessive force, and uneven surfaces which may cause the product and cart to overturn, damaging equipment or causing possible injury to the operator.
- PORTABLE CART WARNING
(symbol provided by RETAC)



S3126A

When the product is used on a cart, care should be taken to avoid quick stops, excessive force, and uneven surfaces which may cause the product and cart to overturn, damaging equipment or causing possible injury to the operator.
- Slots and openings in the cabinet are provided for ventilation. These ensure reliable operation of the product and protect it from overheating. These openings must not be blocked or covered. (The openings should never be blocked by placing the product on bed, sofa, rug, or similar surface. It should not be placed in a built-in installation such as a bookcase or rack unless proper ventilation is provided and the manufacturer's instructions have been adhered to.)
 - To allow better heat dissipation, keep a clearance between this unit and its surrounding as shown below. When this unit is enclosed in a space of dimensions as shown below, use an air-conditioner so that the internal and external temperatures are the same. Overheating can cause damage.

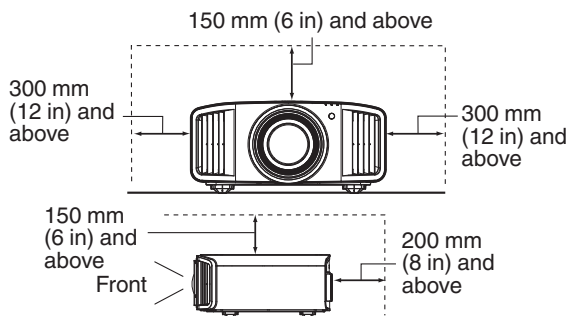

- Power source indicated on the label. If you are not sure of the type of power supply to your home, consult your product dealer or local power company.
- This product is equipped with a three-wire plug. This plug will fit only into a grounded power outlet. If you are unable to insert the plug into the outlet, contact your electrician to install the proper outlet. Do not defeat the safety purpose of the grounded plug.
- Power-supply cords should be routed so that they are not likely to be walked on or pinched by items placed upon or against them. Pay particular attention to cords at doors, plugs, receptacles, and the point where they exit from the product.
- For added protection of this product during a lightning storm, or when it is left unattended and unused for long periods of time, unplug it from the wall outlet and disconnect the cable system. This will prevent damage to the product due to lightning and power line surges.
- Do not overload wall outlets, extension cords, or convenience receptacles on other equipment as this can result in a risk of fire or electric shock.
- Never push objects of any kind into this product through openings as they may touch dangerous voltage points or short out parts that could result in a fire or electric shock. Never spill liquid of any kind on the product.
- Do not attempt to service this product yourself as opening or removing covers may expose you to dangerous voltages and other hazards. Refer all service to qualified service personnel.
- Unplug this product from the wall outlet and refer service to qualified service personnel under the following conditions:
 - a) When the power supply cord or plug is damaged.
 - b) If liquid has been spilled, or objects have fallen on the product.
 - c) If the product has been exposed to rain or water.
 - d) If the product does not operate normally by following the operating instructions. Adjust only those controls that are covered by the Operation Manual, as an improper adjustment of controls may result in damage and will often require extensive work by a qualified technician to restore the product to normal operation.
 - e) If the product has been dropped or damaged in any way.
 - f) When the product exhibits a distinct change in performance, this indicates a need for service.

- When replacement parts are required, be sure the service technician has used replacement parts specified by the manufacturer or with same characteristics as the original part. Unauthorized substitutions may result in fire, electric shock, or other hazards.
 - Upon completion of any service or repairs to this product, ask the service technician to perform safety checks to determine that the product is in proper operating condition.
 - The product should be placed more than one foot away from heat sources such as radiators, heat registers, stoves, and other products (including amplifiers) that produce heat.
 - When connecting other products such as VCR's, and DVD players, you should turn off the power of this product for protection against electric shock.
 - Do not place combustibles behind the cooling fan. For example, cloth, paper, matches, aerosol cans or gas lighters that present special hazards when over heated.
 - Do not ceiling-mount the projector to a place which tends to vibrate; otherwise, the attaching fixture of the projector could be broken by the vibration, possibly causing it to fall or overturn, which could lead to personal injury.
 - Use only the accessory cord designed for this product to prevent shock.
 - For health reasons, please take a break of about 5-15 minutes every 30-60 minutes and let your eyes rest. When using the devices with 3D function, please refrain from watching any 3D-images when you feel tired, unwell or if you feel any other discomfort. Moreover, in case you see a double image, please adjust the equipment and software for proper display. Please stop using the unit if the double image is still visible after adjustment.
 - Once every three years, please perform an internal test. This unit is provided with replacement parts needed to maintain its function (such as cooling fans). Estimated replacement time of parts can vary greatly depending on frequency of use and the respective environment. For replacement, please consult your dealer, or the nearest authorized JVC service center.
 - When fixing the unit to the ceiling, Please note that we do not take any responsibility, even during the warranty period, if the product is damaged due to use of metal fixtures used for fixation to the ceiling other than our own or if the installation environment of said metal fixtures is not appropriate. If the unit is suspended from the ceiling during use, please be careful in regard to the ambient temperature of the unit. If you use a central heating, the temperature close to the ceiling will be higher than normally expected.
 - Video images can burn into the electronic component parts. Please do not display screens with still images of high brightness or high contrast, such as found in video games and computer programs. Over a long period of time it might stick to the picture element. There is no problem with the playback of moving images, e.g. normal video footage.
 - Install the outlet at an accessible height to unplug from the wall. Or install the circuit breaker at an accessible height to shut down the projector. If you need information, please consult your authorized dealer or specialist.
 - This unit is heavy in weight. Please ensure that there are at least two persons carrying it.
 - Do not project images with the lens cover attached. Otherwise, the lens cover may be deformed due to the heat, or the projector may malfunction.
 - Do not place your hand into the opening near the lens while lens shift is in progress. Otherwise, your hand may get caught, resulting in an injury.
 - Not using the unit for a long time can lead to malfunction. Please power it on and let it run occasionally. Please avoid using the unit in a room where cigarettes are smoked. It is impossible to clean optical component parts if they are contaminated by nicotine or tar. This might lead to performance degradation.
- Pay attention to the following when using the devices with 3D function.
- Please watch from a distance three times the height of the projected image size. Persons with photosensitivity, any kind of heart disease, or weak health should not use 3D glasses.
 - Watching 3D-images might be cause of illness. If you feel any change in your physical condition, please stop watching immediately and consult a physician if necessary.
 - When watching 3D images, it is recommended to take regular breaks. As the length and frequency of the required breaks differ for every person, please judge according to your own condition.
 - If your child watches while wearing 3D glasses, it should be accompanied by its parents or an adult guardian. The adult guardian should be careful to avoid situations where the child's eyes might become tired, as responses to tiredness and discomfort, etc., are hard to detect, and it is possible for the physical condition to deteriorate very quickly. As the visual sense is not yet fully developed in children under the age of 6, please consult a physician in regard to any problem concerning 3D-images if necessary.
 - Note that when using the 3D feature, the video output may appear different from the original video image due to image conversion on the device.
- * DO NOT allow any unqualified person to install the unit.**

Be sure to ask your dealer to install the unit (e.g. attaching it to the ceiling) since special technical knowledge and skills are required for installation. If installation is performed by an unqualified person, it may cause personal injury or electrical shock.
- Do not use optical instruments (such as magnifying glass or reflector) viewing the laser output. It may pose an eye hazard.
 - When turning on the projector, ensure that no one is looking into the projection lens.
 - Do not look into the lens and openings when the light is on. Doing so would have serious effects on the human body.
 - Do not detach or attach the projection lens with the power connected.
 - Attempting to disassemble, repair or modify the projector yourself may lead to serious safety issues.
 - Using a faulty product not only results in electrical shock or fire hazard, it can cause visual impairment.
 - When abnormality occur, stop using the projector immediately and send it to your authorized dealer for repair.
- About the installation place**
- Do not install the projector in a place that cannot support its weight securely. If the installation place is not sturdy enough, the projector could fall or overturn, possibly causing personal injury.

POWER CONNECTION

For USA and Canada only
Use only the following power cord.

Power cord



The power supply voltage rating of this product is AC100V – AC240V. Use only the power cord designated by our dealer to ensure Safety and EMC. Ensure that the power cable used for the projector is the correct type for the AC outlet in your country. Consult your product dealer.

Power cord

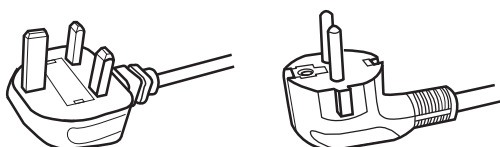

For United Kingdom

For European continent
countries

WARNING:

Do not cut off the main plug from this equipment.

If the plug fitted is not suitable for the power points in your home or the cable is too short to reach a power point, then obtain an appropriate safety approved extension lead or adapter or consult your dealer. If nonetheless the mains plug is cut off, dispose of the plug immediately, to avoid a possible shock hazard by inadvertent connection to the main supply.

WARNING:

THIS APPARATUS MUST BE EARTHED.

Dear Customer,

This apparatus is in conformance with the valid European directives and standards regarding electromagnetic compatibility and electrical safety. European representative of JVC KENWOOD Corporation is: JVC KENWOOD Deutschland GmbH Konrad-Adenauer-Allee 1-11, 61118 Bad Vilbel, GERMANY

IMPORTANT (Europe only):

The wires in the mains lead on this product are colored in accordance with the following code:

Green-and-yellow : Earth
Blue : Neutral
Brown : Live

As these colors may not correspond with the colored making identifying the terminals in your plug, proceed as follows:

The wire which is colored green-and-yellow must be connected to the terminal which is marked M with the letter E or the safety earth or colored green or green-and-yellow. The wire which is colored blue must be connected to the terminal which is marked with the letter N or colored black.

The wire which is colored brown must be connected to the terminal which is marked with the letter L or colored red.

POWER CONNECTION (United Kingdom only)

HOW TO REPLACE THE FUSE:

When replacing the fuse, be sure to use only a correctly rated approved type, re-fit the fuse cover.

IF IN DOUBT — CONSULT A COMPETENT ELECTRICIAN.

Open the fuse compartment with the blade screwdriver, and replace the fuse.

(* An example is shown in the illustration below.)

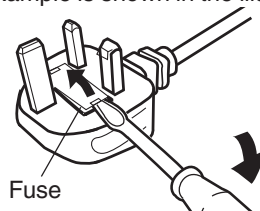

Battery

Information on Battery into the Remote Controller

The batteries included with this product comply with EU battery regulations.

Type : R03(NWC)

Manufacturer : Panasonic Energy Co., Ltd.

Address : 1-1, matsushita-cho, moriguchi-shi,
osaka 570-8511, JAPAN

URL : <https://www.panasonic.com/global/energy/>

Information for Users on Disposal of Old Equipment and Batteries



Products



Battery

[European Union only]

These symbols indicate that equipment with these symbols should not be disposed of as general household waste. If you want to dispose of the product or battery, please consider the collection systems or facilities for appropriate recycling.

Notice: The sign Pb below the symbol for batteries indicates that this battery contains lead.

Informations relatives à l'élimination des appareils et des piles usagés, à l'intention des utilisateurs



Produits



Pile

[Union européenne seulement]

Si ces symboles figurent sur les produits, cela signifie qu'ils ne doivent pas être jetés comme déchets ménagers. Si vous voulez jeter ce produit ou cette pile, veuillez considérer le système de collecte des déchets ou les centres de recyclage appropriés.

Notification: La symbole Pb en dessous du symbole des piles indique que cette pile contient du plomb.

Información para los usuarios sobre la eliminación de baterías/pilas usadas



Productos



Baterías/pilas

[Sólo Unión Europea]

Estos símbolos indican que el equipo con estos símbolos no debe desecharse con la basura doméstica. Si desea desechar el producto o batería/pila, acuda a los sistemas o centros de recogida para que los reciclen debidamente.

Atención: La indicación Pb debajo del símbolo de batería/pila indica que ésta contiene plomo.

Benutzerinformationen zur Entsorgung alter Geräte und Batterien



Produkte



Batterie

[Nur Europäische Union]

Diese Symbole zeigen an, dass derartig gekennzeichnete Geräte nicht als normaler Haushaltsabfall entsorgt werden dürfen. Wenden Sie sich zur Entsorgung des Produkts oder der Batterie an die hierfür vorgesehenen Sammelstellen oder Einrichtungen, damit eine fachgerechte Wiederverwertung möglich ist.

Hinweis: Das Zeichen Pb unterhalb des Batteriesymbols gibt an, dass diese Batterie Blei enthält.

Informazioni per gli utenti sullo smaltimento delle apparecchiature e batterie obsolete



Prodotti



Batteria

[Solo per l'Unione Europea]

Questi simboli indicano che le apparecchiature a cui sono relativi non devono essere smaltite tra i rifiuti domestici generici. Se si desidera smaltire questo prodotto o questa batteria, prendere in considerazione i sistemi o le strutture di raccolta appropriati per il riciclaggio corretto.

Nota: Il simbolo Pb sotto il simbolo delle batterie indica che questa batteria contiene piombo.

Informatie voor gebruikers over het verwijderen van oude apparatuur en batterijen



Producten



Batterij

[Alleen Europese Unie]

Deze symbolen geven aan dat apparatuur met dit symbool niet mag worden weggegooid als algemeen huishoudelijk afval. Als u het product of de batterij wilt weggooien, kunt u inzamelsystemen of faciliteiten voor een geschikte recycling gebruiken.

Opmerking: Het teken Pb onder het batterijsymbool geeft aan dat deze batterij lood bevat.

Informacje dla użytkowników dotyczące utylizacji starego sprzętu i baterii



Produkty



Baterie

[Tylko dla Unii Europejskiej]

Symbol te wskazują, że sprzętu oznaczonego tymi symbolami nie należy wyrzucać wraz z odpadami domowymi. Jeśli chcesz zutylizować produkt lub baterię, rozważ systemy zbiórki lub urządzenia do odpowiedniego recyklingu.

UWAGA: Znak Pb pod symbolem baterii wskazuje, że ta bateria zawiera ołów.

**CLASS 1 LASER PRODUCT
PRODUIT LASER DE CLASSE 1
PRODUCTO LÁSER DE CLASE 1
LASERPRODUKT DER KLASSE 1
PRODOTTO LASER DI CLASSE 1
KLASSE 1 LASERPRODUCT
PRODUKT LASEROWY KLASY 1**

**LASER CAUTION LABEL
ÉTIQUETTE DE MISE EN GARDE POUR LE LASER
ETIQUETA DE PRECAUCIÓN DEL LÁSER
LASERWARNSCHILD
ETICHETTA DI ATTENZIONE LASER
LASER WAARSCHUWINGSETIKET
ETYKIETA OSTRZEGAWCZA DOTYCZĄCA LASERA**

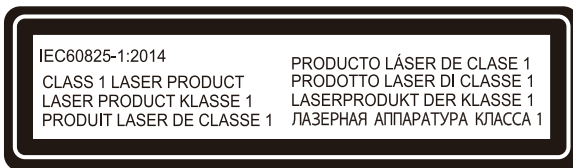

This product complies with EN60825-1:2014+A11:2021.
Ce produit est conforme à la norme EN60825-1:2014+A11:2021.
Este producto cumple con las normas EN60825-1:2014+A11:2021.
Dieses Produkt entspricht EN60825-1:2014+A11:2021.
Questo prodotto è conforme alla norma EN60825-1:2014+A11:2021.
Dit product voldoet aan EN60825-1:2014+A11:2021.
Ten produkt jest zgodny z normą EN60825-1:2014+A11:2021.

This product complies with EN50689:2021.
Ce produit est conforme à la norme EN50689:2021.
Este producto cumple con la norma EN50689:2021.
Dieses Produkt entspricht EN50689:2021.
Questo prodotto è conforme alla norma EN50689:2021.
Dit product voldoet aan EN50689:2021.
Ten produkt jest zgodny z normą EN50689:2021.

This product is designed to project images on a wall or screen.
Ce produit est conçu pour projeter des images sur un mur ou un écran.
Este producto está diseñado para proyectar imágenes en una pared o pantalla.
Dieses Produkt wurde entwickelt, um Bilder auf eine Wand oder eine Leinwand zu projizieren.
Questo prodotto è progettato per proiettare immagini su una parete o uno schermo.
Dit product is ontworpen om beelden op een muur of scherm te projecteren.
Ten produkt jest przeznaczony do projekcji obrazów na ścianie lub ekranie.

WARNING/ATTENTION/ADVERTENCIA/WARNUNG/AVVERTENZA/WAARSCHUWING/UWAGA

Do not look into the lens while in use.

Ne regardez pas dans l'objectif pendant son utilisation.

No mire directamente a la lente mientras está en uso.

Schauen Sie während der Verwendung nicht in die Linse.

Non guardare nell'obiettivo mentre è in uso.

Kijk niet in de lens terwijl deze in gebruik is.

Nie patrz w obiektyw podczas użytkowania.

CAUTION/PRUDENCE/PRECAUCIÓN/ACHTUNG/VOORZICHTIG/UWAGA

Use of controls or adjustments or performance of procedures other than those specified herein may result in hazardous laser radiation exposure.

L'utilisation de commandes ou de réglages ou l'exécution de procédures autres que celles décrites ici pourrait provoquer une exposition à des radiations dangereuses.

El uso de controles o ajustes o la ejecución de procedimientos distintos a los especificados en este documento puede resultar en la exposición peligrosa a la radiación láser.

Die Verwendung von Steuerungen oder Einstellungen oder die Durchführung von anderen als den hier angegebenen Bedienverfahren kann dazu führen, dass Sie gefährlicher Laserstrahlung ausgesetzt werden.

L'uso di controlli, regolazioni o prestazioni di procedure diversi da quelli specificati in questo manuale potrebbe causare una pericolosa esposizione alle radiazioni laser.

Het gebruik van andere instellingen of aanpassingen of de uitvoering van andere procedures dan hierin vermeld, kan leiden tot blootstelling aan gevaarlijke laserstraling.

Używanie elementów sterujących lub regulacji lub wykonywanie procedur innych niż określone w może spowodować narażenie na niebezpieczne promieniowanie laserowe.

Location information of the labels

Informations d'emplacement des étiquettes

Información de la ubicación de las etiquetas

Informationen zur Lage der Etiketten

Informazioni sulla posizione delle etichette

Locatie-informatie van de etiketten

Informacje o lokalizacji etykiet

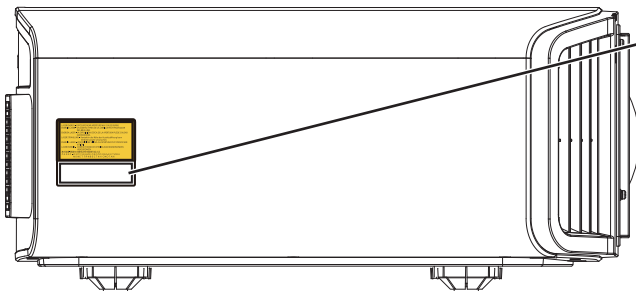

LASER CAUTION LABEL
ÉTIQUETTE DE MISE EN GARDE POUR LE LASER
ETIQUETA DE PRECAUCIÓN DEL LÁSER
LASERWARNSCHILD
ETICHETTA DI ATTENZIONE LASER
LASER WAARSCHUWINGSETIKET
ETYKIETA OSTRZEGAWCZA DOTYCZĄCA LASERA

CAUTION/PRUDENCE/PRECAUCIÓN/ACHTUNG/ATTENZIONE/VOORZICHTIG/UWAGA

- Do not stare into the projector beam at any distance from the projector.
- Ne regardez pas dans le faisceau du projecteur à n'importe quelle distance du projecteur.
- No mire directamente al haz del proyector a ninguna distancia del mismo.
- Blicken Sie nicht direkt in den Lichtstrahl vom Projektor, egal aus welcher Entfernung.
- Non fissare il raggio del proiettore a qualsiasi distanza dal proiettore.
- Kijk niet in de projectorstraal op enige afstand van de projector.
- Nie patrz w wiązkę projektora z jakiegokolwiek odległości od projektora.
- Be careful to beam from lens when using the remote control for starting the projector while in front of the projection lens.
- Faites attention au faisceau de l'objectif lorsque vous utilisez la télécommande pour démarrer le projecteur lorsque vous faites face à l'objectif de projection.
- Tenga cuidado con el haz de la lente cuando utilice el mando a distancia para encender el proyector mientras está frente a la lente de proyección.
- Achten Sie auf die Projektorlinse, wenn Sie die Fernbedienung zum Starten des Projektors verwenden, während Sie sich vor der Projektorlinse befinden.
- Prestare attenzione al raggio proveniente dall'obiettivo quando si usa il telecomando per avviare il proiettore mentre ci si trova davanti all'obiettivo di proiezione.
- Let op de straal van de lens wanneer u de afstandsbediening gebruikt om de projector te starten terwijl u zich voor de projectielens bevindt.
- Podczas używania pilota do uruchamiania projektora przed obiektywem projekcyjnym należy uważać, aby nie wchodzić w światło obiektywu.
- Do not use of optical aids such as binoculars or telescopes inside the beam.
- N'utilisez pas d'instruments optiques tels que des jumelles ou des télescopes à l'intérieur du faisceau.
- No use ayudas ópticas como prismáticos o telescopios dentro del haz.
- Verwenden Sie keine optischen Hilfsmittel wie Ferngläser oder Teleskope innerhalb des Lichtstrahls.
- Non utilizzare dispositivi ottici come binocoli o telescopi all'interno del raggio.
- Gebruik geen optische hulpmiddelen zoals een verrekijker of teelens binnen de straal.
- Nie używaj pomocy optycznych, takich jak lornetki lub lunety, wewnątrz wiązki.

Light source specifications

Spécifications de la source de lumière

Especificaciones de la fuente de luz

Spezifikationen der Lichtquelle

Specifiche della sorgente luminosa

Lichtbron specificaties

Specyfikacje źródła światła

112 W Laser diodes x 1, Wavelength 455nm, Maximum output is 112 W
Diodes laser 112 W x 1, longueur d'onde 455 nm, sortie maximale 112 W
Diodos láser de 112 W x 1, longitud de onda de 455 nm, salida máxima de 112 W
112 W Laserdiode x 1, Wellenlänge 455 nm, maximale Ausgabeleistung 112 W
Diodi laser x 1 112 W, lunghezza d'onda 455 nm, l'uscita massima è 112 W
112 W laserdioden x 1, golflengte 455 nm, maximale uitvoer is 112 W
Diody laserowe 112 W x 1, długość fali 455 nm, maksymalna moc wyjściowa to 112 watów

Beam divergence angle from lens of this unit

Angle de divergence du faisceau de l'objectif de cette unité

Ángulo de divergencia del haz desde la lente de esta unidad

Strahldivergenzwinkel der Linse dieses Geräts

Angolo di divergenza del fascio dall'obiettivo di questa unità

Straaldivergentiehoek ten opzichte van de lens van dit toestel

Kąt rozbieżności wiązki od obiektywu tego projektora

DLA-NZ900 series

$\alpha = 39^{\circ(*1)} - 71^{\circ(*2)}$

DLA-NZ800 series

$\alpha = 33.5^{\circ(*1)} - 62.7^{\circ(*2)}$

*1:Tele/Télé/Tele/Tele/Teleobiettivo/Tele/Teleobiektyw

*2:Wide/Large/Amplio/Weit/Grandangolo/Breed/Szeroki

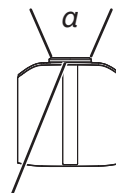

Laser emission port
Port d'émission laser
Puerto de emisión láser
Laseraustrittsöffnung
Porta emissione laser
Laseremissie-poort
Miejsce emisji lasera

IEC62471-5

**Location information of the mark / Informations d'emplacement du repère /
Información de la ubicación de la marca / Informationen zur Lage der Markierung /
Informazioni sulla posizione del marchio / Locatie-informatie van de markering /
Informacje lokalizacji etykiety**

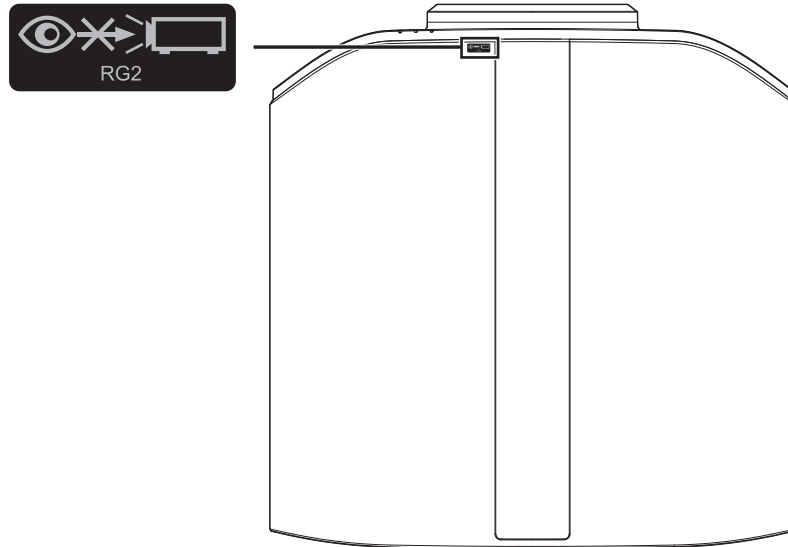

As with any bright light source, do not stare into the beam, RG2 IEC 62471-5:2015

Tout comme pour n'importe quelle source lumineuse brillante, ne regardez pas fixement le faisceau, RG2 IEC 62471-5: 2015

Al igual que con cualquier fuente de luz brillante, no mire directamente al haz, RG2 IEC 62471-5:2015

Wie bei allen hellen Lichtquellen, schauen Sie nicht in den Strahl, RG2 IEC 62471-5:2015

Come con qualsiasi fonte di luce intensa, non fissare il raggio, RG2 IEC 62471-5:2015

Net als bij andere felle lichtbron, kijk niet in de laserstraal, RG2 IEC 62471-5:2015

Jak w przypadku każdego jasnego źródła światła, nie patrz bezpośrednio w kierunku jego wiązki, RG2 IEC 62471-5:2015

Contents

Getting Started

Safety Precautions	2
Accessories/Optional Accessories	13
Check the Accessories	13
Optional Accessories	13
Controls and Features	14
Main Unit - Front	14
Main Unit - Bottom	14
Main Unit - Rear	15
Main Unit - Input Terminals	16
Remote Control	17
Loading Batteries into the Remote Control	18
Effective Range of Remote Control Unit	18
Menu	19

Set up







Installing the Projector	20
Precautions during Installation	20
Precautions during Mounting	21
Adjusting the Position	22
Connecting the Projector	23
Connecting to the HDMI Input Terminal (Digital Input)	23
Connecting to the LAN Terminal	24
Connecting to the RS-232C Terminal	24
Connecting to the TRIGGER Terminal	25
Connecting the Power Cord (Supplied Accessory)	25

Operate

Viewing Videos	26
Adjusting the Projector Screen	28
Adjusting the Lens According to the Projection Position	28
Adjusting the Screen Size (Aspect)	29
Viewing 3D Movies	30
Installing the 3D Synchro Emitter	30
Viewing 3D Movies	31
Adjusting 3D Movies	31

Adjust/Set

Selecting an Image Quality According to the Video Type	32
Setting the Picture Mode	32
Setting the Color Profile	34
Adjusting to your Preferred Color (Color Management)	37
Viewing HDR Content	38
HDR Feature on This Unit	38
Viewing HDR10+ Content	40
Setting Frame Adapt HDR	40
Using the "Theater Optimizer"	41
Adjusting Tone Mapping Automatically (Per Movie or Title)	43

Fine-tuning the Image Quality	46
Adjusting the Output Value of the Projected Image (Gamma/Tone Mapping)	46
Fine-tuning of Gamma/Tone Mapping to Preferred Settings	49
Reducing the Delay and After-image of Fast-moving Images (Motion Control)	51
Adjustments and Settings in the Menu	53
List of Menu Items	53
 Picture Adjust	56
 Input Signal	66
 Installation	69
 Display Setup	77
 Function	78
 Information	83

Maintenance

Maintaining the Cabinet and Remote Control	84
Cleaning and Replacing the Filter	84

Troubleshooting

Troubleshooting	86
When the Following Messages Appear... ..	91

Others

External Control	92
RS-232C Specifications	92
TCP/IP Connection	92
Command Format	93
Remote Control Code	94
Communications Example	95
Specifications	96
Software License Agreement	111
Important Notice concerning the Software	113
Index	114

Symbols used in this manual

NZ900 indicates a function that is supported by DLA-NZ900.

NZ800 indicates a function that is supported by DLA-NZ800.

RS4200 indicates a function that is supported by DLA-RS4200.

RS3200 indicates a function that is supported by DLA-RS3200.

Items not marked with any of the above symbols are supported by all models.

The illustrations of the projector unit used in this manual are those of DLA-NZ900. The appearance of the projector of other models may differ slightly.

Accessories/Optional Accessories

Check the Accessories

Lens cover 1 piece

* It is attached to the main unit at the time of shipment.

Remote control 1 piece

AAA-size batteries (for operational check) 2 pieces

Power cord (for USA) (about 2 m (about 78.7 in)) 1 piece

Power cord (for UK) (about 2 m (about 78.7 in)) 1 piece

Power cord (for EU) (about 2 m (about 78.7 in)) 1 piece

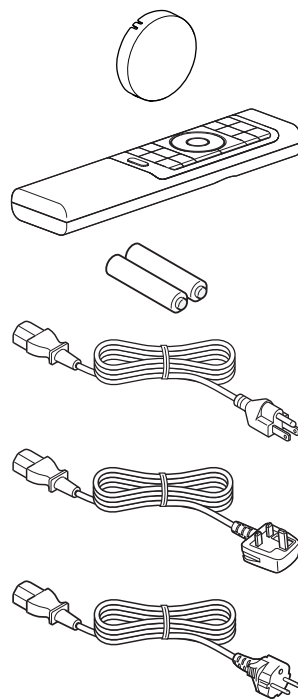

- Quick User Guide, safety precautions, warranty card, and other printed material are also included.
- Be sure to read the “Safety Precautions” before using this projector.

Optional Accessories

- 3D Glasses: model PK-AG3
- 3D Synchro Emitter: model PK-EM2

Controls and Features

Main Unit - Front

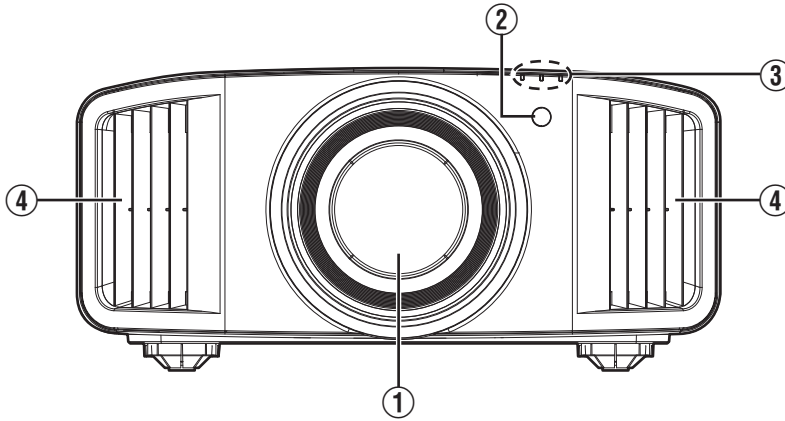

① Lens

This is a projection lens. Do not look through the lens while an image is projected.

② Remote Sensor (front)

Please aim the remote control at this area when using it.

* There is also a remote sensor at the rear.

③ Indicator

Refer to "Indicator Display on the Main Unit" P. 107.

④ Exhaust vent

Warm air is discharged to cool down the internal temperature.
Do not block the vents.

Main Unit - Bottom

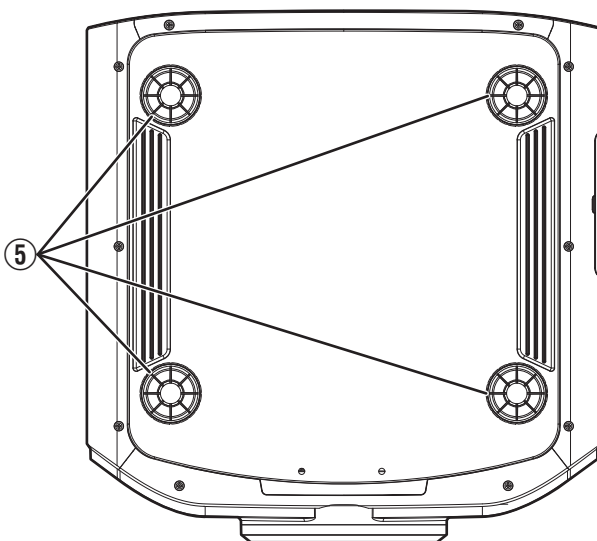

⑤ Feet

The height and angle of the projector can be adjusted by turning the foot. (0 to 5 mm (0 to 0.2 in)) (P. 22)

When the foot is removed, it can be used as the mounting hole for the ceiling mount bracket.

Main Unit - Rear

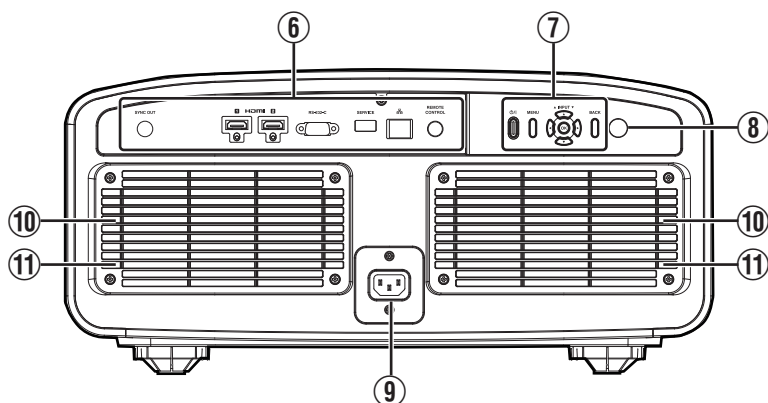

⑥ Input terminals

For details on the terminals, refer to “Main Unit -Input Terminals”P. 16.

⑦ Operation panel

For more details, please refer to the “Operation panel” in the diagram below.

⑧ Remote Sensor (rear)

Please aim the remote control at this area when using it.

* There is also a remote sensor at the front.

⑨ Power input terminal

Connect the supplied power cord to this terminal.

⑩ Air Inlets

The inlets take in air to cool down the internal temperature.

Do not block the inlet. Do not blow hot air on the inlet. Doing so may cause the unit to malfunction.

⑪ Filter Cover

To perform maintenance of the filter, remove this cover. (P. 84)

Operation panel

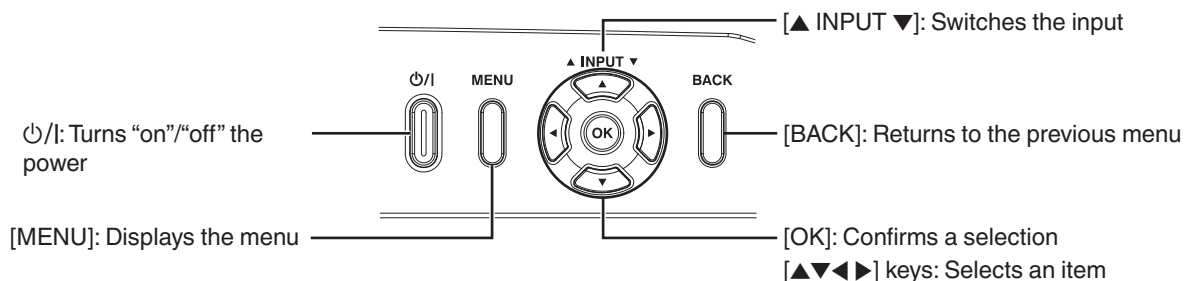

Main Unit - Input Terminals

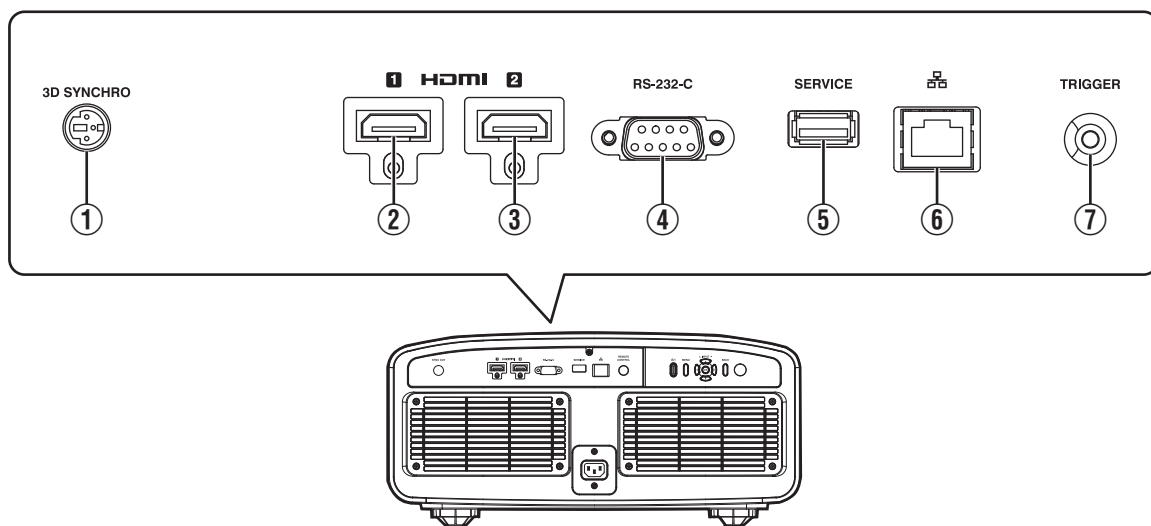

① [3D SYNCHRO] terminal

By connecting a 3D Synchro Emitter (sold separately) to this terminal, you can view 3D movies.

② [HDMI 1] input terminal

③ [HDMI 2] input terminal

For connecting to devices that support HDMI output. (P. 23)

④ [RS-232C] terminal (D-sub 9-pin male)

The projector can be controlled by connecting a PC to this terminal.

⑤ [SERVICE] terminal

For updating the software or using the backup setting feature via a commercially available USB flash drive.

⑥ [LAN] terminal (RJ-45)

The projector can be controlled by connecting it to a PC through the computer network for control commands to be sent to the projector.

⑦ [TRIGGER] terminal

Output terminal for DC 12 V, 100 mA power supply. It is used for sending output signals to control devices such as an elevating screen that is equipped with a trigger function.

Note that improper connection may damage the projector. (Tip=DC +12 V, Sleeve=GND)

Remote Control

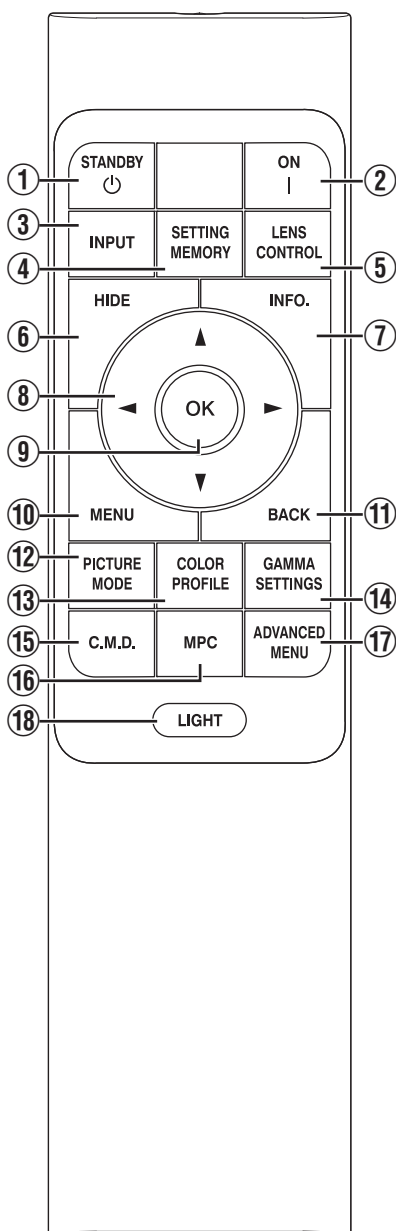

① [STANDBY]

Turns off the power. (P. 27)

② [ON]

Turns on the power. (P. 26)

③ [INPUT]

Switches the input to [HDMI 1] or [HDMI 2]. (P. 26)

④ [SETTING MEMORY]

Displays the installation mode selection menu.

⑤ [LENS CONTROL]

For adjusting focus, zoom, and shift. (P. 28)

- Pressing the button each time switches the setting in the following sequence: "Focus" → "Zoom" → "Shift"...

⑥ [HIDE]

Hides the image temporarily. (P. 26)

⑦ [INFO.]

Displays the information menu. (P. 83)

⑧ [▲▼◀▶] keys

For selecting an item.

⑨ [OK]

Confirms a selected item.

⑩ [MENU]

Displays the menu, or hides the menu if it is displayed.

⑪ [BACK]

Returns to the previous menu.

⑫ [PICTURE MODE]

Displays the picture mode selection menu. (P. 32)

⑬ [COLOR PROFILE]

Displays the color profile selection menu. (P. 34)

⑭ [GAMMA SETTINGS]

Displays the gamma setting menu.

⑮ [C.M.D.]

Displays the frame interpolation selection menu. (P. 52)

⑯ [MPC]

Displays the MPC setting menu. (P. 65)

⑰ [ADVANCED MENU]

Pressing the button each time toggles the menu display in the following sequence: "Picture Mode" → "Color Profile" → "Color Temp." → "Motion Control".

⑱ [LIGHT]

Illuminates the buttons on the remote control.

Loading Batteries into the Remote Control

Loading the batteries

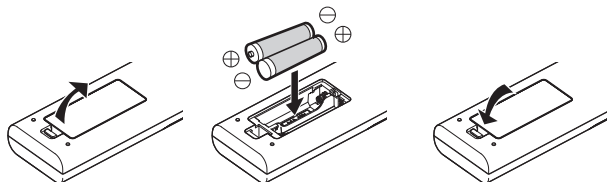

Removing the batteries

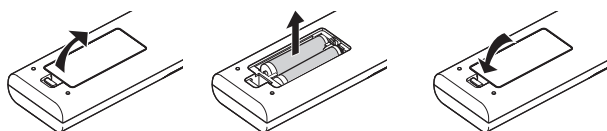

- If the remote control has to be brought closer to the unit to operate, it means that the batteries are wearing out. Replace the batteries with new ones (AAA).
- Insert the batteries according to the \oplus \ominus marks. Be sure to insert the \ominus end first. When removing the battery, do so from the \oplus end.
- If an error occurs while using the remote control, remove the batteries and wait for five minutes. Load the batteries again and operate the remote control.

CAUTION

- Do not put the remote control in a place with an exposure to direct sun light or high temperature. It may be deformed due to heat, or the internal components may be adversely affected resulting in fire hazard.
- Remove the batteries from the remote control when storing the remote control. Storing the remote control for a prolonged period without removing the batteries can cause battery leakage.
- Risk of explosion if battery is replaced by an incorrect type. Dispose of used batteries according to the instructions.
- If you want to dispose of the battery, please consider the collection systems or facilities for appropriate recycling.

Effective Range of Remote Control Unit

When aiming the remote control toward the sensor on this unit (front or rear), ensure that the distance to the sensor is within 7 m (23 ft).

If the remote control fails to work properly, move closer to this unit.

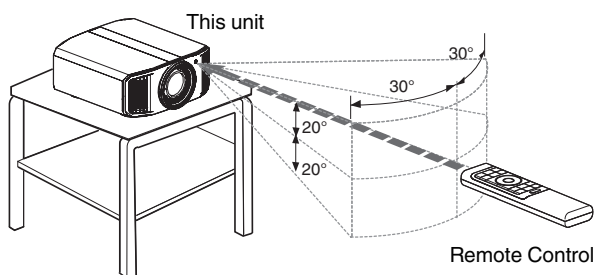

Control through reflection off a screen, etc.

Ensure that the total of distance A (between this unit and the screen) and distance B (between the remote control and the screen) is within 7 m (23 ft).

- * As the efficiency of signals reflected from the remote control unit varies with the type of screen used, the operable distance may decrease.

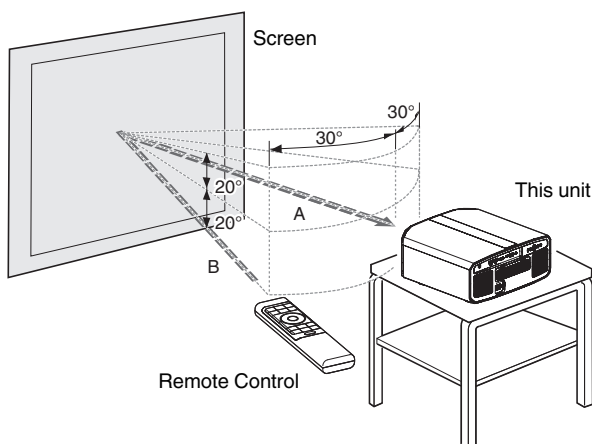

Menu

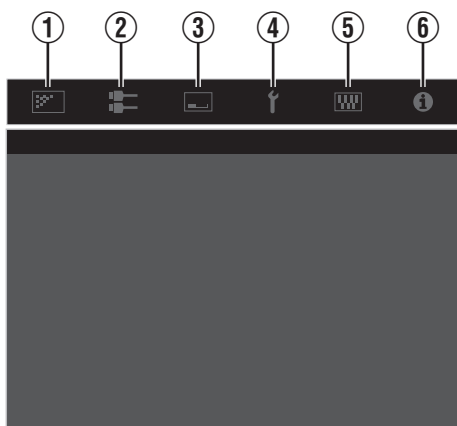

Select the icon at the top of the menu to display its corresponding setting item as shown below.

① Picture Adjust



② Input Signal



③ Installation



④ Display Setup



⑤ Function



⑥ Information



Installing the Projector

Precautions during Installation

Please read the following carefully before installing this unit.

When carrying this unit

This unit is heavy in weight. Please ensure that there are at least two persons carrying it. Projector weighs more than 20 kg (50 lbs).

Do not install at the following

This unit is a precision device. Please refrain from installing or using it at the following locations. Otherwise, it may cause fire or malfunction.

- Dusty, wet and humid places
- Places subject to oily smoke or cigarette smoke
- On top of a carpet or bedding, or other soft surfaces
- Places exposed to direct sunlight
- Places with a high or low temperature
- Do not install this unit in a room that is oily or subject to cigarette smoke. Even a small quantity of smoke or oiliness can have a long-term impact on this unit.
- * This unit produces a great amount of heat, and is designed to take in cool air to cool its optical components. Using the unit at the above locations may cause dirt to attach to the light path, thereby resulting in dark images or dull colors.
- * Dirt that sticks to the optical components cannot be removed.

Maintain clearance from the wall, etc.

As the unit discharges a large amount of heat, install it with adequate clearance from the surroundings as shown below.

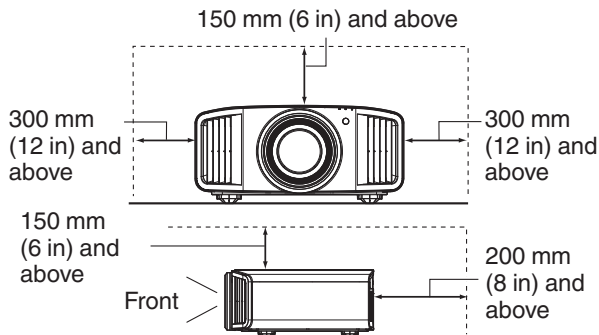

Leave the front area of the unit unblocked. If there is any obstructing object in front of the exhaust vent, hot air will flow back to the unit and cause it to heat up. Hot air flowing out of the unit may cast shadows on the screen (heat haze phenomenon).

Using the unit

Please refrain from projecting in the following circumstances. Otherwise, it may cause fire or malfunction.

- Projection with the unit stood vertically



- Projection with the unit inclined at an angle
Angle to horizontal plane: within $\pm 10^\circ$

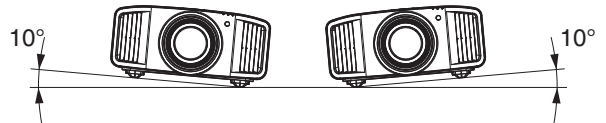

Vertical inclination: within $\pm 10^\circ$

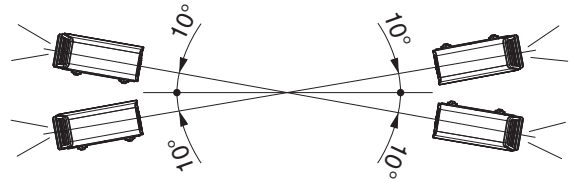

- Malfunction may occur if the angle is not set within the above-mentioned range.

Installing the screen

Install the unit and the screen such that they are perpendicular to each other.

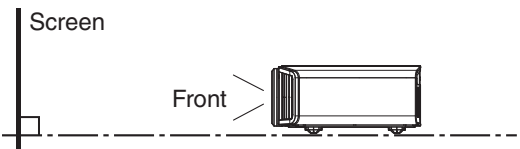

- Please choose a screen material with non-uniform patterns. Uniform patterns such as checks may cause interference patterns to occur.
- In this case, you can change the size of the screen to make the interference patterns less noticeable.

Using the projector at a high altitude

When using this unit at a location that is higher than 900 m (3,000 ft) above sea level (low air pressure), set the "High Altitude Mode" to "On". (P. 81)

Set up

Precautions during Mounting

Securing (mounting) the projector

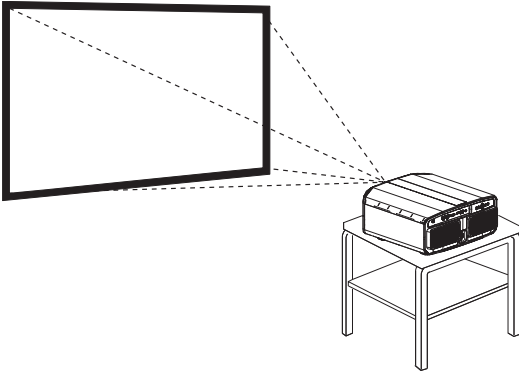

- When this unit is to be mounted to a fixed position for use, install it horizontally.
- Make sure to secure the main unit to prevent accidents such as during an earthquake.

Securing with screws

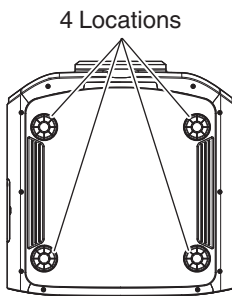

Remove the four feet at the bottom, and fasten using the screws (M5 screws, 20 to 25 mm (0.8 to 1.0 in)).

- * Using screws other than ones mentioned may damage the unit or cause the unit to fall from the mount.

Securing the projector (ceiling mount)

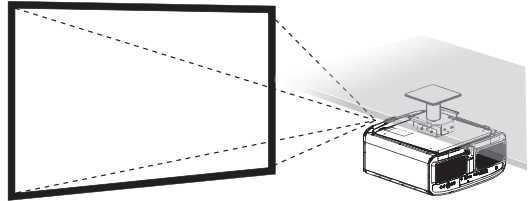

- Be sure to ask your dealer to install the unit for you. Installing the unit on your own may cause the unit to fall resulting in injury.
- Take the necessary actions to prevent the main unit from falling off such as during an earthquake.
- Regardless of the warranty period, JVC is not liable for any product damage caused by mounting the unit with non-JVC ceiling fittings or to an environment that is not suited for ceiling mount.
- When using the unit with it suspended from a ceiling, pay attention to the surrounding temperature. When a heater is in use, the temperature around the ceiling may be higher than expected.
- To attach the unit to the ceiling mount bracket, set the torque between the range of 1.5N m to 2.0N m. Tightening with torque exceeding the above range may cause damage to the unit, which may result the unit to fall.
- Use a projector mount that supports more than the weight of the projector.
- When reusing the ceiling mount bracket of an old model, consult the specialist to check if there are any issues with the surrounding space and increase in weight.
- Install the outlet at an accessible height to unplug from the wall. Or install the circuit breaker at an accessible height to shut down the projector. If you need information, please consult your authorized dealer or specialist.

Adjusting the Position

Adjusting the elevation angle of the projector

The height and inclination of the unit (0 to 5 mm (0 to 0.2 in)) can be adjusted by turning the feet. Lift the unit and adjust the four feet.

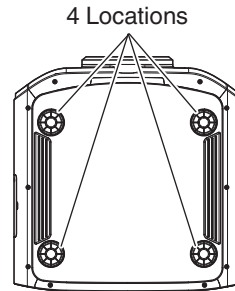
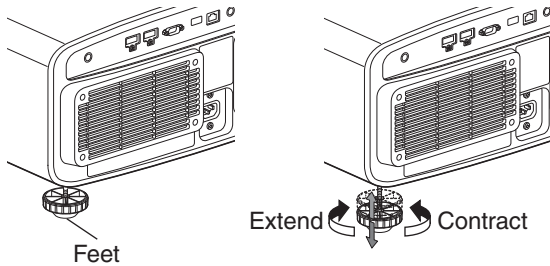

Adjusting the position of the image

By using the lens shift feature of this unit, you can shift the image upward/downward or to the left/right. Set it to your preferred position.

➔ “Adjusting the Lens According to the Projection Position” (P. 28)

Horizontal Position

Vertical Position: 0% (Center)

Up to about 43% **NZ900 RS4200** and 34% **NZ800 RS3200** of the projected image *

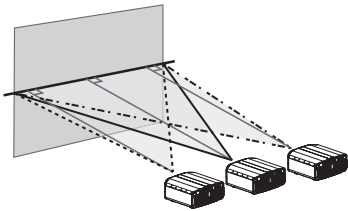

Lens Shift Range (16:9)

NZ900 RS4200

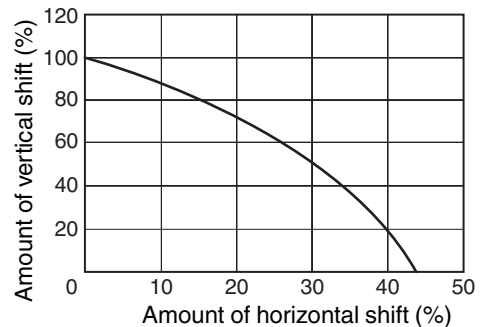

Vertical Position

Horizontal Position: 0% (Center)

Up to about 100% **NZ900 RS4200** and 80% **NZ800 RS3200** of the projected image *

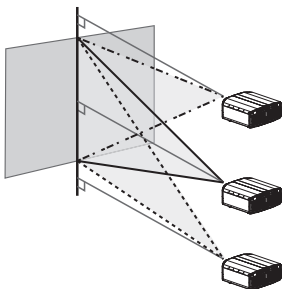

NZ800 RS3200

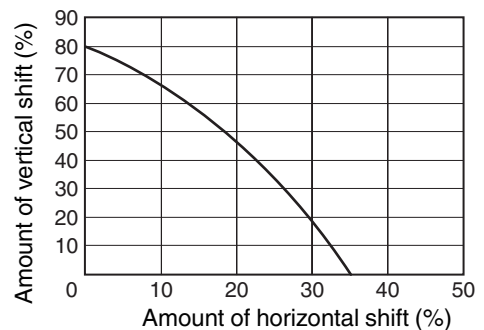

* 16:9 image

- The maximum vertical shift varies with the amount of horizontal shift. Similarly, the maximum horizontal shift also changes with the amount of vertical shift.
- The values on the graph are intended as a guide. Use them for reference during installation.

Connecting the Projector

- Do not turn on the power until connection is complete.
- The connection procedures differ according to the device used. For details, please refer to the instruction manual of the device to be connected.
- This projector is used for projecting images. To output the audio of connected devices, please connect a separate audio output device, such as an amplifier or speaker.
- Projector has no audio pass through or eARC output.
- The images may not be displayed depending on the devices and cables to be connected. When using an HDMI cable (sold separately), make use of one with the Ultra High Speed HDMI Cable certification (supports 48 Gbps).
- Also, please refer to "HDMI EDID Setting" P. 68.
- Some cables cannot be connected to this unit due to the size of their connector cover.
- Configuration of a network password is necessary before connecting to the LAN terminal. For details, refer to "Network Password" P. 79.

Connecting to the HDMI Input Terminal (Digital Input)

Connecting via HDMI cable

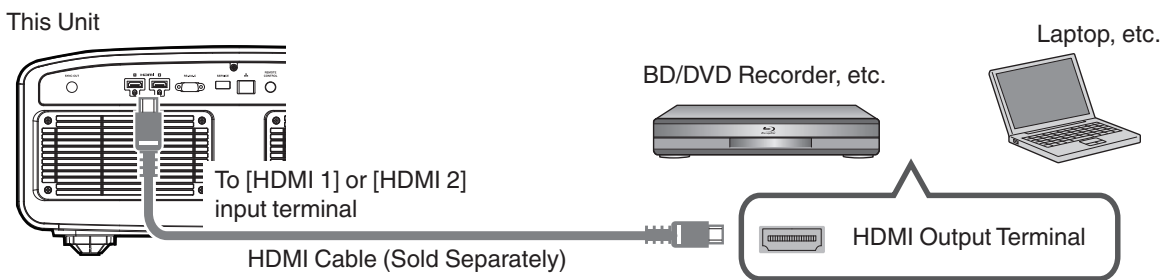

- If noise occurs, move the laptop away from this unit.

Connecting through an AV amplifier

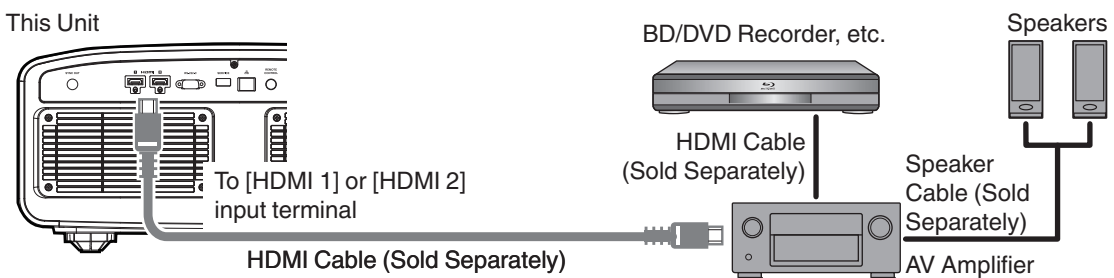

- If the source device is connected to the projector through an intermediate device such as an AV amplifier or divider, the video image may not appear depending on the specifications of the intermediate device. In this case, connect the source device directly to the projector, and check whether the video image is displayed.

Connecting via HDMI-DisplayPort conversion cable

This Unit

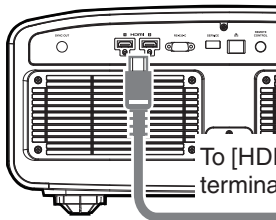

To [HDMI 1] or [HDMI 2] input terminal

HDMI-DisplayPort Conversion Cable (Sold Separately)

Desktop PC, etc.

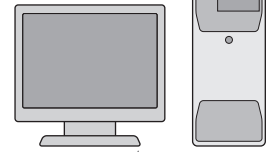

DisplayPort Terminal

- If noise occurs, move the desktop PC away from this unit.
- If the video is not displayed, try to reduce the length of the cable or lower the resolution of the video transmitting equipment.

Connecting to the LAN Terminal

This Unit

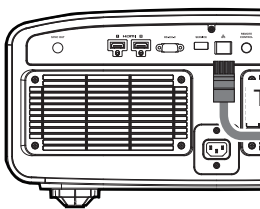

To [LAN] Terminal

Connection Cable
(Sold Separately)

Desktop PC, etc.



Network



Server

- The network is used to control this unit. It is not used for sending or receiving video signals.
- Please contact your network administrator for information concerning the network connection.
- Configuration of a network password is necessary before connecting to the LAN terminal. (P. 79)
- Set "ECO Mode" to "Off" if LAN communication is performed in the Standby mode. (P. 78)
- For more information on control, please refer to "External Control" P. 92.

Connecting to the RS-232C Terminal

This Unit

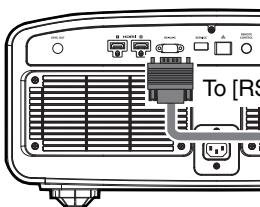

To [RS-232C] Terminal

RS-232C Connection
Cable (Sold Separately)

Laptop, etc.



RS-232C Terminal

- Set "ECO Mode" to "Off" if RS-232C communication is performed in the Standby mode. (P. 78)
- For more information on control, please refer to "External Control" P. 92.

Connecting to the TRIGGER Terminal

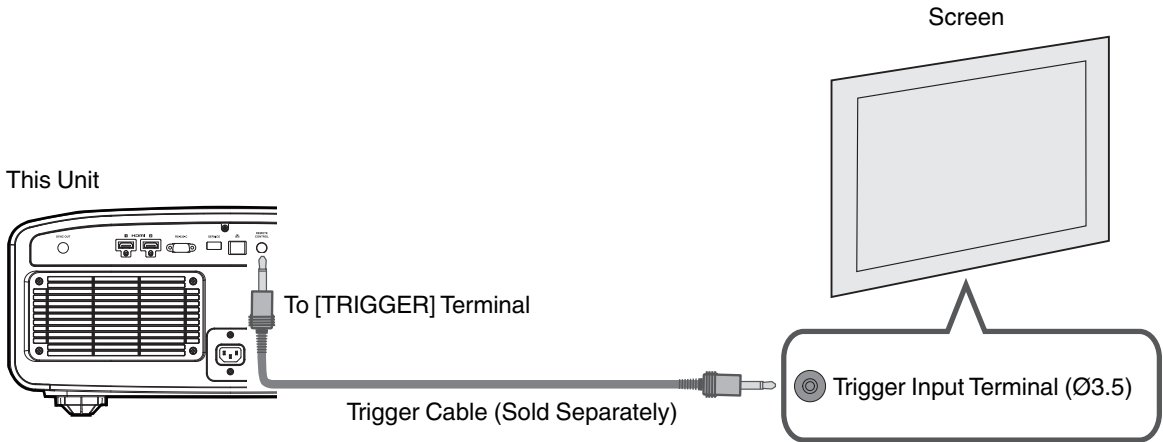

- Do not use it to supply power to other devices.
- Connecting to the audio terminal of another device may cause the device to malfunction or break down.
- Using beyond the rated value will cause the unit to malfunction.
- The trigger terminal outputs a voltage of 12 V. Exercise adequate caution to prevent short circuit.
- The factory setting is "Off". To change the setting, configure the "Trigger" item in the menu (P. 78).

Connecting the Power Cord (Supplied Accessory)

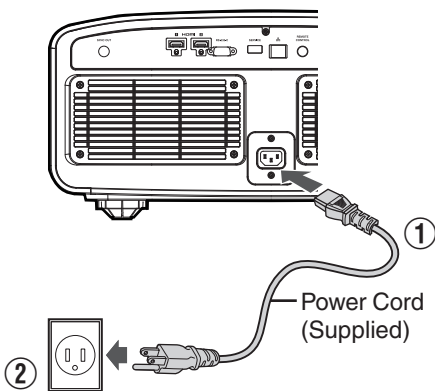

- ① Connect the power cord supplied to the power input terminal on the main unit
- ② Insert the supplied power plug into the wall outlet.

Precautions to prevent fire and electric shock

- The power consumption of this unit is large. Please connect it directly to the wall outlet supporting 15 A.
- When you are not using the projector, please unplug the power cord from the outlet.
- Connect it using only the power cord supplied.
- Do not use a voltage other than the indicated power voltage.
- Do not damage, break or modify the power cord. Do not place a heavy object on the power cord, or heat or pull it. Doing so may damage the power cord.
- Do not unplug the power cord with wet hands.

Viewing Videos

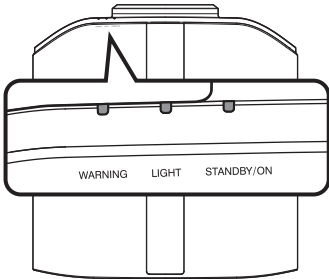
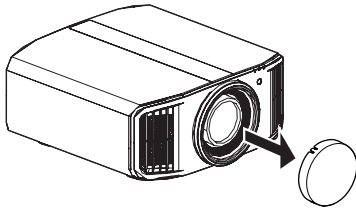

Remote Control

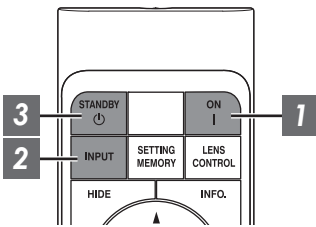

This unit

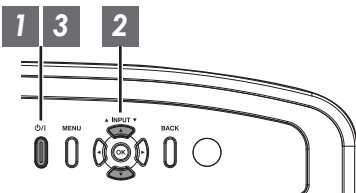

MEMO

- Make sure to remove the lens cover.
- Connect the power cord, and ensure that the “STANDBY/ON” indicator lights up in red.
- During standby in the “ECO Mode”, the “STANDBY/ON” indicator does not light up even when the power cord is correctly connected. In this case, cancel the standby mode by pressing any button on the remote control unit, or use the \odot /I button on the projector unit when you are turning on the power.

1 Turn on the power

Remote control: press the I [ON] button

Projector unit: press the \odot /I button

- The “STANDBY/ON” indicator light switches from red (light off in “ECO Mode”) to green (light goes off after the unit starts up).

“STANDBY/ON” lights up (red)
In standby state



“STANDBY/ON” lights up (green)
When light source is starting up



“STANDBY/ON” light off
When in “ECO Mode”



2 Choose the image to project

Remote control/projector unit: press the [INPUT] button to switch the input

- Play back the selected device to project the image.

To hide the image temporarily

Press the [HIDE] button on the remote control

- The “STANDBY/ON” indicator light starts to blink in green.
- Press the [HIDE] button again to resume display of the image.
- The power cannot be turned off when the image is temporarily hidden.
- The light source is turned off when the “Hide Mode” is set to “On” in the OSD menu.

3 Turn off the power

Remote control: press the ⏻ [STANDBY] button

Projector unit: press the ⏻/I button

- While the “Are you sure you want to turn off?” message is displayed, press the button again.
- The light of the LD block goes off, and the “STANDBY/ON” indicator switches from a green light to a red blinking light.
- After the light goes off, the fan will run for approximately 10 seconds to cool down the LD block (Cool-down mode). Do not disconnect the power cable while cooling is in progress.
- Depending on the settings of the projector unit, cooling time may be about 30 seconds longer due to internal processing.
- After cooling is complete, the “STANDBY/ON” indicator switches from a blinking red to a solid red light.

“STANDBY/ON” blinking (red)
In the Cool-down mode



“STANDBY/ON” lights up (red)
In standby state



CAUTION

- The power cannot be turned on again while cooling is in progress.
- Pull out the power plug when the unit is not to be used for a prolonged period of time.
- If the indication of indicator differs from the description, refer to “Indicator Display on the Main Unit”P. 107 for details.

Adjusting the Projector Screen

Adjusting the Lens According to the Projection Position

Operate

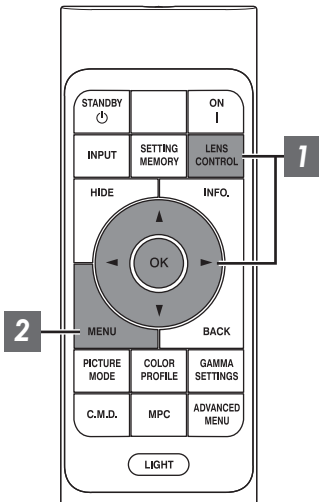

1 Press the [LENS CONTROL] button, and use the [▲▼◀▶] keys to adjust Focus, Zoom (screen size), and Shift (screen position)

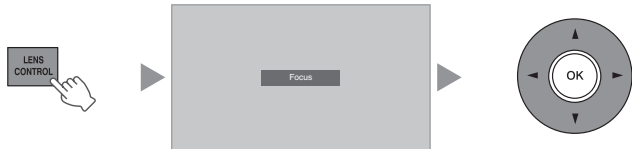

- Pressing the [LENS CONTROL] or [OK] button each time switches the mode in the following sequence: “Focus” → “Zoom” → “Shift” → “Focus”...
- Operation of the lens control feature is disabled when the lens lock is set to “On”. (P. 70)
- For more detailed information, please refer to “Lens Control”P. 70.



Focus Adjustment

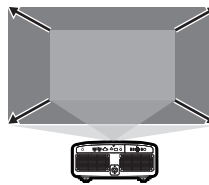

Zoom (Screen Size) Adjustment

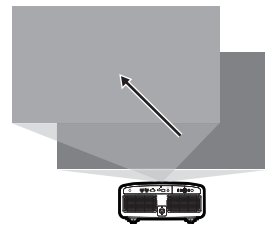

Shift (Screen Position) Adjustment

2 Press the [MENU] or [BACK] button to end adjustment

Adjustment Pattern Displayed on the Adjustment Screen

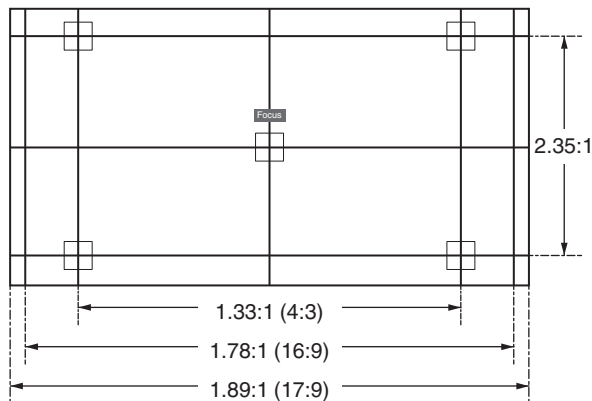

Adjust the display according to the viewing angle of the respective aspect ratios for the adjustment patterns.

* This is not displayed when “Image Pattern” is configured to “Off”.

Adjusting the Screen Size (Aspect)

The screen size of the projected image can be adjusted optimally according to the original screen size (aspect) that has been input.

- 1 Press the [MENU] button to display the menu
- 2 Select “Installation” → “Aspect” in the menu, then select the setting and press [OK]

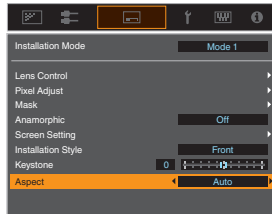

Setting	Description
Zoom	Magnifies the input image horizontally to the maximum while maintaining its aspect ratio for display. Part of the image that runs off the edge vertically will not be displayed. * Displayed in a width of 3840 pixels when in the 3D mode.
Auto	Magnifies the input image horizontally or vertically to the maximum while maintaining its aspect ratio for display.
Native	Any image below 1920x1080 and 2048x1080 will be scaled 4 times the native resolution of the source. Any source above 1920x1080 will be shown without any scaling. *2048x1080 the exception.

- 3 Press the [MENU] button to exit

* When “Picture Mode” is configured to “FILMMAKER MODE”, “Aspect” is fixed at “Auto”.

Example of input image and screen size

Setting \ Input Image Size	Zoom	Auto	Native
720x480			
1920x1080			

Viewing 3D Movies

By using the 3D Glasses (PK-AG3) and 3D Synchro Emitter (PK-EM2), both sold separately, you can enjoy 3D video images.

* The PK-AG3 glasses may not work with certain polarized/Ambient Light Rejecting screen materials. The image may be excessively dark when viewed through the glasses. Please use 3rd party circular polarized glasses for these types of applications.

Installing the 3D Synchro Emitter

1 Connect 3D Synchro Emitter to the [3D SYNCHRO] terminal on the main unit

Installation Example

This Unit

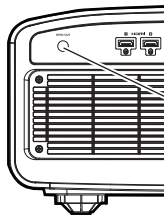

3D Synchro Emitter
PK-EM2



3D Glasses
PK-AG3

Operate

Viewing 3D Movies

7

Connect this unit to a 3D-compatible HDMI device, and turn on the power to play back the 3D video image

- For details on how to play back 3D video images, please refer to the instruction manual of the player or recorder in use.
- This unit supports the following 3D formats.
 - Frame packing
 - Side-by-side
 - Top-and-bottom

Setting the 3D format

- 1 Select “Input Signal” → “3D Setting” → “3D Format” in the menu to switch the format

Format	Description
Auto	Automatically determines and sets the format upon receiving 3D signal.
Side by Side	Select this setting if the 3D input signal is of the side-by-side format.
Top and Bottom	Select this setting if the 3D input signal is of the top-and-bottom format.
2D	Select this setting if 2D images are falsely recognized as 3D ones.

- * If a signal cannot be displayed as 3D image, selecting the format does not switch the signal to a 3D image. For more information on possible input signals, please refer to “Types of Possible Input Signals” P. 106.
- * In the default setting, “3D Format” is set to “Auto” for automatic projection of 3D images.

2

Turn on the power of the 3D Glasses and put them on

Adjusting 3D Movies

3D video images may appear differently to different viewers. It may also be affected by your physical condition at the time of viewing. You are therefore recommended to adjust the video images accordingly.

7

Select “Input Signal” → “3D Setting” from the menu

Adjusting parallax (Parallax)

Adjust the displacement of the image for the left and right eyes separately to obtain the best 3D effect.

- To do so, use the ◀▶ keys to move the cursor.
- Setting range: -15 to +15

Adjusting crosstalk (Crosstalk Cancel)

Double images (overlapping of the left image with the one on the right or vice versa) can be reduced to deliver a clear quality.

- To do so, use the ◀▶ keys to move the cursor.
- Setting range: -8 to +8

2

Press the [MENU] button to exit

MEMO

- The “3D Setting” settings are saved separately for each input terminal. The name of the currently selected input terminal is shown at the top right corner of the “3D Setting” menu.
- To switch to configure the settings for a different input terminal, press the [INPUT] button on the remote control unit, or press the ↑↓ key on the projector unit after turning off the menu screen.

Selecting an Image Quality According to the Video Type

Setting the Picture Mode

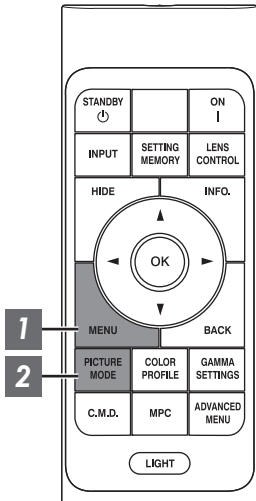

- Press the [MENU] button to display the menu, followed by using the ↑ ↓ keys to select “Content Type”. Next, press [OK]. Doing so enables selection of a picture mode that suits the content for viewing.

Item	Description
Auto	Switches the video type automatically according to the input video system. After switching automatically, the picture mode switches to the setting preconfigured in “Auto Pic.Mode Select”. (“Auto Pic.Mode Select”P. 67)
SDR	Picture mode suitable for viewing SDR content. SDR content includes 2D and 3D content.
HDR10+	Picture mode suitable for viewing HDR10+ content.
HDR10	Picture mode suitable for viewing HDR10 content.
HLG	Picture mode suitable for viewing HLG content.

Configuring the video type to “Auto” automatically switches Content Type according to the input video system.

HDMI Packet Information	Content Type
HDR10+	HDR10+
ST2084	HDR10
HLG	HLG
Other than the above/Out of Range/No Signal	SDR

Press the [PICTURE MODE] button, use the [▲▼] keys to select “Picture Mode” and press [OK]

- You can also perform the setting by pressing the [MENU] button to display the menu followed by selecting “Picture Adjust” → “Picture Mode”.

Video Type (*)	Available Picture Modes	Description
SDR	Natural	Image quality that focuses on natural color and gradation reproduction. Suitable for drama footage, etc.
	Cinema	Reproduces the image in vivid colors. Suitable for all movies.
	Film	Reproduces faithfully the texture of movie films.
	Vivid	Bright and rich colors with vivid image quality. Suitable for viewing in a slightly bright environment, such as living room.
	FILMMAKER MODE	Picture mode that supports the FILMMAKER MODE™ of the UHD Alliance standard.
	User 1 to User 3	Enables user-defined image quality data to be saved and retrieved.
HDR10+	HDR10+	Picture mode suitable for viewing HDR10+ content. Tone mapping is optimally performed for each scene according to the dynamic metadata to faithfully reproduce HDR video images according to the intentions of the video producer.
HDR10	Frame Adapt HDR 1 to Frame Adapt HDR 3	Picture mode that analyzes and automatically adjusts the HDR Tone Mapping of each frame in the HDR10 content. It employs an original analysis algorithm that allows users to enjoy HDR10 content with different levels of brightness in the optimal picture quality.
	HDR10	Making full use of the wide color gamut and contrast, this mode is suited for viewing HDR10 content such as Ultra HD Blu-ray and streaming service.
	FILMMAKER MODE	Picture mode that supports the FILMMAKER MODE™ of the UHD Alliance standard.
HLG	HLG	Image quality suited for viewing content produced in Hybrid Log-Gamma, a HDR standard for HLG broadcasting.
HDR10/HLG	User 4 to User 6	Enables user-defined image quality data to be saved and retrieved.

* Video type that is automatically determined if Content Type is configured to Auto

Setting the Color Profile

By setting the “Color Profile” (color space information) according to the “Picture Mode”, you can fine-tune the image quality according to the movie you are viewing.

* When “Picture Mode” is set to “HDR10+”, the setting is fixed at BT.2020(Normal).

1 After configuring “Picture Mode” (P. 32), press the [COLOR PROFILE] button, use the [▲▼] keys to select “Color Profile”, followed by pressing [OK]

- You can also perform the setting by pressing the [MENU] button to display the menu followed by selecting “Picture Adjust” → “Color Profile”.
- The selectable “Color Profile” settings vary according to “Picture Mode”.

“Color Profile”

Color Profile	Description
Auto	Switches the color profile automatically based on the color gamut information of the input content.
BT.709	Color space that is suitable for BT.709.
BT.2020(Wide)	Color space that is suitable for HDR viewing. The cinema filter is configured to Wide. *1
BT.2020(Normal)	Color space that is suitable for BT.2020. The cinema filter is configured to Wide. * *1
DCI	Color space that is suitable for DCI.
Video	Color gamut that reproduces video footage such as dramas and live images in bright and vivid colors.
Anime.	Color space that is suitable for CG animation works. Ideal for animated works with bright colors.
Cinema	Cinema-specific color gamut that achieves a balance between increased brightness and color vividness.
Film 1	Color space that is close to the characteristics of Eastman Kodak Company movie films.
Film 2	Color space that is close to the characteristics of FUJIFILM Corporation movie films.
Off (Wide)	Disables color space adjustment. The cinema filter is configured to Wide. *
Off (Normal)	Disables color space adjustment. The cinema filter is configured to Normal. *
Vivid	Bright and rich colors. Suitable for viewing in a slightly bright environment, such as living room.
Custom1 to Custom4	For saving the color profile data created using the projector calibration software.

* Normal cinema filter is a setting that prioritizes brightness and is best suited for video content or movies with an apparent peak.

Wide cinema filter is a setting that prioritizes color reproduction and allows users to enjoy the wide color gamut of HDR. Recommended for all kinds of movie content.

List of selectable “Color Profile” according to “Picture Mode”

Picture Mode	Color Profile
Natural	Auto
	BT.709
	BT.2020(Wide)
	BT.2020(Normal)
	DCI
	Video
	Anime. Cinema
Cinema	BT.709
	BT.2020(Wide)
	BT.2020(Normal)
	DCI
	Video
	Anime. Cinema
	Film
Film 2	
Vivid	Vivid
HDR10+	BT.2020(Normal)**
FILMMAKER MODE (When Content Type is configured to “SDR” or “Auto (SDR)”)	Auto
FILMMAKER MODE (When Content Type is configured to “HDR10” or “Auto (HDR10)”)	BT.2020(Wide)
	BT.2020(Normal)
Frame Adapt HDR 1 to Frame Adapt HDR 3	BT.2020(Wide)
	BT.2020(Normal)
HDR10 HLG	Auto
	BT.709
	BT.2020(Wide)
	BT.2020(Normal)
	DCI

(Continue on next page)

Picture Mode	Color Profile
User 1 to User 3	Auto
	BT.709
	BT.2020(Wide)
	BT.2020(Normal)
	DCI
	Video
	Anime.
	Cinema
	Off (Wide)
	Off (Normal)
	Custom1 to Custom4
	User 4 to User 6
BT.709	
BT.2020(Wide)	
BT.2020(Normal)	
DCI	
Off (Wide)	
Off (Normal)	
Custom1 to Custom4	

* When "Picture Mode" is configured to "HDR10+", "Color Profile" is fixed at BT.2020(Normal) and the color profile function cannot be used.

Adjusting to your Preferred Color (Color Management)

Based on the setting of the selected “Color Profile”, you can adjust each of the following colors according to your preference: Red, Yellow, Green, Cyan, Blue, and Magenta.

1 Press the [MENU] button to display the menu, followed by selecting “Picture Adjust” → “Color Profile” to display the “Color Profile” menu

2 Set “Color Management” to “On”, and press the [OK] button



3 Adjust to the preferred color

① Select “Color Selection”, and press the ◀▶ keys to select the color to adjust

- For color adjustment, select the color from the following: “Red”, “Yellow”, “Green”, “Cyan”, “Blue”, “Magenta”.

② Adjust the selected color

Item	Setting Range	Description
Hue	-30 to 30	Adjusts the hue (color tone).
Saturation	-30 to 30	Adjusts the color saturation (vividness). -30 (dull) to +30 (vivid)
Brightness	-30 to 30	Adjusts the brightness. -30 (dark) to +30 (bright)

- Selecting “Reset” resets all the adjustment data.
- Pressing the [HIDE] button on the remote control enables you to check the image before adjustment. Press the [HIDE] button again to return to the adjustment screen.



4 Press the [MENU] button to exit

Viewing HDR Content

When viewing HDR content, making adjustments according to the content and viewing environment allows the images to be played back in higher quality.

What is HDR content?

HDR (High Dynamic Range) refers to images with a significant difference in brightness between the highlight and shadow areas (dynamic range). It is a technology that enables faithful and realistic reproduction of the original colors as well as glitter and details of shadows that could not be expressed by the conventional SDR (Standard Dynamic Range). The international standard for HDR is set forth in the ITU-R (International Telecommunication Union – Radiocommunication Sector) BT.2100. Enhancements have been made in many aspects compared to ITU-R BT.709, which was the conventional Full HD standard.

HDR can largely be divided into two different formats, namely HDR10 which is employed by UHD-BD and video streaming services, and Hybrid Log-Gamma which is employed for broadcasting. Compared to the conventional SDR, the standard HDR format HDR10 delivers a higher resolution, higher luminance and higher gradation as well as a wider color gamut to reproduce images more realistically in combination with the wide dynamic range. HDR10+, which is an extension of the HDR10 standard, embeds brightness information for each scene into the content as metadata. This allows tone mapping based on the scene, and makes it possible to faithfully reproduce the HDR video according to the intention of the producer.

➔ “HDR Feature on This Unit” (P. 38)

HDR Feature on This Unit

This unit is equipped with features for enjoying HDR images in better quality with ease.

Content Type

HDR format contents cannot be displayed correctly unless it is viewed in the appropriate picture mode. Configuring “Content Type” to “Auto” on this unit enables selection of only the “Picture Mode” suited for the content. Doing so allows users to enjoy optimal HDR videos without the need to deal with the complex settings.

* The picture mode might not switch automatically depending on the playback content and player in use.

➔ “Content Type” (P. 56)

HDR10 Mastering Information Display

Mastering information contained in the content can be displayed when playing HDR10 content such as those on UHD Blu-ray. With this information, you can be sure that HDR content is being played back. Also, based on the information of Max CLL and Max FALL, customized changes according to the content can be performed by adjusting the picture tone.

* Mastering information might not be displayed depending on the playback content and player in use.

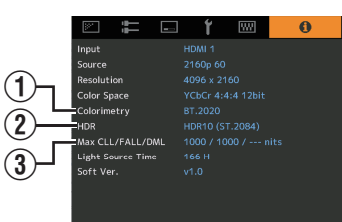

① Colorimetry

Displays the color gamut information of the input signals.

② HDR

Displays the gamma information when HDR packet is received.

③ Max CLL/FALL/DML

Displays the mastering information of the content during HDR playback.

Max CLL: Maximum Content Light Level

Max FALL: Maximum Frame Average Light Level

Max DML: Brightness of the master monitor during content production

➔ “ Information” (P. 83)

Frame Adapt HDR (Dynamic Tone Mapping)

Each HDR movie or title is designed for peak brightness that will change from scene by scene or frame by frame. The “Frame Adapt HDR” feature enables the HDR tone mapping to be adjusted in real time automatically. This feature does not require any mastering information, it will analyze each frame of the HDR image in real time to achieve the almost same mastering information as the original director’s cut. This feature works across all HDR platforms from streaming devices to 4K UHD players.

➔ “Setting Frame Adapt HDR” (P. 40)

Theater Optimizer

The brightness of the projector screen varies not only with the screen size, gain and projection distance but also with the frequency of use and various settings. When “Picture Mode” is configured to “Frame Adapt HDR”, the “Theater Optimizer” function automatically analyzes the environment in which the projector is used and adjusts the tone mapping to allow viewing in the appropriate brightness according to the details of the screen entered in advance. This allows you to enjoy HDR video optimized for your personalized usage environment.

Auto Tone Mapping

Grading varies diversely with the video work, with some content being made brighter and others darker. By configuring “Tone Mapping” to “HDR(Auto)”, gamma adjustment is performed automatically to achieve the optimal brightness based on the mastering information (Max CLL/Max FALL) contained in the HDR10 content. Also, by configuring the base brightness level in “Mapping Level”, you can enjoy the optimal picture quality according to the screen size and viewing environment.

* This feature may not be available depending on the playback content and player in use.

➔ “Adjusting Tone Mapping Automatically (Per Movie or Title)” (P. 43)



Fixed Tone Mapping



Tone Mapping“HDR(Auto)”

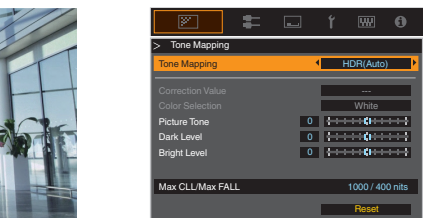

* The photos are for illustrative purposes only.

Manual Tone Mapping Adjustment

In addition to the “Auto Tone Mapping” function, tone mapping adjustment can also be performed manually on this unit. Fine-tuning according to the playback content and viewing environment is possible by using “Picture Tone” to determine the overall brightness, “Dark Level” to adjust the gradation of shadows, and “Bright Level” to adjust the gradation of highlights.

➔ “Performing Tone Mapping Manually” (P. 44)



Viewing HDR10+ Content

1 Press the [MENU] button to display the menu, and set “Content Type” to “Auto” or “HDR10+” in the “Picture Adjust” menu.

2 Enter the HDR10+ content.

- When “Input Signal” → “HDMI EDID Setting” → “HDR10+” is configured to “Off”, the receiving of HDR10+ is disabled. To enjoy HDR10+ content, configure to “On”. (“HDMI EDID Setting”P. 68)

Setting Frame Adapt HDR

1 Press the [MENU] button to display the menu, and set “Content Type” to “Auto” or “HDR10” in the “Picture Adjust” menu.

2 Configure “Picture Mode” to “Frame Adapt HDR 1”~“Frame Adapt HDR 3” in the “Picture Adjust” menu.

- You can also configure the setting by pressing the [PICTURE MODE] button and using the ↑ ↓ keys to select “Frame Adapt HDR 1”~“Frame Adapt HDR 3”. (P. 32)
- Enter the HDR10 content when “Picture Mode” is configured to “Auto”.

3 Configure to “HDR Processing” in the “Picture Adjust” menu. (“HDR Processing”P. 63) *

4 Configure to “HDR Quantizer” in the “Picture Adjust” menu. (“HDR Quantizer”P. 63) *

* This can be configured only when “Picture Mode” is configured to “Frame Adapt HDR 1”~“Frame Adapt HDR 3”.

MEMO

- If you wish to watch HDR10 content in the “Frame Adapt HDR 1”~“Frame Adapt HDR 3” picture mode, we recommend that you enable automatic switching to “Frame Adapt HDR 1”~“Frame Adapt HDR 3” in “Input Signal”→“Auto Pic.Mode Select”→“HDR10”. (“Auto Pic.Mode Select”P. 67)
- Configuring “Theater Optimizer” to “On” enables “HDR Quantizer” to be configured automatically according to the screen size and state of the projector. (“Theater Optimizer”P. 62)

Using the “Theater Optimizer”

1 Press the [MENU] button to display the menu, followed by selecting “Installation” → “Screen Setting” to display the “Screen Setting” menu.

- You can also display the menu by selecting “Screen Setting” from the “Theater Optimizer” menu.

2 Select “Screen Size(Diagonal)” to configure the size of the screen in use.

- This configures the size of the screen for viewing when using “Theater Optimizer”. However, to project an image with an aspect ratio other than 2.35:1 on a 2.35:1 screen, configure the size of the projected image.

Example on configuring the screen size

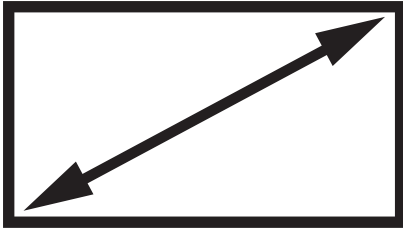

(a) To project a 16:9 image on a 16:9 screen
Configure the size of the screen.

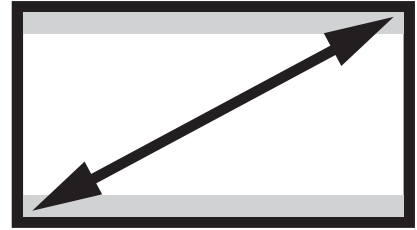

(b) To project a 2.35:1 image on a 16:9 screen
Configure the size of the screen.

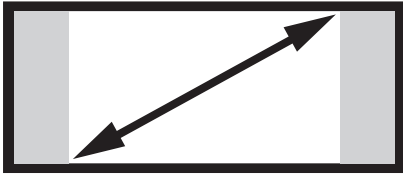

(c) To project a 16:9 image on a 2.35:1 screen
Configure the size of the projected image.

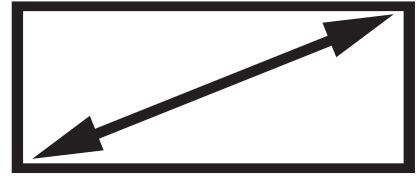

(d) To project a 2.35:1 image on a 2.35:1 screen
Configure the size of the screen.

-
- 3 Select “Screen Aspect” to configure the aspect ratio of the screen in use.
 - 4 Select “Screen Gain” to configure the gain of the screen in use.
 - 5 Configure “Picture Mode” to “Frame Adapt HDR 1”~“Frame Adapt HDR 3” (“Setting the Picture Mode”P. 32)
 - 6 Select “Picture Adjust” → “Theater Optimizer” to display the “Theater Optimizer” menu.
 - You can also display the menu by selecting “Theater Optimizer” from the “Screen Setting” menu.
 - * This can be configured only when “Picture Mode” is configured to “Frame Adapt HDR 1”~“Frame Adapt HDR 3”.
 - 7 Set “Theater Optimizer” to “On”
 - 8 Press “Set”.

The details of the screen is applied to the “Theater Optimizer” adjustment.

CAUTION

To use “Theater Optimizer”, configure the details of the screen in use in “Screen Setting”, followed by pressing “Set”. Pressing “Set” in the “Theater Optimizer” menu automatically applies the “Screen Setting” settings and state of the projector in the auto settings of “Theater Optimizer”. If “Set” is not pressed in the “Theater Optimizer” menu, the settings are applied after the next restart of the unit or change of the “Installation Mode”.

Adjusting Tone Mapping Automatically (Per Movie or Title)

- 1 Press the [MENU] button to display the menu, and set “Content Type” to “Auto” or “HDR10” in the “Picture Adjust” menu.
- 2 Configure “Picture Mode” to “HDR10” or “User 4 to User 6” in the “Picture Adjust” menu.
 - Alternatively, press the [PICTURE MODE] button and use the ↑↓ keys to configure a setting. (P. 32)
 - Enter the HDR10 content when “Content Type” is configured to “Auto”.
- 3 Press “Tone Mapping” in the “Picture Adjust” menu to display the Tone Mapping menu, followed by configuring “Tone Mapping” to “HDR(Auto)”. Alternatively, configure “Tone Mapping” to “Custom 1 to Custom 3”, followed by configuring “Correction Value” to “HDR(Auto)”.
- 4 Configure to “Mapping Level” in the “Picture Adjust” menu. *
 - * This may not appear depending on the settings. Please refer to “Mapping Level”P. 64 for details.

MEMO

When “Correction Value” is configured to “HDR(Auto)” while “Tone Mapping” is configured to “HDR(Auto)” or “Tone Mapping” configured to “Custom 1 to Custom 3”, “Picture Tone”“Dark Level”“Bright Level” may also be adjusted but the changes will not be saved.

To fine-tune the settings, configure “Tone Mapping” to “HDR(PQ)” and set manually.

➔ “Performing Tone Mapping Manually” (P. 44)

Performing Tone Mapping Manually

“HDR(PQ)” gamma is the PQ curve adopted by HDR10. Fine adjustments can be made according to the screen size and environment although the default settings for viewing with the projector have been adjusted to allow optimum viewing.

Default settings when viewing HDR content of this projector

Picture Mode : HDR10
Tone Mapping : HDR(PQ)
Estimated Screen Size : 90 to 120 inch (screen gain 1.0)
Estimated MaxCLL/MaxFALL : MaxCLL 1000 nits, MaxFALL 400 nits

Picture tone adjustment method



When Picture Tone is set to “-”
(The entire screen becomes dark.)

- Screen size is smaller than estimated
- MaxFALL/MaxCLL value is higher than estimated (P. 83)
- Screen becomes brighter in the course of viewing



When Picture Tone is set to “+”
(The entire screen becomes brighter.)

- Screen size is bigger than estimated
- MaxFALL/MaxCLL value is lower than estimated (P. 83)
- Screen becomes darker in the course of viewing

Bright/dark area adjustment method



(-) To enhance the contrast



(+) To make the dark area information more visible



(-) To enhance the gradation of highlight areas



(+) To enhance the contrast

 For users seeking to obtain a gamma curve that is more faithful to the original PQ curve

This unit has been adjusted to display the projector images on the screen in the optimal quality in the default setting based on the original PQ curve. For users who wish to obtain results more faithful to the original PQ curve, please adjust manually with reference to the values below.

When clipping point is 400 nits

Picture Tone	+5
Dark Level	0
Bright Level	+7

When clipping point is 1000 nits

Picture Tone	-7
Dark Level	0
Bright Level	+7

When clipping point is 2000 nits

Picture Tone	-9
Dark Level	0
Bright Level	+7

When clipping point is 4000 nits

Picture Tone	-13
Dark Level	0
Bright Level	+7

* This product is designed for home use and we do not provide guarantee for commercial uses such as in mastering work.

Fine-tuning the Image Quality

Adjusting the Output Value of the Projected Image (Gamma/Tone Mapping)

You can adjust the output value of the projected image with respect to the video signal input.

* This feature is not available when "Picture Mode" is configured to "Frame Adapt HDR 1"~"Frame Adapt HDR 3"/"HDR10+"/"FILMMAKER MODE".

Example of gamma adjustment

The overall image appear brighter with respect to the original image, making the dark areas more visible.

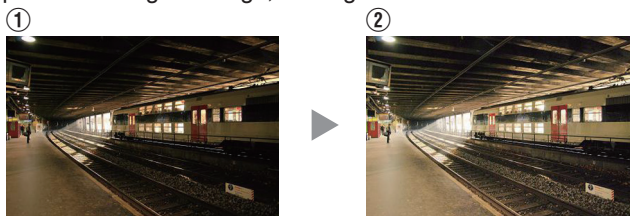
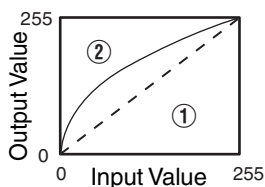

The photos are for illustrative purposes only.

Increases the contrast with respect to the original image, creating a greater sense of depth.

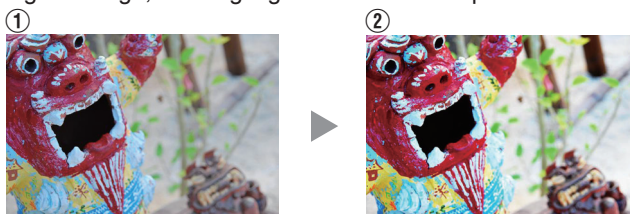
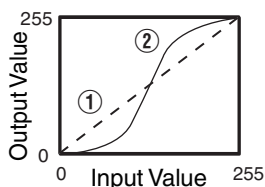

The photos are for illustrative purposes only.

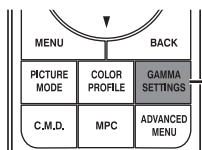

1 Press the [GAMMA SETTINGS] button to display the Gamma/Tone Mapping menu

2 Select the "Gamma/Tone Mapping" to configure

- You can also perform the setting by pressing the [MENU] button to display the menu followed by selecting "Picture Adjust" → "Gamma/Tone Mapping".
- The selectable "Gamma/Tone Mapping" settings vary according to "Picture Mode".

“Gamma/Tone Mapping” Settings

Gamma/Tone Mapping		Description
When “Color Profile” is set to “Film 1”	Film 1	Image is close to the characteristics of Eastman Kodak Company movie films.
	Film 2	Places more emphasis on the gradation compared to the “Film 1” setting.
When “Color Profile” is set to “Film 2”	Film 1	Places more emphasis on the contrast compared to the “Film 2” setting.
	Film 2	Image is close to the characteristics of FUJIFILM Corporation movie films.
2.2		The gamma is set to “2.2”, “2.4” and “2.6” respectively.
2.4		
2.6		
Cinema 1		Places emphasis on the gradation.
Cinema 2		Places emphasis on the contrast.
Vivid		Gamma settings that is suited for viewing when “Picture Mode” is configured to “Vivid”.
HDR(Auto)		Automatically corrects “Picture Tone”“Dark Level”“Bright Level” from Max CLL/Max FALL with “HDR(PQ)” as the base.
HDR(PQ)		Suited for viewing HDR content such as UHD BD (HDR10).
HDR(HLG)		Suited for viewing HDR content such as HDR broadcast.
Custom 1 to Custom 3		Enables fine adjustment of gamma according to preference.

List of Selectable “Gamma/Tone Mapping” According to “Picture Mode”

Picture Mode	Gamma/Tone Mapping
Film	Film 1
	Film 2
	Custom 1 to Custom 3
Vivid	Vivid, Custom 1 to Custom 3
Cinema Natural User 1 to User 3	2.2
	2.4
	2.6
	Cinema 1
	Cinema 2
	Custom 1 to Custom 3
HDR10	HDR(Auto)
	HDR(PQ)
	Custom 1 to Custom 3
HLG	HDR(HLG)
	Custom 1 to Custom 3
User 4 to User 6	HDR(Auto)
	HDR(PQ)
	HDR(HLG)
	Custom 1 to Custom 3

* The “Gamma/Tone Mapping” features are not available when “Picture Mode” is configured to “Frame Adapt HDR 1”~“Frame Adapt HDR 3”/“HDR10+”/“FILMMAKER MODE”

Fine-tuning of Gamma/Tone Mapping to Preferred Settings

You can perform fine adjustments based on the selected gamma adjustment setting.

1 Press the [GAMMA SETTINGS] button to display the Gamma/Tone Mapping menu

- You can also perform setting from “Picture Adjust”→Gamma/Tone Mapping in the menu.

2 Adjust to the preferred setting

- Select the color to be adjusted from “Color Selection” and adjust the “Picture Tone”, “Dark Level” and “Bright Level”.

Adjustment item and its setting

Item	Description	Setting
Color Selection	For selecting the color for adjusting “Picture Tone”, “Dark Level” and “Bright Level”.	White / Red / Green / Blue
Picture Tone	Adjusts the overall brightness automatically for a well-balanced result without compromising the gradation of the image.	-16 (darkens image for an underexposed effect) to +16 (brightens image for an overexposed effect)
Dark Level	Adjusts the dark areas of the input image. <ul style="list-style-type: none">• To do so, use the ◀▶ keys to move the cursor.	-7 (darkens the shadows) to +7 (brightens the shadows)
Bright Level	Adjusts the bright areas of the input image. <ul style="list-style-type: none">• To do so, use the ◀▶ keys to move the cursor.	-7 (darkens the highlights) to +7 (brightens the highlights)

Selecting the Base Correction Value (Initial Value) for Adjustment

- Selecting one of the “Custom 1” to “Custom 3” settings in “Gamma” allows you to select the “Correction Value”.
- Select the base “Correction Value” for adjustment using the ◀▶ keys.
- The selectable correction values vary according to “Picture Mode”. (Refer to the table below.)

List of selectable “Correction Value” according to “Picture Mode”

Picture Mode	Correction Value
Film	Film 1
	Film 2
	Import
Vivid	Vivid, Import
Cinema Natural User 1 to User 3	1.8
	1.9
	2.0
	2.1
	2.2
	2.3
	2.4
	2.5
	2.6
	Cinema 1
	Cinema 2
	Import

Picture Mode	Correction Value
HDR10	HDR(PQ)
	Import
HLG	HDR(HLG)
	Import
User 4 to User 6	HDR(PQ)
	HDR(HLG)
	Import

When “Correction Value” is set to “Import”

- By selecting “Import” for “Correction Value”, the gamma data created externally can be selected as the base setting value for adjustment.
- The factory setting for “Import” is “2.2”.
- You can use the calibration software to customize the gamma data adjustment, and import the created gamma data.

Please check with your authorized dealer for details.

Gamma Adjustment

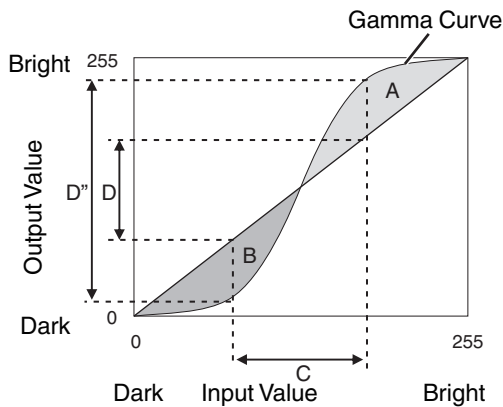

- When the gamma curve is a straight line:
The brightness and contrast of the video input will be the same as that of the video output.
- Area for which the gamma curve is above the straight line (A):
Video output appears brighter than the input.
- Area for which the gamma curve is below the straight line (B):
Video output appears darker than the input.
- Area for which the slope of the gamma curve is steep (midtone) (C):
The grayscale range of the video output becomes wider, and the contrast increases (D→D').

Reducing the Delay and After-image of Fast-moving Images (Motion Control)

Low Latency

For changing the low latency setting.
You are recommended to set to "On" for content requiring short latency such as games.

- 1 Press the [MENU] button to display the menu and select "Picture Adjust"→"Motion Control"→"Low Latency"

Setting	Description
Off	Does not perform the low latency setting.
On	Performs the low latency setting.

- * "Low Latency" cannot be configured when "Picture Mode" is configured to "HDR10+"/"Frame Adapt HDR 1"~"Frame Adapt HDR 3".
- * "Low Latency" cannot be configured when "Content Type" is configured to "HDR10" and "Picture Mode" is configured to "FILMMAKER MODE".
- * "Low Latency" cannot be configured when "Dynamic CTRL" is configured to a setting other than "Off".
- * "Clear Motion Drive" cannot be set when "Low Latency" is set to "On".
- * Even when "Low Latency" is set to "On", delay will not become zero.

Clear Motion Drive (C.M.D.)

Optimal interpolation according to the content is made possible with the new high-definition image interpolation technique.

For some scenes, interpolation may cause distortion in the image. In this case, set to "Off".

Original Image

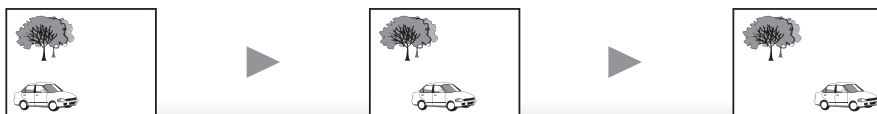

Interpolation Enabled

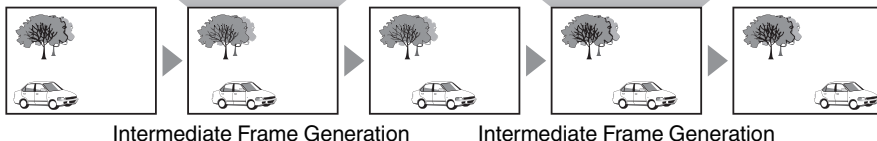

Intermediate Frame Generation

Intermediate Frame Generation

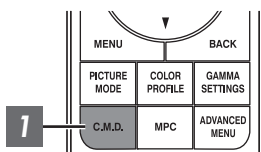

1 Press the [C.M.D.] button, use the [▲▼] keys to select a setting, followed by pressing [OK]

- You can also perform the setting by pressing the [MENU] button to display the menu followed by selecting "Picture Adjust"→"Motion Control"→"Clear Motion Drive".

Setting	Description
Off	Interpolation is not performed.
Low	Improves motion lag for movie type images.
High	Improves motion lag fast moving sports type images.
Inverse Telecine	60i/60p video images such as those of TVs and DVDs. Suitable for original images that are 24-frame film sources. <ul style="list-style-type: none"> Does not function for 24p video images.

* C.M.D. is the abbreviation for Clear Motion Drive.

* This item cannot be set when "Low Latency" is set to "On".

* This item cannot be set when "Picture Mode" is set to "FILMMAKER MODE".

* This item cannot be configured when the input signal is 100Hz/120Hz.

Motion Enhance

You can reduce motion blur with this function enhancing the response of D-ILA image devices.

If the image outline is unnatural, set this item to "Off".

1 Press the [MENU] button to display the menu and select "Picture Adjust"→"Motion Control"→"Motion Enhance"

Setting	Description
Off	Does not perform correction.
Low	Decreases jitter for fast moving video.
High	Further reduces image blurring than "Low".

Adjustments and Settings in the Menu

Pressing the [MENU] button displays the menu.

Press the [▲▼◀▶] keys to select an item, followed by pressing the [OK] button to confirm the selection.

List of Menu Items

Picture Adjust

▶Content Type	P. 56
▶Picture Mode	P. 32
▶More Settings	P. 56
↳ LD Power	P. 56
↳ Dynamic CTRL	P. 57
↳ Aperture	P. 57
↳ Contrast	P. 58
↳ Brightness	P. 58
↳ Color	P. 58
↳ Tint	P. 58
↳ User Name Edit	P. 58
▶Color Profile	P. 34
↳ Color Management	P. 37
↳ Color Selection	P. 59
↳ Hue	P. 59
↳ Saturation	P. 59
↳ Brightness	P. 59
▶Color Temp.	P. 59
↳ Correction Value	P. 61
↳ Gain Red / Gain Green / Gain Blue	P. 61
↳ Offset Red / Offset Green / Offset Blue	P. 61
▶Gamma/Tone Mapping	P. 46
↳ Correction Value	P. 62
↳ Picture Tone	P. 49
↳ Dark Level / Bright Level	P. 49
▶Theater Optimizer	P. 62
▶HDR Settings	P. 63
↳ HDR Processing	P. 63
↳ HDR Quantizer	P. 63
↳ Deep Black	P. 64
▶Mapping Level	P. 64
▶MPC/e-shift	P. 65
↳ 8K e-shift	P. 65
↳ Graphic Mode	P. 65
↳ Enhance	P. 65
↳ NR	P. 65
↳ BNR	P. 65
↳ MNR	P. 65
▶Motion Control	P. 51
↳ Low Latency	P. 51
↳ Clear Motion Drive	P. 52
↳ Motion Enhance	P. 52

Input Signal

▶Input Level	P. 66
▶Color Space	P. 66
▶3D Setting	P. 30
▶Auto Pic.Mode Select	P. 67
↳ SDR(2D)/ SDR(3D)	P. 67
↳ HDR10	P. 67
↳ HLG	P. 67
▶HDMI EDID Setting	P. 68
↳ Mode	P. 68
↳ DSC	P. 68
↳ HDR10+	P. 68
▶FILMMAKER MODE	P. 68

Installation

▶Installation Mode	P. 69
↳ Mode Select	P. 69
↳ Name Edit	P. 69
↳ Mode Copy	P. 69
▶Lens Control	P. 28
↳ Focus / Zoom / Shift	P. 70
↳ Image Pattern	P. 70
↳ Lock	P. 70
↳ Lens Center	P. 70
▶Pixel Adjust	P. 71
↳ Adjust	P. 71
↳ Adjust Area	P. 71
↳ Adjust Color	P. 71
↳ Adjust Pattern	P. 71
↳ Adjust Pattern Color	P. 71
↳ Adjust (Pixel)	P. 71
↳ Adjust (Fine)	P. 71
↳ Reset	P. 71
▶Mask	P. 75
↳ "Top" / "Bottom" / "Left" / "Right"	P. 75
▶Anamorphic	P. 75
▶Screen Setting	P. 76
↳ Screen Adjust	P. 76
↳ Screen No.	P. 76
↳ Screen Size	P. 76
↳ Screen Aspect	P. 76
↳ Screen Gain	P. 76
▶Installation Style	P. 77
▶Keystone	P. 77
▶Aspect	P. 29

Display Setup

▶Back Color	P. 77
▶Menu Position	P. 77
▶Signal Display	P. 77
▶Logo	P. 78
▶Language	P. 78

Function

▶Trigger	P. 78
▶Off Timer	P. 78
▶ECO Mode	P. 78
▶Network	P. 79
↳ Network Password	P. 79
▶Remote Code	P. 80
▶High Altitude Mode	P. 81
▶Hide Mode	P. 81
▶Back-up Settings	P. 81
↳ Export Settings	P. 81
↳ Import Settings	P. 81
▶Factory Reset	P. 82
▶Software Update	P. 82
▶License	P. 82

Information

▶Information	P. 83
--------------------	-------



Picture Adjust

Content Type

Changes the available picture modes according to the type of content for viewing.

- ➔ “Setting the Picture Mode” (P. 32)

Picture Mode

You can adjust the image quality according to the type of video image you are viewing.

- ➔ “Setting the Picture Mode” (P. 32)

More Settings

Changes the preconfigured “Picture Mode” setting.

LD Power

Controls the brightness of the light source by controlling the LD current.

- Setting range: 0 to 100

Dynamic CTRL

Expands the dynamic range of video expression through controlling the brightness of the light source based on image analysis.

➔ “Reducing the Delay and After-image of Fast-moving Images (Motion Control)” (P. 51)

Setting	Description
Off	Does not control.
Low	Maintains the peak brightness while automatically optimizing laser light source control and video signal. Weaker control than “High”.
High	Maintains the peak brightness while automatically optimizing laser light source control and video signal to produce a solid black tone throughout the entire video image.
Balanced	Adjusts both the shadows and highlights moderately while suppressing the peak brightness. Enhances the depth and reality of the scene.

* This item is not available when “Low Latency” is set to “On”.

Aperture

For changing the brightness through controlling the aperture.

- Setting range: -15 (stops down) to 0 (opens up)

Contrast

For adjusting the white level point to avoid clipping or over saturation.

- Setting range: -50 (little difference in brightness) to +50 (large difference in brightness)

Brightness

For adjusting the black level point to avoid clipping or over saturation.

- Setting range: -50 (darker) to +50 (brighter)

Color

For adjusting the color saturation of the video image.

- Setting range: -50 (lighter) to +50 (deeper)

Tint

For adjusting the hue of the video image.

- Setting range: -50 (reddish) to +50 (greenish)

User Name Edit

You can edit the “User 1” to “User 6” names in the Picture mode.

- Characters that are usable include alphabets (upper or lower case), numeric characters, symbols and blank (space) character. (However, blank (space) cannot be used for the first and last characters.)
- Enter not more than 10 characters.

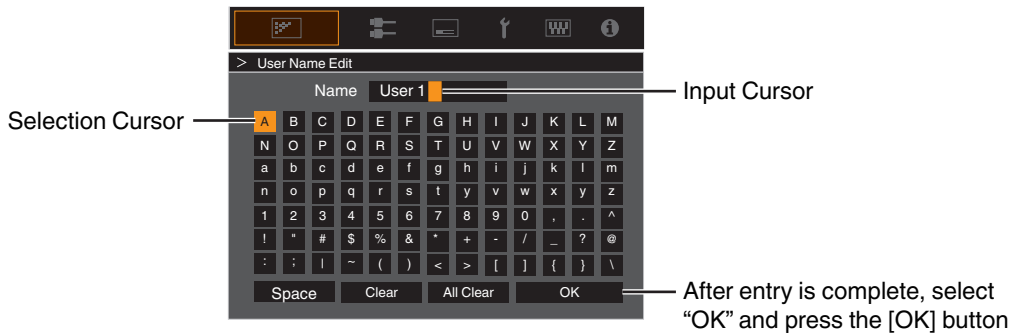

Color Profile

Configures the “Color Profile” (color space information) according to the preconfigured “Picture Mode”. It is also used to fine-tune the preconfigured “Color Profile” settings.

➔ “Setting the Color Profile” (P. 34)

- The available “Color Profile” settings vary according to “Picture Mode”.

Color Management, Color Selection, Hue, Saturation, Brightness

Each of the colors is adjustable according to the user’s preference.

➔ “Adjusting to your Preferred Color (Color Management)” (P. 37)

Color Temp.

Configures “Color Temp.” according to the preconfigured “Picture Mode”. It is also used to fine-tune the preconfigured “Color Temp.” settings.

- The “Color Temp.” settings available for configuration vary according to “Picture Mode”.
 - * When “Color Profile” is set to “Off (Wide)/Off (Normal)”, the setting is fixed at “High Bright”.

“Color Temp.”

Color Temp.	Description
Xenon 1	Color temperature that reproduces the characteristics of a xenon lamp used in cinemas. <ul style="list-style-type: none">• Xenon 1: A light source color that is emitted by a film projector• Xenon 2: A light source color emitted by a projector used for digital cinema
Xenon 2	
5500K	Increasing the value enhances the blue tone of the video image, while decreasing the value enhances the red tone.
6500K	
7500K	
9300K	
High Bright	Color temperature that gives priority to brightness.
HDR10+	Color temperature suitable for viewing HDR10+ content.
HDR10	Color temperature suitable for viewing HDR10 content. The default setting is 6500K.
HLG	Color temperature suitable for viewing HLG content. The default setting is 6500K.
Custom 1 to Custom 2	The color temperature of video images can be adjusted manually and saved as one of the three customized settings.

List of selectable “Color Temp.” according to “Picture Mode”

Picture Mode	Color Temp.
Film	Xenon 1
	Xenon 2
	Custom 1 to Custom 2
Cinema	5500K
	6500K
	7500K
	9300K
	Xenon 1
	Xenon 2
	High Bright
	Custom 1 to Custom 2
Natural Vivid User 1 to User 3	5500K
	6500K
	7500K
	9300K
	High Bright
	Custom 1 to Custom 2
HDR10+	HDR10+*
FILMMAKER MODE	6500K
Frame Adapt HDR 1 to Frame Adapt HDR 3 HDR10	5500K
	6500K
	7500K
	9300K
	High Bright
	HDR10
Custom 1 to Custom 2	
HLG	5500K
	6500K
	7500K
	9300K
	High Bright
	HLG
	Custom 1 to Custom 2

(Continue on next page)

Adjust/Set

Picture Mode	Color Temp.
User 4 to User 6	5500K
	6500K
	7500K
	9300K
	High Bright
	HDR10
	HLG
	Custom 1 to Custom 2

* When "Picture Mode" is set to "HDR10+", the setting is fixed at "HDR10+".

Correction Value

Configures the color temperature based on which "Gain Red" / "Gain Green" / "Gain Blue" / "Offset Red" / "Offset Green" / "Offset Blue" are adjusted when "Color Temp." is configured to "HDR10" "HLG" "Custom 1" "Custom 2".

- The "Correction Value" settings available for configuration vary according to "Picture Mode".

Gain Red / Gain Green / Gain Blue

Adjusts each color in the bright parts of the video image.

- Setting range: -255 (reduces the red/green/blue tone) to 0 (no adjustment)

Offset Red / Offset Green / Offset Blue

Adjusts each color in the dark areas of the video image.

- Setting range: -50 (reduces the red/green/blue tone) to 0 (no adjustment) to +50 (enhances the red/green/blue tone)

List of selectable "Correction Value" according to "Picture Mode"

Picture Mode	Correction Value
Film	Xenon 1
	Xenon 2
Cinema	5500K
	6500K
	7500K
	9300K
	Xenon 1
	Xenon 2
	High Bright
Natural Vivid Frame Adapt HDR 1 to Frame Adapt HDR 3 HDR10 HLG User 1 to User 3 User 4 to User 6	5500K
	6500K
	7500K
	9300K
	High Bright

Gamma/Tone Mapping

This item adjusts “Gamma/Tone Mapping” according to the preconfigured “Picture Mode” (output value of the projected video with respect to the video signal input). It is also used to adjust the preconfigured “Gamma/Tone Mapping” setting.

- ➔ “Adjusting the Output Value of the Projected Image (Gamma/Tone Mapping)” (P. 46)
- The available “Gamma/Tone Mapping” settings vary according to the “Picture Mode”.
 - *1 When “Picture Mode” is set to “HDR10+”, the setting is fixed at “HDR(Auto)”.
 - *2 “Gamma/Tone Mapping” cannot be configured when “Picture Mode” is configured to “Frame Adapt HDR 1”~“Frame Adapt HDR 3”.

Correction Value

For setting the base gamma for the adjustment of “Picture Tone”, “Dark Level” and “Bright Level” when one of the “Custom 1” to “Custom 3” settings is selected in Gamma/Tone Mapping.

- ➔ “Fine-tuning of Gamma/Tone Mapping to Preferred Settings” (P. 49)

Color Selection

For selecting the color for adjusting “Picture Tone”, “Dark Level” and “Bright Level”.

- ➔ “Fine-tuning of Gamma/Tone Mapping to Preferred Settings” (P. 49)

Picture Tone

Adjusts the overall brightness automatically for a well-balanced result without compromising the gradation of the image.

- ➔ “Fine-tuning of Gamma/Tone Mapping to Preferred Settings” (P. 49)
- ➔ “Performing Tone Mapping Manually” (P. 44)

Dark Level / Bright Level

You can adjust the image quality to produce a sharp contrast in the brightness.

- ➔ “Fine-tuning of Gamma/Tone Mapping to Preferred Settings” (P. 49)
- ➔ “Performing Tone Mapping Manually” (P. 44)

Theater Optimizer

This feature automatically configures the overall brightness level during tone mapping according to the screen size and state of the projector.

- ➔ “Using the “Theater Optimizer”” (P. 41)

To use, configure the details of the screen in use in “Screen Setting”, followed by pressing “Set”.

- *1 This option does not appear in the menu when “Content Type” is configured to “SDR”.
- *2 This can be configured only when “Picture Mode” is configured to “Frame Adapt HDR 1”~“Frame Adapt HDR 3”.

MEMO

Besides displaying the “Screen Setting” menu using “Installation”→“Screen Setting”, you can also press the “Screen Setting” button in the “Theater Optimizer” menu to display it.

CAUTION

Pressing “Set” in the “Theater Optimizer” menu automatically applies the details of the screen and state of the projector in the auto settings of “Theater Optimizer”.

If “Set” is not pressed in the “Theater Optimizer” menu, the settings are applied after the next restart of the unit or change of the “Installation Mode”.

HDR Settings

For configuring the picture adjustment feature of the HDR video image.

- *1 This item is not available when “Content Type” is set to “SDR”.
- *2 This feature is not available when the “Picture mode” is configured to “HDR10”, “HLG”, or “User 4” to “User 6”.

HDR Processing

This is a feature for configuring the content analysis method using “Tone Mapping” when “Picture Mode” is configured to “Frame Adapt HDR 1”~“Frame Adapt HDR 3” or “FILMMAKER MODE”.

- * When “Picture Mode” is configured to “HDR10+”, “HDR Processing” is fixed at “HDR10+”. “HDR10+” is used only when the Picture Mode is configured to “HDR10+”.

Setting	Description
Frame by Frame	Automatically adjusts the HDR tone mapping after analyzing the peak brightness of each frame.
Scene by Scene	Automatically adjusts the HDR tone mapping after analyzing the peak brightness of each scene.
Static	Configures based on the mastering information (MaxCLL/FALL) of the content and does not make any dynamic adjustment.
HDR10+	Automatically adjusts the brightness for each scene based on the HDR10+ image information. *2

HDR Quantizer

This is a feature for adjusting the overall brightness during tone mapping. For configuring the auto correction intensity of the “Theater Optimizer” feature when “Theater Optimizer” is configured to “On”.

When “Picture Mode” is configured to “Frame Adapt HDR 1”~“Frame Adapt HDR 3”, and “Theater Optimizer” is configured to “Off”, or when “Picture Mode” is configured to “FILMMAKER MODE”

Setting	Description
Auto (Normal)	Automatically selects an appropriate tone mapping based on the mastering information (MaxCLL/DML) of the content.
Auto (Wide)	Automatically selects an appropriate tone mapping based on the mastering information (MaxCLL/DML) of the content. A comparison is made with “Auto (Normal)” to switch to the direction that will become brighter.
-2	Displays in a tone map with 600 nits as the clip point.
-1	Displays in a tone map with 400 nits as the clip point.
0	Displays in a tone map with 300 nits as the clip point.
1	Displays in a tone map with 200 nits as the clip point.
2	Displays in a tone map with 150 nits as the clip point.

When “Picture Mode” is configured to “Frame Adapt HDR 1”~“Frame Adapt HDR 3”, and “Theater Optimizer” is configured to “On”

Setting	Description
Auto (Normal)	Automatically corrects the overall brightness level based on the mastering information (MaxCLL/DML) of the content.
Auto (Wide)	Automatically corrects the overall brightness level based on the mastering information (MaxCLL/DML) of the content. A comparison is made with “Auto (Normal)” to switch to the direction that will become brighter.
-2 to 2	For configuring the overall brightness level during auto correction. -2 (dark) to 2 (bright)

When “Picture Mode” is set to “HDR10+”

Setting	Description
High	Displays the tone map when the overall brightness is configured to the high level. This is suited for large-sized screens.
Mid	Displays the tone map when the overall brightness is configured to the medium level. This is suited for medium-sized screens.
Low	Displays the tone map when the overall brightness is configured to the low level. This is suited for small-sized screens.

To enjoy HDR10+ content when the Picture Mode is “HDR10+”, the following installation conditions are recommended.

	HDR Quantizer: High		HDR Quantizer: Mid		HDR Quantizer: Low	
	Screen Size Diagonal (inch)	Projection Distance (m)	Screen Size Diagonal (inch)	Projection Distance (m)	Screen Size Diagonal (inch)	Projection Distance (m)
NZ900 RS4200	115	3.64	97	3.12	89	2.66
NZ800 RS3200	107	3.49	92	3.00	80	2.62

	HDR Quantizer: High		HDR Quantizer: Mid		HDR Quantizer: Low	
	Screen Size Diagonal (inch)	Projection Distance (inch)	Screen Size Diagonal (inch)	Projection Distance (inch)	Screen Size Diagonal (inch)	Projection Distance (inch)
NZ900 RS4200	115	143	97	123	89	105
NZ800 RS3200	107	137	92	118	80	103

Deep Black

When “Picture Mode” is configured to a setting between “Frame Adapt HDR 1” and “Frame Adapt HDR 3” or “FILMMAKER MODE”, the tonal range of the shadows is controlled precisely to enhance the overall contrast of the image.

Setting	Description
On	Turns on the Deep Black feature for a more realistic expression of darkness.
Off	Turns on the Deep Black feature.

Mapping Level

For configuring the base brightness during auto correction when Gamma/Tone Mapping is configured to “HDR(Auto)”.

- The auto correction feature of “HDR(Auto)” is configured based on a 100" screen with a gain of 1.0 in total darkness.
- Adjust it in the positive direction if there is insufficient brightness in the viewing environment, and in the negative direction if it is too bright.
- *1 This option does not appear in the menu when “Content Type” is configured to “SDR”.
- *2 This option does not appear in the menu when “Picture Mode” is configured to “Frame Adapt HDR 1”~“Frame Adapt HDR 3”/“HDR10+”/“FILMMAKER MODE”.
- *3 When “Picture Mode” is configured to “HLG”, “Mapping Level” is fixed at “0”.
- *4 When “Picture Mode” is configured to “HDR10”/“User 4 to User 6”, this option is enabled only when “Tone Mapping” is configured to “HDR(Auto)”.
- Setting range: -5 to 5

MPC/e-shift

This is a feature for adjusting the sharpness of the displayed image. It employs an original algorithm to create a natural impression that is sharper at areas in focus and softer at areas that are not in focus, enabling you to enjoy highly expressive images with a greater sense of depth.

- *1 “Enhance” “NR” “BNR” “MNR” cannot be configured when “Picture Mode” is configured to “HDR10+”.
- *2 “Graphic Mode” “Enhance” “NR” “BNR” “MNR” cannot be configured when “Picture Mode” is configured to “FILMMAKER MODE”.

8K e-shift

For switching the e-shift display.

Setting	Description
On	Enables e-shift for display in 8K resolution
Off	Disables e-shift and displays in 4K resolution

Graphic Mode

Switches the MPC setting.

It is recommended that this item be configured to “Standard” such as when viewing normal Blu-ray content, and to “High-res 1” such as when viewing 8K/4K resolution content, and to “High-res 2” such as when inputting PC signals.

Setting	Description
Standard	Performs enhancement that is suited for input signals with a resolution of 4K or lower (particularly videos and animation)
High-res 1	Performs enhancement that is suited for input signals with a resolution of 8K/4K (particularly cinemas and films)
High-res 2	Video image with minimal enhancement.

Enhance

For adjusting the high-frequency areas. Increasing the value enhances the definition for a sharper image quality.

- Setting range: 0 to 10

NR

For reducing the noise of the video image.

- Setting range: 0 (weak) to 10 (strong)

BNR

For reducing the block noise of the video image.

- Setting range: 0 (weak) to 3 (strong)

MNR

For reducing the mosquito noise of the video image.

- Setting range: 0 (weak) to 3 (strong)

Toggling between the States before and during Adjustment

Pressing the [HIDE] button on the remote control enables you to toggle between the states before adjustment and during adjustment.

Motion Control

For reducing the after-image, which occurs in a fast-moving scene.

Low Latency

Clear Motion Drive

Motion Enhance

- ➔ “Reducing the Delay and After-image of Fast-moving Images (Motion Control)” (P. 51)



Input Signal

Input Level

For setting the dynamic range (gradation) of the video input.

If the image is not displayed properly even after selecting “Auto”, select an appropriate setting.

- If the dynamic range is not appropriate, the bright areas become overexposed, and the dark areas become underexposed.

Setting	Description
Auto	Sets the input signal level automatically.
16-235 (Video)	Select this setting if you are inputting video signals (dynamic range: 16 - 235).
0-255 (PC)	Select this setting if you are inputting PC signals (dynamic range: 0 - 255).
16-255 (S.White)	Select this setting when inputting Super White-compatible device signals (dynamic range: 16 - 255).

Color Space

For setting the color space of the input signal.

If the image is not displayed properly even after selecting “Auto”, select an appropriate setting.

Setting	Description
Auto	Detects “YCbCr444”, “YCbCr422”, and “RGB” automatically.
YCbCr444	Select this setting when inputting YCbCr (4:4:4) video signals.
YCbCr422	Select this setting when inputting YCbCr (4:2:2) video signals.
RGB	Select this setting when inputting RGB video signals.

3D Setting

For setting 3D movies for viewing.

- ➔ “Viewing 3D Movies” (P. 30)

Auto Pic.Mode Select

For configuring "Picture Mode" when the video type switches automatically while "Content Type" is configured to "Auto".

SDR(2D)/SDR(3D)

For configuring the "Picture Mode" to switch to automatically during input of SDR (2D) or SDR (3D) signal.

Setting	Description
Last Setting	Switches to the "Picture Mode" that was last configured when viewing SDR (2D) or SDR (3D) content.
Natural	Switches the "Picture Mode" automatically to "Natural".
Cinema	Switches the "Picture Mode" automatically to "Cinema".
Film	Switches the "Picture Mode" automatically to "Film".
Vivid	Switches the "Picture Mode" automatically to "Vivid".
User 1 to User 3	Switches the "Picture Mode" automatically to "User 1" to "User 3".

HDR10

For configuring the "Picture Mode" to switch to automatically during input of HDR10 signal.

Setting	Description
Last Setting	Switches to the "Picture Mode" that was last configured when viewing HDR10 content.
Frame Adapt HDR 1 to Frame Adapt HDR 3	Switches the "Picture Mode" automatically to "Frame Adapt HDR 1" to "Frame Adapt HDR 3".
HDR10	Switches the "Picture Mode" automatically to "HDR10".
User 4 to User 6	Switches the "Picture Mode" automatically to "User 4" to "User 6".

HLG

For configuring the "Picture Mode" to switch to automatically during input of HLG signal.

Setting	Description
Last Setting	Switches to the "Picture Mode" that was last configured when viewing HLG content.
HLG	Switches the "Picture Mode" automatically to "HLG".
User 4 to User 6	Switches the "Picture Mode" automatically to "User 4" to "User 6".

MEMO

- The "Auto Pic.Mode Select" settings are saved separately for each input terminal. The name of the currently selected input terminal is shown at the top right corner of the "Auto Pic.Mode Select" menu.
- To switch to configure the settings for a different input terminal, press the "INPUT" button on the remote control unit, or press the ↑↓ key on the projector unit after turning off the menu screen.

HDMI EDID Setting

Mode

For changing the EDID mode of the “HDMI 1/HDMI 2” terminal. Set to “A” under normal condition. The images may not be displayed on some old devices. In this case, try “B” or “C”.

Setting	Description
A	Configures the EDID mode to “A” Supports up to 8K60p NZ900 NZ800 and 4K120p.
B	Configures the EDID mode to “B” Supports up to 4K60p.
C	Configures the EDID mode to “C” Supports up to 1080p60.

* EDID (Extended Display Identification Data) refers to the information, such as supported resolutions, exchanged between devices.

DSC

For configuring whether DSC transmission is allowed. Set to “On” under normal condition.

Setting	Description
On	Allows compressed video transmission
Off	Prohibits compressed video transmission

* DSC (Digital Stream Compression) is a lossless signal compression standard used mostly by PC type sources. It allows true 8K signals to be transmitted at a lower bandwidth capability and improve system stability.

HDR10+

For configuring whether HDR10+ transmission is allowed. To enjoy HDR10+ content, configure to “On”.

Setting	Description
On	Allows HDR10+ transmission
Off	Prohibits HDR10+ transmission

MEMO

- The “HDMI EDID Setting” settings are saved separately for each input terminal. The name of the currently selected input terminal is shown at the top right corner of the “HDMI EDID Setting” menu.
- To switch to configure the settings for a different input terminal, press the “INPUT” button on the remote control unit, or press the ↑↓ key on the projector unit after turning off the menu screen.

FILMMAKER MODE

For configuring whether to switch “Picture Mode” automatically to “FILMMAKER MODE” when FILMMAKER MODE is detected.

Setting	Description
Auto	Automatically switches “Picture Mode” to “FILMMAKER MODE” when FILMMAKER MODE is detected.
Manual	Does not automatically switch “Picture Mode” to “FILMMAKER MODE” when FILMMAKER MODE is detected.

MEMO

- Displays a message asking whether to switch “Picture Mode” automatically when FILMMAKER MODE is detected for the first time. If “No” is selected, “FILMMAKER MODE” will be configured to “Manual”. To enable automatic switching, configure “FILMMAKER MODE” to “Auto”.



Installation

Installation Mode

Collectively manages the setting values of “Lens Control”, “Pixel Adjust”, “Mask”, “Anamorphic”, “Screen Setting”, “Installation Style”, “Keystone” and “Aspect”.

- * The lens position may be shifted slightly with respect to the position that was saved.

Mode Select

For selecting the group to save and retrieve the setting values.

- Setting values: Mode 1 to Mode 10
- * The name of the setting value can be changed using “Name Edit”.

Name Edit

For editing the name of Installation Mode.

- Characters that are usable include alphabets (upper or lower case), numeric characters, symbols and blank (space) character. (However, blank (space) cannot be used for the first and last characters.)
- Enter not more than 10 characters.



Mode Copy

For copying the setting values managed by the current Installation Mode to another mode.

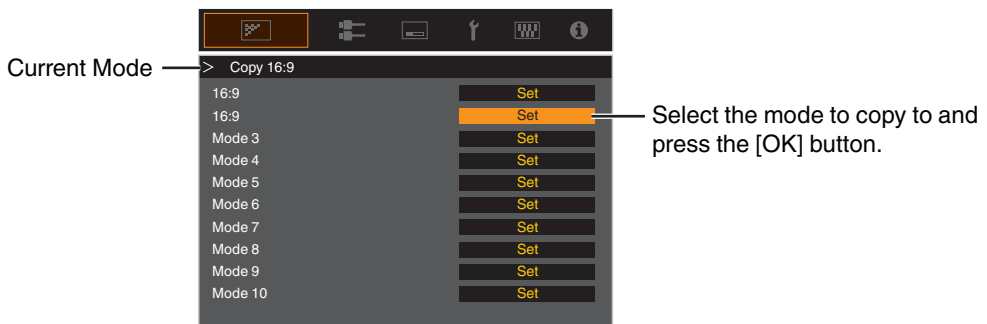

Lens Control

Focus / Zoom / Shift

For adjusting the lens according to the projection position

- ➔ “Adjusting the Lens According to the Projection Position” (P. 28)

Image Pattern

For setting whether to display the lens adjustment pattern.

Setting	Description
Off	Displays external signals, and does not display the lens adjustment pattern.
On	Displays the lens adjustment pattern.

Lock

For setting whether to lock or unlock the lens.

Setting to “On” to lock the lens allows you to preserve the adjustment status of the lens.

Setting	Description
Off	Does not lock the lens.
On	Locks the lens to prevent any erroneous operation on the adjustments. <ul style="list-style-type: none">• Even when “On”, the lens will be in the mode selected by “Installation Mode”.

Lens Center

Returns the lens position to the center.

Pixel Adjust

For correcting the phase shifting between each RGB color by adjusting the pixel.

Adjust

For setting the adjustment feature to On or Off.

Adjust Area

Setting	Description
Whole	Adjusts the entire image.
Zone	Enables fine adjustment of each area by dividing the screen evenly into 10 vertical and horizontal zones.

Adjust Color

For selecting the color to adjust (“Red” or “Blue”).

Adjust Pattern

Setting	Description
Off	Displays the external signals without displaying the test pattern for adjustment.
On	Displays the test pattern for adjustment.

Adjust Pattern Color

For setting the color of the adjustment pattern displayed during adjustment to “White” or “Yellow / Cyan”.

Adjust (Pixel)

When “Adjust Area” is set to “Whole”, adjustment can be made by moving in units of one pixel on the screen of the color selected in “Adjust Color”.

- ➔ “Whole Adjust (Pixel) Operation Procedure” (P. 72)
- Adjustment cannot be made when “Adjust Area” is set to “Zone”.

Setting	Description
H (Horizontal)	Setting range: -2 (moves red/blue to the left) to +2 (moves red/blue to the right)
V (Vertical)	Setting range: -2 (moves red/blue downward) to +2 (moves red/blue upward)

Adjust (Fine)

When “Adjust Area” is set to “Whole”, adjustment can be made by moving in units of 1/8 pixel on the screen of the color selected in “Adjust Color”.

- ➔ “Whole Adjust (Fine) Operation Procedure” (P. 73)

When “Adjust Area” is set to “Zone”, the screen is divided evenly into 10 vertical and horizontal zones, and fine adjustment of each area is possible.

- ➔ “Zone Adjust Operation Procedure” (P. 74)

Setting	Description
H (Horizontal)	Setting range: -31 (moves red/blue to the left) to +31 (moves red/blue to the right)
V (Vertical)	Setting range: -31 (moves red/blue downward) to +31 (moves red/blue upward)

Reset

Restores all pixel adjustment data to the factory default.

Whole Adjust (Pixel) Operation Procedure

For making general adjustments to slight color fringing in the horizontal/vertical directions of the video image.

- ① Set “Adjust Area” to “Whole”
- ② Select “Adjust Color” and “Adjust Pattern Color”
- ③ Select “Adjust (Pixel)”, and press the [OK] button
 - The Adjustment mode is activated, and the selected adjustment pattern and Adjustment (Pixel) window are displayed.

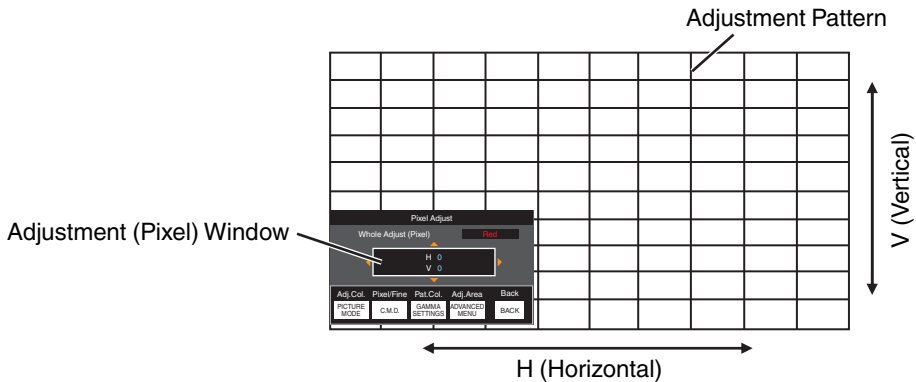

- ④ Use the [▲▼◀▶] keys to move and adjust the vertical and horizontal pixels of the entire zone

- The adjustment setting appears at the center of the Adjustment (Pixel) window.

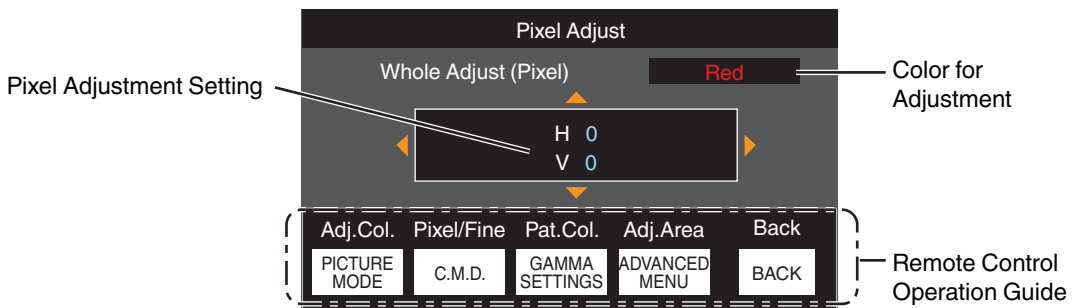

- ⑤ After adjustment is complete, press the [BACK] button twice to exit the Adjustment mode

Remote Control Operation Guide

Button Name	Function	Description of Operation
[PICTURE MODE]	Adj.Col.	Changes “Adjust Color”.
[C.M.D.]	Pixel/Fine	Switches between “Adjust (Pixel)” and “Adjust (Fine)”. • Switches to “Adjust (Pixel)” when “Adjust Area” is set to “Zone”.
[GAMMA SETTINGS]	Pat.Col.	Changes “Adjust Pattern Color”.
[ADVANCED MENU]	Adj.Area	Switches “Adjust Area”. • A zone cursor appears on the adjustment pattern when the “Zone” setting is selected.

Whole Adjust (Fine) Operation Procedure

For making general adjustments on the misalignment of the entire screen using “Adjust (Pixel)”, followed by making fine adjustments.

- ① Set “Adjust Area” to “Whole”
- ② Select “Adjust Color” and “Adjust Pattern Color”
- ③ Select Adjust (Fine), and press the [OK] button
 - The Adjustment mode is activated, and the selected adjustment pattern and Fine window are displayed.
 - The adjustable range may be smaller depending on the pixels being adjusted on the entire screen.

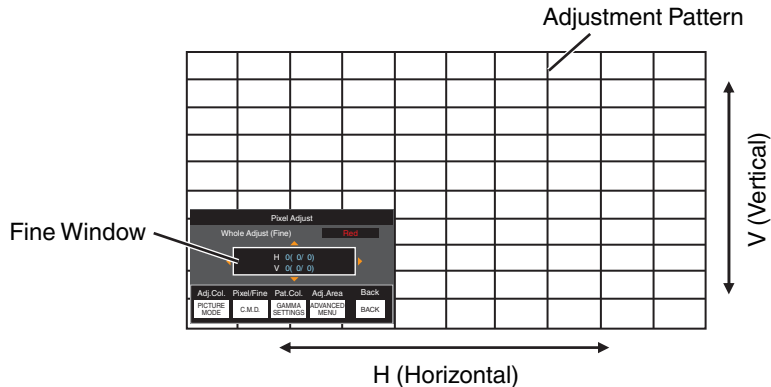

- ④ Use the [▲▼◀▶] keys to move and adjust the vertical and horizontal pixels of the entire zone
 - The adjustment setting appears at the center of the Fine window.

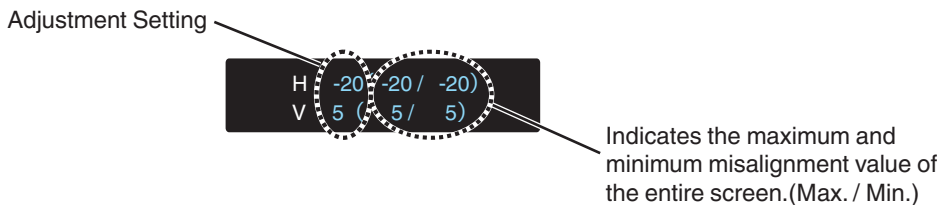
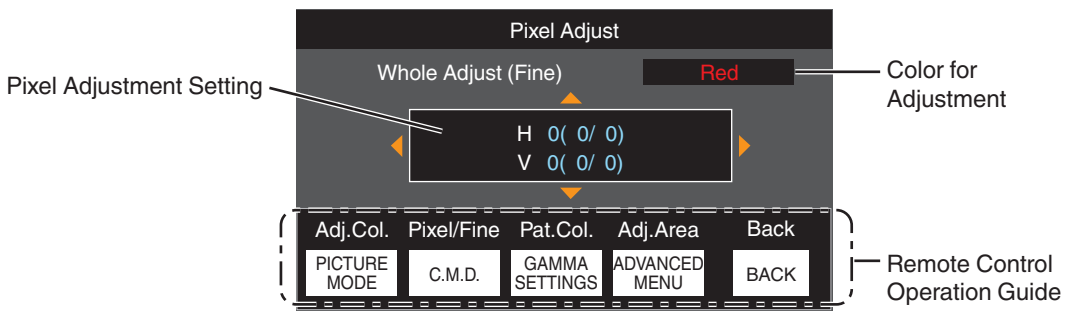

- ⑤ After adjustment is complete, press the [BACK] button twice to exit the Adjustment mode

MEMO

- If both the maximum overall screen misalignment of H (horizontal direction) and V (vertical direction) are “31”, you cannot select a value that is larger than the displayed setting even when the adjustment setting is lower than the maximum value.
- If the minimum overall screen misalignment is “-31”, you cannot select a value that is smaller than the displayed setting even when the adjustment setting is higher than the minimum value.

Zone Adjust Operation Procedure

For fine-tuning misalignments on a part of the screen after adjusting the overall screen misalignment using “Adjust (Pixel)” and “Adjust (Fine)”.

- The screen can be divided vertically and horizontally into 10 sections for partial adjustments to be made.
- ① Set “Adjust Area” to “Zone”
 - ② Select “Adjust Color” and “Adjust Pattern Color”
 - ③ Select Adjust (Fine), and press the [OK] button
 - The Adjustment mode is activated, and the selected adjustment pattern and Zone Adjustment window are displayed.
 - The adjustable range may be smaller depending on the pixels being adjusted on the entire screen.

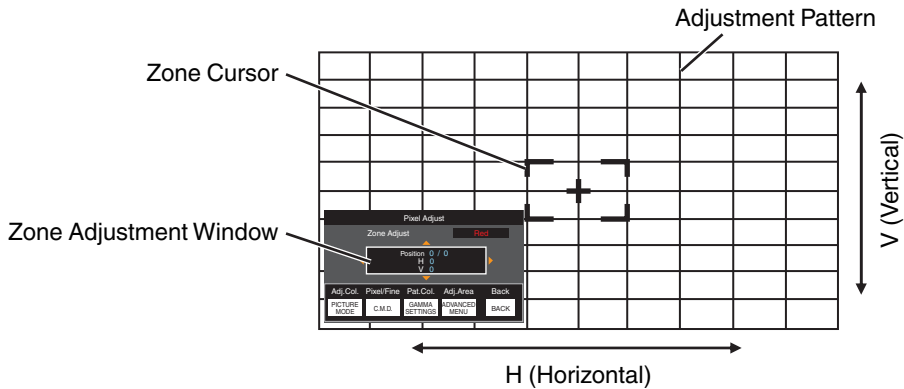

- ④ Press the [▲▼◀▶] keys to move the cursor to the point to be adjusted
- ⑤ Press the [OK] button to enter the Adjustment mode
- ⑥ Use the [▲▼◀▶] keys to move and adjust the vertical and horizontal pixels of the entire zone
 - The adjustment setting appears at the center of the Zone Adjustment window.

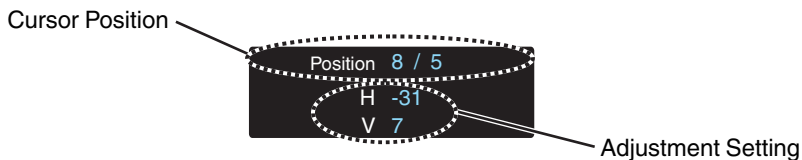
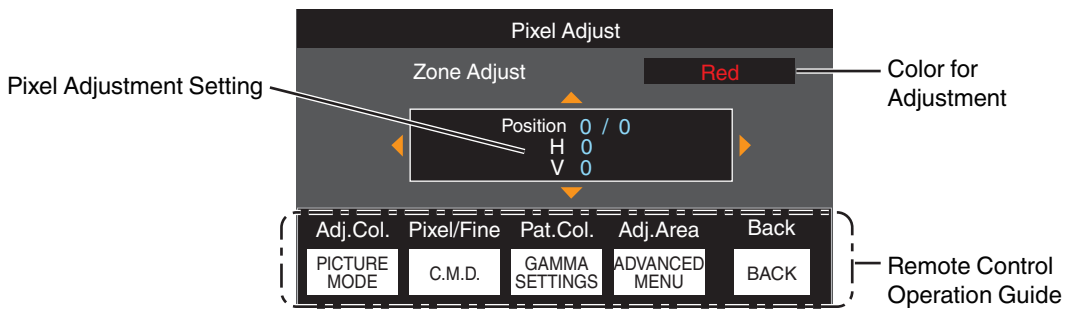

- ⑦ After adjustment is complete, press the [BACK] button twice to exit the Adjustment mode

Mask

For hiding the peripheral area of the image with a mask (black strip).

Setting	Description
Off	Not masked.
On	Hides the ranges specified in “Top”, “Bottom”, “Left” and “Right” by masking (with black strips).

■ Off



■ On



Mask: black strip around the periphery

“Top” / “Bottom” / “Left” / “Right”

For specifying the ranges to hide by masking (with black strips).

- Setting range: 0 to 220

Anamorphic

Configure this setting when an anamorphic lens is used.

Setting	Description
Off	Projects the 2.35:1 image without any changes.
A	Projects the 2.35:1 image with it stretched in the vertical direction only using a 3840 pixel width.
B	Projects the 16:9 image with it compressed in the horizontal direction only.
C	This is a mode used exclusively for the DCR lens of Panamorph. Projects the image by stretching 2.35:1 video images in the vertical direction and enlarging them in the horizontal direction to the maximum panel width of 4096 pixels. This is configured to “A” in the 3D mode.
D	This is a mode used exclusively for the DCR lens of Panamorph. Projects the 16:9 image with it compressed in the horizontal direction only.

Screen Setting

Screen Adjust

Corrects the color temperature according to the properties of the screen to be used.

Selecting the optimal correction mode enables corrections to be performed to reproduce natural images with balanced colors.

- This feature is not available when “Color Profile” is configured to “Off (Wide)” or “Off (Normal)”.

Setting	Description
Off	Does not perform correction
On	Corrects the color temperature according to the properties of the screen configured in “Screen No.”.

Screen No.

For configuring the correction mode according to the screen to be used.

- This item cannot be set when “Screen Adjust” is set to “Off”.
- For information on the screen and the corresponding correction mode, please visit our website.

<https://www.jvc.com/global/projector/screen>

MEMO

- You can utilize the optional optical sensor and dedicated projector calibration software to make finer adjustments. For details on the dedicated projector calibration software, please visit our website.

<http://www3.jvckenwood.com/english/download/>

Screen Size(Diagonal)

For configuring the size (diagonal) of the screen for viewing when using the “Theater Optimizer” function.

Screen Aspect

For configuring the aspect ratio of the screen for viewing when using the “Theater Optimizer” function.

Screen Gain

For configuring the gain of the screen for viewing when using “Theater Optimizer”.

MEMO

- Configuring “Theater Optimizer” to “On” enables the brightness level during “Tone Mapping” to be adjusted automatically according to the screen size and state of the projector when picture mode is configured to “Frame Adapt HDR 1”~“Frame Adapt HDR 3”.
 - The “Theater Optimizer” can be displayed by selecting “Theater Optimizer”. (This option is disabled when picture mode is configured to a mode other than “Frame Adapt HDR 1”~“Frame Adapt HDR 3”.)
- ➔ “Using the “Theater Optimizer”” (P. 41)

CAUTION

The “Screen Size”/“Screen Gain” settings will be applied to the auto settings of “Theater Optimizer” during the next restart of the unit or change of the “Installation Mode”.

To apply the settings immediately, press “Set” in the “Theater Optimizer” menu.

Installation Style

For setting to “Front”, “Ceiling Mount (F)”, “Rear”, or “Ceiling Mount (R)” according to the installation status of the projector.

- “Front” or “Ceiling Mount (F)” is set when projector is installed in the front with respect to the screen.
- “Rear” or “Ceiling Mount (R)” is set when projector is installed in the rear with respect to the screen.

Keystone

For correcting any keystone distortion that occurs when the projector is installed at an angle with respect to the screen. Vertical Keystone only.

- Vertical setting range: -7 to 7
- * Increasing the value changes the aspect slightly.
- * Image will reduce in size when keystone is adjusted.

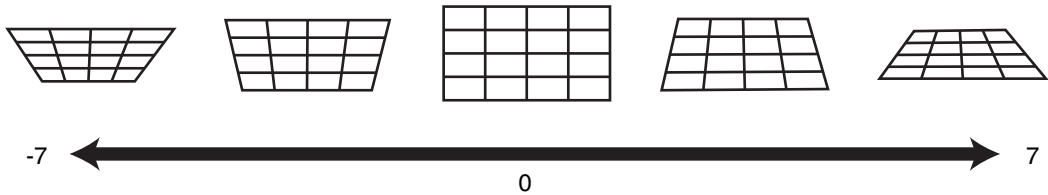

Aspect

The screen size of the projected image can be adjusted optimally according to the original screen size (aspect) that has been input.

- ➔ “Adjusting the Screen Size (Aspect)” (P. 29)

Display Setup

Back Color

For setting the color of the background to “Blue” or “Black” when there is no signal input.

Menu Position

For setting the display position of the menu.

Signal Display

For setting the display of the input information to “On” or “Off”.

Setting	Description
Off	Not displayed.
On	Shows the input terminal for 5 seconds when input is switched.

Logo

For setting the display of logo during startup to “On” or “Off”.

Setting	Description
Off	Not displayed.
On	Displays the “D-ILA” logo for 5 seconds during startup.

Language

For setting the display language to “English”, “Deutsch”, “Español”, “Italiano”, “Français”, “Português”, “Nederlands”, “Polski”, “Norsk”, “繁體中文”, or “日本語”.

Function

Trigger

For setting whether to supply a 12 V output to devices such as an external screen equipped with a trigger function.

Setting	Description
Off	No output.
Power	Outputs control signals (12 V) from the trigger terminal when the power is turned on.
Anamo	Outputs control signals when the “Anamorphic” setting is changed from “Off” to a setting other than “Off”. Outputs control signals when the projector is powered on if “Anamorphic” is configured to a setting other than “Off” when the power is turned on.
Inst. Mode 1 to Inst. Mode 10	Outputs control signals when the “Installation Mode” number to be retrieved is the same as the number configured. Outputs control signals when the projector is powered on if the “Installation mode” has the same number as this setting when the power is turned on.

* When a setting other than “Off” is selected, the control signal output is stopped when the cooling function starts once the power is turned off.

Off Timer

For setting the duration before the power turns off automatically when the projector is not operated.

• Setting values: “Off”, “1 Hour”, “2 Hours”, “3 Hours” and “4 Hours”

* The setting will be retained even after the Off Timer operation has completed.

ECO Mode

Setting	Description
On	Enables “ECO Mode” to minimize power consumption in the Standby mode. <ul style="list-style-type: none">• RS-232C / LAN communication cannot be used in the Standby mode.• If there is no signal transmission and operation for 15 minutes while an image is projected, the power management switches the equipment automatically into standby mode.
Off	Select this option to control via RS-232C / LAN communication in the Standby mode or if Control4 is to be used.

* If this unit enters into standby while “ECO Mode” is set to “On”, all the indicators on the unit including the “STANDBY/ON” indicator are turned off. To turn on the power from this state, use the [STANDBY/ON] button on the unit. Alternatively, press any button on the remote control once to cancel the standby mode then press the [ON] button on the remote control.

Network

For specifying the settings for external control from a PC or smartphone.

Setting		Description
DHCP Client	On	Obtains the IP address automatically from the DHCP server inside the connected network.
	Off	For configuring the network settings manually.
IP Address		For configuring the IP address.
Subnet Mask		For configuring the subnet mask.
Default Gateway		For configuring the default gateway.
MAC Address		Displays the MAC address of the unit.
Set		Applies the network settings.
Control4 SDDP		Set to "On" to allow Control4 SDDP to detect this unit. When this unit is not connected to an environment under the control of the controller and Control4 SDDP from the Control4 Corporation, set this to "Off".

Glossary of Network Terminology

- DHCP** : Abbreviation for Dynamic Host Configuration Protocol. This is a protocol for the network to assign an IP address automatically to the connected device.
- IP Address** : Numeric characters for identifying the device that is connected to the network.
- Subnet Mask** : Numeric characters that define the bit count used for the network address that is a segment of the IP address.
- Default Gateway** : Server for communicating beyond the network that is divided by the subnet mask.
- MAC Address** : Abbreviation for Media Access Control address. This is a number that is unique to each network adapter. Each of the network adapters is assigned with a unique MAC address.

Network Password

For configuring the password during LAN connection.

- Characters that are usable include alphabets (upper or lower case), numeric characters, and symbols.
- Enter a password with at least 8 characters and not more than 10 characters.



CAUTION

- Configuration of a network password is necessary before connecting to the LAN terminal.
- * Any 3rd party IP control system will have to configure this password into their communication protocol.

Remote Code

For changing the remote control code.

Setting	Description
A	Change the remote control code from "B" to "A".
B	Change the remote control code from "A" to "B".

- You need to configure the remote control according to the settings of this unit.
On the remote control unit, press the [MENU] button for three seconds or longer while pressing and hold the [BACK] button to switch the code.
 - The backlight of the remote control blinks 3 times: change the remote control code to "A"
 - The backlight of the remote control blinks 2 times: change the remote control code to "B"
- If the setting differs between this unit and the remote control, the "STANDBY/ON" indicator blinks in green when receiving the remote control code.

WARNING

LIGHT

STANDBY/ON
(Green)

High Altitude Mode

For setting the high altitude mode to “On” or “Off”.

Set to “On” when using the projector at a location of low atmospheric pressure (higher than 900 m (3,000 ft) above sea level).

Hide Mode

For reducing the power consumption through suppressing the current supply for the LD block when the [HIDE] button is pressed to hide the image temporarily.

Setting	Description
Off	The illumination supply remains on when the [HIDE] button is pressed to hide the image.
On	The illumination supply is turned off when the [HIDE] button is pressed to hide the image.

Back-up Settings

For exporting or importing the projector settings using a commercially available USB flash drive.

- Current lens control information (focus, zoom and shift) and the lens control information (focus, zoom and shift) saved in the individual Installation Modes are not exported or imported.
- Network passwords are not exported or imported.

CAUTION

Take note of the following when using a USB flash drive.

- Use a 1 GB or more, FAT32 format drive.
- Make sure there are no other folders or files.
- Do not turn off the main unit or remove the USB flash drive while it is running. Doing so may cause the projector to malfunction.
- Do not change the file name.

Export Settings

For exporting the projector settings to a USB flash drive.



- * If there is not enough free space on the USB flash drive, the settings may not be exported.
- * Information such as date and time created is not reflected in the file created during export.

CAUTION

- Multiple settings cannot be exported to the same USB flash drive. If the data already exists in the USB flash drive, it will be overwritten.

Import Settings

For exporting the projector settings from a USB flash drive and applying to the projector.

- * Once the settings have been imported, the projector and all LED indicators will turn off. To turn on the power again, use the  button on the unit. Alternatively, press any button on the remote control once to put it to Standby then press the  [ON] button on the remote control.

CAUTION

Importing the settings will overwrite the current settings.

Factory Reset

For restoring the settings of this unit to the factory default. However, the following settings will not be reset.

- Gamma data saved in “Gamma” → “Correction Value” → “Import”.
- Color profile data saved in “Color Profile” → “Custom1 to Custom4”.

Software Update

For performing a software update.

For the latest information on the software, refer to <https://www3.jvckenwood.com/english/download/>.

License

For displaying the license in use.

Information

Setting	Description
Input	Displays the currently selected video input terminal.
Source (Displayed only during video signal input)	Displays the input source.
Resolution (Displayed only during PC signal input)	Displays the image resolution.
H Frequency	Displays the horizontal frequency.
V Frequency	Displays the vertical frequency.
Color Space	Displays the color space and color bit depth of the input video signal. <ul style="list-style-type: none"> • The color bit depth is not displayed when “YCbCr422” is input. • The color bit depth is displayed when color bit depth information is received from the source device.
Colorimetry	Displays the Colorimetry of the input signal.
HDR	Displays the EOTF information when HDR packet is received. Displays “HDR10+” when HDR10+ packets are received. Displays “FILMMAKER MODE” when FILMMAKER MODE packets are received.
Max CLL/FALL/DML	Displays the mastering information of the content during HDR playback. Max CLL: Maximum Content Light Level Max FALL: Maximum Frame Average Light Level Max DML: Brightness of the master monitor during content production <ul style="list-style-type: none"> • The information may not be displayed depending on the player and content.
Light Source Time	Displays the laser light source time.
Soft Ver.	Displays the firmware version.

Maintaining the Cabinet and Remote Control

- Gently wipe off dirt on the cabinet with a soft cloth.
- If it is extremely dirty, wet a cloth in water, wring dry and use it to wipe off the dirt, followed by wiping again with a dry cloth.
- Pay attention to the following as the cabinet may deteriorate in condition or the paint may come off.
 - Do not wipe with thinner or benzine
 - Do not allow prolonged contact with rubber or plastic products
 - Do not spray volatile chemicals such as insecticide

Cleaning and Replacing the Filter

Clean the filter every 2000 hours (more often in dusty conditions). Using a filter without cleaning may reduce the brightness of the image. Dirt that enters the unit may also appear as shadows on the image.

Replacing the Filter

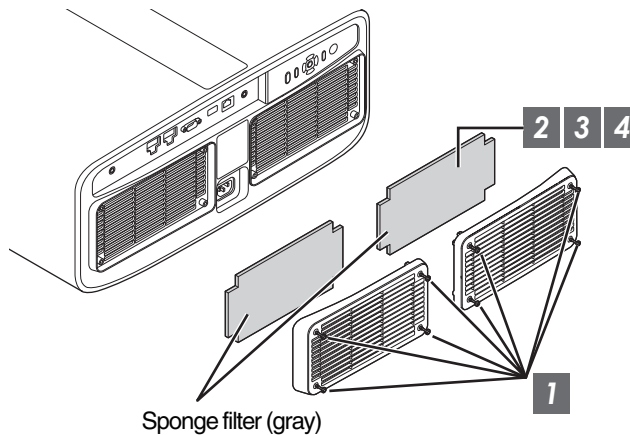

- 1** Loosen the screws at the four corners and remove the cover
 - The screws cannot be removed from the cover. Do not try to remove the screws from the cover by force.
- 2** Remove the sponge filter
- 3** Use a vacuum cleaner to remove dirt from the sponge filter carefully

Maintenance

4 Restore the sponge filter to the original position

Place the sponge filter under the tabs

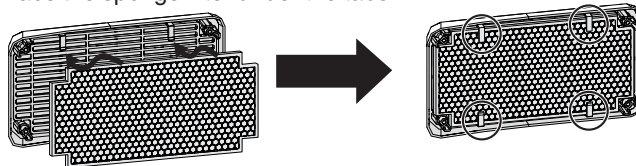

5 Restore the cover and fasten the screws at the four corners

MEMO

- If the sponge filter is damaged and requires replacement, or if dirt gets into the unit, consult your authorized dealer or nearby service center.
- Sponge spacer
Product no.: J3K-0134-00

Troubleshooting

Before sending the unit to your authorized dealer for repair, please check the following points.

The following symptoms are not malfunctions.

You do not need to worry about the following symptoms if there is no abnormality on the screen.

- A part of the top or front surface of the unit is hot.
- A creaking sound is heard from the unit.
- An operating sound is heard from the inside of the unit.
- Color smear occurs on some screens.

This unit is a digital device. This unit may become unable to operate normally due to external static or noise. Perform the following operations when such malfunctions occur.

- ① If the unit is in the Standby mode, pull out the power plug, followed by inserting it again
- ② Press the /I button on the projector unit to turn on the power again

When “High Altitude Mode” is set to “On” and this unit is set to 3D mode, the fan will make louder noise than usual since it is designed to run at high speed in 3D mode.

Power is not supplied

Check	Action	Refer to
Is the power cord disconnected?	Insert the power cord (plug) firmly.	P. 25
Is the unit in the Cool-down mode?	After exiting the Cool-down mode, turn on the power again.	P. 27
Is the unit in the Eco mode?	Press the  /I button on the projector unit or the remote control unit. After the “STANDBY/ON” indicator lights up in red, press the I [ON] button.	P. 78

Power shuts down automatically

Check	Action	Refer to
Has “ECO Mode” been configured?	Set “ECO Mode” to “Off”.	P. 78
Has “Off Timer” been configured?	Set “Off Timer” to “Off”.	P. 78
Are the air inlets and exhaust vent blocked?	Leave proper clearance when installing the unit.	P. 15, 20
Is there a large amount of dirt attached to the sponge filter?	Remove the dirt using a vacuum cleaner.	P. 84

Video image does not appear

Check	Action	Refer to
Is the correct external input selected?	Select the correct external input terminal.	P. 26
Is the power of the AV device or PC turned on?	Turn on the power of the AV device or PC and play the video.	P. 23
Is the AV device or PC properly connected?	Connect the AV device or PC properly.	P. 23
Are the correct signals being output from the AV device or PC?	Set the AV device or PC properly.	P. 23
Is the cable in use an HDMI-certified cable?	Use an Ultra High Speed HDMI Cable (supports 48 Gbps). HDMI cable may be directional and some HDMI cables require external power. Please check the specifications of the cable you are using.	P. 23
Is an intermediate device (AV amplifier, divider, etc.) in use?	Change the sequence of turning on the source device, intermediate device and the projector. And after turning on each device, ensure that the signal output is stable before turning on the next device. If the intermediate device does not support compressed video transmission, configure the DSC setting under "HDMI EDID Setting" to "Off". If the intermediate device does not support HDR10+, configure the HDR10+ setting under "HDMI EDID Setting" to "Off".	P. 68
Is an old source device in use?	Change the resolution setting of the source device. For details on how to change the setting, please refer to the instruction manual of the source device. Also, try the "B" "C" mode settings under "HDMI EDID Setting".	P. 68
Is the input signal 2K (2048x1080) 24/25/30/60Hz?	If the input signal is 2K (2048x1080) 24/25/30/50/60Hz, configure the "Mode" setting in "HDMI EDID Setting" to "B".	P. 68

3D images do not appear

Check	Action	Refer to
Do you see two images displayed side by side?	Set "3D Format" to "Side by Side" Video images in the "Side by Side" format may not be recognized automatically in the case of 3D video images.	P. 31
Is an intermediate device (AV amplifier, divider, etc.) in use?	Connect the source device to the projector directly, and check whether there is any improvement in the condition. If the condition improves, it is likely that this is not caused by malfunction of the projector.	P. 23
Is the cable in use an HDMI-certified cable?	Use an HDMI-certified high-speed cable. Also, use as short a cable as possible.	P. 23
Is the power of the 3D Glasses turned on?	If you are using the PK-AG3 3D Glasses, turn on the power manually.	Check the instruction manual of the 3D Glasses and 3D Synchro Emitter.
Are the 3D Glasses charged?	Check the PK-AG3 battery of the 3D Glasses is charged.	
Are the 3D Glasses and 3D Synchro Emitter too far away from each other?	Position them at an appropriate distance.	
Are the 3D Glasses synced?	Check the 3D Glasses are synced.	

3D video image looks unnatural

Check	Action	Refer to
Are there overlapping video images?	If there are overlapping video images partially, this is due to the crosstalk phenomenon. In this case, adjust “Crosstalk Cancel” accordingly.	P. 31
	If there are overlapping video images partially, this is due to the crosstalk phenomenon. It may be improved by increasing the value of “LD Power”.	P. 56

Video image looks unnatural

Colors are unnatural

Check	Action	Refer to
Is the color space of the input signal correctly set?	The color may turn out unnatural when the input signal is different from that in the projector setting. Set the “Color Space” for “Input Signal” correctly.	P. 66
Is the image correctly adjusted?	Adjust “Color” and “Tint” accordingly. Check Picture Settings.	P. 58
Is the AV device or PC properly connected?	Connect the AV device or PC properly.	P. 23

* The video image may appear slightly reddish immediately after starting up. This is not a malfunction.

Video image is fuzzy

Check	Action	Refer to
Is the focus correctly adjusted?	Adjust the focus.	P. 28
Is the unit placed too near or too far away from the screen?	Set the unit at a correct distance from the screen.	P. 98

Video image flickers

Check	Action	Refer to
Do you see horizontally-extended, overlapping video images?	In this case, set “3D Format” to “Auto”	P. 31
Are you viewing the video images under a fluorescent light?	This is caused by interference between the 3D glasses with the flickers of the fluorescent light. View with the fluorescent light turned off.	—
Has “Dynamic CTRL” been configured?	Set “Dynamic CTRL” to “Off”	P. 57

Video format changes

Check	Action	Refer to
Is the cable in use an HDMI-certified cable?	Depending on the quality of the cable in use, the signal from the device connected may change to a receivable video format. Make use of an HDMI cable with the Ultra High Speed HDMI Cable certification (supports 48 Gbps).	P. 23

Projected image is dark

Check	Action	Refer to
Is the aperture closed?	Increase the value of the "Aperture" setting.	P. 57
Is the "LD Power" value set too low?	Increase the "LD Power" value.	P. 56
Is "Theater Optimizer" set to "On"?	Press "Set" in the "Theater Optimizer" menu.	P. 41
Check Picture Settings.	Select different Picture Mode.	P. 32
Is "Dynamic CTRL" set to a setting other than "Off"?	Set "Dynamic CTRL" to "Off".	P. 57

Video image appears horizontally (vertically) extended

Check	Action	Refer to
Is "3D Format" set to "Side by Side"?	Set "3D Format" to "Auto"	P. 31
Is "Anamorphic" set to a setting other than "Off"?	Set "Anamorphic" to "Off"	P. 75

Moire patterns appear on the screen

Check	Action	Refer to
Does the fabric of the screen have a regular pattern?	Interference fringes may sometimes occur between the fabric pattern and the pixels. Please consult the authorized dealer.	—

Part of the video Image is missing

Check	Action	Refer to
Has screen mask been configured?	Set "Mask" to "Off".	P. 75
Is "Anamorphic" set to a setting other than "Off"?	Set "Anamorphic" to "Off".	P. 75
Is "Aspect" set to a setting other than "Native"?	Set "Aspect" to "Native"	P. 29

Remote control does not work

Check	Action	Refer to
Are the batteries correctly installed?	Match the polarities (\oplus \ominus) correctly when loading the batteries.	P. 18
Are the batteries exhausted?	Replace with new batteries.	P. 18
Is there an obstructing object between the remote control and remote sensor?	Remove any obstructing object.	P. 18
Is the remote control held too far away from the unit?	Hold the remote control closer to the sensor during use.	P. 18
Is remote control code correctly?	Match the settings of the projector and the remote control. The factory settings are both "A".	P. 80

Noise is heard

Check	Action	Refer to
Is the exhaust vent blocked? Is the unit used near a heater or air-conditioner?	Check the installation condition of the projector. When the surrounding temperature of the projector is high, the fan revolution speed increases to protect the projector unit, hence a louder operating sound.	P. 20
Is the "LD Power" value set too high?	Setting the "LD Power" value too high increases the fan rotation speed, and noise would be louder as a result.	P. 56
Is the "8K e-shift" setting for "MPC" switched?	Switching sound is generated. This is not a malfunction.	—

Unable to connect to LAN terminal

Check	Action	Refer to
Has a network password been configured?	Configuration of a network password is necessary before connecting to the LAN terminal. Configure the network password.	P. 79

There are small black or colored dots on the screen

The D-ILA device is manufactured using high-precision technologies, but there may be some (less than 0.01%) missing pixels or pixels that remain permanently lit. This is not a malfunction.

Settings are not exported

Check	Action	Refer to
Is there enough free space on the USB flash drive?	Take note of the following when using a USB flash drive. <ul style="list-style-type: none">• Use a 1 GB or more, FAT32 format drive.• Make sure there are no other folders or files.	P. 81

When the Following Messages Appear...

Message	Description	Action
No Input	<ul style="list-style-type: none">• No device is connected to the input terminal.• The input terminal is connected but there is no signal.	Input the video signals.
Out of Range	The video signal input is not supported on this unit.	Input video signals that can be used. (P. 106)

External Control

It is possible to control this unit by connecting it to a PC using an RS-232C cross cable (D-sub 9-pin). The projector can be controlled by connecting it to a PC through the computer network with a LAN cable for control commands to be sent to the projector.

➔ “Network” (P. 79)

- Please use it after you have gained proper understanding from professional books or consulting the system administrator.

RS-232C Specifications

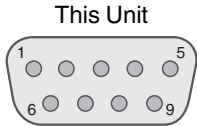

Pin No.	Signal	Function	Signal Direction
2	RxD	Receive data	PC → This unit
3	TxD	Transmission data	This unit → PC
5	GND	Signal ground	—
1, 4, 6 - 9	N/C	—	—

- PC refers to the controller, such as a personal computer.

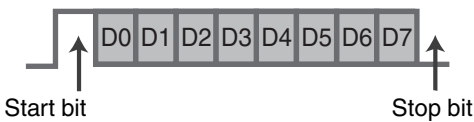

Mode	Non-synchronous
Character length	8 bit
Parity	None
Start bit	1
Stop bit	1
Data rate	19200 bps
Data format	Binary

TCP/IP Connection

Before controlling via LAN, it is necessary to establish connection of the TCP layer by a “3-way handshake”, followed by sending out “PJREQ” and receiving “PJACK” within five seconds after the projector sends out “PJ_OK” for connection authentication.

If you are unable to complete sending within five seconds, or when “PJ_NG” or “PJNAK” is received, check the operating status of the projector, followed by performing the steps again starting from establishment of a TCP connection.

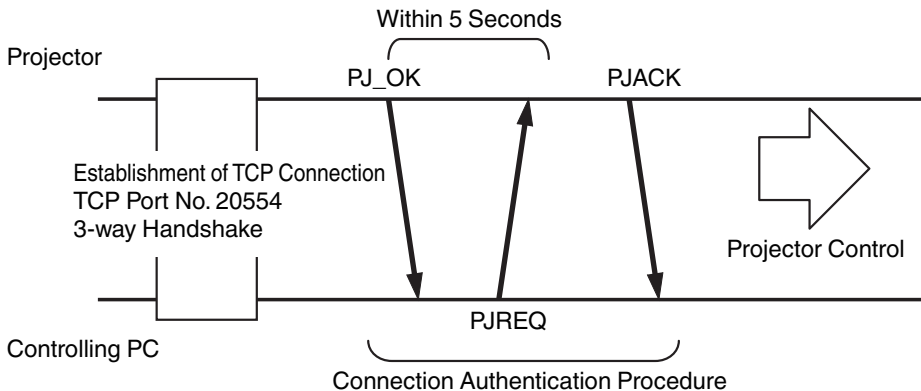

Command Format

The command between this unit and the computer consists of “Header”, “Unit ID”, “Command”, “Data” and “End”.

- Header (1 byte), Unit ID (2 bytes), Command (2 bytes), Data (n bytes), End (1 byte)

Header

This binary code indicates the start of communication.

Binary Code	Type	Description
21	Operating command	PC → This unit
3F	Reference command	PC → This unit
40	Response command	This unit → PC
06	ACK	This unit → PC (returns to PC after the command is accepted without error)

Unit ID

This is a code that specifies the unit. The binary code is fixed at “8901”.

Command and data

Operating command and data (binary code)

Command	Type	Description
0000	Connection check	Check whether communication is enabled between this unit and the PC during standby.
5057	Power supply	During standby 31: Turns on the power When power is on 30: Turns off the power (Standby mode)
4950	Input	When power is on 36: HDMI 1 37: HDMI 2
5243	Remote control	Sends the same code as the supplied remote control. <ul style="list-style-type: none">• “Remote Control Code”P. 94

Reference command and data (binary code)

Command	Type	Description
5057	Power supply	During standby or when power is on 30: Standby mode 31: When power is on 32: In the Cool-down mode 34: When error occurs on this unit
4950	Input	When power is on 36: HDMI 1 37: HDMI 2

End

This code indicates the end of communication. The binary code is fixed at “0A”.

Remote Control Code

Binary code is sent during communication.

Remote Control Button Name	Binary Code
STANDBY	37 33 30 36
ON	37 33 30 35
INPUT	37 33 30 38
SETTING MEMORY	37 33 44 34
LENS CONTROL	37 33 33 30
HIDE	37 33 31 44
INFO.	37 33 37 34
▲	37 33 30 31
▼	37 33 30 32
▶	37 33 33 34
◀	37 33 33 36

Remote Control Button Name	Binary Code
OK	37 33 32 46
MENU	37 33 32 45
BACK	37 33 30 33
PICTURE MODE	37 33 46 34
COLOR PROFILE	37 33 38 38
GAMMA SETTINGS	37 33 46 35
C.M.D.	37 33 38 41
MPC	37 33 46 30
ADVANCED MENU	37 33 37 33

Communications Example

This section shows the communication examples of RS-232C.

Operating command

Type	Command	Description
Connection check	PC → This unit: 21 89 01 00 00 0A This unit → PC: 06 89 01 00 00 0A	Connection check
Power (On)	PC → This unit: 21 89 01 50 57 31 0A This unit → PC: 06 89 01 50 57 0A	When power is turned on from the Standby mode
Power (Off)	PC → This unit: 21 89 01 50 57 30 0A This unit → PC: 06 89 01 50 57 0A	When power is turned off (Standby mode) from power-on mode
Remote control (MENU)	PC → This unit: 21 89 01 52 43 37 33 32 45 0A This unit → PC: 06 89 01 52 43 0A	When the same operation as pressing the [MENU] button on the remote control is performed

Reference command

Type	Command	Description
Power (On)	PC → This unit: 3F 89 01 50 57 0A This unit → PC: 06 89 01 50 57 0A This unit → PC: 40 89 01 50 57 31 0A	When information on the power-on state is acquired
Input (HDMI 1)	PC → This unit: 3F 89 01 49 50 0A This unit → PC: 06 89 01 49 50 0A This unit → PC: 40 89 01 49 50 36 0A	When information on HDMI 1 input is acquired

Specifications

Product Name	D-ILA Projector	
Model Name	DLA-NZ900BK, DLA-NZ900BE, DLA-NZ800BK, DLA-NZ800BE, DLA-RS4200K, DLA-RS4200E, DLA-RS3200K, DLA-RS3200E	
Display Panel/Size	D-ILA device *1, 2 0.69" 4K D-ILA (4096 x 2160 pixels) x 3	
Projection Lens	2.0 x power zoom lens, motorized zoom and focus	
Light Source	Laser Diode	
Screen Size	Approx. 60" to 280" (Aspect ratio of 16:9) NZ900 RS4200 Approx. 60" to 200" (Aspect ratio of 16:9) NZ800 RS3200	
Brightness	3300 lm NZ900 RS4200 , 2700 lm NZ800 RS3200	
Projection Distance	Refer to P. 98.	
Input Compatibility Signal	Refer to P. 106.	
Display Resolution	8192 x 4320 pixels (8K/e-shift)	
Input Terminal	HDMI Input	Dual, HDMI 19-pin x 2 (HDCP 2.3-compatible) *3
Output Terminal	Trigger Terminal	Single, Ø 3.5 mm DC Power Jack (⊖ ⊕) DC OUT 12 V, 0.1 A
	3D synchro	Dedicated terminal for 3D Synchro Emitter (single, mini-DIN 3-pin)
Control Terminal	RS-232C Terminal	Single, D-sub 9-pin (male) (external control)
	LAN Terminal	Single, RJ45 jack, 10BASE-T/100BASE-TX
	Service Terminal	SERVICE Single (USB Type A) *4
Power Requirements	AC 100 V to 240 V, 50 Hz/60 Hz	
Power Consumption	440 W (during normal standby: 1.5 W *5, during Eco Mode standby: 0.3 W)	
Operation Environment	Temperature: 5°C to 35°C; humidity: 20% to 80%; storage temperature: -10°C to 60°C	
Installation Altitude	Below 6,561 ft (2,000 m)	
Dimensions (Width x Height x Depth)	500 mm x 234 mm x 528 mm (19-3/4 in x 9-1/4 in x 20-13/16 in) (including feet) NZ900 RS4200 500 mm x 234 mm x 505 mm (19-3/4 in x 9-1/4 in x 19-15/16 in) (including feet) NZ800 RS3200	
Mass	25.3 kg (55.7 lb) NZ900 RS4200 , 23.1 kg (50.9 lb) NZ800 RS3200	
Accessories	Refer to P. 13.	

*1 D-ILA is the abbreviation for Direct Drive Image Light Amplifier.

*2 D-ILA devices are manufactured using extremely high-precision technology with a pixel effectiveness of 99.99%. Only 0.01% or less of the pixels are either missing or would remain permanently lit.

*3 HDCP is the abbreviation for High-bandwidth Digital Content Protection system. The image of the HDMI input terminal may not be displayed in some cases due to changes in the HDCP specifications.

*4 For software update and setting backup features.

*5 The power consumption of this product during networked standby when all wired network ports are connected is 1.5 W.

- Design and specifications are subject to change without prior notice.
- Please note that some of the pictures and illustrations may have been abridged, enlarged or contextualized in order to aid comprehension. Images may differ from the actual product.



This unit has acquired the certification of the “HDR10+” standard set by HDR10 + Technologies, LLC. Tone mapping is optimally performed for each scene according to the dynamic metadata to faithfully reproduce HDR video images for viewing according to the intentions of the video producer. HDR10+™ logo is a trademark of HDR10+ Technologies, LLC.



This unit is isf-certified, so calibration can be performed by an isf-certified trainer. After calibration is performed, an isf mode is added to the Picture mode. For more details, please refer to the isf website. <http://www.imagingscience.com/>

About Trademarks and Copyrights



The terms HDMI, HDMI High-Definition Multimedia Interface, HDMI Trade dress and the HDMI Logos are trademarks or registered trademarks of HDMI Licensing Administrator, Inc.



FILMMAKER MODE™ logo is a trademark of UHD Alliance, Inc.

FILMMAKER MODE™

Screen Size and Projection Distance

NZ900 R54200

Screen Size Diagonal (inch)	Projection Distance (m)									
	17:9 Screen		16:9 Screen		2.35:1 Screen		2.40:1 Screen		4:3 Screen	
	Wide-end	Tele-end	Wide-end	Tele-end	Wide-end	Tele-end	Wide-end	Tele-end	Wide-end	Tele-end
60	1.66	3.43	1.75	3.61	1.86	3.82	1.86	3.83	2.16	4.44
70	1.96	4.02	2.06	4.23	2.18	4.47	2.19	4.48	2.54	5.19
80	2.25	4.60	2.37	4.84	2.50	5.12	2.51	5.13	2.91	5.94
90	2.54	5.19	2.67	5.46	2.83	5.77	2.83	5.78	3.29	6.70
100	2.83	5.77	2.98	6.07	3.15	6.41	3.16	6.43	3.66	7.45
110	3.12	6.36	3.28	6.69	3.47	7.06	3.48	7.09	4.04	8.20
120	3.41	6.94	3.59	7.30	3.79	7.71	3.81	7.74	4.41	8.95
130	3.70	7.53	3.90	7.92	4.12	8.36	4.13	8.39	4.79	9.71
140	3.99	8.11	4.20	8.53	4.44	9.01	4.45	9.04	5.16	10.46
150	4.28	8.70	4.51	9.15	4.76	9.66	4.78	9.69	5.53	11.21
160	4.58	9.28	4.81	9.76	5.09	10.31	5.10	10.34	5.91	11.96
170	4.87	9.87	5.12	10.38	5.41	10.96	5.43	10.99	6.28	12.72
180	5.16	10.45	5.43	10.99	5.73	11.61	5.75	11.65	6.66	13.47
190	5.45	11.04	5.73	11.61	6.05	12.26	6.07	12.3	7.03	14.22
200	5.74	11.62	6.04	12.22	6.38	12.91	6.40	12.95	7.41	14.98
210	6.03	12.21	6.34	12.84	6.70	13.56	6.72	13.60	7.78	15.73
220	6.32	12.79	6.65	13.45	7.02	14.21	7.05	14.25	8.16	16.48
230	6.61	13.38	6.95	14.07	7.35	14.85	7.37	14.90	8.53	17.23
240	6.90	13.96	7.26	14.68	7.67	15.50	7.69	15.55	-	-
250	7.19	14.55	7.57	15.30	7.99	16.15	8.02	16.2	-	-
260	7.49	15.13	7.87	15.91	8.32	16.80	8.34	16.86	-	-
270	7.78	15.72	8.18	16.53	8.64	17.45	8.67	17.51	-	-
280	8.07	16.31	8.48	17.14	-	-	-	-	-	-
290	8.36	16.89	-	-	-	-	-	-	-	-
300	8.65	17.48	-	-	-	-	-	-	-	-

Screen Size Diagonal (inch)	Projection Distance (m)			
	16:9 image on a 2.35:1 aspect screen		16:9 image on a 2.40:1 aspect screen	
	Wide-end	Tele-end	Wide-end	Tele-end
60	-	-	-	-
70	-	-	-	-
80	1.87	3.85	1.84	3.78
90	2.12	4.34	2.08	4.26
100	2.36	4.83	2.32	4.75
110	2.61	5.32	2.56	5.23
120	2.85	5.82	2.80	5.71
130	3.09	6.31	3.04	6.19
140	3.34	6.80	3.28	6.68
150	3.58	7.29	3.52	7.16
160	3.83	7.78	3.76	7.64
170	4.07	8.27	4.00	8.12
180	4.32	8.76	4.24	8.61
190	4.56	9.25	4.48	9.09
200	4.81	9.75	4.72	9.57
210	5.05	10.24	4.96	10.05
220	5.29	10.73	5.20	10.54
230	5.54	11.22	5.44	11.02
240	5.78	11.71	5.68	11.50
250	6.03	12.20	5.92	11.98
260	6.27	12.69	6.16	12.47
270	6.52	13.18	6.40	12.95
280	6.76	13.67	6.64	13.43
290	7.00	14.17	6.88	13.91
300	7.25	14.66	7.12	14.40

* The values in the projection table may contain $\pm 5\%$ error. If the product is to be used at the Wide-end or the Tele-end, set a margin of about 5%.

Screen Size Diagonal (inch)	Projection Distance (inch)									
	17:9 Screen		16:9 Screen		2.35:1 Screen		2.40:1 Screen		4:3 Screen	
	Wide-end	Tele-end	Wide-end	Tele-end	Wide-end	Tele-end	Wide-end	Tele-end	Wide-end	Tele-end
60	65.5	135.1	69.1	142.2	73.1	150.3	73.3	150.8	85.2	174.7
70	77.0	158.2	81.1	166.4	85.8	175.8	86.1	176.4	100.0	204.3
80	88.5	181.2	93.1	190.6	98.5	201.4	98.8	202.1	114.7	234.0
90	99.9	204.2	105.2	214.8	111.2	227.0	111.6	227.7	129.5	263.6
100	111.4	227.3	117.2	239.0	123.9	252.5	124.3	253.3	144.2	293.2
110	122.8	250.3	129.3	263.3	136.7	278.1	137.1	279.0	158.9	322.9
120	134.3	273.4	141.3	287.5	149.4	303.7	149.9	304.6	173.7	352.5
130	145.8	296.4	153.4	311.7	162.1	329.2	162.6	330.3	188.4	382.1
140	157.2	319.4	165.4	335.9	174.8	354.8	175.4	355.9	203.2	411.8
150	168.7	342.5	177.5	360.1	187.5	380.3	188.1	381.6	217.9	441.4
160	180.1	365.5	189.5	384.3	200.2	405.9	200.9	407.2	232.6	471.0
170	191.6	388.5	201.5	408.5	212.9	431.5	213.6	432.8	247.4	500.7
180	203.1	411.6	213.6	432.8	225.7	457.0	226.4	458.5	262.1	530.3
190	214.5	434.6	225.6	457.0	238.4	482.6	239.1	484.1	276.8	559.9
200	226.0	457.6	237.7	481.2	251.1	508.2	251.9	509.8	291.6	589.6
210	237.4	480.7	249.7	505.4	263.8	533.7	264.7	535.4	306.3	619.2
220	248.9	503.7	261.8	529.6	276.5	559.3	277.4	561.1	321.1	648.8
230	260.3	526.8	273.8	553.8	289.2	584.8	290.2	586.7	335.8	678.5
240	271.8	549.8	285.9	578.0	302.0	610.4	302.9	612.3	-	-
250	283.3	572.8	297.9	602.2	314.7	636.0	315.7	638.0	-	-
260	294.7	595.9	309.9	626.5	327.4	661.5	328.4	663.6	-	-
270	306.2	618.9	322.0	650.7	340.1	687.1	341.2	689.3	-	-
280	317.6	641.9	334.0	674.9	-	-	-	-	-	-
290	329.1	665.0	-	-	-	-	-	-	-	-
300	340.6	688.0	-	-	-	-	-	-	-	-

Screen Size Diagonal (inch)	Projection Distance (inch)			
	16:9 image on a 2.35:1 aspect screen		16:9 image on a 2.40:1 aspect screen	
	Wide-end	Tele-end	Wide-end	Tele-end
60	-	-	-	-
70	-	-	-	-
80	73.7	151.6	72.4	148.9
90	83.4	171.0	81.8	167.9
100	93.0	190.3	91.3	186.9
110	102.6	209.6	100.7	205.9
120	112.2	229.0	110.2	224.9
130	121.8	248.3	119.6	243.9
140	131.5	267.6	129.1	262.9
150	141.1	287.0	138.5	281.8
160	150.7	306.3	148.0	300.8
170	160.3	325.7	157.4	319.8
180	169.9	345.0	166.9	338.8
190	179.6	364.3	176.3	357.8
200	189.2	383.7	185.8	376.8
210	198.8	403.0	195.2	395.8
220	208.4	422.3	204.7	414.8
230	218.0	441.7	214.1	433.8
240	227.6	461.0	223.6	452.8
250	237.3	480.4	233.0	471.8
260	246.9	499.7	242.5	490.8
270	256.5	519.0	251.9	509.8
280	266.1	538.4	261.4	528.8
290	275.7	557.7	270.8	547.8
300	285.4	577.1	280.3	566.8

* The values in the projection table may contain $\pm 5\%$ error. If the product is to be used at the Wide-end or the Tele-end, set a margin of about 5%.

Screen Size Diagonal (inch)	Projection Distance (m)									
	17:9 Screen		16:9 Screen		2.35:1 Screen		2.40:1 Screen		4:3 Screen	
	Wide End	Tele End	Wide End	Tele End	Wide End	Tele End	Wide End	Tele End	Wide End	Tele End
60	1.79	3.66	1.88	3.85	1.99	4.07	1.99	4.08	2.31	4.73
70	2.09	4.28	2.20	4.50	2.33	4.76	2.33	4.77	2.70	5.52
80	2.40	4.90	2.52	5.15	2.67	5.44	2.67	5.46	3.10	6.32
90	2.70	5.52	2.84	5.80	3.00	6.13	3.01	6.15	3.49	7.11
100	3.01	6.14	3.16	6.45	3.34	6.81	3.35	6.83	3.88	7.91
110	3.31	6.75	3.49	7.10	3.68	7.50	3.69	7.52	4.28	8.70
120	3.62	7.37	3.81	7.75	4.02	8.18	4.03	8.21	4.67	9.49
130	3.92	7.99	4.13	8.40	4.36	8.87	4.37	8.90	5.06	10.29
140	4.23	8.61	4.45	9.05	4.70	9.56	4.71	9.59	5.45	11.08
150	4.54	9.23	4.77	9.70	5.04	10.24	5.05	10.27	5.85	11.88
160	4.84	9.84	5.09	10.35	5.38	10.93	5.39	10.96	-	-
170	5.15	10.46	5.41	11.00	5.72	11.61	5.73	11.65	-	-
180	5.45	11.08	5.73	11.65	6.05	12.30	6.07	12.34	-	-
190	5.76	11.70	6.05	12.30	-	-	-	-	-	-
200	6.06	12.32	6.38	12.95	-	-	-	-	-	-

Screen Size Diagonal (inch)	Projection Distance (m)			
	16:9 image on a 2.35:1 aspect screen		16:9 image on a 2.40:1 aspect screen	
	Wide-end	Tele-end	Wide-end	Tele-end
80	2.01	4.11	1.97	4.03
90	2.26	4.62	2.22	4.54
100	2.52	5.14	2.47	5.05
110	2.77	5.66	2.72	5.56
120	3.03	6.18	2.98	6.07
130	3.29	6.70	3.23	6.58
140	3.54	7.22	3.48	7.09
150	3.80	7.74	3.73	7.60
160	-	-	3.98	8.11
170	-	-	4.24	8.62
180	-	-	4.49	9.13
190	-	-	4.74	9.64
200	-	-	4.99	10.15
210	-	-	5.24	10.66
220	-	-	5.50	11.17
230	-	-	5.75	11.68
240	-	-	6.00	12.19

* The values in the projection table may contain $\pm 5\%$ error. If the product is to be used at the Wide-end or the Tele-end, set a margin of about 5%.

Screen Size Diagonal (inch)	Projection Distance (inch)									
	17:9 Screen		16:9 Screen		2.35:1 Screen		2.40:1 Screen		4:3 Screen	
	Wide-end	Tele-end	Wide-end	Tele-end	Wide-end	Tele-end	Wide-end	Tele-end	Wide-end	Tele-end
60	70.3	144.2	74.0	151.7	78.2	160.2	78.5	160.8	91.0	186.0
70	82.4	168.6	86.7	177.3	91.6	187.2	91.9	187.8	106.5	217.3
80	94.4	192.9	99.3	202.8	104.9	214.2	105.3	214.9	121.9	248.6
90	106.4	217.2	111.9	228.4	118.3	241.2	118.7	242.0	137.4	279.9
100	118.4	241.6	124.6	254.0	131.6	268.2	132.0	269.1	152.9	311.2
110	130.5	265.9	137.2	279.6	145.0	295.2	145.4	296.2	168.3	342.5
120	142.5	290.2	149.9	305.1	158.3	322.2	158.8	323.2	183.8	373.8
130	154.5	314.5	162.5	330.7	171.7	349.2	172.2	350.3	199.3	405.1
140	166.5	338.9	175.1	356.3	185.0	376.2	185.6	377.4	214.8	436.4
150	178.6	363.2	187.8	381.8	198.4	403.2	199.0	404.5	230.2	467.7
160	190.6	387.5	200.4	407.4	211.7	430.2	212.4	431.6	-	-
170	202.6	411.9	213.1	433.0	225.0	457.2	225.8	458.7	-	-
180	214.7	436.2	225.7	458.6	238.4	484.2	239.1	485.7	-	-
190	226.7	460.5	238.4	484.1	-	-	-	-	-	-
200	238.7	484.8	251.0	509.7	-	-	-	-	-	-

Screen Size Diagonal (inch)	Projection Distance (inch)			
	16:9 image on a 2.35:1 aspect screen		16:9 image on a 2.40:1 aspect screen	
	Wide-end	Tele-end	Wide-end	Tele-end
80	78.9	161.7	77.5	158.8
90	89.0	182.1	87.4	178.8
100	99.1	202.5	97.3	198.9
110	109.2	222.9	107.3	218.9
120	119.3	243.3	117.2	239.0
130	129.4	263.8	127.1	259.1
140	139.5	284.2	137.0	279.1
150	149.6	304.6	146.9	299.2
160	-	-	156.8	319.2
170	-	-	166.8	339.3
180	-	-	176.7	359.4
190	-	-	186.6	379.4
200	-	-	196.5	399.5
210	-	-	206.4	419.6
220	-	-	216.3	439.6
230	-	-	226.3	459.7
240	-	-	236.2	479.7

* The values in the projection table may contain $\pm 5\%$ error. If the product is to be used at the Wide-end or the Tele-end, set a margin of about 5%.

Types of Possible Input Signals

Video

Digital Video Signal		480p 576p 720p 50/60 Hz 1080i 50/60 Hz 1080p 24/25/30/50/60/100/120 Hz 2K (2048×1080) 24/25/30/50/60 Hz* 4K (3840×2160) 24/25/30/50/60/100/120 Hz 4K (4096×2160) 24/25/30/50/60/100/120 Hz 8K (7680×4320) 24/25/30/48/50/60 Hz
3D Signal	Frame Packing	720p 50/60 Hz 1080p 24 Hz
	Side-by-side	720p 50/60 Hz 1080p 50/60/24 Hz 1080i 50/60 Hz
	Top-and-bottom	720p 50/60 Hz 1080p 24 Hz

* If the input signal is 2K (2048x1080) 24/25/30/50/60Hz, configure the “Mode” setting in “HDMI EDID Setting” to “B”. (P. 68)

PC signal (HDMI)

Designation	Resolution	fh [kHz]	fv [Hz]	dot CLK [MHz]	Total No. of Dots [dot]	Total No. of Lines [line]	No. of Effective Dots [dot]	No. of Effective Lines [line]
VGA	640×480	31.469	59.940	25.175	800	525	640	480
SVGA	800×600	37.879	60.317	40.000	1056	628	800	600
XGA	1024×768	48.363	60.004	65.000	1344	806	1024	768
WXGA	1280×768	47.776	59.870	79.500	1664	798	1280	768
WXGA	1280×800	49.702	59.810	83.500	1680	831	1280	800
FWXGA	1366×768	47.712	59.790	85.500	1792	798	1366	768
WXGA+	1440×900	55.935	59.887	106.500	1904	934	1440	900
SXGA	1280×1024	63.981	60.020	108.000	1688	1066	1280	1024
WXGA++	1600×900	60.000	60.000	108.000	1800	1000	1600	900
WSXGA+	1680×1050	65.290	59.954	146.250	2240	1089	1680	1050
UXGA	1600×1200	75.000	60.000	162.000	2160	1250	1600	1200
WUXGA	1920×1200	74.556	59.885	193.250	2592	1245	1920	1200
WQHD	2560×1440	88.787	59.951	241.500	2720	1481	2560	1440
WQHD/120	2560×1440	183.000	120.000	497.760	2720	1525	2560	1440

* Even when signals can be input, video images may not be projected properly depending on the PC or cable in use. When this occurs, switching to another compatible resolution or changing the cable may help to resolve the problem in some cases.

Indicator Display on the Main Unit

Meaning of the front panel indicators



The indicator is solid.



The indicator appears blinking.

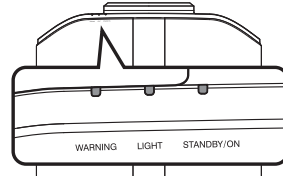

Operation mode display

Displays using the different colors and solid/blinking light of the indicator on the projector unit.

“STANDBY/ON” lights up (red)
• In standby state



“STANDBY/ON” lights up (green)
• When light source is starting up



All lights off
• During projection
• When in “ECO Mode”



“STANDBY/ON” blinking (red)
• In the Cool-down mode



“STANDBY/ON” blinking (green)
• When the video image is temporarily hidden (HIDE is on)















Warning display

You can tell the details of a warning from the (repeated) displays of the “WARNING” and “LIGHT” indicators. The “STANDBY/ON” indicator will light up or appear blinking according to the operation mode of the projector unit. (Please refer to ““Operation mode display”P. 107”.)

The Warning mode is activated once the message is displayed. Projection is interrupted and the cooling fan starts running.

The power cannot be turned on again while cooling is in progress. Check the following after cooling is complete.

If the Warning mode is activated again, wait for the cooling fan to stop, followed by pulling out the power plug from the outlet. Then pull out the power plug from the power outlet. Call your authorized dealer for repair.

Indicator Status			Blinking Frequency	Description	Check and Countermeasure
WARNING	LIGHT	STANDBY/ON			
 WARNING (Red)	 LIGHT	 STANDBY/ON Mode Display	x2	Cooling fan stopped abnormally	<ul style="list-style-type: none"> • Check that nothing is blocking the air inlets. • Check that the external temperature is normal. Countermeasure: Leave the unit unoperated until it cools down. After that, turn on the power again.
			x3	Internal temperature is abnormally high	
			x4	External temperature is too high	
 WARNING (Red)	 LIGHT (Orange)	 STANDBY/ON Mode Display	x1	DD board occurs error	
			x2	Fan motor board occurs error	
			x3	CPU board occurs error	
			x4	Power board occurs error	
 WARNING (Red)	 LIGHT (Orange)	 STANDBY/ON Mode Display	x1	Abnormality in the light source	Request for repair at your authorized dealer or a nearby service center.
			x2		
			x3		
			x4	When the safety switch is activated	
 WARNING	 LIGHT	 STANDBY/ON (Green)	x3	The remote control code differs between this unit and the remote control	Set the remote control code for this unit and the remote control correctly.

Dimensions

(Unit: mm)

NZ900 RS4200

Top Surface

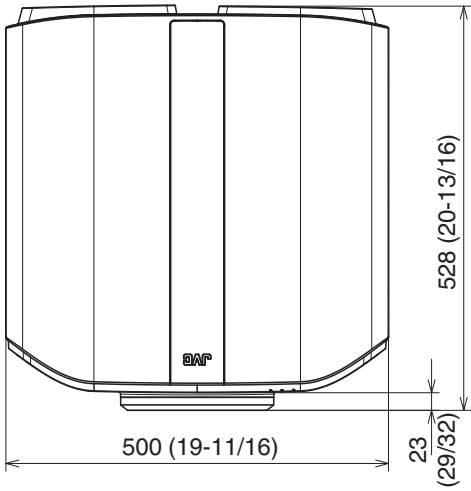

Bottom Surface

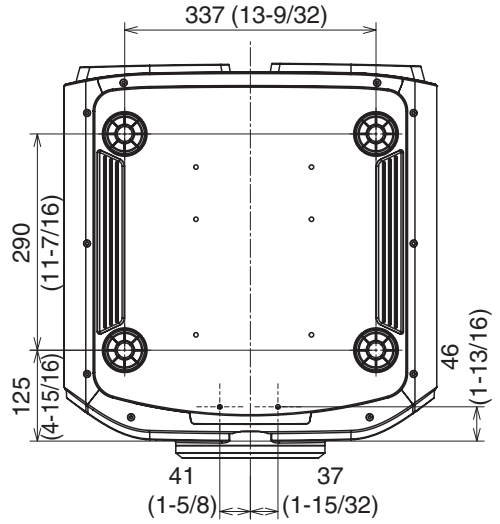

Front

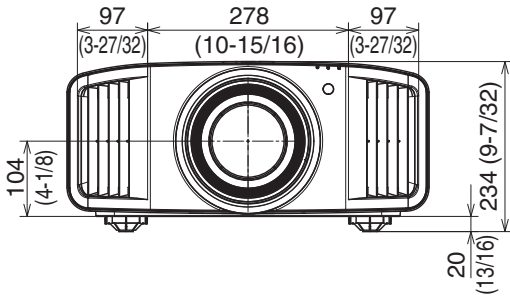

Rear Surface

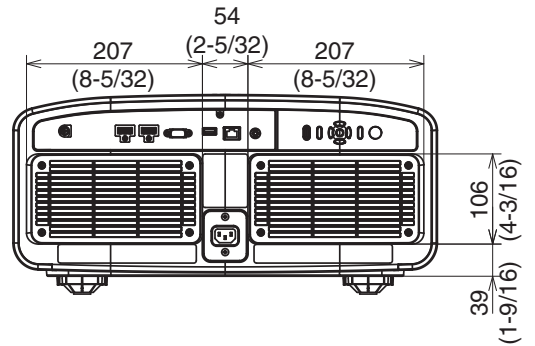

Top Surface

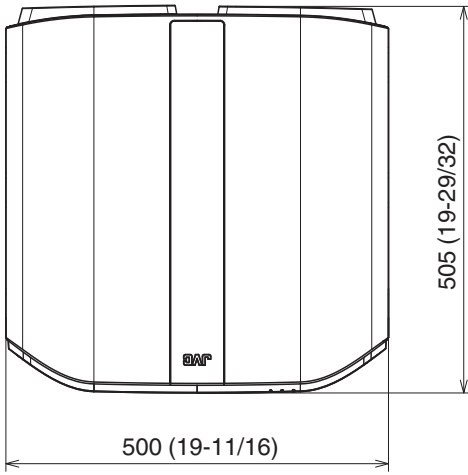

Bottom Surface

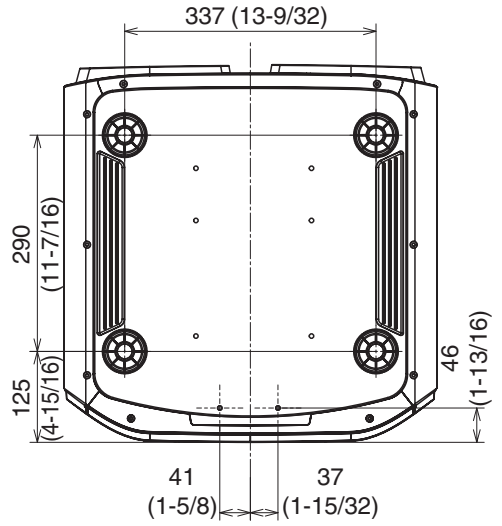

Front

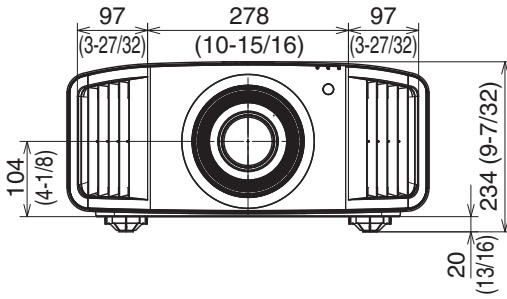

Rear Surface

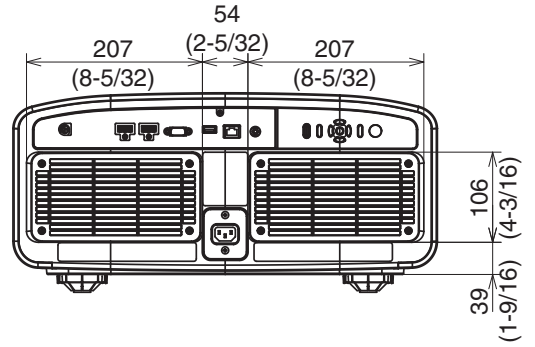

Software License Agreement

The software embedded in the Product (hereinafter the “Licensed Software”) provided by JVCKENWOOD Corporation (hereinafter the “Licensor”) is copyrighted to or sublicensable by the Licensor, and this Agreement provides for the terms and conditions which Users shall follow in order to use the Licensed Software. The User shall use the Licensed Software by agreeing with the terms of this Software License Agreement. This Agreement shall be deemed completed at the time the User (hereinafter the “User”) initially used the Product in which the “Licensed Software” is embedded.

The Licensed Software may include the software which has been licensed to the Licensor directly or indirectly from any third party. In such case, some third parties require the Users to follow their conditions for use separately from this Software License Agreement. Such software shall not be subject to this Agreement, and the Users are urged to read the ““Important Notice concerning the Software”P. 113” to be provided separately.

Article 1 General Provision

The Licensor shall grant to the User a non-exclusive and non-transferable (other than the exceptional case referred to in Article 3, Paragraph 1) licensed to use the Licensed Software within the country of the User (the country where the User bought the Product (hereinafter the “Country”)).

Article 2 License

1. The license granted under this Agreement shall be the right to use the Licensed Software in the Product.
2. The User shall not duplicate, copy, modify, add, translate or otherwise alter, or lease the Licensed Software and any related documents, whether in whole or in part.
3. The use of the Licensed Software shall be limited to personal purpose, and the Licensed Software shall not be distributed, licensed or sub-licensed whether it is for commercial purpose or not.
4. The User shall use the Licensed Software according to the directions described in the operation manual or help file, and is prohibited to use or duplicate any data in a manner violating the Copyright Law or any other laws and regulations by applying whole or a part of the Licensed Software.

Article 3 Conditions for Grant of License

1. When the User transfers the Product, it may also transfer the license to use the Licensed Software embedded in the Product (including any related materials, updates and upgrades) on condition that no original, copies or related materials continue in the possession of the User, and that the User shall cause the transferee to comply with this Software License Agreement.
2. The User shall not carry out reverse engineering, disassembling, decompiling or any other code analysis works in connection with the Licensed Software.

Article 4 Right pertaining to the Licensed Software

1. Any and all copyrights and other rights pertaining to the Licensed Software and related documents shall belong to the Licensor or the original holder of the right who granted to the Licensor the license or sublicense for the Licensed Software (hereinafter the “Original Rightholder”), and the User shall not be entitled to any right other than the license granted hereunder, in respect of the Licensed Software and any related documents.
2. The User shall, whenever the User uses the Licensed Software, comply with any laws relating to the copyright and other intellectual property rights.

Article 5 Indemnification of Licensor

1. Neither the Licensor nor the Original Rightholder shall be liable for any damage incurred by the User or any third party due to the exercise of the license granted to the User under this Agreement, unless otherwise restricted by law.
2. The Licensor will offer no guarantee for the merchantability, convertibility and consistency with certain objective of the Licensed Software.

Article 6 Liability to Third Party

If any dispute has arisen with any third party due to an infringement upon a copyright, patent or any other intellectual property right that was caused by the User’s use of the Licensed Software, the User shall settle such dispute at the User’s own cost and hold the Licensor and the Original Rightholder harmless from any inconvenience it may cause.

Article 7 Confidentiality

The User shall keep the confidentiality of such portion of the Licensed Software, related documents thereof or any other information to be granted under this Agreement, as well as the conditions of this Agreement as has not yet entered the public domain, and shall not disclose or divulge the same to any third party without approval of the Licensor.

Article 8 Termination

In case the User falls under any of the events described in the following items, the Licensor may immediately terminate this Agreement or claim that the User compensates for the damage incurred by the Licensor due to such event:

- (1) when the User violated any provision of this Agreement; or
- (2) when a petition has been filed against the User for an attachment, provisional attachment, provisional disposition or any other compulsory execution.

Article 9 Destruction of the Licensed Software

If this Agreement is terminated pursuant to the provision of Article 8, the User shall destroy the Licensed Software, any related documents and copies thereof within two (2) weeks from such date of termination.

Article 10 Export Restriction

1. The User shall understand that the Licensed Software shall be subject to the export restrictions adopted by the country of User and any other countries.
2. The User shall agree that the software will be subject to any and all applicable international and domestic laws including the export control regulation of the country of User and any other countries, and any restrictions concerning the end-users, the use by end-users and importing countries to be provided by the country of User and any other countries, and any other governmental authorities.
3. If the User is an agency of the United States of America (the "Government"), the User acknowledge Licensor's representation that the Licensed Software is a "Commercial Item" as defined in Federal Acquisition Regulation (FAR) part 2.101(g) consisting unpublished "Commercial Computer Software" as those items are used at FAR part 12.212 and is only license the User with the same use right Licensor grants all commercial end users pursuant to the terms of this Agreement.

Article 11 Miscellaneous

1. In the event any part of this Agreement is invalidated by operation of law, the residual provisions shall continue in force.
2. Matters not stipulated in this Agreement or any ambiguity or question raised in the construction of this Agreement shall be provided or settled upon good-faith consultation between the Licensor and the User.
3. The Licensor and the User hereby agree that this Agreement is governed by the laws of Japan, and any dispute arising from, and relating to the rights and obligations under, this Agreement shall be submitted to the exclusive jurisdiction of the Tokyo District Court for its first instance.

Important Notice concerning the Software

Software License Attached to the Product :

The Software embedded in the Product is composed of several independent software components, and in each of such individual components (hereinafter the “Licensed Software”), a copyright of either JVCKENWOOD Corporation (hereinafter “JKC”) or a third party subsists.

The Product uses the software component designated in the End-User License Agreement that was executed between JKC and a third party (hereinafter “EULA”).

The Licensed Software covers those corresponding to free software, and, as a condition of distribution of the software component in executable format which is based on the license granted under the GNU General Public License or Lesser General Public License (hereinafter “GPL/LGPL”), it requires an availability of the source code for the relevant component.

Please refer to the following URL concerning the distribution of the source code;

<https://www3.jvckenwood.com/english/download/gpl/index.html>

Please note that we are unable to answer any inquiry relating to the contents, etc. of the source code. In addition, the Licensed Software includes the software developed or created independently by JKC and there exists an ownership of JKC in such software and any accompanying documents, which is protected by the Copyright Law, any international treaties and other applicable laws. As to matters concerning the handling by JKC of the software components, please refer to the “Software License Agreement” attached hereto. Please note that any software component licensed under “EULA” which is not subject to “GPL/LGPL,” and those developed or created independently by JKC shall not be subject to the requirement for provision of the source code. The software component distributed under “GPL/LGPL” shall be licensed to users without charge, and, therefore, no warranty is given for such software component, either express or implied, within the scope of the applicable laws and regulations. Unless otherwise permitted by applicable laws and regulations or agreed in written form, none of the owners of the copyright or persons entitled to alter or redistribute the software component under the said license shall have any liability for any type of damage or loss resulting from the use of or inability to use such software component. For further details of the conditions of use of such software component or matters required to be complied with, please refer to the relevant “GPL/LGPL”.

Users are urged to read the details for the relevant license carefully before using the software component covered by “GPL/LGPL” and embedded in the Product. Since the terms and conditions of individual licenses are provided by parties other than JKC, the original English version will be displayed by the Product menu screen.

- ① Turn on the power of the projector.
- ② Press the [MENU] button.
- ③ Select [Function]→[License].

Index

- A Accessories..... 13
 - Adjust (Fine)71
 - Adjust (Pixel Adjust).....71
 - Adjust (Pixel)71
 - Adjust Area 71
 - Adjust Color 71
 - Adjust Pattern 71
 - Adjust Pattern Color 71
 - Adjusting Distortion of the Projection Screen.....28
 - Adjusting the Position..... 22
 - Adjustments and Settings in the Menu.....53
 - Anamorphic 75
 - Aperture 57
 - Aspect29
 - Auto Pic.Mode Select67
 - Auto Tone Mapping43

- B Back Color 77
- Back-up Settings.....81
- BNR 65
- Bright Level 44, 49, 49
- Brightness (Color Management)..... 37, 59
- Brightness (More Settings)..... 58

- C Cleaning and Replacing the Filter..... 84
- Clear Motion Drive..... 52
- Clear Motion Drive 52, 65
- Color 58
- Color Management 37, 59
- Color Profile 37, 59
- Color Selection (Color Management)..... 37, 59
- Color Selection (Gamma/Tone Mapping).....49, 62
- Color Space (Information).....83
- Color Space (Input Signal).....66
- Color Temp. 59
- Colorimetry 83
- Connecting the Projector..... 23
- Content Type 32, 56
- Contrast 58
- Controls and Features..... 14
- Correction Value (Color Temp.)..... 61
- Correction Value (Gamma/Tone Mapping)..... 50, 62
- Crosstalk Cancel31

- D Dark Level 44, 49, 49
- Deep Black 64
- Default Gateway 79
- DHCP Client79
- Dimensions..... 109
- Display Setup77
- DSC 68
- Dynamic CTRL57

- ECO Mode 78
- Enhance65
- Export Settings..... 81
- External Control..... 92

- F Factory Reset 82
- FILMMAKER MODE 68
- Focus 28
- Frame Interpolation.....52
- Function 78

- G Gain Blue 61
- Gain Green 61
- Gain Red 61
- Gamma 46, 49, 62
- Graphic Mode 65

- H H Frequency 83
- HDMI EDID Setting 68
- HDR 83
- HDR Feature on This Unit..... 38
- HDR Processing 63
- HDR Quantizer 63
- HDR Settings 63
- HDR10 67
- HDR10+ 68
- Hide Mode..... 26
- High Altitude Mode81
- HLG 67
- Hue 37, 59

- I Image Pattern70
- Import Settings.....81
- Indicator Display..... 107
- Information 83
- Input (Information).....83
- Input Level (Input Signal)..... 66
- Input Signal 66
- Input Terminal..... 16
- Installation 69
- Installation Method.....20
- Installation Mode 69
- Installation Style 77
- IP Address 79

- K Keystone77

- L LAN Terminal..... 16, 24, 92
- Language 78
- LD Power 56
- Lens..... 14
- Lens Center 70
- Lens Control28, 70

Lens Cover.....	13	S Saturation	37, 59
License	82	Screen Adjust	76
Light Source Time	83	Screen Aspect	76
List of Menu Items.....	53	Screen Gain	76
Lock	70	Screen No.	76
Logo	78	Screen Setting	76
Low Latency	51, 65	Screen Size and Projection Distance.....	98
M MAC Address	79	Screen Size(Diagonal)	76
Mapping Level	64	SDR(2D)/SDR(3D)	67
Mask	75	Securing (Mounting) the Projector.....	21
Max CLL/FALL/DML	83	Securing the Projector (Ceiling Mount).....	21
Menu.....	19	SERVICE Terminal.....	16, 82
Menu Position	77	Shift	28
MNR	65	Signal Display	77
Mode	68	Signal Display.....	83
Mode Copy	69	Soft Ver.	83
Mode Select	69	Software Update	82
More Settings	56	Source	83
Motion Control	51, 65	Specifications.....	96
Motion Enhance	52, 65	Subnet Mask	79
MPC/e-shift	65	T Theater Optimizer	62
N Name Edit	69	Tint	58
Network	79	Tone Mapping	44, 46, 49, 62
Network Password	79	Trigger	78
NR	65	Troubleshooting.....	86
O Off Timer	78	Types of Possible Input Signals.....	106
Offset Blue	61	U User Name Edit	58
Offset Green	61	V V Frequency	83
Offset Red	61	Viewing 3D Movies.....	30
Optional Accessories.....	13	Viewing HDR Content.....	38
P Parallax	31	Viewing Videos.....	26
Partial Adjustment (Zone Adjust).....	71, 74	W When the Following Messages Appear.....	91
Picture Adjust	56	Whole Adjust (Fine).....	71, 73
Picture Mode	32, 56	Whole Adjust (Pixel).....	72
Picture Tone	44, 49, 49	Z Zoom	28
Pixel Adjust	71	Alphanumeric	
Power Cord.....	13, 13, 25	3D Format	31
Precautions during Installation.....	20	3D Glasses	13, 30
Projection Distance.....	98	3D Setting	31, 66
R Remote Code	80	3D Synchro Emitter	13, 30
Resolution	83	8K e-shift	65
RS-232C Terminal.....	16, 24, 92		

DLA-NZ900/DLA-NZ800/DLA-RS4200/DLA-RS3200
D-LILA PROJECTOR

JVC