



ENGLISH

MONITOR WITH RECEIVER
INSTRUCTION MANUAL

JVCKENWOOD Corporation

KW-M540BT

This instruction manual is used to describe the models listed above. Model availability and features (functions) may differ depending on the country and sales area.

B5A-2154-20 (E)

Important Notice

To ensure proper use, please read through this manual before using this product. It is especially important that you read and observe WARNINGS and CAUTIONS in this manual.

Please keep the manual in a safe and accessible place for future reference.

WARNINGS

To prevent accidents and damages

- DO NOT install any unit or wire any cable in a location where;
 - it may obstruct the steering wheel and gearshift lever operations.
 - it may obstruct the operation of safety devices such as air bags.
 - it may obstruct visibility.
- DO NOT raise the volume level too much, as this will make driving dangerous by blocking outside sounds, and may cause hearing loss.
- DO NOT operate the unit while driving. If you need to operate the unit while driving, be sure to look around carefully.
- Stop the car before performing any complicated operations.
- The driver must not watch the monitor while driving.

CAUTIONS

To care for the unit

- If you have parked the car for a long time in hot or cold weather, wait until the temperature in the car becomes normal before operating the unit.

To care for the monitor

- The monitor built into this unit has been produced with high precision, but it may have some ineffective dots. This is inevitable and is not considered defective.
- Do not expose the monitor to direct sunlight.
- Do not operate the touch panel using a ball-point pen or similar tool with a sharp tip.
Touch the keys on the touch panel with your finger directly (if you are wearing a glove, take it off).
- When the temperature is very cold or very hot...
 - Chemical changes occur inside, causing malfunction.
 - Pictures may not appear clearly or may move slowly. Pictures may not be synchronized with the sound or picture quality may decline in such environments.

On the volume setting

- Digital devices produce very little noise compared with other sources. Lower the volume before playing these digital sources to avoid damaging the speakers by sudden increase of the output level.

For Israel

מידע בדבר השלכה לאשפה של ציוד חשמלי ואלקטרוני ישן וכן סוללות (רלוונטי למדינות שמשממשות במערכת איסוף אשפה מופרדת).

לא ניתן להשליך מוצרים וסוללות עם הסימון (פח אשפה עם X עליו) כאשפה ביתית רגילה. יש למחזר ציוד חשמלי ואלקטרוני ישן וכן סוללות במתקן המסוגל לטפל בפריטים כאלה ובתוצרי הלואי שלהם.

צרו קשר עם הרשות המקומית לקבלת פרטים אודות מתקן המיחזור הקרוב אליכם. מיחזור והשלכה לאשפה נאותים יעזרו לשמר משאבים ולמנוע השפעות שליליות על בריאותנו ועל הסביבה.

שימו לב: הסימון Pb שמתחת לסימון עבור סוללות מצוין שהסוללה מכילה עופרת.

Important Notice



Pb

Information on Disposal of Old Electrical and Electronic Equipment and Batteries (applicable for countries that have adopted separate waste collection systems)

Products and batteries with the symbol (crossed out wheeled bin) cannot be disposed as household waste. Old electrical and electronic equipment and batteries should be recycled at a facility capable of handling these items and their waste byproducts.

Contact your local authority for details in locating a recycle facility nearest to you.

Proper recycling and waste disposal will help conserve resources whilst preventing detrimental effects on our health and the environment.

Notice: The sign "Pb" below the symbol for batteries indicates that this battery contains lead.



Declaration of Conformity with regard to the RE Directive 2014/53/EU

Declaration of Conformity with regard to the RoHS Directive 2011/65/EU

Manufacturer:

JVC KENWOOD Corporation
3-12, Moriya-cho, Kanagawa-ku, Yokohama-shi,
Kanagawa, 221-0022, Japan

EU Representative:

JVCKENWOOD Deutschland GmbH
Konrad-Adenauer-Allee 1-11, 61118 Bad Vilbel,
GERMANY

English

Hereby, JVCKENWOOD declares that the radio equipment "KW-M540BT" is in compliance with Directive 2014/53/EU.

The full text of the EU declaration of conformity is available at the following internet address:

<http://www.jvc.net/cs/car/eudoc/>

Français

Par la présente, JVCKENWOOD déclare que l'équipement radio « KW-M540BT » est conforme à la directive 2014/53/UE.

L'intégralité de la déclaration de conformité UE est disponible à l'adresse Internet suivante :

<http://www.jvc.net/cs/car/eudoc/>

Deutsch

Hiermit erklärt JVCKENWOOD, dass das Funkgerät "KW-M540BT" der Richtlinie 2014/53/EU entspricht.

Der volle Text der EU-Konformitätserklärung steht unter der folgenden Internetadresse zur Verfügung:

<http://www.jvc.net/cs/car/eudoc/>

Nederlands

Hierbij verklaart JVCKENWOOD dat de radioapparaatuur "KW-M540BT" in overeenstemming is met Richtlijn 2014/53/EU.

De volledige tekst van de EU-verklaring van overeenstemming is te vinden op het volgende internetadres:

<http://www.jvc.net/cs/car/eudoc/>

Important Notice

Italiano

Con la presente, JVCKENWOOD dichiara che l'apparecchio radio "KW-M540BT" è conforme alla Direttiva 2014/53/UE.

Il testo integrale della dichiarazione di conformità UE è disponibile al seguente indirizzo internet:
<http://www.jvc.net/cs/car/eudoc/>

Español

Por la presente, JVCKENWOOD declara que el equipo de radio "KW-M540BT" cumple la Directiva 2014/53/EU. El texto completo de la declaración de conformidad con la UE está disponible en la siguiente dirección de internet:

<http://www.jvc.net/cs/car/eudoc/>

Português

Deste modo, a JVCKENWOOD declara que o equipamento de rádio "KW-M540BT" está em conformidade com a Diretiva 2014/53/UE. O texto integral da declaração de conformidade da UE está disponível no seguinte endereço de internet:

<http://www.jvc.net/cs/car/eudoc/>

Polska

Niniejszym, JVCKENWOOD deklaruje, że sprzęt radiowy "KW-M540BT" jest zgodny z dyrektywą 2014/53/UE.

Pełny tekst deklaracji zgodności EU jest dostępny pod adresem:

<http://www.jvc.net/cs/car/eudoc/>

Český

Společnost JVCKENWOOD tímto prohlašuje, že rádiové zařízení "KW-M540BT" splňuje podmínky směrnice 2014/53/EU.

Plný text EU prohlášení o shodě je dostupný na následující internetové adrese:
<http://www.jvc.net/cs/car/eudoc/>

Magyar

JVCKENWOOD ezennel kijelenti, hogy a „KW-M540BT” rádióberendezés megfelel a 2014/53/EU irányelvnek. Az EU konformitási nyilatkozat teljes szövege az alábbi weboldalon érhető el:

<http://www.jvc.net/cs/car/eudoc/>

Svenska

Härmed försäkrar JVCKENWOOD att radioutrustningen "KW-M540BT" är i enlighet med direktiv 2014/53/EU. Den fullständiga texten av EU-försäkran om överensstämmelse finns på följande Internetadress:
<http://www.jvc.net/cs/car/eudoc/>

Suomi

JVCKENWOOD julistaa täten, että radiolaite "KW-M540BT" on direktiivin 2014/53/EU mukainen. EU-vaatimustenmukaisuusvakuutusvaatim us löytyy kokonaisuudessaan seuraavasta internet-osoitteesta:
<http://www.jvc.net/cs/car/eudoc/>

Slovensko

S tem JVCKENWOOD izjavlja, da je radijska oprema »KW-M540BT« v skladu z Direktivo 2014/53/EU. Celotno besedilo direktive EU o skladnosti je dostopno na tem spletnem naslovu:
<http://www.jvc.net/cs/car/eudoc/>

Slovensky

Spoločnosť JVCKENWOOD týmto vyhlasuje, že rádiové zariadenie „KW-M540BT” vyhovuje smernici 2014/53/EÚ. Celý text EÚ vyhlásenia o zhode nájdete na nasledovnej internetovej adrese:
<http://www.jvc.net/cs/car/eudoc/>

Dansk

Herved erklærer JVCKENWOOD, at radioudstyret "KW-M540BT" er i overensstemmelse med Direktiv 2014/53/EU. EU-overensstemmelseserklæringens fulde ordlyd er tilgængelig på følgende internetadresse:
<http://www.jvc.net/cs/car/eudoc/>

Ελληνικά

Με το παρόν, η JVCKENWOOD δηλώνει ότι ο ραδιοεξοπλισμός «KW-M540BT» συμμορφώνεται με την Οδηγία 2014/53/ΕΕ. Το πλήρες κείμενο της δήλωσης συμμόρφωσης της ΕΕ είναι διαθέσιμο στην ακόλουθη διεύθυνση στο διαδίκτυο:
<http://www.jvc.net/cs/car/eudoc/>

Important Notice

Eesti

Käesolevaga JVCKENWOOD kinnitab, et „KW-M540BT“ raadiovarustus on vastavuses direktiiviga 2014/53/EL. ELi vastavusdeklaratsiooni terviktekst on kättesaadav järgmisel internetiaadressil:
<http://www.jvc.net/cs/car/eudoc/>

Latviešu

JVCKENWOOD ar šo deklarē, ka radio aparatūra „KW-M540BT“ atbilst direktīvas 2014/53/ES prasībām. Pilns ES atbilstības deklarācijas teksts ir pieejams šādā tīmekļa adresē:
<http://www.jvc.net/cs/car/eudoc/>

Lietuviškai

Šiuo JVCKENWOOD pažymi, kad radijo įranga „KW-M540BT“ atitinka 2014/53/EB direktyvos reikalavimus. Visą EB direktyvos atitikties deklaracijos tekstą galite rasti šiuo internetiniu adresu:
<http://www.jvc.net/cs/car/eudoc/>

Malti

B'dan, JVCKENWOOD jiddikjara li t-tagħmir tar-radju "KW-M540BT" huwa konformi mad-Direttiva 2014/53/UE. It-test kollu tad-dikjarazzjoni ta' konformità huwa disponibbli fl-indirizz intranet li ġej:
<http://www.jvc.net/cs/car/eudoc/>

HRVATSKI / SRPSKI JEZIK

JVCKENWOOD ovim izjavljuje da je radio oprema "KW-M540BT" u skladu s Direktivom 2014/53/EU. Cjeloviti tekst deklaracije Europske unije o usklađenosti dostupan je na sljedećoj internet adresi:
<http://www.jvc.net/cs/car/eudoc/>

ROMÂNĂ

Prin prezenta, JVCKENWOOD declară că echipamentul radio "KW-M540BT" este în conformitate cu Directiva 2014/53/UE. Textul integral al declarației de conformitate UE este disponibil la urmatoarea adresă de internet:
<http://www.jvc.net/cs/car/eudoc/>

БЪЛГАРСКИ

С настоящото JVCKENWOOD декларира, че радиооборудването на "KW-M540BT" е в съответствие с Директива 2014/53/ЕС. Пълният текст на ЕС декларацията за съответствие е достъпен на следния интернет адрес:
<http://www.jvc.net/cs/car/eudoc/>

Turkish

Burada, JVCKENWOOD "KW-M540BT" radyo ekipmanının 2014/53/AB Direktifine uygun olduğunu bildirir. AB uyumluluk deklarasyonunun tam metni aşağıdaki internet adresinde mevcuttur.
<http://www.jvc.net/cs/car/eudoc/>

Русский

JVCKENWOOD настоящим заявляет, что радиооборудование «KW-M540BT» соответствует Директиве 2014/53/EU. Полный текст декларации соответствия ЕС доступен по следующему адресу в сети Интернет:
<http://www.jvc.net/cs/car/eudoc/>

Українська

Таким чином, компанія JVCKENWOOD заявляє, що радіообладнання «KW-M540BT» відповідає Директиві 2014/53/EU. Повний текст декларації про відповідність ЄС можна знайти в Інтернеті за такою адресою:
<http://www.jvc.net/cs/car/eudoc/>

About this manual

The displays and panels shown in this manual are examples used to provide clear explanations of the operations. For this reason, they may be different from the actual displays or panels.

This manual mainly explains operations using the buttons on the monitor panel and keys on the touch panel. For operations using the remote controller, see page 34.

< > indicates the various screens/menus/operations/settings that appear on the touch panel.

[] indicates the keys on the touch panel.

Indication language: English indications are used for the purpose of explanation. You can select the indication language from the <SETUP> menu. (Page 32)

Contents

Component Names and Operations	3	Bluetooth®	20
Basic Operations	3	Information	20
Turning on the power	3	Preparation	20
Turning off the power	3	Connection.....	20
Turning off the AV source	3	Bluetooth mobile phone.....	22
Adjusting the volume.....	3	Bluetooth audio player	25
Attenuating the sound	3	Bluetooth mobile phone settings.....	26
Turning off the screen.....	3	Settings	26
Getting Started	4	Audio settings	26
Initial settings	4	Display settings.....	31
Setting the security code	4	User interface settings.....	32
Calendar/clock settings	5	Camera settings	32
Various Screens and Operations	5	Special system settings.....	33
Touch screen operations.....	5	Bluetooth settings	34
Home screen.....	5	Security settings.....	34
Source control screen.....	7	Remote Controller.....	34
List/setting screen.....	9	Preparation	34
Video	9	Basic operations	35
USB	10	Searching for a station frequency directly	36
iPod/iPhone	11	JVC Remote APP.....	36
Apps—WebLink™	12	Installation and Connection	36
Tuner	14	Before installation	36
Spotify	17	Installing the unit.....	38
Other External Components	19	Removing the unit	38
Rear view camera	19	Connecting external components	38
AV-IN.....	19	Wiring connection	39
Bluetooth®	20	References	40
Information	20	Maintenance	40
Preparation	20	More information	40
Connection.....	20	Troubleshooting.....	42
Bluetooth mobile phone.....	22	Specifications	44
Bluetooth audio player	25	Trademarks and licenses.....	46
Bluetooth mobile phone settings.....	26		

Component Names and Operations



1 Volume +/- buttons

2 **FNC** button

- (Press) Turns on the power.
- (Press) Pops up the short-cut menu while the power is on.
- (Hold) Activates the voice dialing.

3 Monitor panel

4 Screen (touch panel)

5 Remote sensor*

* DO NOT expose the remote sensor to bright light (direct sunlight or artificial lighting).

Basic Operations

Turning on the power



Turning off the power

1 Display the source/option selection screen.

On the Home screen, touch as follows:



2 Turn off the power.

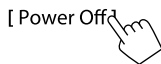

Turning off the AV source

1 Display the source/option selection screen.

On the Home screen, touch as follows:



2 Turn off the AV source.

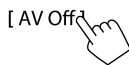

Adjusting the volume

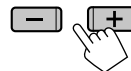

You can adjust the volume (00 to 40) by pressing + to increase and pressing – to decrease.

- Holding + increases the volume continuously to level 15.

Attenuating the sound

On the source control screen, touch as follows:



The ATT indicator lights up.

To cancel attenuation: Touch [Speaker icon] again.

Turning off the screen

1 Display the pop-up short-cut menu.



2 Turn off the screen.



To turn on the screen: Press FNC on the monitor panel or touch the screen.

Getting Started

Initial settings

When you power on the unit for the first time, the <Initial SETUP> screen appears.

Perform the initial settings.

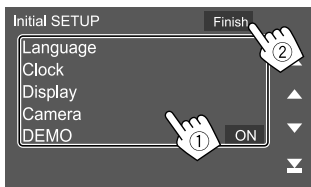

E.g. Initial settings screen

Once completed, a warning message appears. Touch [Agree] to display the Home screen.

[Language]

Select the text language used for on-screen information.

Touch [Language Select], then select the language.

- **American English (en)/British English (en)** (Initial)/**Nederlands (nl)/Français (fr)/Deutsch (de)/Italiano (it)/Español (es)/(ar) العربية/Ελληνικά (el)/Português (pt)/Čeština (cs)/Polski (pl)/Magyar (hu)/Русский (ru)/עברית (th)/Türkçe (tr)/中文 (zh)/(he) עברית (fa) فارسی/Bahasa Melayu (ms)/Bahasa Indonesia (id)**

[Clock] (Page 5)

Set the calendar and clock time.

Make the settings for [Clock], [Time Zone] or [Clock Adjust].

[Display] (Page 31)

Make the settings to adjust the display.

[Camera] (Page 32)

Make the settings to display the picture from the connected rear view camera.

[DEMO]

- **ON** (Initial): Activates the display demonstration.
- **OFF**: Deactivates the display demonstration.

Setting the security code

You can set a security code (four-digit number of your choice) to protect your receiver system against theft. Once you set the security code, you are required to input the security code when the power is on to reconnect the battery.

1 Display the <Security Code Set> screen.

On the Home screen, touch as follows:



Then, on the <SETUP> screen, touch as follows:

[Security] → [Security Code Set]

2 Enter a four-digit number (1), then confirm the entry (2).

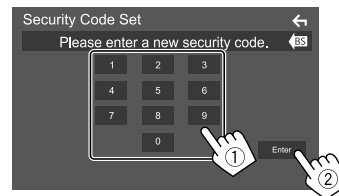

- To clear the last entry, touch [BS].
- To cancel the setting, touch [←].

3 Enter the four-digit number entered in step 2 and touch [Enter] again to confirm your security code.

To change the security code: Touch [Security Code Change] on the <Security> screen on step 1, then repeat steps 2 and 3.

To clear the security code: Touch [Security Code Cancellation] on the <Security> screen on step 1, then repeat step 2.

Getting Started

Calendar/clock settings

1 Display the <User Interface> screen.

On the Home screen, touch as follows:



Then, on the <SETUP> screen, touch [User Interface].

2 Set the date and clock.

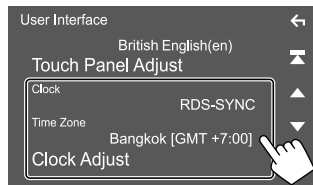

[Clock]

Select the method to set the date and clock.

- **RDS-SYNC** (Initial): Synchronizes the clock with the FM Radio Data System.
- **Manual**: Sets the date and clock manually.

[Time Zone]*

Select the time zone for your area.

[Clock Adjust]*

Set the date and clock manually when [Clock] is set to [Manual].

Touch [▲]/[▼] to adjust the date (year/month/date), then clock (hour/minute). To finish setting, touch [Set].

* Available when [Clock] is set to [Manual].

Various Screens and Operations

You can display or change to other screens at any time to show information, change the AV source, change the settings, etc.

Touch screen operations

To perform operations on the screen, you need to touch, touch and hold, flick or swipe to select an item, display setting menu screen or to change the page, etc.

Touch

Touch the screen gently to select an item on the screen.



Touch and hold

Touch the screen and keep your finger in place until the display changes or a message is displayed.



Flick

Slide your finger to the left or right on the screen to change the page.



Swipe

Slide your finger up or down on the screen to scroll the screen.



Home screen

When you turn on the power for the first time, the Home screen appears.

- You can customize the Home screen.
- To display the Home screen from other screens, press **FNC** on the monitor panel, then touch [Home] on the pop-up short-cut menu.

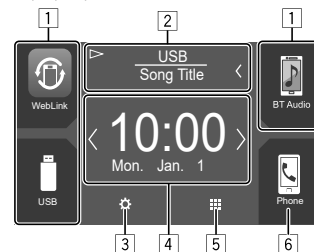

Touching the operation keys performs the following actions:

- 1 Short-cut playback source keys
- 2 Current source information
 - Touch to display the current playing source control screen.
 - Touching [◀] scrolls the text if not all of the text is shown.
- 3 Displays the <SETUP> screen
- 4 Widget
 - You can change the widget by touching [◀/▶].
 - Touch the widget to display the detailed screen.
- 5 Displays all playback sources and options
- 6 Displays the phone control screen

Various Screens and Operations

Available playback sources and options

Touch [5] to display the source/option selection screen.

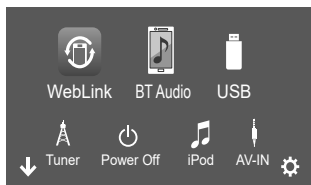

E.g. Source/option selection screen

Touching the operation keys performs the following actions:

[WebLink]	Switches to the WebLink™ application.
[BT Audio]	Plays a Bluetooth audio player.
[USB]	Plays files on a USB device.
[Tuner]	Switches to the radio broadcast.
[Power Off]	Turns off the power.
[iPod]	Plays an iPod/iPhone.
[AV-IN]	Switches to an external component connected to the AV-IN input terminal.
[Spotify]	Switches to the Spotify application.
[Audio]	Displays the sound adjustment screen.
[AV Off]	Turns off the AV source.
[⚙️]	Displays the <SETUP> screen.

To change the page: Touch [⏪/⏩]. Current page is shown by the page indication on the bottom of the screen.

To return to the Home screen: Touch [⏴] on the source/option selection screen.

Customizing the source/option selection screen

You can arrange the items to display on the source/option selection screen.

1 Select an item to move.

Touch and hold the item you want to move until boxes appear around the icons.

2 Drag the selected item to the position you want to move it to.

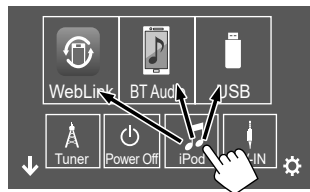

E.g. Source/option selection screen

About short-cut playback source keys on the Home screen

The three items displayed on the top of the source/option selection screen with large icons are also shown on the Home screen as the short-cut playback source keys. You can set the source keys which you use frequently and access quickly from the Home screen.

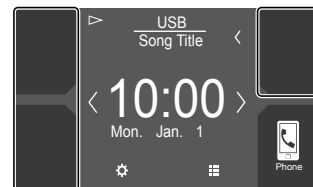

Various Screens and Operations

Source control screen

You can perform the playback operation from the source control screen during playback.

- The operation keys and information displayed vary depending on the selected source/file type being played.
- If the operation keys are not displayed on the screen, touch the screen to show them.

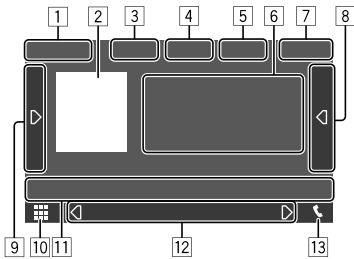

E.g. Common audio playback source screen

- 1 Playback source or media type
- 2 Picture data/artwork (shown if the file contains artwork)
- 3 For video: Hides the operation buttons on the screen while video is played
 - Touch the screen to restore the operation buttons.

For audio: File format
- 4 Repeat/random playback mode keys*

- 5 Information about connected device
 - For Bluetooth device: Signal strength and battery level (only when the information is acquired from the device)
- 6 Track/file/song/video information
 - Touching [◀] scrolls the text if not all of the text is shown.
- 7 Lock display
- 8 Displays the track/file/station list
- 9 Displays/hides other available operation keys*
- 10 Displays the source/option selection screen
- 11 Operation keys*
- 12 Secondary screen

Each time you touch [◀/▶], the items shown on the secondary screen change as follows:

- Indicators: Displays the current source conditions, etc.

The followings are the common indicators:

 - **ATT**: The sound is attenuated.
 - **LOUD**: The loudness is active.
 - **MUSIC/VIDEO**: Music/video file is played back.
- Short-cut buttons: Changes the source from those you have located on the Home screen.

- 13 Displays the phone control screen

* See the following "Common operation keys on source control screen".

Common operation keys on source control screen

- The appearance of the operation keys may differ, however the similar operation keys have the same operations.
- Available operation keys differ depending on the selected source or connected device.

Touching the operation keys performs the following actions:

[⏮]*	Selects repeat playback mode. <ul style="list-style-type: none"> • : Repeat one • : Repeat folder • ALL: Repeat all • (gray): Off
[⏮]*	Selects random playback mode. <ul style="list-style-type: none"> • : Random folder • ALL: Random all • (gray): Off

* About playback mode:

- Available playback mode differs depending on the source, file type, connected device, etc.
- You cannot activate repeat playback mode and random playback mode at the same time.

Various Screens and Operations

	Displays other available operation keys besides those shown on . <ul style="list-style-type: none">To hide the window, touch .
[SETUP]	Displays the setting screen of the current playback source.
	Selects a folder.
	Attenuates/restores the sound.
	Displays the folder list/track list/audio menu/video menu.
	<ul style="list-style-type: none">(Touch) Selects an item (chapter/folder/track/audio file/video file).(Hold) Reverses/forwards search.
	Starts/pauses playback.

Playback control by touch operations

You can also control playback by moving your finger on the touch panel as follows (for some sources, the gesture control is not available).

- Sliding the finger towards up/down: Functions same as pressing /.
- Sliding the finger towards left/right: Functions same as pressing /.
- Moving your finger clockwise or counterclockwise: Increases/decreases the volume.

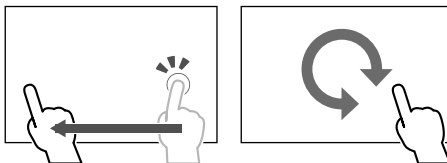

Using the pop-up short-cut menu

While displaying the source control screen, you can jump to another screen by touching the operation keys on the pop-up short-cut menu.

1 Display the pop-up short-cut menu.



2 Select an item to jump.

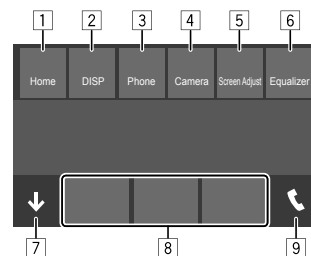

E.g. Pop-up short-cut menu screen

- Displays the Home screen.
- Switches the screen. (Touch)
 - The screen switched to depends on the **<DISP Key>** setting. (Page 32)
 - Turns off the display. (Hold)
- Displays the phone control screen. (Page 23)
- Displays the picture from the connected rear view camera.
- Displays the picture adjustment screen. (Page 10)
- Displays the **<Equalizer>** screen. (Page 28)
- Closes the pop-up short-cut menu.
- Changes the playback source.
 - The three short-cut playback source keys displayed on the Home screen are displayed on the short-cut menu.
- Displays the phone control screen.

Various Screens and Operations

Using touch screen operation during playback

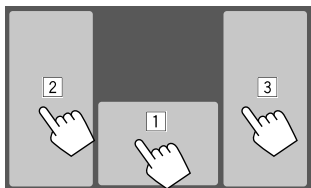

Touching the areas performs the following actions:

- 1 Displays the source control screen.
- 2 Goes to the previous track.*
- 3 Goes to the next track.*

* Not available for video from an external component (AV-IN).

List/setting screen

The followings are the common operation keys which appear on the list/settings screen.

- The appearance of the operation keys may differ, however the similar operation keys have the same operations.
- Available operation keys differ depending on the setting screens. Not all the following operation keys are shown on every screen.

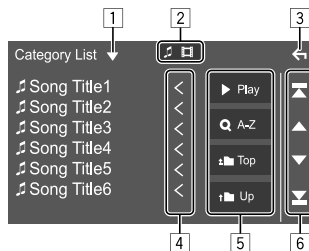

Touching the operation keys performs the following actions:

- 1 Displays list type selection window.
- 2 Selects the file type ([🎵]: audio/[📺]: video).
- 3 Exits from the current screen or returns to the previous screen.
- 4 Scrolls the text if not all of the text is shown.
- 5 Play/search keys
 - [▶ Play]: Plays all tracks in the folder containing the current track.
 - [🔍 A-Z]: Enters alphabet search to list the items in alphabetical order. When a keypad appears, touch the first letter you want to search for.
 - [🏠 Top]: Returns to the root folder.
 - [⬆️ Up]: Returns to the upper layer.
- 6 Changes the page to display more items.
 - [▲]/[▼]: Scrolls the page.
 - [⬆️]/[⬇️]: Jumps to the top or bottom page.

Video

Playback operations

Video playback information on the source control screen

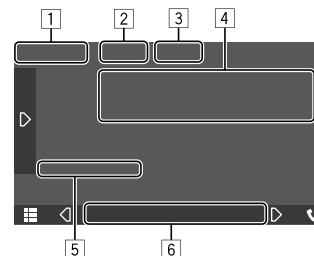

E.g. Video playback source control screen

- 1 Media type
- 2 Hides the operation buttons on the screen.
 - Touch the screen to restore the operation buttons.
- 3 Repeat/random playback mode keys
- 4 Current playback item information/audio format
- 5 Playback status/playing time
- 6 Indicators
 - **VIDEO**: Lights up when video is played.

Video

■ Adjusting the picture

1 Display the pop-up short-cut menu.



2 Display the picture adjustment screen.

On the pop-up short-cut menu, touch as follows:

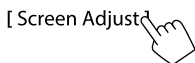

3 Adjust the picture.

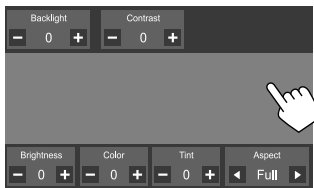

<Backlight>	Adjusts the brightness of the backlight. (-4 to +4)
<Contrast>	Adjusts the contrast. (-4 to +4)
<Brightness>	Adjusts the brightness. (-4 to +4)
<Color>*1	Adjusts the color. (-4 to +4)
<Tint>*2	Adjusts the tint. (-4 to +4)
<Aspect>	Selects the aspect ratio. <ul style="list-style-type: none">• Full: Changes the aspect ratio of video and displays fully on the screen.• Normal: Displays the video in the aspect ratio of 4:3.• Auto*3: Displays the video fully on vertical or horizontal with no ratio change.

- Adjustable items are different depending on the current source.
- You can perform this function only when you have applied the parking brake.

*1 Adjustable only during playback.

*2 Available only when the "AV-IN" or camera screen is displayed.

*3 Selectable only when video from a USB device is played back.

USB

You can connect a USB mass storage class device such as a USB memory, digital audio player, etc. to the unit.

- For playable file types and other information, see page 40.
- You cannot connect a PC or portable HDD to the USB input terminal.
- You cannot connect a USB device via a USB hub.

Connecting a USB device

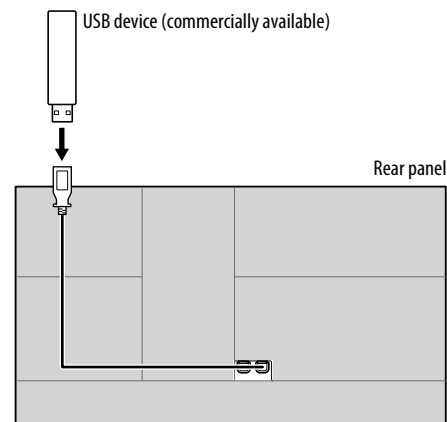

Playback operations

■ Playback information and key operation

- For playback information, see “Source control screen” on page 7.
- For key operations on the touch panel, see “Common operation keys on source control screen” on page 7.
- All tracks in the USB device will be played repeatedly until you change the source or disconnect the USB device.

■ Selecting a folder/track on the list

1 Display the folder/track list.

On the source control screen, touch as follows:



2 Select the list type.



3 Select the desired track.

- Repeat the procedure until you select the desired track.
- For details about the list operation, see page 9.

From <Category List>:

- ① Select the file type ([🎵]: audio/[📺]: video).
- ② Select a category, then the item in the selected category.

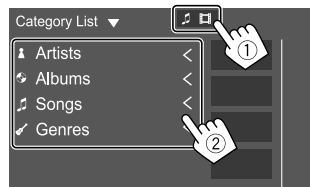

From <Link Search>:

- ① Select the file type ([🎵]: audio/[📺]: video).
- ② Select the tag type to display a list of contents that contains the same tag as the track/file currently being played, then select the item.

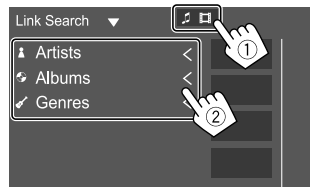

From <Folder List>:

Select the folder, then the item in the selected folder.



iPod/iPhone

Connecting an iPod/iPhone

- For playable iPod/iPhone types and other information, see page 41.
- You cannot watch video.

Wired connection

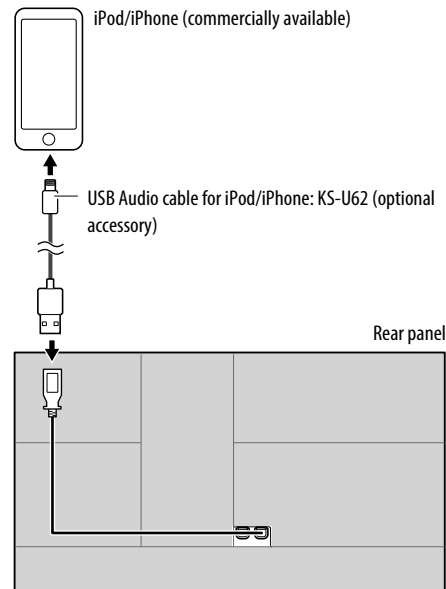

Bluetooth connection

Pair the iPod/iPhone with this unit via Bluetooth.
(Page 20)

Playback operations

■ Playback information and key operation

- For playback information, see “Source control screen” on page 7.
- For key operations on the touch panel, see “Common operation keys on source control screen” on page 7.

■ Selecting an audio file from the menu

1 Display the list.

On the source control screen, touch as follows:



2 Select the list type.



3 Select the desired track.

- Repeat the procedure until you select the desired track.
- For details about the list operation, see page 9.

From <Category List>:

Select a category, then the item in the selected category.

- Available categories differ depending on the type of iPod/iPhone.

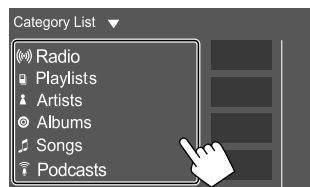

From <Link Search>:

Select the tag type to display a list of contents that contain the same tag as the track/file currently being played, then select the item.

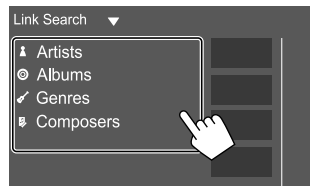

Apps—WebLink™

You can display and control the App on the unit while your smartphone is connected to the USB input terminal.

Preparation: Be sure to ground the PRK SW lead. (Page 39)

Available Apps

You can use the following Apps on this unit. Install the WebLink™ App on your smartphone beforehand.

WebLink™

WebLink™ enables you to use the following Apps with the unit.

- Media Player
- Yelp
- YouTube
- OpenWeatherMap

Connecting a smartphone

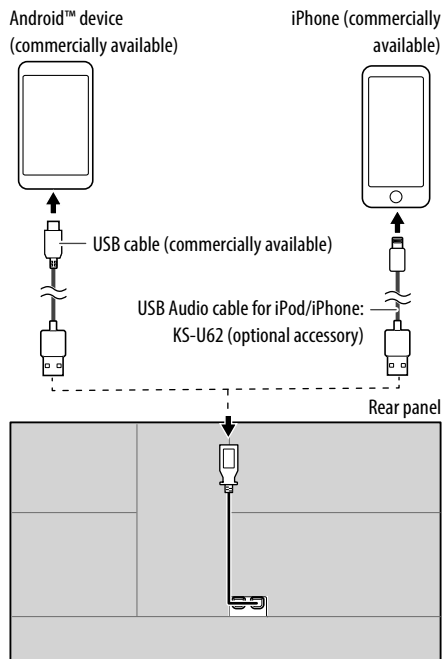

- When the smartphone is connected to the unit and “WebLink” is selected as the source, a confirmation message to communicate with each other appears on the smartphone. Touch **[Allow]** to establish connection, or **[Ignore]** to cancel the connection.
- You can check the connection status on the WebLink™ screen on your smartphone.

Start playback

1 Select “WebLink” as the source.

2 Operate on the unit to select App.

- On the “WebLink” source screen, you can also operate on the touch panel as follows:



- Displays the main menu of the “WebLink” source screen.
- Exits the current App.



- Returns to the previous screen.
- Exits the current App.

3 Operate on your smartphone.

- When you are asked to communicate between your smartphone and the unit, touch **[Allow]** to proceed.
- If App does not start while using “WebLink”, start the App on your smartphone.

Switching to the App screen while listening to the another source

You can display the App screen while listening to the other source.

- Set <DISP Key> to **[App]** on the <User Interface> screen beforehand. (Page 32)

1 Display the pop-up short-cut menu.



2 Switch to the App screen.

On the pop-up short-cut menu, touch as follows:



- Each time you touch the key, the screen switches between the current source and App screen.

Tuner

Listening to the radio

■ Playback information on the source control screen

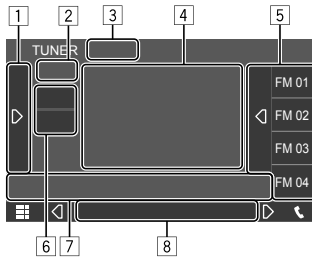

E.g. Tuner source control screen

- 1 Displays/hides other available operation keys*
- 2 Preset no.
- 3 Changes the seek mode for [◀◀]/[▶▶]
 - **AUTO1** (Initial): Auto search
 - **AUTO2**: Tunes in preset stations one after another
 - **MANUAL**: Manual search
- 4 Text information
 - Touching [◀] scrolls the text if not all of the text is shown.
 - Touching [⊞] switches the information (e.g. frequency, PS name, Radio Text, title, artist, etc.).
 - The availability of the information vary depending on the reception, selected station.

- 5 Preset list
- 6 Selects the band (AM/FM)
- 7 Operation keys*
- 8 Indicators

- **TI**: Lights up in white when receiving the traffic information, and lights in orange when being standby for Traffic Information Reception.
- **ST**: Lights up when receiving stereo broadcast.
- **MONO**: Lights up when receiving stations in monaural forcibly.
- **AF**: Lights up when the Network-Tracking Reception is activated.
- **EON**: Lights up when a Radio Data System station is sending EON signals.
- **LO.S**: Lights up when Local Seek is activated.
- **NEWS**: Lights up when News Standby Reception is activated.
- **RDS**: Indicates the status of the Radio Data System station reception when the Network-Tracking Reception is activated. (Page 16)
 - Lights in white: Radio Data System station is being received.
 - Lights in orange: Radio data System station is not being received.

* See the following "Operation keys on source control screen".

Operation keys on source control screen

- The appearance of the operation keys may differ, however the similar operation keys have the same operations.
- See also "Common operation keys on source control screen" on page 7.

Touching the operation keys performs the following actions:

1

- [TI]*1 (For FM Radio Data System features)
Activates TI standby reception mode.
- When TI is activated, the unit is ready to switch to traffic information if available. The TI indicator lights up in white.
 - If the TI indicator lights up in orange, tune into a station providing Radio Data System signals.
 - The volume adjustment for traffic information is automatically memorized. The next time the unit switches to traffic information, the volume is set to the memorized level.
 - To deactivate, touch [TI] again.

[SSM]*1 Presets stations automatically.

- [MONO]*1 Activates monaural mode for better FM reception (stereo effect will be lost).
- The MONO indicator lights up while monaural mode is activated.
 - To deactivate, touch [MONO] again.

Tuner

[SETUP]*1 Displays the <TUNER SETUP> screen.

[PTY]*1*2 (For FM Radio Data System features)
Enters PTY search mode.

① Touch a PTY code.

② Touch [Search] to search for.

If there is a station broadcasting a program of the same PTY code as you have selected, that station is tuned in.

- You can set the language displayed for the PTY Search on the <TUNER SETUP> screen. (Page 16)

[LO.S]*1 You can tune in FM stations only with strong signals—Local Seek.

- ON:** Tunes in only to FM stations with sufficient signal strength. The LO.S indicator lights up.
- OFF (Initial):** Deactivates the function.

[7]

[◀◀]/[▶▶] Searches for a station.

- The search method differs according to the selected seek mode.

*1 Appears only when FM is selected as the source.

*2 Only British English/Espanol/Francais/Nederlands/Norsk/Portugues/Svenska/Deutsch are available for the text language here. If another language has been selected in <Language> (Page 4), the text language is set to English.

Storing preset stations in the memory

You can preset 15 stations for FM and 5 stations for AM.

Automatic presetting — SSM (Strong-station Sequential Memory) (for FM only)

On the source control screen, touch as follows:

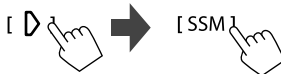

A confirmation message appears. Touch [Yes].

The local stations with the strongest signals are found and stored automatically.

Manual presetting

1 Select the band, then tune in to a station you want to store.

- See "Playback information on the source control screen" on page 14 for details.

2 Display the preset list.

On the source control screen, touch as follows:



3 Select a preset number to store into.

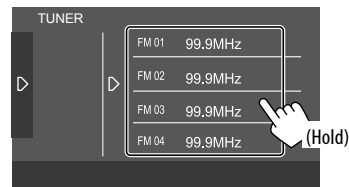

The station selected in step 1 is stored into the preset number you have selected.

To hide the preset list: Touch [D] on the preset list.

Selecting a preset station

1 Select the band, then display the preset station list.

On the source control screen, touch as follows:



2 Select a preset station.

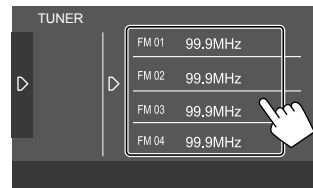

To hide the preset list: Touch [D] on the preset list.

Settings for tuner reception

1 Display the <TUNER SETUP> screen.

On the source control screen, touch as follows:



2 Make the settings.

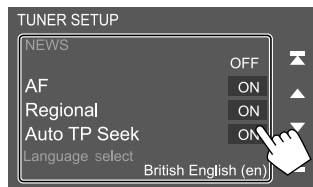

[NEWS]*1

- **00min to 90min:** Activates New Standby Reception by selecting the period of time to disable the interruption. The NEWS indicator lights up.
- **OFF** (Initial): Deactivates the function.

[AF]

When driving in an area where FM reception is not sufficient enough, this unit automatically tunes in to another FM Radio Data System station of the same network with stronger signals— Network-Tracking Reception (AF: Alternative Frequencies).

- **ON** (Initial): Switches to another station. The program may differ from the one currently received.*2
- **OFF:** Deactivates the function.

[Regional]

When driving in an area where FM reception is not sufficient enough, this unit automatically tunes in to another FM Radio Data System station of the same program with stronger signals— Network-Tracking Reception (Regional).

- **ON** (Initial): Switches to another station broadcasting the same program.*2
- **OFF:** Deactivates the function.

[Auto TP Seek]

When traffic information station reception is poor, the unit automatically searches for another station that can be received better—Auto TP Seek.

- **ON** (Initial): Automatically searches for a station with better reception for traffic information if the current reception of current station is poor.
- **OFF:** Deactivates the function.

[Language Select]

Select the language to display for PTY search.

- **British English** (Initial)/**Espanol/Francais/Nederlands/Norsk/Portugues/Svenska/Deutsch**

To close the setting window, touch **[Close]**.

- *1 The volume adjustment for Traffic Information is automatically memorized. The next time the unit switches to Traffic Information, the volume is set to the previous level.
- *2 The RDS indicator lights up when the Network-Tracking Reception is activated.
 - Lights in white: Radio Data System station is being received.
 - Lights in orange: Radio data System station is not being received.

Spotify

With Spotify, your music is everywhere. Working out, partying or relaxing, the right music is always at your fingertips. There are millions of songs on Spotify—from old favorites to the latest hits. Just choose the music you love, or let Spotify surprise you.

You can stream Spotify from iPhone/iPod touch or Android devices.

- Because Spotify is a third-party service, the specifications are subject to change without prior notice. Accordingly, compatibility may be impaired or some or all of the services may become unavailable.
- Some functions of Spotify cannot be operated from this unit.
- For issues using the application, contact Spotify at <www.spotify.com>.

Preparation

■ Installing the application

Your smartphone must have built-in Bluetooth and the following profiles must be supported:

- SPP (Serial Port Profile)
- A2DP (Advanced Audio Distribution Profile)

Establish an Internet connection using LTE, 3G, EDGE, or Wi-Fi.

Ensure you are logged in to your smartphone application. If you do not have a Spotify account, you can create one for free from your smartphone or at <www.spotify.com>.

Install the latest version of the Spotify application on your smartphone.

- For Android devices: Search for “Spotify” in Google Play to find and install the most recent version.
- For iPhone/iPod touch: Search for “Spotify” in the Apple iTunes App Store to find and install the most recent version.

■ Connecting the device

For Android devices

Pair the Android device with this unit via Bluetooth. (Page 20)

For iPhone/iPod touch

- Via USB input terminal: Connect iPhone/iPod touch with the cable KS-U62 (optional accessory). (Page 11)
- Via Bluetooth: Pair the iPhone/iPod touch with this unit. (Page 20)

Playback operations

■ Playback information and key operation

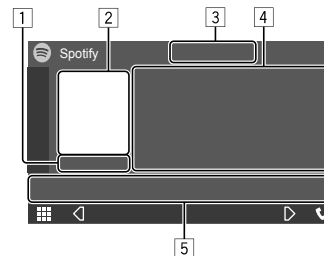

E.g. Spotify source control screen

You can also operate Spotify with an optionally purchased remote controller, RM-RK258. You can only control play, pause and skip with the remote controller.

- 1 Playing time
- 2 Picture data
- 3 Thumb up/down and repeat/shuffle playback mode keys*
- 4 Track information
 - Touching [◀] scrolls the text if not all of the text is shown.
- 5 Operation keys*

* See “Operation keys on source control screen” on page 18.

Operation keys on source control screen

- The appearance of the operation keys may differ, however the similar operation keys have the same operations.
- See also “Common operation keys on source control screen” on page 7.

Touching the operation keys performs the following actions:

[]*1	Thumbs down to the current track and skips to the next track.
[]*1	Registers the current track as a favorite.
[]*2 *3	Activates () /deactivates () shuffle playback mode.
[]*2	Selects repeat playback mode (: repeat one*3/ALL: repeat all/: repeat off).

[]	Displays the Spotify menu screen.
[]	Creates a new station (Start Radio).
[]*2 *3 []	Selects a track.
[]	Starts () /pauses () playback.
[]	Saves the current track/artist/album to <Your Music> or <Your Library>.

*1 Not available for tracks in a playlist.

*2 Not available for tracks in the Radio.

*3 Available only for premium account users.

■ Creating your station (Start Radio)

Start Radio is to start a radio channel based on the currently played track.

Create your station.

On the source control screen, touch as follows:



Station is created and playback starts automatically.

- You can personalize your station using thumb up () or thumb down ()
– Personalizing stations may not be available depending on the track.

■ Selecting a track

1 Display the Spotify menu screen.

On the source control screen, touch as follows:

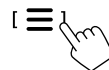

2 Select the list type, then select a desired item.

- The list types displayed differ depending on the information sent from Spotify.



Other External Components

Rear view camera

Install the rear view camera (separately purchased) in the appropriate position according to the instructions supplied with the rear view camera.

■ Connecting a rear view camera

See page 38 for more information for connection terminals.

- To use the rear view camera, a reverse lead (REVERSE) connection is required. (Page 39)

■ Using the rear view camera

- For rear view camera settings, see “Camera settings” on page 32.

To display the rear view camera screen

The rear view camera screen is displayed by shifting the gear to the reverse (R) position when **[R-CAM Interruption]** is set to **[ON]** on the **<Camera>** screen. (Page 32)

- A caution message appears on the screen. To remove the caution message, touch the screen.

You can also display the picture from the rear view camera manually without shifting the gear to the reverse (R) position.

1 Display the pop-up short-cut menu.



2 Display the rear view camera screen.

On the pop-up short-cut menu, touch as follows:



To exit the camera screen

Touch the area shown below.



AV-IN

■ Connecting an external component

See page 38 for connection terminals.

■ Starting playback

1 Select “AV-IN” as the source.

On the Home screen, touch as follows:

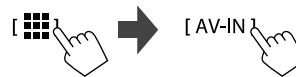

2 Turn on the connected component and start playing the source.

- For playback information, see “Source control screen” on page 7.

Information

Bluetooth is a short-range wireless radio communication technology for mobile devices such as mobile phones, portable PCs and other devices. Bluetooth devices can be connected without cables and communicate with each other.

Note

- While driving, do not perform complicated operations such as dialing numbers, using the phonebook, etc. When you perform these operations, stop your car in a safe place.
- Some Bluetooth devices may not connect to this unit depending on the Bluetooth version of the device.
- This unit may not work for some Bluetooth devices.
- Connecting conditions may vary depending on your environment.
- For some Bluetooth devices, the device is disconnected when the unit is turned off.
- If your mobile phone supports PBAP (Phone Book Access Profile), you can display the following items on the touch panel when the mobile phone is connected.
 - Phonebook: up to 1 000 entries
 - Dialed calls, received calls, and missed calls (up to 50 entries in total)

Preparation

- Connect and install the microphone beforehand. For details, see page 39.
- Set **[Bluetooth]** to **[ON]** on the **<Bluetooth>** screen. (Page 34)

Connection

When you connect a Bluetooth device to the unit for the first time:

- ① Register the device by pairing the unit and the device.
- ② Connect the device to the unit. (Page 21)

■ Registering a new Bluetooth device

Pairing allows Bluetooth devices to communicate with each other.

- The pairing method differs depending on the Bluetooth version of the device.
 - For devices with Bluetooth 2.1:
You can pair the device and the unit using SSP (Secure Simple Pairing) which only requires confirmation.
 - For devices with Bluetooth 2.0:
You need to enter a PIN code both on the device and the unit for pairing.
- Once connection is established, it is registered in the unit even if you reset the unit. Up to 10 devices can be registered in total.
- Two Bluetooth devices for Bluetooth phone and one for Bluetooth audio can be connected at a time.
- To use the Bluetooth function, you need to turn on the Bluetooth function of the device.

Auto pairing

When **<Auto Pairing>** is set to **[ON]** on the **<TEL SETUP>** screen, iOS (such as iPhone) devices are automatically paired when connected via USB. (Page 26)

Registering a Bluetooth device

1 Search for the unit (“KW-M5”) from your Bluetooth device and operate the device to register.

For a Bluetooth device compatible with SSP (Bluetooth 2.1):

Confirm the request both on the device and the unit.

On the device:



On the unit:

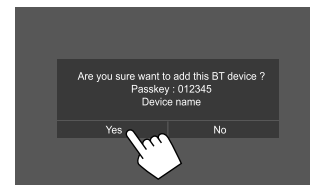

- Touch **[No]** to reject the request.

For a Bluetooth device compatible with Bluetooth 2.0:

Select the unit ("KW-M5") on your Bluetooth device.

- If a PIN code is required, enter the PIN code shown on the screen (initial: "0000").

To change PIN code, see page 22.

2 Determine usage as a hands free device (①), then touch [Close] (②).

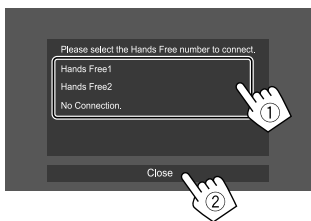

**[Hands Free1]/
[Hands Free2]** Select hands free number to use as the hands free device.

[No Connection.] Select this when you do not want to use as the hands free device.

3 When your Bluetooth device is compatible with A2DP or SPP: Determine usage as an audio player or a device with Apps installed.

[Yes] Select to use the device as an audio player.

[No] Select this when you do not want to use the Bluetooth device as an audio player.

4 When your Bluetooth device is compatible with PBAP: Select whether to transfer the phonebook of your Bluetooth device to the unit or not.

[Yes] Select to transfer the phonebook from your Bluetooth device.

[No] Select this when you do not want to transfer the phonebook.

■ Connecting/disconnecting a registered Bluetooth device

1 Display the <Select Device> screen.

On the Home screen, touch as follows:



Then, on the <SETUP> screen, touch **[Bluetooth]**.

On the <Bluetooth Setup> screen, touch **[Select Device]**.

2 Select the device you want to connect/disconnect.

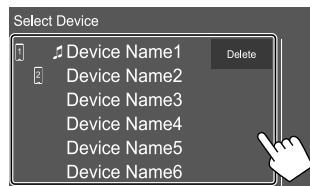

The icons beside the registered device indicate the following:

- : Connected as a mobile phone.
- : Connected as an audio player.

3 Select the usage of the device (①), then touch [Close] (②).

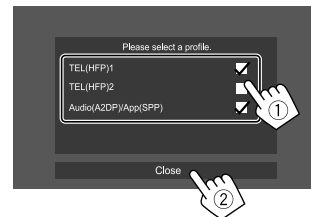

Each time you touch the selection, the usage is selected ("✓" appears) or deselected ("✓" disappears). Select to connect and deselect to disconnect the device.

**[TEL (HFP)1]/
[TEL (HFP)2]** Select to use as the hands free device.

**[Audio (A2DP)/
App (SPP)]** Select to use as the audio player or device with Apps installed.

To delete the registered Bluetooth device: Touch **[Delete]** in step 2, select devices to delete, then touch **[Delete]**. A confirmation message appears. Touch **[Yes]**.

- To select all devices, touch **All**.
- To deselect all selected devices, touch **All**.

■ Changing the PIN code

1 Display the <Change PIN Code> screen.

On the Home screen, touch as follows:



Then, on the <SETUP> screen, touch [Bluetooth].

On the <Bluetooth Setup> screen, touch [PIN Code].

2 Enter the PIN code (①), then confirm the entry (②).

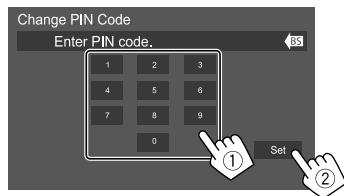

- To clear the last entry, touch [BS].

■ Changing the device name of the unit displayed on the paired device

1 Display the <Change Device Name> screen.

On the Home screen, touch as follows:



Then, on the <SETUP> screen, touch [Bluetooth].

On the <Bluetooth Setup> screen, touch [Device Name].

2 Enter the device name (①), then confirm the entry (②).



- To clear the last entry, touch [BS].
- To move the entry position, touch [◀/▶].

Bluetooth mobile phone

■ When a call comes in...

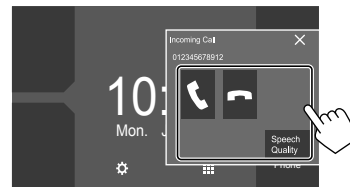

Touching the operation keys performs the following actions:



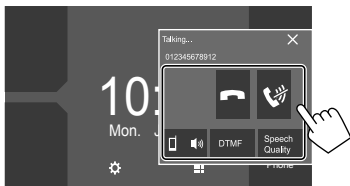

[☎]	Answers a call.
[📞]	Rejects a call.
[Speech Quality]	Displays the <Speech Quality adjust> screen. <ul style="list-style-type: none"> • Microphone Level: Adjusts the microphone volume level. (-10 to 10, initial: 0) • Echo Cancel Level: Adjusts the echo volume level. (OFF, -5 to 5, Initial: 0) • Noise Reduction Level: Adjusts the noise reduction volume. (OFF, -5 to 5, Initial: 0)

- Call information is displayed if acquired.
- Phone operation is not available while the picture from the rear view camera is displayed.

■ During a call...



Touching the operation keys performs the following actions:

[]	Ends a call.
[]	Mutes the volume of the microphone.
[] / []	Switches between hands free mode and phone mode.
[DTMF]	Enters DTMF (Dual Tone Multi Frequency), then sends text using the keypad.
[Speech Quality]	Displays the <Speech Quality adjust> screen. • See page 22 for details.

■ Making a call

1 Display the phone control screen.

On the Home screen, touch as follows:

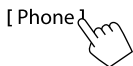

2 Select a method to make a call.

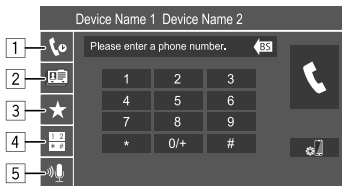

- 1 From the call history* (missed calls/received calls/dialed calls)
- 2 From the phonebook*
- 3 From the preset list (Page 24)
- 4 Use direct number entry
- 5 Use voice dialing

3 Select a contact to make a call.

Ⓐ When item 1, 2 or 3 is selected in step 2:

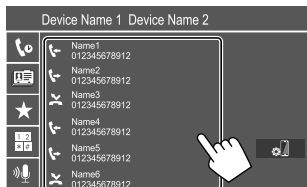

- If the selected contact has several phone numbers, the phone number list is displayed. Select a phone number to make a call.

To use alphabet search in the phonebook

- ① Touch [**Q A-Z**].
 - ② Touch the first letter you want to search for on the keypad.
To search for a number, touch [1].
 - ③ Select a contact you want to call from the list.
- You can select a first name or last name to use when sorting the list in alphabetical order on the <TEL SETUP> screen. (Page 26)

Ⓑ When item 4 is selected in step 2:

Enter the phone number (①), then make a call (②).

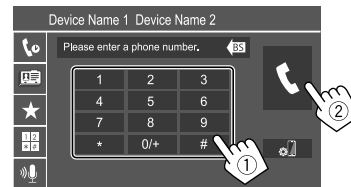

- To enter "+", touch and hold [0/+].
- To clear the last entry, touch [BS].

* Applicable only for mobile phone compatible with PBAP (Phone Book Access Profile).

© When item 5 is selected in step 2:

Say the name of the person you want to call.

- You can also make voice dialing by pressing and holding the **FNC** on the monitor panel.
- Available only when the connected mobile phone has a voice recognition system.
- If the unit cannot find the target, "Press [Restart] to restart the voice recognition process." appears. Touch **[Restart]**, then say the name again.
- To cancel voice dialing, touch **[Stop]**.

■ Switching between two connected devices

You can change the device to use when two devices are connected.

On the phone control screen:

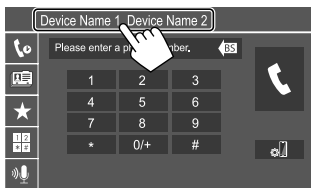

The active device is highlighted.

■ Presetting phone numbers

You can preset up to eight phone numbers.

1 Display the <Edit Preset Dial> screen.

On the Home screen, touch as follows:

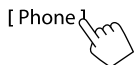

Then, on the phone control screen, touch as follows:

[★] → [Edit]

2 Select a position to store into.

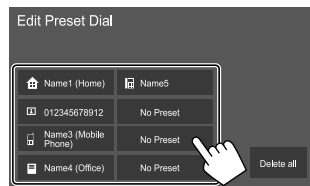

3 Select a method to add a phone number to preset list and register the number to the preset list (1), then touch [Close] (2).

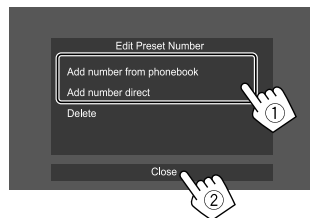

[Add number from phonebook]	Select a phone number from the phonebook.
[Add number direct]	Enter a phone number on the direct number entry screen, then touch [Set] to add to the preset list.

- To display the preset list, touch [★] on the phone control screen.

To delete a phone number from the preset list:

Select the phone number to delete on the **<Edit Preset Dial>** screen, then touch **[Delete]** in step 3.

To delete all phone numbers from the preset list:

Touch **[Delete all]** on the **<Edit Preset Dial>** screen in step 2.

■ Editing phonebook

To transfer the phonebook

If the connected Bluetooth mobile phone is compatible with Phone Book Access Profile (PBAP), you can transfer the phonebook of the mobile phone to the unit.

1 Display the phone control screen.

On the Home screen, touch as follows:

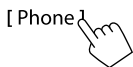

2 Start phonebook data transmission.

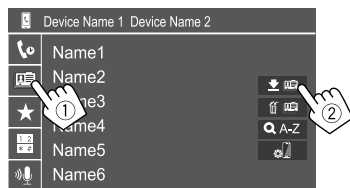

To delete contact from the phonebook: Touch [🗑️] in step 2 (2), select devices to delete, then touch [Delete]. A confirmation message appears. Touch [Yes].

- To select all devices, touch [All].
- To deselect all selected devices, touch [All].
- Touch [Q A-Z] to search the contact by initial.

Bluetooth audio player

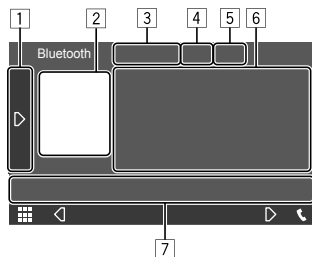

E.g. Bluetooth source control screen

- 1 Displays/hides other available operation keys*1
- 2 Artwork (Shown if the track contains artwork)
- 3 Connected device name
- 4 Repeat/random playback mode keys*1
- 5 Signal strength and battery level (Appears only when the information is acquired from the device.)
- 6 Tag data*2 (current track title/artist name/album title)
 - Pressing [←] scrolls the text if not all of the text is shown.
- 7 Operation keys*1

*1 See “Common operation keys on source control screen” on page 7.

*2 Available only for devices compatible with AVRCP 1.3.

■ Playback information and key operation

- For playback information, see “Source control screen” on page 7.
- For key operations on the touch panel, see “Common operation keys on source control screen” on page 7.

Additional keys operations: Touching the operation keys performs the following actions.

[BT DEVICE CHANGE] Switches to another Bluetooth audio player.

■ Selecting a track from the list

1 Display the music list.

On the source control screen, touch as follows:



2 Select the folder, then the item in the selected folder.

- For details about the list operation, see page 9.



Bluetooth mobile phone settings

You can change various settings for using Bluetooth mobile phones on the <TEL SETUP> screen.

1 Display the <TEL SETUP> screen.

On the Home screen, touch as follows:



Then, on the <SETUP> screen, touch [Bluetooth].

On the <Bluetooth Setup> screen, touch [TEL SETUP].

2 Make the settings.

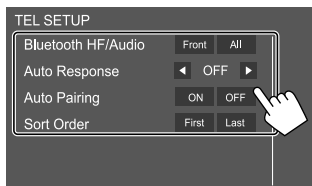

<Bluetooth HF/Audio>

Select the speakers used for Bluetooth mobile phones.

- **Front:** Front speakers only.
- **All (Initial):** All speakers.

<Auto Response>

- **1 – 30** (in 5 second steps): The unit answers the incoming calls automatically. Set the calling ring time (seconds).
- **OFF (Initial):** The unit does not answer the calls automatically. Answer the calls manually.

<Auto Pairing>

- **ON (Initial):** Establishes pairing automatically with the iOS device (such as iPhone) connected via USB. (Auto pairing may not work for some devices depending on the iOS version.)
- **OFF:** Cancels.

<Sort Order>

Select a first name or last name to use when sorting the list in alphabetical order.

- **First:** Sorts the list in the order of first name.
- **Last (Initial):** Sorts the list in the order of last name.

Settings

Audio settings

1 Display the <Audio> screen.

On the Home screen, touch as follows:



2 Select a setting to change.

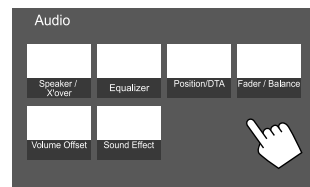

E.g. Audio settings screen

You cannot change the <Audio> screen in the following situations:

- When the AV source is turned off.
- When the Bluetooth phone is used (making or receiving a call, during a call, or while voice dialing).

<Speaker/X'over>

Preparation:

Before making the adjustment for <Speaker/X'over>, select the appropriate crossover network mode according to the speaker system (2-way speaker system or 3-way speaker system).

1 Turn off the AV source.

On the Home screen, touch as follows:



Then, on the source/option selection screen, touch [AV Off].

2 Display the <X'over Network> screen.

On the monitor panel, press the following buttons at the same time:

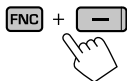

3 Select the crossover network mode.

[2way] Select this when 2-way system speakers are used (front/rear).

[3way] Select this when 3-way system speakers are used (tweeter/mid range/woofer).

A confirmation message appears. Touch [Yes].

Setting the speakers and crossover frequency

1 Select a car type (①), select a speaker (②) (front speakers, rear speakers, or subwoofer) to set, then location* and speaker/tweeter size (③) of the selected speaker.

A selection window appears for each setting. Select an item, then touch [Close] to close the window.

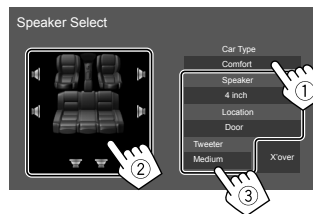

- Repeat steps ② and ③ to set all speakers.
- Adjustable items vary depending on the selected speaker type.
- When a speaker is not connected, select [None].
- When setting the front speakers, also select the speaker size for <Tweeter>.

2 Touch [X'over] to display the <X'over> screen.

3 Select the speaker type (①), then adjust the crossover frequency (②) of the selected speaker.



- Adjustable items vary depending on the selected speaker type/speaker size/crossover settings.

<HPF FREQ>

Adjusts the crossover frequency for the front or rear speakers (high pass filter).

<LPF FREQ>

Adjusts the crossover frequency for the speaker (low pass filter).

<Slope>

Adjusts the crossover slope.

<Gain>

Adjusts the output volume of the selected speaker.

<TW Gain>

Adjusts the output volume of the tweeter.

<Phase Inversion>

Selects the phase for the speaker.

* Speaker location selection is available only when <X'over Network> is set to [2way].

Settings

<Equalizer>

The following adjustments are memorized for each source until you adjust the sound again. You cannot adjust the sound when the unit is in standby.

■ Selecting a preset sound mode

1 Display the preset sound modes.

[Preset Select] 

2 Select a preset sound mode.

- Pop/Hip Hop/R&B/Jazz/Classical/Hard Rock/Flat (Initial)/iPod/User1/User2/User3/User4

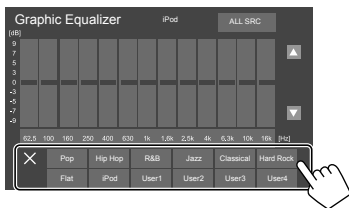

To hide the preset sound modes: Touch [**X**].

■ Store your own sound adjustments

1 Select a preset sound mode.

2 Select a band (①) and adjust the level (②), then adjust the sound (③).

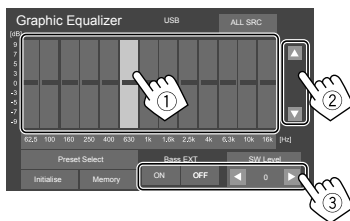

Adjust the sound as follows:

<Bass EXT>

Activates/deactivates bass.

- ON/OFF (Initial)

<SW LEVEL>

Adjusts the subwoofer level.*

- -50 to +10 (Initial: 0)

3 Repeat step 2 to adjust the level of other bands.

4 Touch [Memory] to store adjustment.

A user selection window appears. Select from [User1] to [User4] to store your adjustment, then touch [Close] to close the window.

- To apply the adjusted equalizer to all playback source, touch [ALL SRC], then touch [OK] to confirm.
- To clear the adjustment, touch [Initialise].

* Not adjustable when <None> is selected for subwoofer on the <Speaker Select> screen. (Page 27)

<Position/DTA>

You can adjust the sound effects according to your listening position. You can also localize the sound image in front of the selected seat.

■ Setting the listening position

Touch [Listening Position] (①), then select the listening position ([Front L], [Front R], [Front All]*, or [All]) (②).

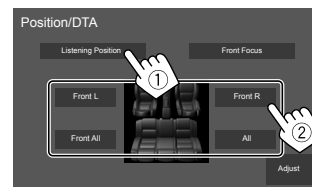

* [Front All] is selectable only when <X'over Network> is set to [2way].

Settings

■ Adjusting the Digital Time Alignment (DTA)

Make fine adjustments to the delay time of the speaker output to create a more suitable environment for your car.

1 Touch [Adjust] on the <Position/DTA> screen to display the DTA adjustment screen.

2 Touch [Delay] (①), then adjust the Digital Time Alignment (DTA) value (②) for each speaker.

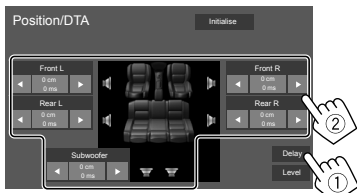

- To determine the adjustment value, see “Determining the value for <Position/DTA> adjustment” on page 30.

3 Touch [Level] (①), then adjust the output volume (②) for each speaker.

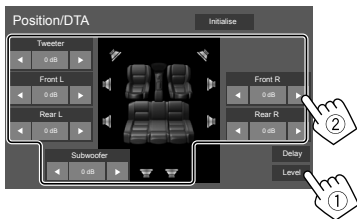

To initialize the setting value: Touch [Initialise].

■ Localizing the sound image—Front Focus

1 Touch [Front Focus] (①), select the listening position (②) to set as the front position, then touch [Adjust] (③).

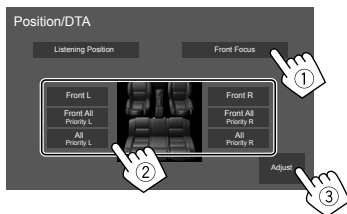

- When you are sitting on the [Front All] (front seats) or [All] (front and rear seats) position, select left (“Priority L”) or right (“Priority R”) to specify the position to localize the sound image.

2 Touch [Delay] (①), then adjust the sound image (②) precisely.

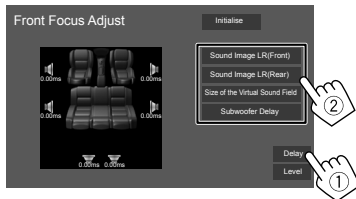

[Sound Image LR (Front)]

Adjusts the sound image to be localized set on the front position.

[Sound Image LR (Rear)]

Adjusts the sound image to be localized set on the rear position.

[Size of the Virtual Sound Field]

Adjusts the virtual sound field to the desired field size.

- If the sound image moves out of the front position, adjust [Sound Image LR (Front)]/[Sound Image LR (Rear)].

[Subwoofer Delay]

Adjusts the delay time of the subwoofer sound.

3 Touch [Level] (①), then adjust the output volume (②) for each speaker.

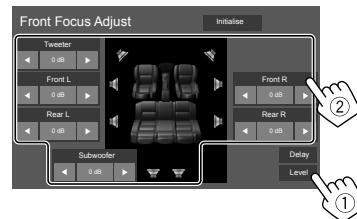

To initialize the setting value: Touch [Initialise].

Determining the value for <Position/DTA> adjustment

If you specify the distance from the center of the currently set listening position to every speaker, the delay time will be automatically computed and set.

- ① Determine the center of the currently set listening position as the reference point.
- ② Measure the distances from the reference point to the speakers.
- ③ Calculate the differences between the distance of the furthest speaker and other speakers.
- ④ Set the DTA value calculated in step ③ for individual speakers.
- ⑤ Adjust gain for individual speakers.

E.g. When **[Front All]** is selected as the listening position

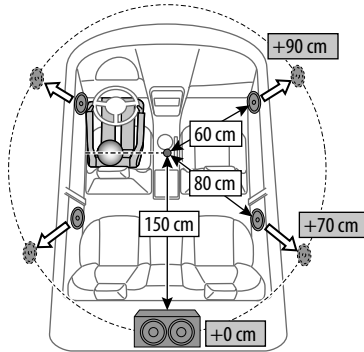

<Fader/Balance>

Touch [▲]/[▼]/[◀]/[▶] or drag the mark to adjust.

<Fader>

Adjusts the front and rear speaker output balance.

When using a two-speaker system, set the fader to the center (0).

- **F15 to R15** (Initial: 0)

<Balance>

Adjusts the left and right speaker output balance.

- **L15 to R15** (Initial: 0)

To clear the adjustment: Touch [Center].

<Volume Offset>

Adjust and store the auto-adjustment volume level for each source. The volume level will automatically increase or decrease when you change the source.

If you have increased the volume first, then reduced the volume using the Volume Offset, the sound generated if you suddenly switch to another source may be extremely loud.

- **-5 to +5** (Initial: 0)

To initialize the setting value: Touch [Initialise].

<Sound Effect>

Adjust the sound effect.

<Bass Boost>

Selects the bass boost level.

- **OFF** (Initial)/1/2/3

<Loudness>

Adjusts loudness. (The LOUD indicator lights up when the loudness is adjusted.)

- **OFF** (Initial)/Low/High

<Volume Link EQ>

Reduces the driving noise by raising the bandwidth.

- **OFF** (Initial)/ON

<Space Enhancement>*

Virtually enhances the sound space using the Digital Signal Processor (DSP) system. Select the enhance level.

- **OFF** (Initial)/Small/Medium/Large

<Digital Track Expander>

Restores the sound lost due to audio compression to a realistic sound.

- **OFF/ON** (Initial)

<Sound Response>

Virtually makes the sound more realistic using the Digital Signal Processor (DSP) system. Select the sound level.

- **OFF** (Initial)/1/2/3

<Sound Lift>

Moves the localization of the sound image to the lower or higher point. Select the height.

- **OFF** (Initial)/Low/Middle/High

* You cannot change the setting when "Tuner" is selected as the source.

Settings

Display settings

Display the <Display> screen.

On the Home screen, touch as follows:



Then, on the <SETUP> screen, touch [Display].

<Dimmer>

- **ON:** Activates dimmer.
- **OFF:** Deactivates dimmer.
- **SYNC (Initial):** Dims the screen and button illumination when you turn on the headlights.

<OSD Clock>

- **ON (Initial):** Displays the clock while a video source is playing.
- **OFF:** Cancels.

<Background>

You can change the background design.

To change the background design:

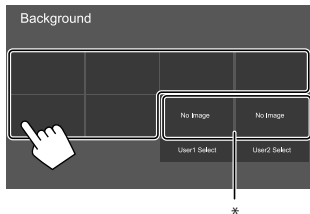

* Selects a loaded favorite image in advance.

■ Storing your favorite image for the background

You can use your favorite image stored on the connected USB device for the background.

- Connect the USB device on which the image is stored beforehand.
- Use a JPEG/PNG/BMP file with a resolution of 800 x 480 pixels.

- 1 Touch [User1 Select] or [User2 Select] to store the image for the <Background> screen.

- 2 Select the folder, then the file for the background image in the selected folder.

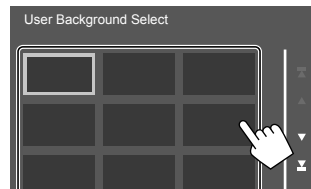

- 3 Rotate the image (①) if necessary, then confirm the selection (②).

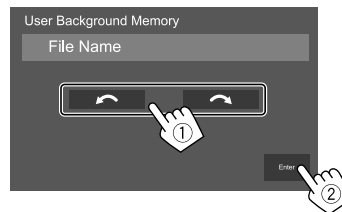

A confirmation message appears. Touch [Enter] to store the new image. (The existing image is replaced with the new one.)

<Viewing Angle>

Select the viewing angle in relation to the monitor to make the image on the screen easier to see.

- **0 (Initial)/-1/-2/-3**

Settings

User interface settings

Display the <User Interface> screen.

On the Home screen, touch as follows:



Then, on the <SETUP> screen, touch [User Interface].

<Beep>*1

- **ON** (Initial): Activates the key-touch tone.
- **OFF**: Deactivates the key-touch tone.

<Language Select>

Select the text language used for on-screen information. For details, see "Initial settings" on page 4.

<Touch Panel Adjust>

Adjust the touch positions of the buttons on the screen.

Touch and hold the center of the marks at the lower left (①), then the upper right (②) as instructed.



- To reset the touch position, touch [Reset].
- To cancel the current operation, touch [Cancel].

<Clock>

Select the method to set the date and clock. For details, see "Calendar/clock settings" on page 5.

<Time Zone>*2

Select the time zone for your area. For details, see "Calendar/clock settings" on page 5.

<Clock Adjust>*2

Adjust the date and clock manually. For details, see "Calendar/clock settings" on page 5.

*1 Available only when <X'Over Network> is set to [2way].
(Page 27)

*2 Available when [Clock] is set to [Manual].

<DISP Key>

Select the screen displayed when [DISP] on the pop-up short-cut menu is touched.

- **Apps**: Switches to the App screen from the connected smartphone.
- **OFF** (Initial): Switches to the current source control screen.

Camera settings

Display the <Camera> screen.

On the Home screen, touch as follows:



Then, on the <SETUP> screen, touch [Camera].

<R-CAM Interruption>

- **ON** (Initial): Displays the picture from the rear view camera when you shift the gear to the reverse (R) position.
- **OFF**: Select this when no camera is connected.

<R-CAM for Car interface>

- **ON**: Selects when you connect an external system unit. (Neither buttons nor titles are displayed.)
- **OFF** (Initial): Selects when a rear view camera is connected.

Settings

<Parking Guidelines>

- **ON** (Initial): Displays the parking guidelines.
- **OFF**: Hides the parking guidelines.

<Guidelines Setup>

Adjust the parking guidelines according to the size of the car, parking space and so on.

When adjusting the parking guidelines, make sure to use the parking brake to prevent the car from moving.

Touch one of the  marks (①), then adjust the position of the selected  mark (②).

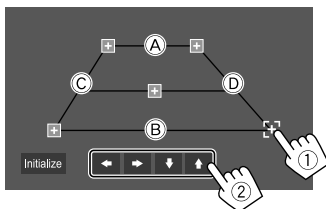

Make sure that (A) and (B) are horizontally parallel, and that (C) and (D) are the same length.

- Touch **[Initialise]** to set all the marks to the initial default position. A confirmation message appears. Touch **[Yes]**.

Special system settings

Display the <Special> screen.

On the Home screen, touch as follows:



Then, on the <SETUP> screen, touch **[Special]**.

<DEMO>

- **ON** (Initial): Activates the display demonstration.
- **OFF**: Deactivates the display demonstration.

<SETUP Memory>

- **Lock**: Locks the <Audio SETUP Memory>/<Audio SETUP Recall>/<Audio SETUP Clear> settings.
 - The items in the <Speaker/X'over> settings cannot be adjusted when **[Lock]** is selected.
- **Unlock**: Unlocks the settings.

<Audio SETUP Memory>*

Memorizes the following audio settings:

- Fader/Balance
- Speaker/X'over
- Equalizer (Adjustment on user preset (**[User1]** – **[User4]**)/Subwoofer level adjustment)
- Position/DTA
- Sound Effect

A confirmation message appears. Touch **[Yes]**.

<Audio SETUP Recall>*

Recall the settings memorized by <Audio SETUP Memory>. A confirmation message appears. Touch **[Yes]**.

<Audio SETUP Clear>*

Clear the settings made on the <Audio> screen. A confirmation message appears. Touch **[Yes]**.

<Software Information>

Display the information of the software (such as serial number, application version, system version, etc.). You can update the software.

<Open Source Licenses>

Show the Open Source Licenses.

<Initialise>

Initialize all settings made on the unit. A confirmation message appears. Touch **[Yes]**.

- The settings memorized on the <Audio SETUP Memory> are not initialized.

* Available only when <SETUP Memory> is set to **[Unlock]**.

Settings

Bluetooth settings

Display the <Bluetooth> screen.

On the Home screen, touch as follows:



Then, on the <SETUP> screen, touch **[Bluetooth]**.

<Bluetooth>

- **ON** (Initial): Activates the Bluetooth function of the unit.
- **OFF**: Deactivates the Bluetooth function of the unit.

<Select Device>

Connect or disconnect the paired device. (Page 21)

<Device Name>

Display/change the device name to be shown on the Bluetooth device. (Page 22)

<PIN Code>

Change the PIN code of the unit. (Page 22)

<Device Address>

Display the device address of the unit.

<TEL SETUP>

Configure the setting for using a Bluetooth mobile phone. (Page 26)

Security settings

Display the <Security> screen.

On the Home screen, touch as follows:



Then, on the <SETUP> screen, touch **[Security]**.

<Security Code Set>

Register the security code for the unit. (Page 4)

<Security Code Cancellation>

Clear the security code. (Page 4)

<Security Code Change>

Change the security code. (Page 4)

Remote Controller

You can use an optionally purchased remote controller, RM-RK258, for controlling the unit.

- Refer also to the instruction manual supplied with the remote controller.

Preparation

■ Removing the battery sheet

Pull the battery sheet out from the remote controller to activate the battery.

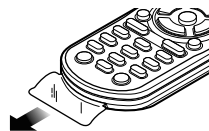

■ Changing the battery of the remote controller

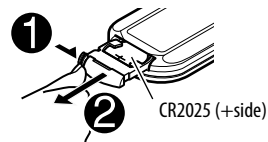

- Use a commercially available button battery (CR2025).
- Insert the battery with the + and – poles aligned properly.
 - If the effectiveness of the remote controller decreases, replace the battery.

Remote Controller

⚠ WARNINGS

• Do not ingest the battery, as it presents a chemical burn hazard

The remote controller supplied with this product contains a coin/button cell battery.

If the coin/button cell battery is swallowed, it can cause severe internal burns in just 2 hours and can lead to death.

Keep new and used batteries away from children.

If the battery compartment does not close securely, stop using the product and keep it away from children.

If you think batteries might have been swallowed or placed inside any part of the body, seek immediate medical attention.

⚠ CAUTION

- Do not leave the battery near fire or under direct sunlight. A fire, explosion or excessive heat generation may result.
- Do not set the remote controller in hot places such as on the dashboard.
- Danger of explosion if Lithium battery is incorrectly replaced. Replace only with the same or equivalent type.

Basic operations

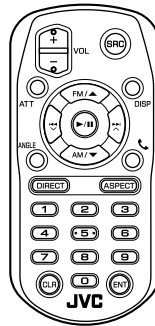

RM-RK258



ATT	Attenuates/restores the sound.
DISP	Displays the current source control screen.
FM/▲ /AM/▼	<ul style="list-style-type: none"> • Selects the band. • Selects a title/item/folder.
◀▶ / √ / ▲	<ul style="list-style-type: none"> • Tuner: <ul style="list-style-type: none"> – Searches for stations automatically. (Press)* – Searches for stations manually. (Hold)* • Selects a track. (Press)

VOL +/VOL -	Adjusts the volume level.
SRC	Selects the source.
▶/ 	<ul style="list-style-type: none"> Starts/pauses playback. Changes the seek mode (AUTO1, AUTO2, MANUAL).
☎	Answers incoming calls.
0 - 9	Enters a number.
ANGLE	Not used for this unit.
ASPECT	<ul style="list-style-type: none"> Changes the aspect ratio. • To check the current aspect ratio setting, operate on the touch panel. (Page 10)
ENT	Confirms selection.
DIRECT	Enters direct search mode.
CLR	Erases the misentry.

* The search method differs according to the selected seek mode.

Searching for a station frequency directly

While listening to the Tuner, you can search for a station frequency directly using the number buttons.

- 1 Press **DIRECT** to enter the search mode.
- 2 Press a number button to select a desired station frequency.
 - To erase a misentry, press **CLR**.
- 3 Press   to confirm.

To exit the search mode: Press **DIRECT**.

JVC Remote APP

JVC Remote is an application that connects and controls compatible JVC car receivers via Bluetooth® like a wireless remote control.

You can also operate this unit from a Smartphone using JVC Remote APP.

This application can display the source information of this unit on the smartphone's screen, and enables the user to make an audio setting using the graphic user interface of this application.

This application also works as a free standalone music player application, when your Smartphone is not connected to this unit.

- For details, visit www.jvc.net/car/app/jvc_remote/.

Installation and Connection

⚠ WARNINGS

- DO NOT connect the ignition wire (red) and the battery wire (yellow) to the car chassis (ground), you may cause a short circuit, that in turn may start a fire.
- DO NOT cut out the fuse from the ignition wire (red) and the battery wire (yellow). The power supply must be connected to the wires via the fuse.
- Always connect the ignition wire (red) and the battery wire (yellow) to the power source running through the fuse box.

⚠ CAUTIONS

- Install this unit in the console of your car.
- Do not touch the metal parts of this unit during and shortly after the use of the unit. Metal parts such as the heat sink and enclosure become hot.

Before installation

■ Precautions on installation and connection

- Mounting and wiring this product requires skills and experience. For best safety, leave the mounting and wiring work to professionals.
- Mount the unit so that the mounting angle is 30° or less.
- Make sure to ground the unit to a negative 12 V DC power supply.
- Do not install the unit in a location exposed to direct sunlight or excessive heat or humidity. Also avoid places with too much dust or the possibility of water splashing.
- Do not use your own screws. Use only the screws provided. If you use the wrong screws, you could damage the unit.
- After the unit is installed, check whether the brake lamps, blinkers, wipers, etc. on the car are working properly.
- Do not press hard on the panel surface when installing the unit to the car. Otherwise scratches, damage, or failure may result.
- If the power is not turned on ("Miswiring DC Offset Error", "Warning DC Offset Error" is displayed), the speaker wire may have a short circuit or have touched the chassis of the car and the protection function may have been activated. In this case, the speaker wire should be checked.
- Keep all cables away from heat dissipating metal parts.

Installation and Connection

- If your car's ignition does not have an ACC position, connect the ignition wires to a power source that can be turned on and off with the ignition key. If you connect the ignition wire to a power source with a constant voltage supply, such as with battery wires, the battery may be drained.
- If the fuse blows, first make sure the wires are not touching to cause a short circuit, then replace the old fuse with one with the same rating.
- Insulate unconnected wires with vinyl tape or other similar material. To prevent a short circuit, do not remove the caps and do not let the cable out at the ends of the unconnected wires or the terminals.
- Secure the wires with cable clamps and wrap vinyl tape around the wires that comes into contact with metal parts to protect the wires and to prevent short circuit.
- Connect the speaker wires correctly to the terminals to which they correspond. The unit may be damaged or fail to work if you share the ⊖ wires or ground them to any metal part in the car.
- When only two speakers are being connected to the system, connect both connectors either to the front output terminals or to the rear output terminals (do not mix front and rear). For example, if you connect the ⊕ connector of the left speaker to a front output terminal, do not connect the ⊖ connector to a rear output terminal.

■ Parts list for installation

Note: This parts list does not include all the package contents.

- 1 Wiring harness (× 1)
- 2 Extension parking cable, 2 m (× 1)
- 3 Microphone, 3 m (× 1)
- 4 Mounting sleeve (× 1)
- 5 Trim plate (× 1)
- 6 Extraction keys (× 2)

■ Installation procedure

- 1 **Remove the key from the ignition and disconnect the ⊖ battery.**
- 2 **Make the proper input and output wire connections for each unit.**
- 3 **Connect the speaker wires of the wiring harness.**
- 4 **Take Connector B on the wiring harness and connect it to the speaker connector in your vehicle.**
- 5 **Take Connector A on the wiring harness and connect it to the external power connector in your vehicle.**
- 6 **Connect the wiring harness to the unit.**
- 7 **Install the unit in your car.**
Make sure that the unit is installed securely in place. If the unit is unstable, it may malfunction (e.g., the sound may skip).
- 8 **Reconnect the ⊖ battery.**
- 9 **Configure <Initial Settings>. (Page 4)**

Installation and Connection

Installing the unit

■ Installing the unit using the mounting sleeve

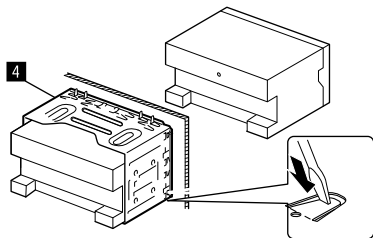

Bend the tabs of the mounting sleeve with a screwdriver or similar utensil and attach it in place.

■ Installing the trim plate

Remove the separator of the trim plate (5), then attach the trim plate (5) to the unit.

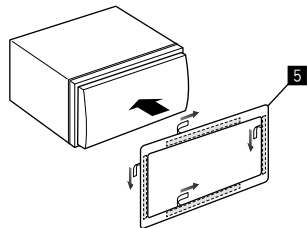

Removing the unit

1 Remove the trim plate (5).

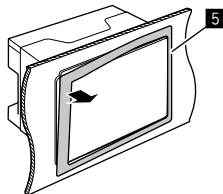

2 Remove the unit by inserting the two extraction keys (6), then pulling them as illustrated.

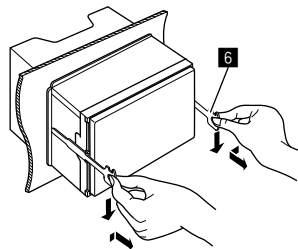

Be careful to avoid injury from the catch pins on the extraction key.

Connecting external components

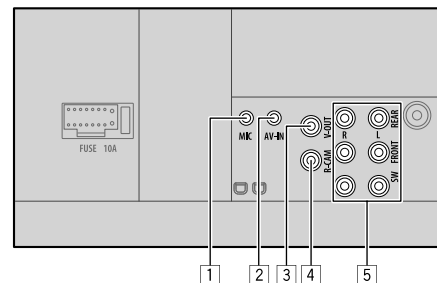

1 Microphone input (MIC) (Page 39)

2 Audio video input (AV-IN)

Connect the following type of 4-pole mini plug:

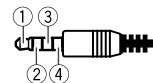

1 Left audio

2 Right audio

3 Ground

4 Composite video

3 Video output (V-OUT)

4 Rear view camera input (R-CAM)

5 Output terminals*

• Left output (White)

• Right output (Red)

REAR: Rear speaker preouts

FRONT: Front speaker preouts

SW: Subwoofer preouts

For 3-way crossover:

REAR: Tweeter preouts

FRONT: Mid range speaker preouts

SW: Woofer preouts

* When connecting an external amplifier, connect its ground wire to the chassis of the car; otherwise the unit may be damaged.

Installation and Connection

Wiring connection

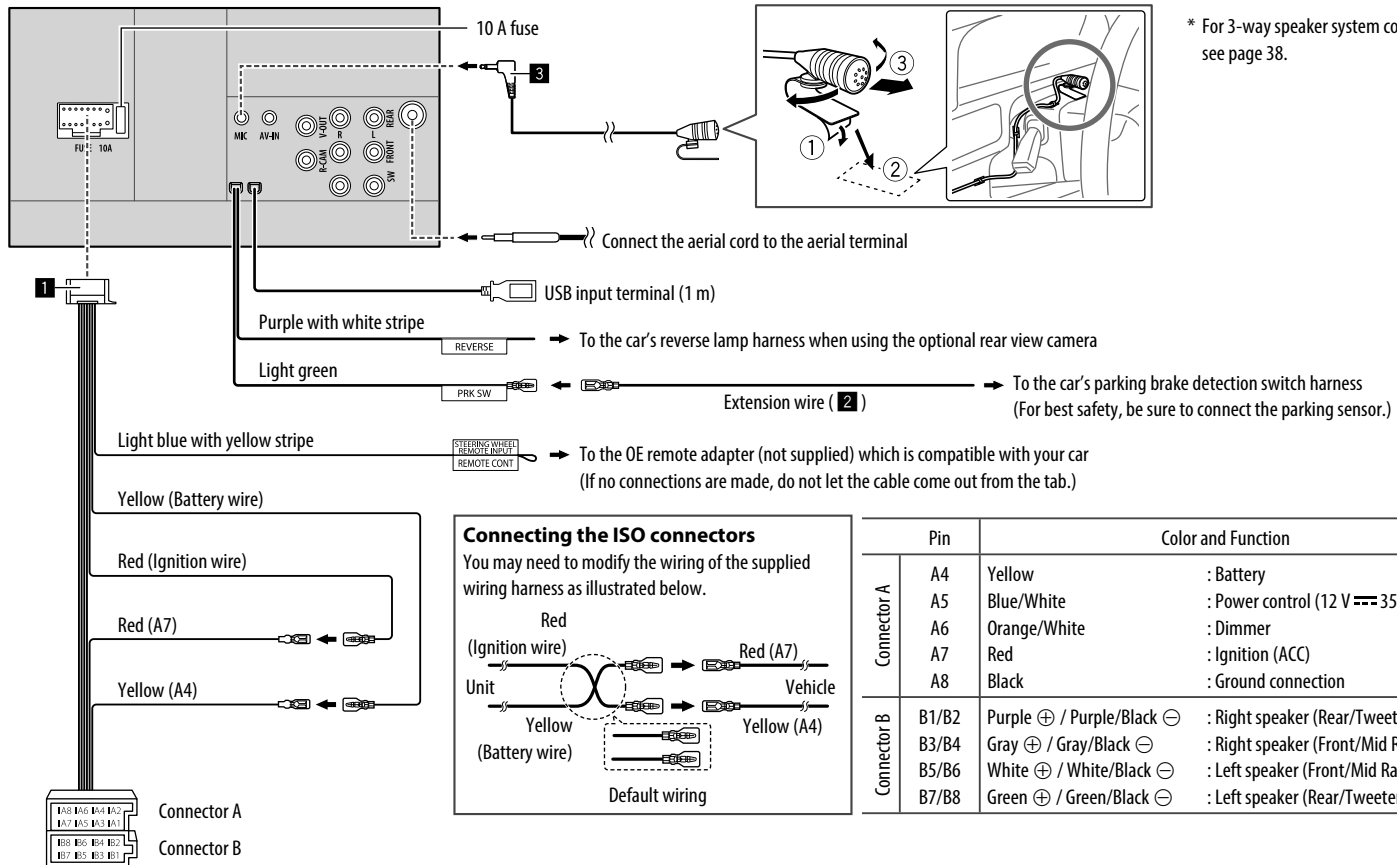

* For 3-way speaker system connection, see page 38.

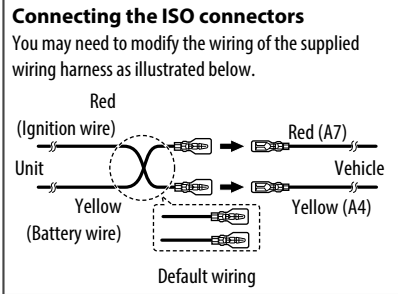

		Pin	Color and Function
Connector A	A4	Yellow	: Battery
	A5	Blue/White	: Power control (12 V \approx 350 mA)
	A6	Orange/White	: Dimmer
	A7	Red	: Ignition (ACC)
	A8	Black	: Ground connection
Connector B	B1/B2	Purple ⊕ / Purple/Black ⊖	: Right speaker (Rear/Tweeter*)
	B3/B4	Gray ⊕ / Gray/Black ⊖	: Right speaker (Front/Mid Range*)
	B5/B6	White ⊕ / White/Black ⊖	: Left speaker (Front/Mid Range*)
	B7/B8	Green ⊕ / Green/Black ⊖	: Left speaker (Rear/Tweeter*)

References

Maintenance

Cleaning the unit

- Do not use any solvent (for example, thinner, benzene, etc.), detergent, or insecticide. This may damage the monitor or the unit.
- Gently wipe the panel with a soft, dry cloth.

More information

About playable files

Audio files

- This unit can play back the following files with following codec and extension code:
 - For USB mass storage class device: MP3 (.mp3), WMA (.wma), WAV (.wav), AAC (.m4a), FLAC (.flac)
- This unit can play back files that meet the conditions below:
 - Bit Rate:
 - For USB:
MP3/WMA/AAC: 8 kbps – 320 kbps
 - Sampling Frequency:
 - For USB:
MP3/WMA/AAC: 16 kHz – 48 kHz
WAV/FLAC: 16 kHz – 96 kHz
 - Files recorded in VBR (variable bit rate), and have a discrepancy in elapsed time indication

- This unit can show or display the following:
 - Tag:
 - MP3: ID3 Tag (version 1.0/1.1/2.2/2.3/2.4)
 - WMA Tag
 - WAV Tag
 - AAC Tag
 - FLAC Tag
 - Jacket picture:
 - Picture size: 32 × 32 to 1 232 × 672 resolution
 - Data size: less than 500 KB
 - File type: JPEG/PNG/BMP
- This unit cannot play back the following files:
 - MP3 files encoded with MP3i and MP3 PRO format.
 - MP3 files encoded with Layer 1/2.
 - WMA files encoded with lossless, professional, and voice format.
 - WMA files which are not based upon Windows Media® Audio.
 - WMA/AAC files copy-protected with DRM.
 - AAC files copy-protected with FairPlay (except those stored on an iPod/iPhone).
 - Files which have data such as AIFF, ATRAC3, etc.

Video files

- This unit can play back the following files with following codec and extension code:
 - For USB mass storage class device: MPEG1/MPEG2 (.mpg, .mpeg), MPEG4 (.mp4, .m4v), H.264 (.mp4, .m4v, .avi, flv, f4v), WMV (.wmv)*, MKV (.mkv)
- * **Maximum resolution: 640 × 480**
- Streams that conform to:
 - Audio: MP3 or Dolby Audio
 - MPEG1/MPEG2:
 - Audio: MPEG1 Audio Layer-2 or Dolby Audio
 - Video: MPEG system/program stream

- Other playable conditions:
 - MPEG1/MPEG2: File format: MP@ML (Main Profile at Main Level)/SP@ML (Simple Profile at Main Level)/MP@LL (Main Profile at Low Level)
 - Video output format: NTSC (by default)
- This unit can playback a file with the size less than 4 GB.

About USB playback

Important

Make sure all important data has been backed up to avoid losing the data. We bear no responsibility for any loss of data stored in the devices while using this unit.

Playable files on a USB device

- This unit can play the following types of files stored in a USB mass storage class device.
 - MPEG1/MPEG2/MPEG4/H.264/WMV/MKV/MP3/WMA/WAV/AAC (.m4a)/FLAC
- This unit can recognize:
 - A total of 5 000 files
 - 250 folders for video files and a maximum of 9 999 files per folder
 - 250 folders for photo files and a maximum of 9 999 files per folder
 - 9 999 folders for audio files and a maximum of 1 000 files per folder
- The maximum number of characters (when the characters are 1 byte):
 - Folder names: 50 characters
 - File names: 50 characters

References

Notes on using a USB device

- Avoid using the USB device if it might affect driving safety.
- When connecting with a USB cable, use a USB 2.0 cable.
- Electrostatic shock at connecting a USB device may cause abnormal playback of the device. In this case, disconnect the USB device then reset this unit and the USB device.
- Do not pull out and connect the USB device repeatedly while "Reading" is shown on the screen.
- Operation and power supply may not work as intended for some USB devices.
- Do not leave a USB device in the car, or expose to direct sunlight or high temperatures to prevent deformation or damage to the device.

Unplayable USB device

- This unit may not play back files in a USB device properly when using a USB extension cable.
- USB devices equipped with special functions such as data security functions cannot be used with the unit.
- Do not use a USB device with 2 or more partitions.
- Depending on the shape of the USB devices and connection ports, some USB devices may not be attached properly or the connection might be loose.
- This unit may not recognize a memory card inserted into a USB card reader.

About iPod/iPhone

Important

Make sure all important data has been backed up to avoid losing the data.

We bear no responsibility for any loss of data stored in the devices while using this unit.

iPod/iPhone that can be connected

- Made for
 - iPod nano (7th Generation)*
 - iPod touch (6th Generation)
 - iPod touch (5th Generation)
 - iPhone 7 Plus
 - iPhone 7
 - iPhone SE
 - iPhone 6S Plus
 - iPhone 6S
 - iPhone 6 Plus
 - iPhone 6
 - iPhone 5S
 - iPhone 5C
 - iPhone 5

* Available only when connecting via USB input terminal.

Notes on using an iPod/iPhone

- When operating an iPod/iPhone, some operations may not be performed correctly or as intended. In this case, visit the following JVC web site:
<<http://www.jvc.net/cs/car/>>
- When you turn on this unit, the iPod/iPhone is charged through the unit.
- The text information may not be displayed correctly.
- For some iPod/iPhone models, the performance may be abnormal or unstable during operation. In this case, disconnect the iPod/iPhone device, then check its condition.
If the performance is not improved or slow, reset your iPod/iPhone.

Troubleshooting

What appears to be trouble is not always serious. Check the following points before calling a service center.

- For operations with external components, refer also to the instructions supplied with the adapters used for connection (as well as the instructions supplied with the external components).

General

No sound comes out of the speakers.

- Adjust the volume to the optimum level.
- Check the cords and connections.

No picture is displayed on the screen.

- Turn on the screen. (Page 3)

The remote controller (separately purchased) does not work.

- Replace the battery.

“No Signal”/“No Video Signal” appears.

- Start playback on the external component connected to the AV-IN input terminal.
- Check the cords and connections.
- Signal input is too weak.

“Miswiring DC Offset Error”/“Warning DC Offset Error” appears.

- A speaker cord has shorted or it has come into contact with the car chassis. Wire or insulate the speaker cord as appropriate, then reset the unit.

“Parking off” appears.

- No playback picture is shown when the parking brake is not engaged.

USB

“Reading” does not disappear from the screen.

- Turn the power off and on again.

While playing a track, sound is sometimes interrupted.

- The tracks are not properly copied into the USB device. Copy the tracks again, and try again.

Tracks are not played back as you have intended them to play.

- Playback order may differ from the one played back using other players.

The source does not change to “USB” when you connect a USB device while listening to another source or “USB Device Error” appears when you connect a USB device.

- The USB port is drawing more power than the design limit.
- Turn the power off and unplug the USB device. Then, turn on the power and reattach the USB device.
- If the above does not solve the problem, turn the power off and on (or reset the unit) before replacing with another USB device.

iPod/iPhone

No sound comes out of the speakers.

- Disconnect the iPod/iPhone, then connect it again.
- Select another source, then reselect “iPod”.

The iPod/iPhone does not turn on or does not work.

- Check the connection.
- Update the firmware version.
- Charge the battery.
- Reset the iPod/iPhone.

Sound is distorted.

- Deactivate the equalizer either on this unit or the iPod/iPhone.

A lot of noise is generated.

- Turn off (uncheck) “VoiceOver” on the iPod/iPhone. For details, visit <<http://www.apple.com>>.

No operations are available when playing back a track containing artwork.

- Operate the unit after the artwork has loaded.

“Authorization Error” appears.

- Check whether the connected iPod/iPhone is compatible with this unit. (Page 41)

Troubleshooting

WebLink™

WebLink™ cannot be started.

- Check whether the latest version of WebLink™ App is installed on the connected smartphone.
- Check the connection.
- Charge the battery.
- Reset the smartphone.
- Reconnect your smartphone.

Radio

SSM automatic presetting does not work.

- Store stations manually. (Page 15)

Static noise while listening to the radio.

- Connect the antenna firmly.

AV-IN

No picture appears on the screen.

- Turn on the video component if it is not on.
- Connect the video component correctly.

Spotify

“Check App” appears.

- The Spotify application on the connected device has not started up.
- The Spotify application is not installed on the connected device.
- Reconnect your smartphone.
- Restart Spotify application.

“Please login or sign up.” appears.

- You have not been signed into Spotify.

“Please check internet connection.” appears.

- Check the internet connection.

“Unable to start Spotify.” appears.

- Restart Spotify application.
- Spotify application cannot be started or played in current condition.

“Please update the Spotify app on the phone.” appears.

- The Spotify application on the connected device is not the latest version. Update the application.

Bluetooth

Phone sound quality is poor.

- Reduce the distance between the unit and the Bluetooth mobile phone.
- Move the car to a place where you can get a better signal reception.

The sound is interrupted or skipped while using a Bluetooth audio player.

- Reduce the distance between the unit and the Bluetooth audio player. Disconnect the device connected for Bluetooth phone.
- Turn off, then turn on the unit. (When the sound is not yet restored) connect the player again.

The connected audio player cannot be controlled.

- Check whether the connected audio player supports AVRCP (Audio/Video Remote Control Profile).

The Bluetooth device does not detect the unit.

- Search from the Bluetooth device again.

The unit does not pair with the Bluetooth device.

- For devices compatible with Bluetooth 2.1: Register the device using a PIN code. (Page 20)
- For devices compatible with Bluetooth 2.0: Enter the same PIN code for both the unit and target device. If the PIN code of the device is not indicated in its instructions, try “0000” or “1234.”
- Turn off, then turn on the Bluetooth device.

Echo or noise occurs.

- Adjust the microphone unit position.
- Adjust the echo volume or noise reduction volume. (Page 22)

The unit does not respond when you try to copy the phonebook to the unit.

- You may have tried to copy the same entries (as stored) to the unit.

“Connection Error” appears.

- The device is registered but the connection has failed. Connect the registered device. (Page 21)

Troubleshooting

“Please Wait...” appears.

→ The unit is preparing to use the Bluetooth function. If the message does not disappear, turn off and turn on the unit, then connect the device again (or reset the unit).

“No Voice Device” appears.

→ The connected mobile phone does not have a voice recognition system.

“No Data” appears.

→ No phonebook data is contained in the connected Bluetooth phone.

“Initialise Error” appears.

→ The unit has failed to initialize the Bluetooth module. Try the operation again.

“Dial Error” appears.

→ Dialing has failed. Try the operation again.

“Hung Up Error” appears.

→ The call has not ended yet. Park your car, and use the connected mobile phone to end the call.

“Pick Up Error” appears.

→ The unit has failed to receive a call.

Specifications

■ Monitor section

Picture Size (W × H)	6.75 inches (diagonal) wide 151.8 mm × 79.7 mm
Display System	Transparent TN LCD panel
Drive System	TFT active matrix system
Number of Pixels	1 152 000 (800H × 480V × RGB)
Effective Pixels	99.99%
Pixel Arrangement	RGB striped arrangement
Back Lighting	LED

■ USB interface section

USB Standard	USB 2.0 High Speed
File System	FAT 16/FAT 32/NTFS
Maximum Power Supply Current	DC 5 V \overline{max} 1.5 A (× 1)
D/A Converter	24 bit
Audio Decoder	MP3/WMA/AAC (.m4a)/WAV/FLAC
Video Decoder	MPEG1/MPEG2/MPEG4/H.264/WMV/MKV
Frequency Response	96 kHz Sampling: 20 Hz to 20 000 Hz 48 kHz Sampling: 20 Hz to 20 000 Hz 44.1 kHz Sampling: 20 Hz to 20 000 Hz

Total Harmonic Distortion	0.02% (1 kHz)
Signal to Noise Ratio	104 dB
Dynamic Range	90 dB

■ Bluetooth section

Technology	Bluetooth 3.0
Frequency	2.402 GHz to 2.480 GHz
Output Power	+4 dBm (MAX), 0 dBm (AVE), Power Class 2
Maximum Communication Range	Line of sight approx. 10 m (32.8 ft)
Audio Codec	SBC/AAC
Multi Profile Support	Multi Profile
Profile	HFP (Hands Free Profile) 1.6 A2DP (Advanced Audio Distribution Profile) 1.3 AVRCP (Audio/Video Remote Control Profile) 1.5 GAP (Generic Access Profile) PBAP (PhoneBook Access Profile) 1.2 SPP (Serial Port Profile) 1.2

Specifications

FM tuner section

Frequency Range	87.5 MHz to 108.0 MHz (50 kHz)
-----------------	-----------------------------------

Usable Sensitivity (S/N: 30 dB, Dev. 22.5 kHz)	6.2 dBf (0.56 μ V/75 Ω)
--	-------------------------------------

Quieting Sensitivity (DIN S/N: 46 dB, Dev. 40 kHz)	15.2 dBf (1.58 μ V/75 Ω)
--	--------------------------------------

Frequency Response (\pm 3.0 dB)	30 Hz to 15 kHz
---------------------------------------	-----------------

Signal to Noise Ratio	68 dB (MONO)
-----------------------	--------------

Selectivity (\pm 400 kHz)	> 80 dB
------------------------------	---------

Stereo Separation	40 dB (1 kHz)
-------------------	---------------

LW tuner section

Frequency Range	153 kHz to 279 kHz (9 kHz)
-----------------	-------------------------------

Usable Sensitivity	45 μ V
--------------------	------------

MW tuner section

Frequency Range	531 kHz to 1 611 kHz (9 kHz)
-----------------	---------------------------------

Usable Sensitivity	28.5 μ V
--------------------	--------------

Video section

Color System of	NTSC/PAL
-----------------	----------

External Video Input	
----------------------	--

External Video Input Level (RCA jack/mini jack)	1 Vp-p/75 Ω
---	--------------------

External Audio Max Input Level (mini jack)	2 V/25 k Ω
--	-------------------

Video Output Level (RCA jack)	1 Vp-p/75 Ω
----------------------------------	--------------------

Audio section

Maximum Power (Front & Rear)	50 W \times 4
---------------------------------	-----------------

Full Bandwidth	22 W \times 4
----------------	-----------------

Power (Front & Rear)	(at less than 1% THD)
----------------------	-----------------------

Preout Level	4 V/10 k Ω
--------------	-------------------

Preout Impedance	\leq 600 Ω
------------------	---------------------

Speaker Impedance	4 Ω to 8 Ω
-------------------	--------------------------

Equalizer	13 Band
-----------	---------

Band	Frequency (Hz): 62.5/100/160/250/400/630/ 1k/1.6k/2.5k/4k/6.3k/10k/ 16k Level: -09 to +09 (-9 dB to +9 dB)
------	---

HPF (High Pass Filter)	Frequency (Hz): Through/30/40/50/60/70/ 80/90/100/120/150/180/ 220/250 Slope (dB/Oct): -6/-12/-18/-24 Gain (dB): -8/-7/-6/-5/-4/-3/-2/-1/0
------------------------	---

LPF (Low Pass Filter)	Frequency (Hz): 30/40/50/60/70/80/90/100/ 120/150/180/220/250/ Through Slope (dB/Oct): -6/-12/-18/-24 Gain (dB): -8/-7/-6/-5/-4/-3/-2/-1/0
-----------------------	---

Specifications

General

Operating Voltage	14.4 V (10.5 V to 16 V allowable)
Maximum Current Consumption	10 A
Installation Dimensions (W × H × D)	With sleeve: 182 mm × 111 mm × 160 mm Without sleeve (main unit installation size): 178 mm × 100 mm × 162 mm
Operational Temperature Range	-10°C to +60°C
Weight (Main Unit)	1.7 kg (including trim plate and sleeve)

Design and specifications are subject to change without notice.

Trademarks and licenses

- The “AAC” logo is a trademark of Dolby Laboratories.
- Microsoft and Windows Media are either registered trademarks or trademarks of Microsoft Corporation in the United States and/or other countries.
- “Made for iPod,” and “Made for iPhone” mean that an electronic accessory has been designed to connect specifically to iPod, or iPhone, respectively, and has been certified by the developer to meet Apple performance standards.
Apple is not responsible for the operation of this device or its compliance with safety and regulatory standards. Please note that the use of this accessory with iPod, or iPhone may affect wireless performance. iTunes, iPhone, iPod, iPod classic, iPod nano, and iPod touch are trademarks of Apple Inc., registered in the U.S. and other countries.
- Lightning is a trademark of Apple Inc.
- This item incorporates copy protection technology that is protected by U.S. patents and other intellectual property rights of Rovi Corporation. Reverse engineering and disassembly are prohibited.
- Android is a trademark of Google Inc.
- The Bluetooth® word mark and logos are registered trademarks owned by Bluetooth SIG, Inc. and any use of such marks by JVC KENWOOD Corporation is under license. Other trademarks and trade names are those of their respective owners.

- THIS PRODUCT IS LICENSED UNDER THE AVC PATENT PORTFOLIO LICENSE FOR THE PERSONAL USE OF A CONSUMER OR OTHER USES IN WHICH IT DOES NOT RECEIVE REMUNERATION TO
(i) ENCODE VIDEO IN COMPLIANCE WITH THE AVC STANDARD (“AVC VIDEO”) AND/OR (ii) DECODE AVC VIDEO THAT WAS ENCODED BY A CONSUMER ENGAGED IN A PERSONAL ACTIVITY AND/OR WAS OBTAINED FROM A VIDEO PROVIDER LICENSED TO PROVIDE AVC VIDEO. NO LICENSE IS GRANTED OR SHALL BE IMPLIED FOR ANY OTHER USE. ADDITIONAL INFORMATION MAY BE OBTAINED FROM MPEG LA, L.L.C. SEE [HTTP://WWW.MPEGLA.COM](http://www.mpegla.com)
- SPOTIFY and the Spotify logo are among the registered trademarks of Spotify AB.
- WebLink™ is a trademark of Abalta Technologies, Inc.
- YouTube and the YouTube logo are registered trademarks of Google Inc.
- libFLAC
Copyright (C) 2000-2009 Josh Coalson
Copyright (C) 2011-2013 Xiph.Org Foundation
Redistribution and use in source and binary forms, with or without modification, are permitted provided that the following conditions are met:
– Redistributions of source code must retain the above copyright notice, this list of conditions and the following disclaimer.

Specifications

- Redistributions in binary form must reproduce the above copyright notice, this list of conditions and the following disclaimer in the documentation and/or other materials provided with the distribution.
- Neither the name of the Xiph.org Foundation nor the names of its contributors may be used to endorse or promote products derived from this software without specific prior written permission.

THIS SOFTWARE IS PROVIDED BY THE COPYRIGHT HOLDERS AND CONTRIBUTORS "AS IS" AND ANY EXPRESS OR IMPLIED WARRANTIES, INCLUDING, BUT NOT LIMITED TO, THE IMPLIED WARRANTIES OF MERCHANTABILITY AND FITNESS FOR A PARTICULAR PURPOSE ARE DISCLAIMED. IN NO EVENT SHALL THE FOUNDATION OR CONTRIBUTORS BE LIABLE FOR ANY DIRECT, INDIRECT, INCIDENTAL, SPECIAL, EXEMPLARY, OR CONSEQUENTIAL DAMAGES (INCLUDING, BUT NOT LIMITED TO, PROCUREMENT OF SUBSTITUTE GOODS OR SERVICES; LOSS OF USE, DATA, OR PROFITS; OR BUSINESS INTERRUPTION) HOWEVER CAUSED AND ON ANY THEORY OF LIABILITY, WHETHER IN CONTRACT, STRICT LIABILITY, OR TORT (INCLUDING NEGLIGENCE OR OTHERWISE) ARISING IN ANY WAY OUT OF THE USE OF THIS SOFTWARE, EVEN IF ADVISED OF THE POSSIBILITY OF SUCH DAMAGE.

For updated information (the latest Instruction Manual, system updates, new functions, etc.),
please visit the following website:

<<http://www.jvc.net/cs/car/>>

