



# KW-M560BT KW-M56BT

---

MONITOR WITH RECEIVER  
**INSTRUCTION MANUAL**

JVCKENWOOD Corporation

- Updated information (the latest Instruction Manual, system updates, new functions, etc.) is available from  
<<https://www.jvc.net/cs/car/>>.



**android**  
auto

# Contents

## **Before Use 4**

Precautions.....	4
How to read this manual .....	4

## **Basic Operations 5**

Functions of the Buttons on the Front Panel ...	5
Turning on the Unit .....	5
Getting Started.....	6
Adjusting the volume .....	7
Touch screen operations .....	7
HOME screen descriptions.....	8
Source selection screen descriptions.....	8
Source control screen descriptions .....	10
FUNCTION screen.....	11
List screen .....	11

## **APPS 12**

Apple CarPlay Operation .....	12
Android Auto Operation.....	13
USB Mirroring Operation.....	14

## **USB 15**

Connecting a USB device .....	15
USB Basic Operation.....	15
Search Operation.....	17

## **Tuner 18**

Tuner Basic Operation .....	18
Memory Operation .....	19
Selecting Operation .....	19
Traffic Information .....	20
Tuner Setup .....	20

## **SiriusXM® 21**

SiriusXM® Basic Operation .....	21
Storing Channels in Preset Memory .....	22
Preset select .....	22
Direct search .....	23
Category/Channel search.....	23
Replay.....	24
SiriusXM Setup .....	24

## **Bluetooth Control 27**

Information for using Bluetooth® devices.....	27
Register from the Bluetooth device.....	28
Bluetooth Setup.....	28
Playing Bluetooth Audio Device .....	29
Using Hands-Free Unit.....	31

## **Other External Components 35**

View Camera .....	35
External audio/video players—AV-IN .....	36

<b>Setting Up</b>	<b>37</b>
Monitor Screen Setup .....	37
System Setup .....	37
User Interface Setup.....	38
Special Setup .....	38
Display Setup.....	39
AV Setup .....	40

<b>Controlling Audio</b>	<b>41</b>
Speaker/ X'over setup .....	41
Controlling General Audio.....	42
Equalizer Control .....	43
Volume Offset .....	44
Sound Effect .....	44
Listening Position/ DTA.....	45

<b>Remote control</b>	<b>46</b>
Functions of the Remote control Buttons .....	46

<b>Connection/Installation</b>	<b>47</b>
Before Installation .....	47
Installing the unit .....	48

<b>Troubleshooting</b>	<b>52</b>
Problems and Solutions .....	52
Error Messages .....	52

<b>Appendix</b>	<b>54</b>
Playable Media and Files.....	54
Specifications.....	55
About this Unit .....	57

# Before Use

## Precautions

### ⚠ WARNINGS

#### 📖 To prevent injury or fire, take the following precautions:

- To prevent a short circuit, never put or leave any metallic objects (such as coins or metal tools) inside the unit.
- Do not watch or fix your eyes on the unit's display when you are driving for any extended period.
- If you experience problems during installation, consult your JVC dealer.

#### 📖 Precautions on using this unit

- When you purchase optional accessories, check with your JVC dealer to make sure that they work with your model and in your area.
- You can select language to display menus, audio file tags, etc. See **User Interface Setup (P.38)**.
- The Radio Data System or Radio Broadcast Data System feature won't work where the service is not supported by any broadcasting station.

#### 📖 Protecting the monitor

- To protect the monitor from damage, do not operate the monitor using a ball point pen or similar tool with the sharp tip.

#### 📖 Cleaning the unit

- If the faceplate of this unit is stained, wipe it with a dry soft cloth such as a silicon cloth. If the faceplate is stained badly, wipe the stain off with a cloth moistened with neutral cleaner, then wipe it again with a clean soft dry cloth.

#### NOTE

- Applying spray cleaner directly to the unit may affect its mechanical parts. Wiping the faceplate with a hard cloth or using a volatile liquid such as thinner or alcohol may scratch the surface or erase screened print.

## 📖 How To Reset Your Unit

- If the unit or the connected unit fails to operate properly, reset the unit. Press the <Reset> button. The unit returns to factory settings.



#### NOTE

- Disconnect the USB device before pressing the <Reset> button. Pressing the <Reset> button with the USB device connected can damage the data stored in the USB device. For how to disconnect the USB device, see **Disconnect the USB device (P.15)**.
- When the unit is turned on after resetting, the Initial SETUP screen appears. See **Initial setup (P.6)**.

## How to read this manual

- The screens and panels shown in this manual are examples used to provide clear explanations of the operations. For this reason, they may be different from the actual screens or panels used, or some display patterns may be different.
- **Indication language:** English indications are used for the purpose of explanation. You can select the indication language from the **SETUP** menu. See **User Interface Setup (P.38)**.



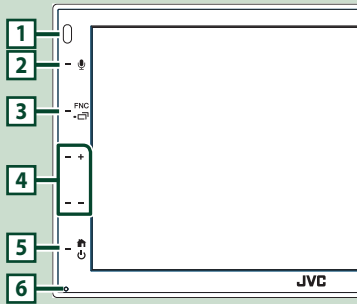

# Basic Operations

## Functions of the Buttons on the Front Panel



### NOTE

- The panels shown in this guide are examples used to provide clear explanations of the operations. For this reason, they may be different from the actual panels.

	Name
	<b>• Motion</b>
1	Remote Sensor • Receives the remote control signal.
2	 • Displays the Voice Recognition screen (P.32).
3	<b>FNC</b> /  • Displays the FUNCTION screen. • Pressing for 1 second displays the APP (Apple CarPlay/ Android Auto) screen.
4	+ , - (Volume) • Adjusts volume. The volume will go up until 15 when you keep pressing +.
5	 /  • Displays the HOME screen (P.8). • Pressing for 1 second turns the power off. • When the power off, turns the power on.
6	Reset • If the unit or the connected unit fails to operate properly, the unit returns to initial settings when this button is pressed.

## Turning on the Unit

- 1 Press the  button.



- > The unit is turned on.

### ● To turn off the unit:

- 1 Press the  button for 1 second.

### NOTE

- If it is your first time turning the unit on after installation, it will be necessary to perform Initial setup (P.6).

## Getting Started

### Initial setup

Perform this setup when you use this unit first time.

#### 1 Set each item as follows.

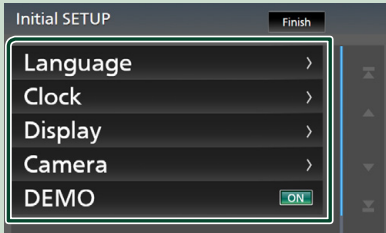

#### ■ Language

Select the language used for the control screen and setting items. Default is "American English(en)".

- 1 Touch **Language**.
- 2 Touch **Language**.
- 3 Select the desired language.
- 4 Touch

#### ■ Clock

Adjusts clock.

For detailed operation, see **Calendar/clock settings (P.6)**.

#### ■ Display

Set the image on the screen.

- 1 Touch **Display**.
- 2 Touch **Background**.
- 3 Select the image.
- 4 Touch

For detailed operation, see **Display Setup (P.39)**.

#### ■ Camera

Set the parameters for the camera.

- 1 Touch **Camera**.
- 2 Set each item and touch .

For detailed operation, see **Camera Setup (P.35)**.

#### ■ DEMO

Set the demonstration mode. Default is "ON".

- 1 Touch **DEMO** and set **ON** or **OFF**.

#### 2 Touch Finish .

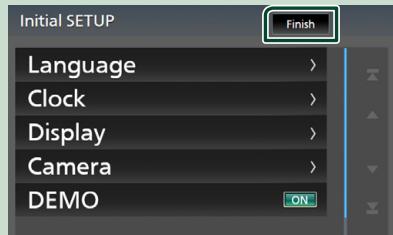

#### NOTE

- These settings can be set from the SETUP menu. See **Setting Up (P.37)**.

### Calendar/clock settings

#### 1 Press the FNC button.

➤ FUNCTION screen appears.

#### 2 Touch .

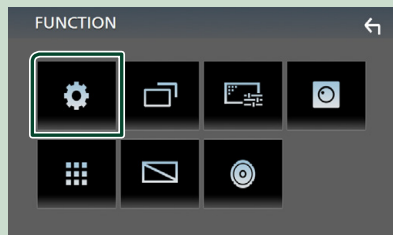

➤ SETUP Menu screen appears.

### 3 Touch User Interface.



➤ User Interface screen appears.

### 4 Touch Clock Adjust.

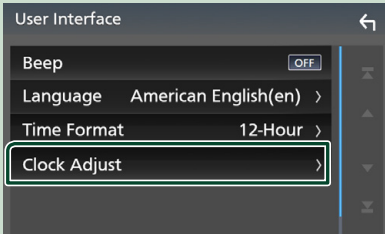

### 5 Adjust the date, then adjust the time.

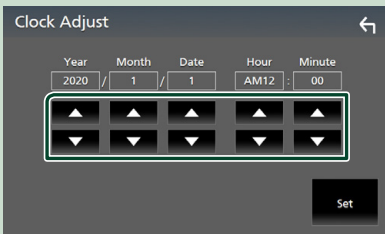

### 6 Touch Set.

#### NOTE

- Deactivate **RDS CT** before adjusting the clock. See **Tuner Setup (P.20)**.

## Adjusting the volume

To adjust the volume (0 to 40),  
Press + to increase, and press - to decrease.  
Holding + increases the volume continuously  
to level 15.



## Touch screen operations

To perform operations on the screen, you need  
to touch, touch and hold, flick or swipe to select  
an item, display setting menu screen or to  
change the page, etc.

#### ● Touch

Touch the screen gently to  
select an item on the screen.

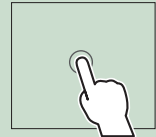

#### ● Touch and hold

Touch the screen and keep  
your finger in place until the  
display changes or a message  
is displayed.

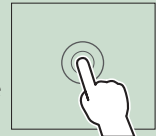

#### ● Flick

Slide your finger quickly to  
the left or right on the screen  
to change the page.

You can scroll the list screen  
by flicking the screen up/  
down.



#### ● Swipe

Slide your finger up or down  
on the screen to scroll the  
screen.



## Basic Operations

### Gesture Touch Control:

You can also control playback by moving your finger on the touch panel as follows (for some sources, the gesture control is not available).

- Sliding the finger towards up/down:
  - Functions same as pressing **+** / **-** (Media) in the USB Control screen.
  - For the Tuner, tuner preset broadcast stations are switched.
- Sliding the finger towards left/right: Functions same as pressing **◀◀** / **▶▶**.
- Moving your finger clockwise or counter-clockwise: increases/decreases the volume.

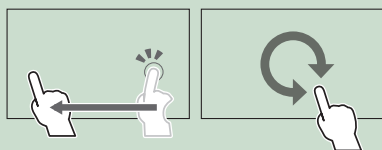

### HOME screen descriptions

Most functions can be performed from the HOME screen.

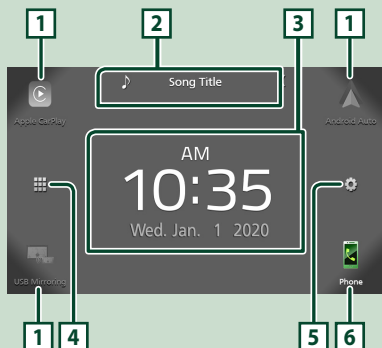

- |          |   |
|----------|---|
| <b>1</b> | • Short-cut playback source icons. <b>(P.9)</b>   |
| <b>2</b> | • Current source information.<br>• Touch to display the control screen of current source.   |
| <b>3</b> | • Widget  |
| <b>4</b> | • Displays the source selection screen. <b>(P.9)</b>  |
| <b>5</b> | • Displays the SETUP Menu screen. <b>(P.37)</b>   |
| <b>6</b> | • Displays the Hands Free screen. <b>(P.31)</b><br>• When connecting as Apple CarPlay or Android Auto, it works as a phone provided in Apple CarPlay or Android Auto. |

### Display the HOME screen

- 1** Press the  button.

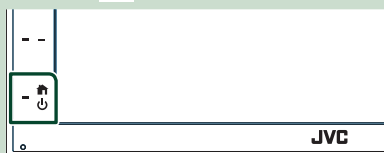

➤ HOME screen appears.

### Source selection screen descriptions

You can display all playback sources and options on the source selection screen.

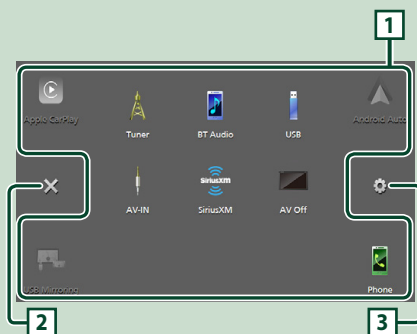











- |          |   |
|----------|---|
| <b>1</b> | • Changes the playback source.<br>For playback sources, see <b>Select the playback source (P.9)</b> . |
| <b>2</b> | • Returns to previous screen.   |
| <b>3</b> | • Displays the SETUP Menu screen. <b>(P.37)</b>   |



## Select the playback source

1 Touch  on the HOME screen.

From the screen, you can select the following sources and functions.

	<ul style="list-style-type: none"> <li>Switches to the Apple CarPlay screen from the connected iPhone. <b>(P.12)</b></li> </ul>
	<ul style="list-style-type: none"> <li>Switches to the Android Auto screen from the connected Android smartphone. <b>(P.13)</b></li> <li>It is necessary to connect Android smartphone compatible with Android Auto and to set <b>Mode to Android Auto</b>. <b>(P.14)</b></li> </ul>
	<ul style="list-style-type: none"> <li>Switches to the USB Mirroring screen from the connected Android smartphone. <b>(P.14)</b></li> <li>It is necessary to connect Android smartphone with "Mirroring OA for JVC" application installed and to set <b>Mode to Mirroring for Android™</b>. <b>(P.14)</b></li> </ul>
	<ul style="list-style-type: none"> <li>Displays the Hands Free screen. <b>(P.31)</b></li> <li>When neither Apple CarPlay, Android Auto, nor a Bluetooth Hands-Free phone is connected, displays "<b>Disconnected</b>" message in the TEL screen.</li> <li>When connecting as Apple CarPlay or Android Auto, it works as a phone provided in Apple CarPlay or Android Auto.</li> </ul>
	<ul style="list-style-type: none"> <li>Switches to the Radio broadcast. <b>(P.18)</b></li> </ul>
	<ul style="list-style-type: none"> <li>Plays a Bluetooth audio player. <b>(P.27)</b></li> </ul>
	<ul style="list-style-type: none"> <li>Plays files on a USB device. <b>(P.15)</b></li> </ul>
	<ul style="list-style-type: none"> <li>Switches to an external component connected to the AV-IN input terminal. <b>(P.36)</b></li> </ul>
	<ul style="list-style-type: none"> <li>Switches to the SiriusXM® satellite radio broadcast. <b>(P.21)</b></li> </ul>
	<ul style="list-style-type: none"> <li>Turns off the AV source. <b>(P.9)</b></li> </ul>

## To select the playback source on the HOME screen

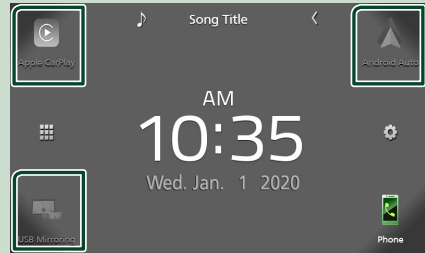

The 3 items displayed on the source selection screen as the large icons are shown on the HOME screen.

You can change items displayed on this area by customizing the source selection screen. **(P.10)**

## To turn off the AV source

1 Touch  on the HOME screen.

2 Touch **AV Off**.

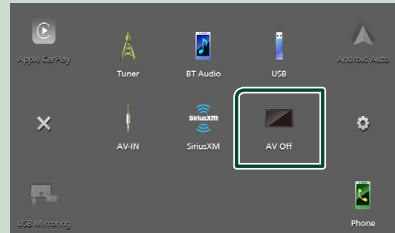

## Customize Short-cut buttons on HOME screen

You can arrange the position of the source icons as you like.

- 1 Touch  on the HOME screen.
- 2 Touch and hold the icon which you want to move to go into the customizing mode.
- 3 Drag it where you want to move.

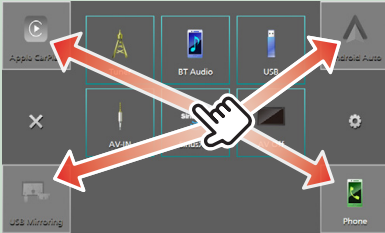

## Source control screen descriptions

There are some functions which can be operated from most screens.

### Indicators

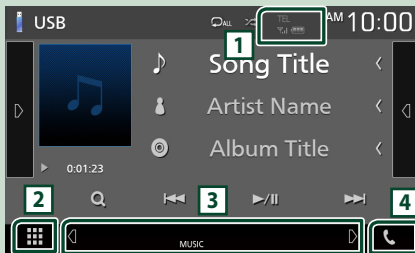

### Sub menu







Connected Bluetooth device information.



Displays all sources.

### 3 Secondary screen

-  /  : The Secondary screen changes every time you touch it. You can also change the Secondary screen by flicking left or right on the screen.
- Indicators: Displays the current source condition and so on.
  - **MUTE**: The mute function is active.
  - **LOUD**: The loudness control function is on.
- Sub menu
  - **DIM**: Operation when the icon is touched: The first touch darkens the screen, the second touch darkens the screen further, and the third touch restores the screen to its original brightness.
  -  : Displays the Graphic Equalizer screen. **(P.43)**
  -  : Displays the APP (Apple CarPlay/ Android Auto) screen **(P.12)**.



Touch to display the Hands Free screen.

**(P.31)**

When connecting as Apple CarPlay or Android Auto, it works as a phone provided in Apple CarPlay or Android Auto.

## FUNCTION screen

- 1 Press the **FNC** button.



➤ FUNCTION screen appears.

- 2 Touch to display the FUNCTION screen.

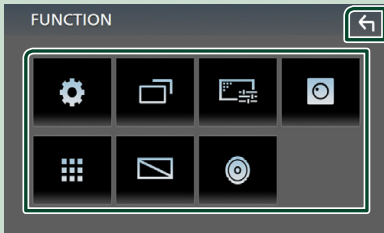

The contents of the menu are as follows.

	• Displays the SETUP Menu screen. (P.37)
	• Displays the APP (Apple CarPlay/ Android Auto) screen. (P.12)
	• Displays the Screen Adjust screen. (P.37)
	• Displays the view camera. (P.35)
	• Displays the source selection screen. (P.9)
	• Turns the display off. (P.11)
	• Displays the Audio screen. (P.41)
	• Close the FUNCTION screen.

## Turn off the screen

- 1 Select on the FUNCTION screen.



- To turn on the screen

- 1 Touch the display.

## List screen

There are some common function keys in the list screens of most sources.



Displays list type selection window.



Displays music/movie file list.



Scrolls the displayed text.

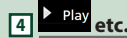

Keys with various functions are displayed here.

- : Plays all tracks in the folder containing the current track.
- : Moves to the upper hierarchy.



You can change the page to display more items by pressing / .

- / : Displays the top or bottom page.



Returns to previous screen.

### NOTE

- Buttons which cannot be activated from the list screen are not displayed.

# APPS

## Apple CarPlay Operation

Apple CarPlay is a smarter, safer way to use your iPhone in the car. Apple CarPlay takes the things you want to do with iPhone while driving and displays them on the screen of the product. You can get directions, make calls, send and receive messages, and listen to the music from iPhone while driving. You can also use Siri voice control to make it easier to operate iPhone.

For details about Apple CarPlay, visit <https://www.apple.com/ios/carplay/>.

### Compatible iPhone devices

You can use Apple CarPlay with the following iPhone models.

- iPhone 11 Pro Max
- iPhone 11 Pro
- iPhone 11
- iPhone XR
- iPhone XS Max
- iPhone XS
- iPhone X
- iPhone 8 Plus
- iPhone 8
- iPhone 7 Plus
- iPhone 7
- iPhone SE
- iPhone 6s Plus
- iPhone 6s
- iPhone 6 Plus
- iPhone 6
- iPhone 5s
- iPhone 5c
- iPhone 5

### Preparation

- 1 Connect iPhone using KS-U62 via USB terminal. (P.51)

When iPhone compatible with Apple CarPlay is connected to the USB terminal, the Bluetooth smartphone currently connected is disconnected.

- 2 Unlock your iPhone.

### Operation buttons and available Apps on the home screen of Apple CarPlay

You can use the Apps of the connected iPhone. The items displayed and the language used on the screen differ among the connected devices.

To enter Apple CarPlay mode, touch **Apple CarPlay** icon in the source selection screen. (P.9)

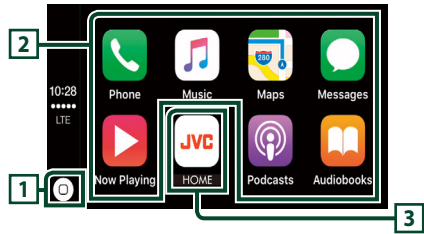

- 1

- Displays the home screen of Apple CarPlay.
- Touch and hold to activates Siri.

### 2 Application buttons

Starts the application.

### 3 HOME

Exits the Apple CarPlay screen and displays the Home screen.

### To exit the Apple CarPlay screen

- 1 Press the button.

### Use Siri

You can activate Siri.

- 1 Press the button.



- 2 Talk to Siri.

### Switch to the Apple CarPlay screen while listening to another source

- 1 Press the **FNC** / button for 1 second.



### NOTE

- If sound is output using Apple CarPlay when the Apple CarPlay screen is displayed, the source is switched to Apple CarPlay.

## Android Auto™ Operation

Android Auto enables you to use functions of your Android smartphone convenient for driving. You can easily access route guidance, make calls, listen to music, and access convenient functions on the Android smartphone while driving.

For details about Android Auto, visit <https://www.android.com/auto/> and <https://support.google.com/androidauto>.

### Compatible Android smartphone

You can use Android Auto with Android smartphone of Android version 5.0 or later.

#### NOTE

- Android Auto may not be available on all devices and is not available in all countries or regions.

### Preparation

#### 1 Connect an Android smartphone via USB terminal. (P.51)

To use the hands-free function, connect the Android smartphone via Bluetooth.

When an Android smartphone compatible with Android Auto is connected to the USB terminal, the device is connected via Bluetooth automatically, and the Bluetooth smartphone currently connected is disconnected.

#### 2 Unlock your Android smartphone.

#### NOTE

- To use the Android Auto, It is necessary to set **Mode** to **Android Auto**. (P.14)

### Operation buttons and available Apps on the Android Auto screen

You can perform the operations of the Apps of the connected Android smartphone. The items displayed on the screen differ among the connected Android smartphone.

To enter Android Auto mode, touch **Android Auto** icon in the source selection screen. (P.9)

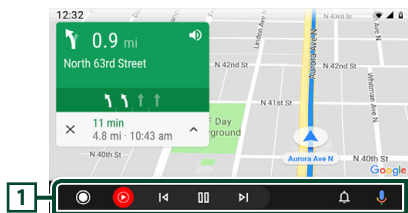

#### 1 Application/information buttons

Starts the application or displays information.

### To exit the Android Auto screen

#### 1 Press the button.

#### Using voice control

#### 1 Press the button.

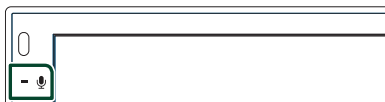

### To cancel

#### 1 Press the button.

#### Switch to the Android Auto screen while listening to another source

#### 1 Press the **FNC /** button for 1 second.



#### NOTE

- If sound is output using Android Auto when the Android Auto screen is displayed, the source is switched to Android Auto.

## USB Mirroring Operation (Android only)

You can display and control the App on the unit while your smartphone is connected to the USB terminal.

### Preparation

#### 1 Download Mirroring App from the Google Play.

Install the latest version of the Mirroring application "Mirroring OA for JVC" on your Android.

#### 2 Pair your smartphone with the unit via Bluetooth.

See *Register from the Bluetooth device (P.28)* and *Connect the Bluetooth device (P.29)*.

### Select a Device Mode

#### 1 Press the FNC button.

➤ FUNCTION screen appears.

#### 2 Touch .

➤ SETUP screen appears.

#### 3 Touch Device.



#### 4 Touch Mode.

#### 5 Touch Mirroring for Android™.

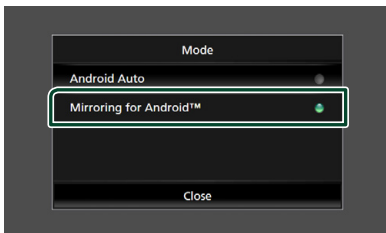

### Compatible Android smartphone

- Android version 7.0 or later
- Linux Kernel version 3.5 or later
- Bluetooth support

#### NOTE

- This unit may not work for some Android smartphone's.

### Connecting an Android smartphone

#### 1 Connect an Android smartphone via the USB terminal.

#### 2 Launch Mirroring App on your Android Smartphone.

Touch **OK** to start Mirroring App.

Touch **Start now** to start capturing your Android screen.

#### 3 Start to enjoy Mirroring.

### Mirroring OA Operation

#### 1 Operate your smartphone to activate Mirroring App, then connect to this unit.

#### 2 Press the button.

#### 3 Touch USB Mirroring.

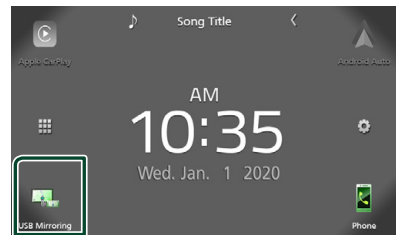

- You can display the same screen of the Android smartphone on the monitor of the unit.

# USB

## Connecting a USB device

- 1 Connect the USB device with the USB cable. (P.50)

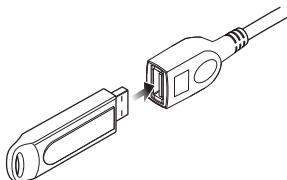

- 2 Press the button.
- 3 Touch .
- 4 Touch **USB**. (P.9)

## Disconnect the USB device

- 1 Press the button.
- 2 Touch .
- 3 Touch a source other than **USB**.
- 4 Detach the USB device.

## Usable USB device

You can use a mass-storage-class USB device on this unit.

The word “USB device” appearing in this manual indicates a flash memory device.

### ● About file system

The file system should be the one of the following.

- FAT16
- FAT32
- exFAT

### NOTE

- Install the USB device in the place where it will not affect safe driving.
- You cannot connect a USB device via a USB hub and Multi Card Reader.
- Take backups of the audio files used with this unit. The files can be erased depending on the operating conditions of the USB device. We shall have no compensation for any damage arising from any erased data.

## USB Basic Operation

Most functions can be controlled from the source control screen and playback screen.

### Control screen

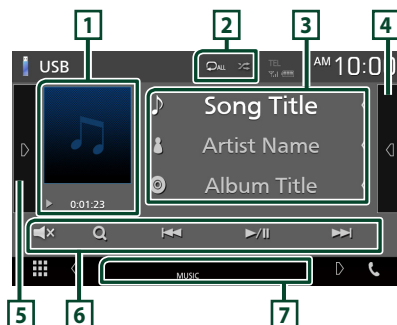

### Open the drawer

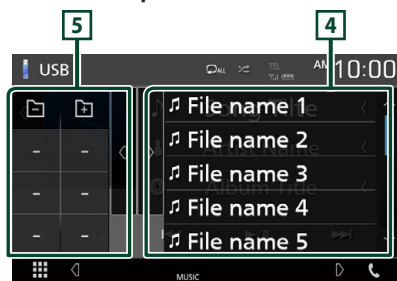







### 1 Artwork/ Play mode indicator/ Playing time

The jacket of the currently playing file is displayed.

- , etc.: Current play mode indicator  
The meanings of each icon are as follows;  
▶ (play), ▶▶ (fast forward), ◀◀ (fast backward), || (pause).

**2**  / 

-  : Repeats the current track/folder. Each time you touch the key, repeat mode switches in the following sequence; File repeat (  ), Folder repeat (  ), Repeat all (  )
-  : Randomly plays all tracks in current folder. Each time you touch the key, random mode switches in the following sequence; File random (  ), Random off (  )

**3** **Track information**



Displays the information of the current file. Only a file name and a folder name are displayed if there is no tag information.

**4** **Content list**





Touch on the right side of the screen to display the Content list. Touch again to close the list. Displays the playing list. When you touch a track/file name on the list, playback will start.

**5** **Function panel**

Touch on the left side of the screen to display the function panel. Touch again to close the panel.

-   : Searches previous/next folder.
- **ASPECT** (Only during video playback): Select screen mode.
  - Full** : Changes the aspect ratio of video and displays fully on the screen.
  - Normal** : Display with 4:3 ratio.
  - Auto** : Displays video fully on vertical or horizontal with no ratio change.

**6** **Operation keys**

-  : Searches track/file. For details on search operation, see **Search Operation (P.17)**.
-   : Searches the previous/next track/file. Touch and hold to fast forward or fast backward.
-  : Plays or pauses.
-  : Touch to mute or not to mute.

**7** **Indicator Items**

- **VIDEO** : Identifies the video file.
- **MUSIC** : Identifies the music file.

Video screen



**8** **Searching file area (Video file only)**

Touch to search the next/previous file.

**9** **Key display area (Video file only)**

Touch to display the control screen.



## Search Operation

You can search music or video files by the following operations.

- 1 Touch **Q**.
- 2 Touch **▼**.



- 3 Select the list type.

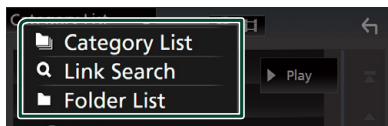

### NOTE

- For operations in the list screen, see **List screen (P.11)**.

## Category search

You can search a file by selecting category.

- 1 Touch **Category List**.
- 2 Select whether you search by audio files .
- 3 Touch the desired category.

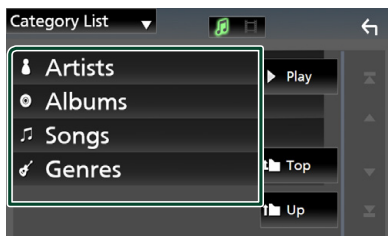

- ▶ The list corresponding to your selection appears.

- 4 Touch to select desired item in the list. Repeat this step until you find the desired file.

## Link search

You can search a file of same artist/album/genre as the current track.

- 1 Touch **Link Search**.
- 2 Touch the desired tag type. You can select from artist, album and genre.

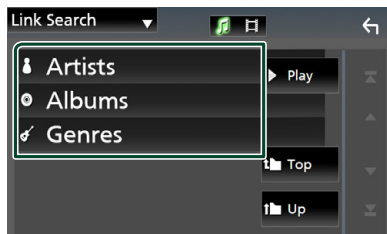

- ▶ The list corresponding to your selection appears.

- 3 Touch desired item from the content list.

## Folder search

You can search a file according to hierarchy.

- 1 Touch **Folder List**.

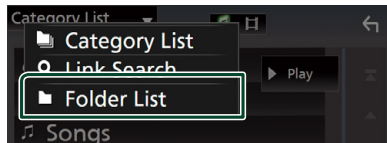

- 2 Touch the desired folder.

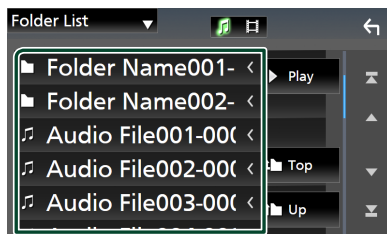

When you touch a folder its contents are displayed.

- 3 Touch to select desired item in the list. Repeat this step until you find the desired file.

# Tuner

## Tuner Basic Operation

Most functions can be controlled from the source control screen.

To enter Tuner source, touch **Tuner** icon in the source selection screen. (P.9)

### Control screen

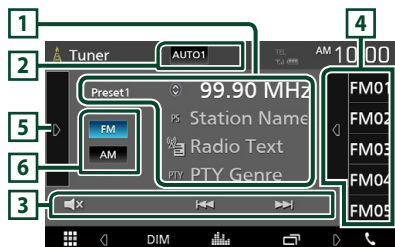

### Open the drawer

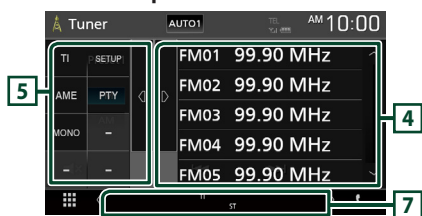

### 1 Information display

Displays the information of the current station:  
Frequency

Touching allows you to switch between Content A and Content B.

- Content A: PS name, Radio Text, PTY Genre
- Content B: Radio Text plus, Title Artist

**Preset#**: Preset number

### 2 Seek mode

Switches the seek mode in the following sequence; **AUTO1**, **AUTO2**, **MANUAL**.

- **AUTO1**: Tunes in a station with good reception automatically.
- **AUTO2**: Tunes in stations in memory one after another.
- **MANUAL**: Switches to the next frequency manually.

### 3 Operation keys

- : Tunes in a station. The method of frequency switching can be changed (see 2 in table).
- : Touch to mute or not to mute.

### 4 Preset list

- Touch on the right side of the screen to display the Preset list. Touch again to close the list.
- Recalls the memorized station.
- When touched for 2 seconds, stores the current receiving station in memory.

### 5 Function panel

Touch on the left side of the screen to display the function panel. Touch again to close the panel.

- **TI** (FM only): Sets the traffic information mode on. For details, see **Traffic Information (P.20)**.
- **SETUP**: Displays the Tuner SETUP screen. For details, see **Tuner Setup (P.20)**.
- **AME**: Presets stations automatically. For details, see **Auto memory (P.19)**.
- **PTY** (FM only): Searches a program by setting program type. For details, see **Search by program type (P.19)**.
- **MONO** (FM only): Select the Monaural reception.

### 6 FM AM

Switches the band.

### 7 Indicator Items

- **ST**: A stereo broadcast is being received.
- **MONO**: The forced monaural function is on.
- **TI**: Indicates the reception state of traffic information.
  - White: TP is being received.
  - Orange: TP is not being received.

## Memory Operation

### Auto memory

You can store stations with good reception in memory automatically.

#### 1 Touch desired band key.

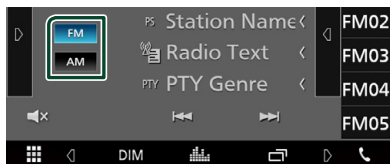

#### 2 Touch **▶** on the left side of the screen. Touch **AME**.

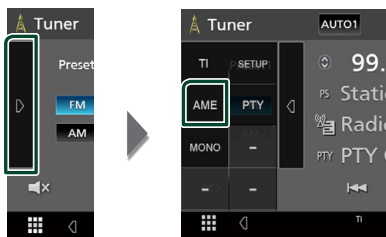

▶ A confirmation screen appears.

#### 3 Touch **Yes**.

▶ Auto memory starts.

### Manual memory

You can store the current receiving station in memory.

#### 1 Select a station you wish to store in memory.

#### 2 Touch **FM#** ( #: 1-24) or **AM#** ( #: 1-12) in which you want to store the station for 2 seconds.

## Selecting Operation

### Preset select

You can list and select memorized station.

#### 1 Touch **◀** on the right side of the screen. Select a station from the list.



### Search by program type (FM only)

You can tune to a station with a specific program type when listening to FM.

#### 1 Touch **▶** on the left side of the screen. Touch **PTY**.

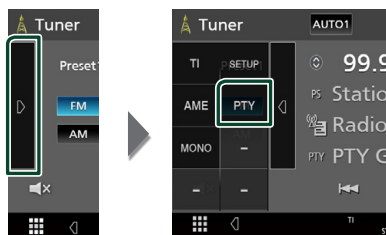

▶ PTY Search screen appears.

#### 2 Select a program type from the list.

#### 3 Touch **Search**.

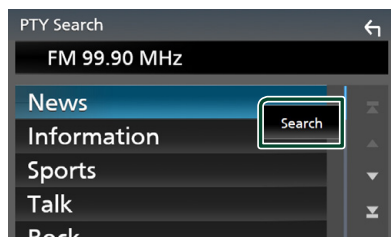

You can search a station of the selected program type.

## Traffic Information (FM only)

You can listen and watch the traffic information automatically when a traffic bulletin starts. However, this feature requires a Radio Broadcast Data System that includes the TI information.

- 1 Touch **▶** on the left side of the screen.  
Touch **TI**.

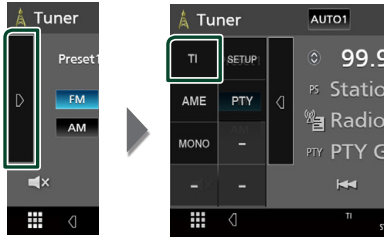

▶ Traffic information mode is set.

### When the traffic bulletin starts

The Traffic Information screen appears automatically.

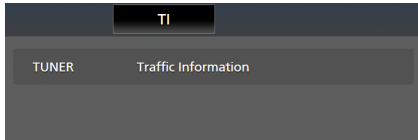

## Tuner Setup

You can set tuner related parameters.

- 1 Touch **FM**.
- 2 Touch **▶** on the left side of the screen.  
Touch **SETUP**.

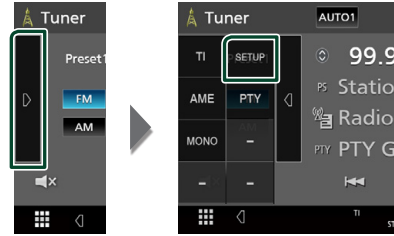

▶ Tuner SETUP screen appears.

- 3 Set each item as follows.

### ■ RDS CT (FM only)

Synchronizing the Radio Data System station time data and this unit's clock.

“ON” (Default), “OFF”

### ■ Area Setting

The tuner channel interval changes depending on the area where you use this unit.

**North America** (Default): Select this when using in North America. FM/AM intervals are set to 200 kHz/10 kHz.

**South America**: Select this when using in South America. FM/AM intervals are set to 50 kHz/10 kHz.

**Europe**: Select this when using in any other areas. FM/AM intervals are set to 50 kHz/9 kHz.

# SiriusXM®

## SiriusXM® Basic Operation

Only SiriusXM® brings you more of what you love to listen to, all in one place. Get over 140 channels, including commercial-free music plus the best sports, news, talk, comedy and entertainment. Welcome to the world of satellite radio. A SiriusXM Vehicle Tuner and Subscription are required. For more information, visit [www.siriusxm.com](http://www.siriusxm.com).

To listen to the SiriusXM source, touch the **SiriusXM** icon on the source selection screen. **(P.9)**

### Activating subscription

- Check your Radio ID.
  - The SiriusXM Satellite Radio ID is required for activation and can be found by tuning in Channel 0 as well as on the label found on the SiriusXM Connect tuner and its package. The Radio ID does not include the letters I, O, S or F.
- Activate the SiriusXM Connect Vehicle Tuner using either one of the two methods below:
  - For users in U.S.A.
    - Online: Visit [www.siriusxm.com/activatenow](http://www.siriusxm.com/activatenow)
    - Phone: Call SiriusXM Listener Care at 1-866-635-2349
  - For users in Canada:
    - Online: Visit <https://www.siriusxm.ca/help/activation-help/>
    - Phone: Call XM customer Care at 1-877-438-9677

### NOTE

- To use SiriusXM® Satellite Radio, the optional accessory is necessary.

### Control screen



### Open the drawer

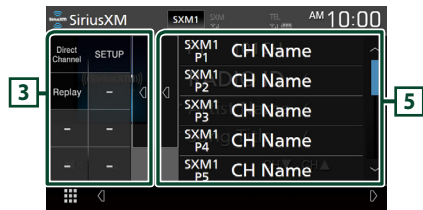

### 1 Information display

- Displays the information on the current channel: Channel Name
  - P#** : Preset number
  - #CH** : Channel number
  - Touching  allows you to switch between Content A and Content B.
    - Content A: Artist Name, Song Title
    - Content B: Content Info, Category Name

### NOTE

- While getting contents, "Waiting" is showing on the display.

### 2 Band button

Switches among bands. (SXM1/SXM2/SXM3)

### 3 Artwork / Function panel

- Displays the album artwork for most SiriusXM music channels.
- Touch **[D]** of the screen to display the function panel. Touch **[K]** to close the panel.
  - **Direct Channel**: Touch and enter the desired number. For details, see **Direct search (P.23)**.
  - **SETUP**: Touch to display the SiriusXM SETUP screen. For details, see **SiriusXM Setup (P.24)**.
  - **Replay/Live**: Touch to turn on or off the replay mode. See **Replay (P.24)**.

### 4 Operation keys

- **[Q]**: Display the Category search screen. For details on search operation, see **Category/Channel search (P.23)**.
- **[▶/||]**: Plays or pauses. See **Replay (P.24)**.
- **[CH▼ CH▲]**: Selects a channel.
- **[M/x]**: Touch to mute or not to mute.

### 5 Preset list

- Touch **[K]** of the screen to display the preset list. Touch **[D]** to close the list.
- Recalls the memorized channel.
- When touched for 2 seconds, stores the currently being received channel in the memory.

## Storing Channels in Preset Memory

You can store the current channel in memory.

- 1 Tune in the channel you wish to store in the memory.
- 2 Touch **[K]** on the right side of the screen.

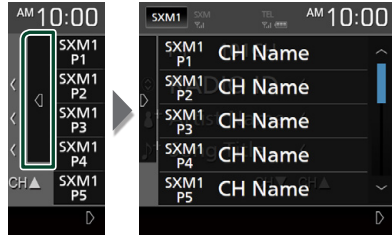

- 3 Touch **SXMM(1-3) P(1-6)** in which you want to store the channel for 2 seconds.

## Preset select

You can list and select memorized channels.

### To select from the preset list

- 1 Touch **[K]** on the right side of the screen. Select a channel from the list.

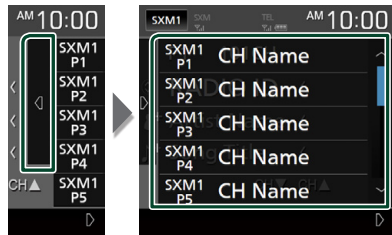

## Direct search

You can tune in a channel directly.

- 1 Touch **D** on the left side of the screen. Touch **Direct Channel**.

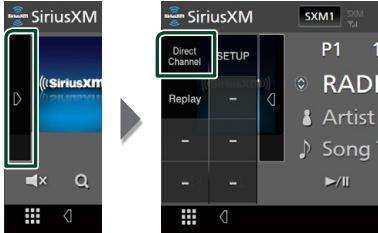

- 2 Enter the channel number and touch **Enter**.

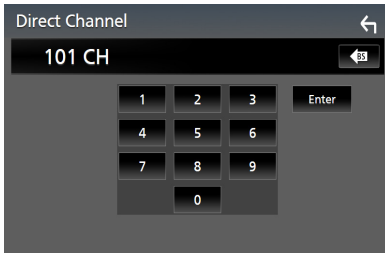

### NOTE

- To clear the number you entered, touch **BS**.

## Category/Channel search

You can specify the desired category and select a channel.

- 1 Touch **Q**.

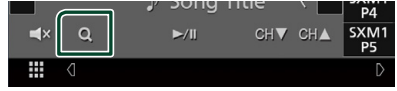

- 2 Select a category.

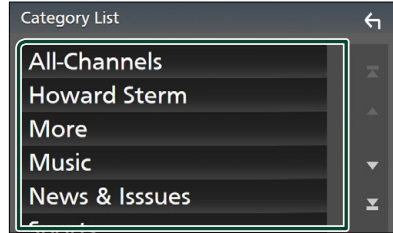

> Channel list appears.

- 3 Select the desired content from the list.



\*1 Select a desired item (**Info**, **CH Name**, **Artist**, **Title**).

### NOTE

- All channels in the selected category appear.
- Touching **All-Channels** displays all channels.

## Replay

You can replay the last 60 minutes of the program from the current channel.

- 1 Touch **▶||** or **Replay** on the function panel.

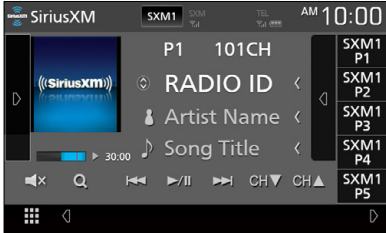

Press to skip to the previous/next track.  
Press and hold to rewind or fast forward.



Plays or pauses.



Displays the recorded data capacity and playback position.

▶, ▶▶, etc.: Current play mode indicator

### To return to live music/content

- 1 Touch the left side of the screen.
- 2 Touch **Live**.

## SiriusXM Setup

- 1 Touch **▶** on the left side of the screen. Touch **SETUP**.

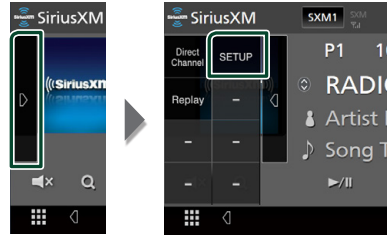

- ▶ SiriusXM SETUP screen appears.  
See the following sections for each setting.
  - Set up the Parental Code (**P.25**)
  - Set up the Parental Control (**P.25**)
  - Set up the Parental Lock Channel (**P.26**)
  - Reset to the default settings (**P.26**)



## Parental code

You can set a SiriusXM parental code for Parental Control.

### 1 Touch **Parental Code** on the SiriusXM **SETUP** screen.

- Parental Code Set screen appears.

#### NOTE

- The code number is set to "1111" as default.

### 2 Enter the current code number and touch **Enter**.

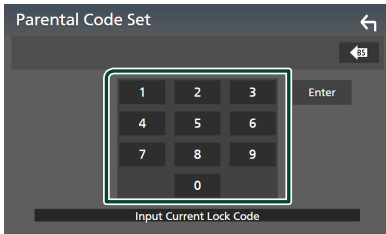

- Parental Code 1st screen appears.

### 3 Enter the new code number and touch **Enter**.

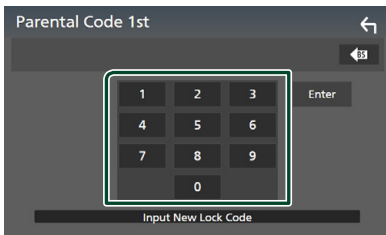

- Parental Code 2nd screen appears.

### 4 Enter the same code number as that you entered in step 3 and touch **Enter**.

- The code number is confirmed and the SiriusXM parental code is now set.

## Parental Control

The Parental Control feature allows you to limit access to any SiriusXM channels, including those with mature content. When enabled, the Parental Control feature requires you to enter a Parental Code to tune to the locked channels.

### 1 Touch **Parental Control** on the SiriusXM **SETUP** screen.

### 2 Touch **User**, **Mature** or **OFF**.

#### ■ **User**

Locks only the selected channels.

#### ■ **Mature**

Locks channels classified as "mature" only.

#### ■ **OFF**

Deactivates the parental mature and user locks.

### 3 Enter the parental code you originally input in as stated in **Parental code (P.25)** and touch **Enter**.

### When selecting User

This allows you to limit access to any SiriusXM channel (Parental Lock Channel).

#### 1 Touch **Parental Lock Channel Selection** on the SiriusXM SETUP screen.

- Parental Lock Code screen appears.

#### NOTE

- You need to set up a parental code beforehand as stated in *Parental code (P.25)*.

#### 2 Enter the parental code you originally input as stated in *Parental code (P.25)* and touch **Enter**.

- Parental Lock Category Select screen appears.

#### 3 Touch the desired category in the list.

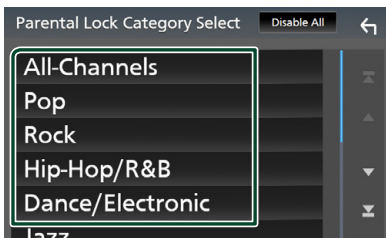

- Displays all channels in the selected category.

#### NOTE

- Touch **All-Channels** to display all channels.
- To delete the parental lock channel setting, touch **Disable All** and then touch **Yes** on the confirmation screen.

#### 4 Touch each channel on the list and set to **ON** or **OFF**.

**ON**: Locks the channel.

**OFF**: Unlocks the channel.

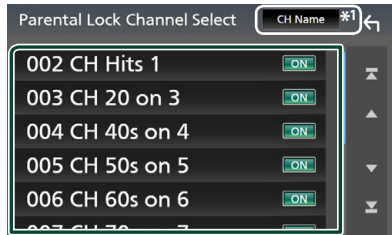

\*1 Select a desired item (Info, CH Name, Artist, Title).

#### Reset

#### 1 Touch **SiriusXM Reset** on the SiriusXM SETUP screen.

- Confirmation screen appears.

#### 2 Touch **Yes**.

- All SiriusXM settings are reset to defaults.

# Bluetooth Control

Using the Bluetooth function, various functions can be used: listening to the audio file, making/receiving a call.

## Information for using Bluetooth® devices



Bluetooth is a short-range wireless radio communication technology for mobile devices such as mobile phones, portable PCs, and other devices.

Bluetooth devices can be connected without cables and communicate with each other.

### NOTE

- While driving, do not perform complicated operations such as dialing numbers, using the phone book, etc. When you perform these operations, stop your car in a safe place.
- Some Bluetooth devices may not connect to this unit depending on the Bluetooth version of the device.
- This unit may not work for some Bluetooth devices.
- Connecting conditions may vary depending on your environment.
- For some Bluetooth devices, the device is disconnected when the unit is turned off.

## About the cell-phone and Bluetooth audio player

This unit conforms to the following Bluetooth specifications:

Version

Bluetooth Ver. 4.1

Profile

Cell-phone:

HFP (Hands Free Profile)

SPP (Serial Port Profile)

PBAP (Phonebook Access Profile)

Audio player:

A2DP (Advanced Audio Distribution Profile)

AVRCP (Audio/Video Remote Control Profile)

Sound codec

SBC, AAC

### NOTE

- The units supporting the Bluetooth function have been certified for conformity with the Bluetooth Standard following the procedure prescribed by Bluetooth SIG.
- However, it may be impossible for such units to communicate with your cell-phone depending on its type.

## Register from the Bluetooth device

It is necessary to register the Bluetooth audio player or cell-phone to this unit before using the Bluetooth function.

You can register up to 7 Bluetooth devices.

### NOTE

- Up to 7 Bluetooth devices can be registered. If an attempt is made to register the 8th Bluetooth device, the Bluetooth device connected on the earliest date will be deleted to register the 8th one.

- 1 Turn on the Bluetooth function on your smartphone/cell-phone.
- 2 Search the unit ("KW-M\*\*\*\*\*") from your smartphone/cell-phone.
- 3 Operate your smartphone/cell-phone according to the displayed messages.
  - Confirm the request on the smartphone/cell-phone.

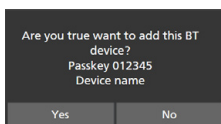

- If a PIN code is required, enter the PIN code ("0000").

- 4 Touch **Yes**.

When data transmission and connection have completed, the Bluetooth connection icon appears on the screen.

## Bluetooth Setup

- 1 Press the **FNC** button.
  - FUNCTION screen appears.
- 2 Touch .

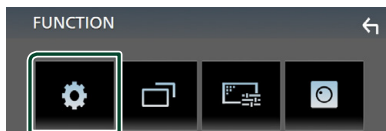

- SETUP Menu screen appears.

- 3 Touch **Bluetooth**.



- Bluetooth SETUP screen appears. See the following section for each setting.
- Connect the Bluetooth device ([P.29](#))

## Connect the Bluetooth device

- 1 Touch **Select Device** in the Bluetooth SETUP screen.

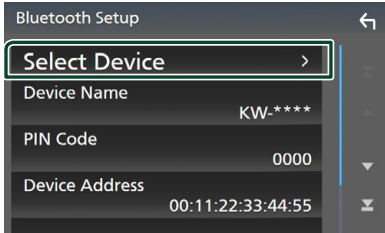

- 2 Touch **[C>]** you want to connect.

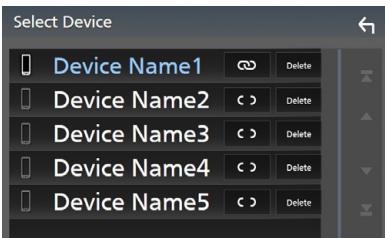

### NOTE

- If the icon is lighted, it means that the unit will use that device.

## To delete the registered Bluetooth device

- 1 Touch **Delete**.

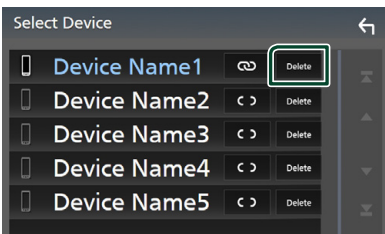

- Confirmation message appears.

- 2 Touch **Yes**.

## Playing Bluetooth Audio Device

Most function can be controlled from the source control screen.

To enter Bluetooth source, touch **BT Audio** icon in the source selection screen. (P.9)

## Bluetooth basic operation

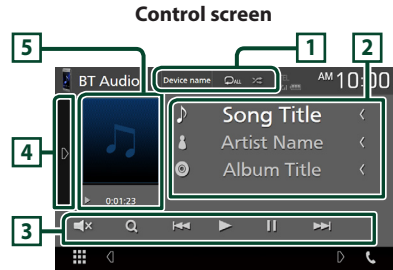

### 1 Device name/ [Repeat] / [Shuffle]

- Connected device name.
- [Repeat]: Repeats the current track/folder. Each time you touch the key, repeat mode switches in the following sequence; File repeat ([Repeat]), Folder repeat ([Repeat]), All songs repeat ([Repeat]), Repeat off ([Repeat]).
- [Shuffle]: Randomly plays all tracks in current folder. Each time you touch the key, random mode switches in the following sequence; All random ([Shuffle]), Random off ([Shuffle]).
- Operations and display indications may differ according to their availability on the connected device.

### 2 Information display \*

Displays the name of the track information.

### 3 Operation keys \*

- [Search]: Searches file. See **File search (P.30)**.
- [Previous/Next]: Searches the previous/next content. Touch and hold to fast forward or fast backward.
- [Play]: Plays.
- [Pause]: Pauses.
- [Mute]: Touch to mute or not to mute.

**4 Function panel**

Touch on the left side of the screen to display the function panel. Touch again to close the panel.

- **BT DEVICE CHANGE** : Selects the device to connect via Bluetooth audio (A2DP) or APP (SPP). See **Connect the Bluetooth audio (P.30)**.

**5 Play mode indicator/ Playing time**

▶, ||: Current play mode indicator

The meanings of each icon are as follows;  
▶ (play), ▶▶ (fast forward), ◀◀ (fast backward), || (pause).

\* These items appear only when the audio player which supports AVRCP profile is connected.

**NOTE**

- If the operation keys do not appear, operate from the player.
- Depending on your cell-phone or audio player, audio may be heard and controlled but text information may not appear.
- If the volume is too low, raise it on your cell-phone or audio player.

**Connect the Bluetooth audio**

Selects the device to connect via Bluetooth audio (A2DP) or APP (SPP).

- 1 Touch on the left side of the screen. Touch **BT DEVICE CHANGE**.

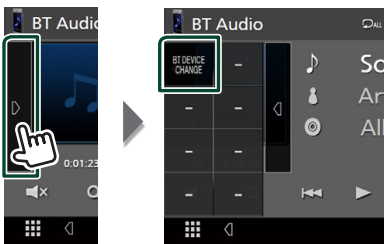

- 2 Touch the device name you want to connect.

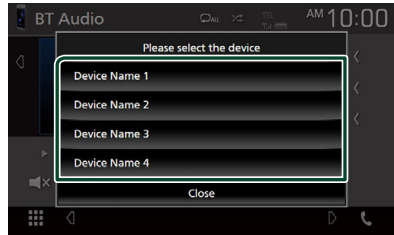

**File search**

- 1 Touch **Q**.
- 2 Touch the desired file or folder.

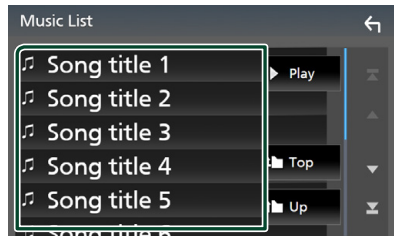

When you touch a folder its contents are displayed.

- 3 Touch desired item from the content list. ▶ Playback starts.

**NOTE**

- For operations in the list screen, see **List screen (P.17)**.

## Using Hands-Free Unit

You can use telephone function by connecting the Bluetooth telephone to this unit.

### NOTE

- While Apple CarPlay or Android Auto is being connected, Bluetooth Hands-Free function cannot be used. Only Apple CarPlay or Android Auto Hands-Free function can be used.

## Make a call

### 1 Touch Phone/📞.



➤ Hands Free screen appears.

### NOTE

- If your mobile phone supports PBAP, you can display the phone book and call lists on the touch panel screen when the mobile phone is connected.
  - Phone book: up to 1000 entries
  - Up to 20 entries including dialed calls, received calls, and missed calls

### 2 Select a dialing method.

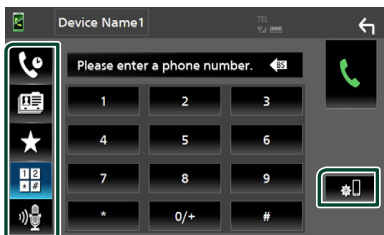

- 📞: Call using call records
- 📖: Call using the phonebook
- ★: Call using the preset number
- 📞: Call by entering a phone number
- 🗣️: Voice Recognition (**P.32**)
- 📶: Bluetooth SETUP

## Bluetooth SETUP

### 1) Touch 📶.

Bluetooth SETUP screen appears.

### NOTE

- The status icons such as battery and antenna displayed may differ from those displayed on the cell-phone.
- Setting the cell-phone in the private mode can disable the hands-free function.

## Call using call records

### 1 Touch 📞.

### 2 Select the phone number from the list.



## Call by entering a phone number

### 1 Touch 📞.

### 2 Enter a phone number with number keys.

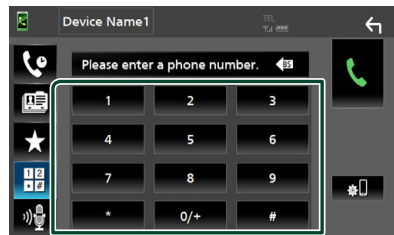

### 3 Touch 📞.

## Bluetooth Control

### Call using the preset number

- 1 Touch .
- 2 Touch the Name or phone number.

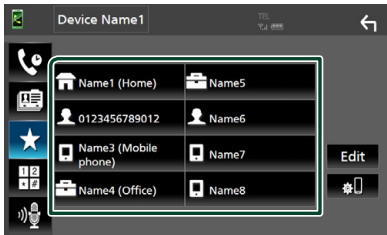

### Call using the phonebook

- 1 Touch .
- 2 Select the person you want to call from the list.



- 3 Select the phone number from the list.

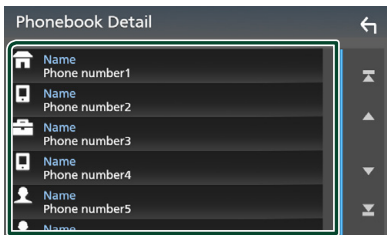

#### NOTE

- If no Phonebook has been downloaded, touching **Download Phonebook Now** will start downloading the Phonebook.

## Voice Recognition

You can access the voice recognition function of the cell-phone connected to this unit. You can search the cell-phone phonebook by voice. (The functionality depends on the cell-phone.)

- 1 Press the  button.



➤ Voice Recognition screen appears.



- 2 Start speaking.

#### NOTE

- You can use voice recognition function by touching  on the Hands Free screen.



## Receive a call

- 1 Touch  to answer a phone call or  to reject an incoming call.



### NOTE

- While monitoring the view camera, this screen does not appear even if a call comes in. To display this screen, return the shift knob of car to the driver position.



### To end call

- 1 While talking, touch .

## Operations during a call



### ● Adjust the receiver volume



Press the  or  button.





### ● Output the dial tone

Touch **DTMF** to display the tone input screen. You can send tones by touching desired keys on the screen.

### ● Switching the speaking voice output

Touching   each time switches the speaking voice output between cell-phone and speaker.

### ● Call-waiting

When you receive a call while talking on another call, you can answer the newly received call by touching . The current call is on hold. Each time you touch , the caller will change. When you touch , the current call will end and switch to the call in hold.

## Bluetooth Control

### Phone number preset

You can register frequently used phone numbers to this unit.

1 Touch .

2 Touch **Edit**.



3 Select where to preset.

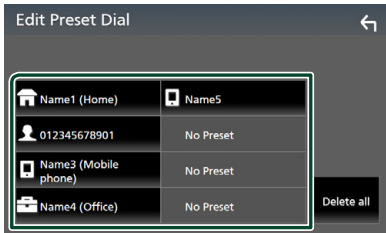

#### Delete all

To delete all preset numbers, touch **Delete all** and then touch **Yes** on the confirmation screen.

4 Select how to preset.

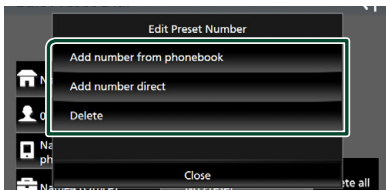

#### Add number from phonebook

Select the number to preset from the phonebook. See **Call using the phonebook (P.32)**.

#### Add number direct

Enter the telephone number directly and touch **SET**. See **Call by entering a phone number (P.31)**.

#### Delete

To delete a preset number, touch **Delete** and then touch **Yes** on the confirmation screen.

### Phonebook transfer

You can transfer the phonebook in your Bluetooth smartphone via PBAP.

1 Touch .

2 Touch .

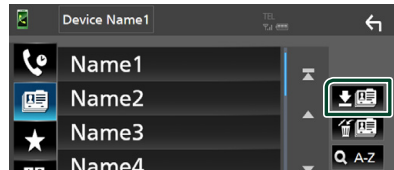

> The phonebook data transmission starts.

#### NOTE

- If the Phonebook contains more than 1000 entries, Phonebook data cannot be transferred.

### Phonebook deletion

1 Touch .

> Confirmation message appears.

2 Touch **Yes**.

# Other External Components

## View Camera

### NOTE

- To connect a camera, see **P.50**.
- To use a rear view camera, a REVERSE lead connection is required. (**P.50**)
- The rear view screen is displayed when you shift the gear to the reverse (R) position.

## Display the camera screen

- 1 Press the **FNC** button.
  - FUNCTION screen appears.

- 2 Touch .

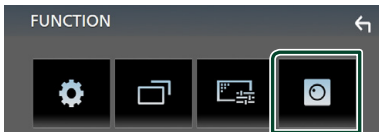

- View camera screen appears.

- 3 Adjust each item as follows.

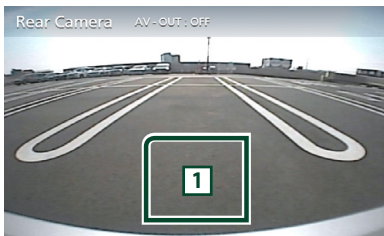

### 1 Camera off

Touch to exit the camera screen.

## Camera Setup

- 1 Press the **FNC** button.
  - FUNCTION screen appears.
- 2 Touch .

  - SETUP Menu screen appears.

- 3 Touch **Camera**.

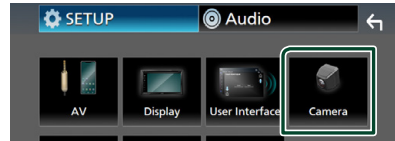

- Camera screen appears.

- 4 Set each item as follows.

### ■ Parking Guidelines

You can display parking guidelines to enable easier parking when you shift the gear to the reverse (R) position. Default is "ON".

### ■ Guidelines SETUP

If you select **ON** for **Parking Guidelines**, adjust the parking guidelines. See **To adjust the parking guidelines (P.36)**.

### To adjust the parking guidelines

#### NOTE

- Install the rear view camera in the appropriate position according to the instructions supplied with the rear view camera.
- When adjusting the parking guidelines, make sure to use the parking brake to prevent the car from moving.

- 1 Touch **ON** of **Parking Guidelines** in the Camera screen. (P.35)
- 2 Touch **Guidelines SETUP** in the Camera screen.
- 3 Adjust the parking guidelines by selecting the  mark.



- 4 Adjusting the position of the selected mark.

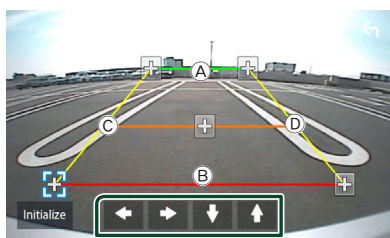

Make sure that (A) and (B) are horizontally parallel, and that (C) and (D) are the same length.

#### NOTE

- Touch **Initialize** and after touch **Yes** to set all the  marks to the initial default position.

## External audio/video players—AV-IN

- 1 Connect an external component to the AV-IN input terminal. (P.50)
- 2 Select **AV-IN** as the source. (P.9)
- 3 Turn on the connected component and start playing the source.

# Setting Up

## Monitor Screen Setup

You can adjust image quality in video screen.

- 1 Press the **FNC** button.  
 > FUNCTION screen appears.
- 2 Touch .

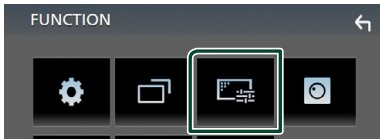

> Screen Control screen appears.

- 3 Adjust each item as follows.

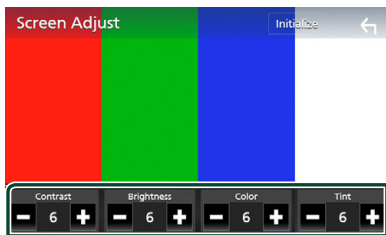

- **Contrast / Brightness / Color / Tint**  
Adjusts each item.

### NOTE

- Adjusting items are different depending on the current source.

## System Setup

- 1 Press the **FNC** button.  
 > FUNCTION screen appears.
- 2 Touch .

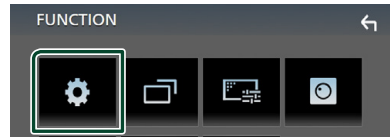

- > See the following section for each setting.
  - Set up AV ([P.40](#))
  - Set up display ([P.39](#))
  - Set up the user interface ([P.38](#))
  - Set up camera ([P.35](#))
  - Set up special ([P.38](#))
  - Set up Bluetooth ([P.28](#))
  - Set up Device ([P.14](#))

## User Interface Setup

You can setup user interface parameters.

- 1 Press the **FNC** button.
  - FUNCTION screen appears.
- 2 Touch .
- 3 Touch **User Interface**.



➤ User Interface screen appears.

- 4 Set each item as follows.
  - **Beep**  
Turns the key touch tone on or off.  
Default is "OFF".
  - **Language**  
Selects a language.
  - **Time Format**  
Select the time display format.  
"12-Hour" (Default)/ "24-Hour"
  - **Clock Adjust**  
Adjust the date and time manually. (P.6)

## Special Setup

You can setup Special parameters.

- 1 Press the **FNC** button.
  - FUNCTION screen appears.
- 2 Touch .
- 3 Touch **Special**.



➤ Special screen appears.

- 4 Set each item as follows.
  - **DEMO**  
Set the demonstration mode. Default is "ON".
  - **Software Information**  
Check the software version of this unit. (P.38)
  - **Open Source Licenses**  
Displays the open source licenses.
  - **Initialize**  
Touch **Initialize** and then touch **Yes** to set all the settings to the initial default settings.

### Software Information

Check the software version of this unit.

- 1 Touch **Software Information** in the Special screen.
- 2 Confirm the software version.

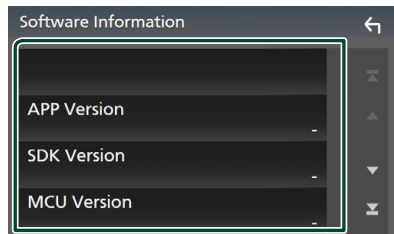

## Display Setup

- 1 Press the **FNC** button.
  - FUNCTION screen appears.
- 2 Touch .
  - SETUP screen appears.
- 3 Touch **Display**.



➤ Display screen appears.

- 4 Set each item as follows.

### ■ Dimmer

Select dimmer mode.

**OFF**: The display and buttons do not dim.

**ON**: The display and buttons dim.

**SYNC** (Default): Turns the dimmer function on or off when the vehicle light control switch is turned on or off.

### ■ OSD Clock

Select if you want to display the clock while the screen is off, or while watching video files on USB, etc.

"ON" (Default)/"OFF"

### ■ Screen Adjust

Displays the Screen Adjust screen. (P.37)

### ■ Background

Changing background image. (P.39)

## Change background image

- 1 Touch **Background** in the Display screen.
- 2 Select an image.

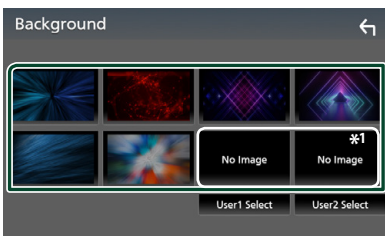

\*1 Select an original image in advance.

## To register original image

You can load an image from the connected USB device and set it for the background image.

Before operating this procedure, it is necessary to connect the device which has the image to load.

- 1 Touch **User1 Select** or **User2 Select** in the Background screen.
- 2 Select the image to load.

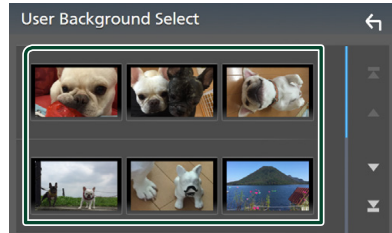

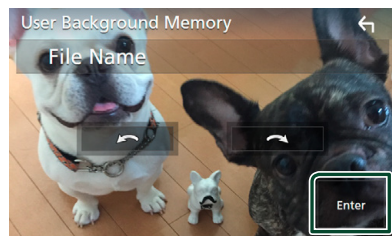

- 3 Touch **Enter**.



➤ The selected image is loaded and the display returns to the Background screen.

### NOTE

- Touching  rotates counter clockwise.
- Touching  rotates clockwise.
- Picture files: JPEG (.jpg, .jpeg), PNG (.png), BMP (.bmp)

## AV Setup

You can set AV parameters.

- 1 Press the FNC button.**
  - FUNCTION screen appears.
- 2 Touch .**
  - SETUP screen appears.
- 3 Touch AV.**



➤ AV screen appears.

- 4 Set each item as follows.**

### ■ AV-OUT

Specify whether to output the current source signal from the VIDEO OUT terminal.

“ON” / “OFF” (Default)

#### NOTE

- Images can be output only from the AV IN and USB (video file) source.
- If display of the rear view camera image is selected when the AV-IN source is being played, no image is output from the VIDEO OUT terminal.

### ■ CarPlay Sidebar

Select the position of the control bar (left or right) shown on the touch panel.

“Left” (Default) / “Right”

#### NOTE

- The setting is available when an iPhone is disconnected.

### ■ AV Color Adjust

You can adjust image quality in video screen.

(P.37)

#### NOTE

- Adjusting items are different depending on the current source.



# Controlling Audio

You can adjust the various settings such as audio balance or subwoofer level.

- 1 Press the **FNC** button.  
 > FUNCTION screen appears.
- 2 Touch .

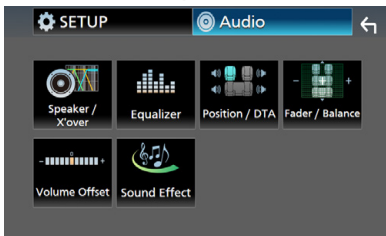

- > See the following section for each setting.
- Set up speaker/ X'over (P.41)
- Controlling equalizer (P.43)
- Set listening position/ DTA (P.45)
- Controlling general audio (Fader / Balance) (P.42)
- Set volume offset (P.44)
- Set sound effect (P.44)

## Speaker/ X'over setup

- 1 Press the **FNC** button.  
 > FUNCTION screen appears.
- 2 Touch .
- 3 Touch **Speaker/X'over**.

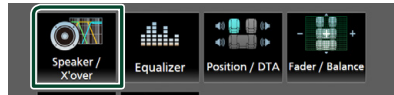

- 4 Select a car type.

You can setup the car type and speaker network, etc.

If your car type is selected, the Delay Time Alignment is set automatically (for timing adjustment of sound output for each channel) to have the highest surround effects.



- 5 Touch the speaker (①) you wish to adjust and set each item (②) as follows.

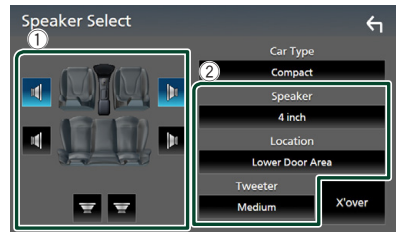

### ■ Speaker

You can select a speaker type and its size to get the best sound effects.

When the speaker type and size are set, the speaker crossover network is set automatically.

### ■ Location (Only for Front, Rear)

Select the speaker position you have fixed.

## Controlling Audio

### ■ Tweeter (Only for Front)

You can set the tweeter when you are selecting front speakers.

**None, Small, Medium, Large**

### ■ X'over

Displays the speaker crossover setup screen.

You can adjust the crossover setup that was set automatically when you selected the speaker type.

For details, see **Crossover network setup (P.42)**

## ■ Crossover network setup

You can set a crossover frequency of speakers.

### 1 Touch X'over.



### 2 Touch the speaker to set.



### 3 Set each item as follows.

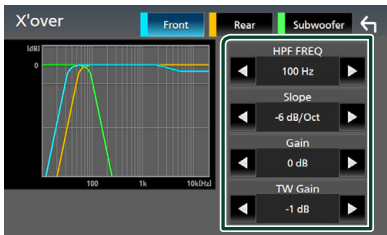

### ■ HPF FREQ

High Pass Filter adjustment. (When front or rear speaker is selected on Speaker Select screen)

### ■ LPF FREQ

Low Pass Filter adjustment. (When subwoofer is selected on Speaker Select screen)

### ■ Slope\*1

Sets a crossover slope.

### ■ Gain

Adjusts the front speaker, rear speaker, or subwoofer level.

### ■ TW (Tweeter) Gain\*2

Adjusts the tweeter level. (When front is selected on Speaker Select screen)

### ■ Phase Inversion\*3

Sets the phase of subwoofer output.

Check **Phase Inversion** to shift the phase 180 degrees. (When subwoofer is selected on Speaker Select screen)

\*1 Only when "LPF FREQ"/"HPF FREQ" is set to a mode other than "Through" in **X'over**.

\*2 Only when "Tweeter" is set to "Small", "Medium", "Large" in **Speaker Setup**.

\*3 Only when "Subwoofer" is set to a mode other than "None" in **Speaker Setup**.

## Controlling General Audio

### 1 Press the FNC button.

➤ FUNCTION screen appears.

### 2 Touch .

➤ Audio screen appears.

### 3 Touch Fader / Balance.

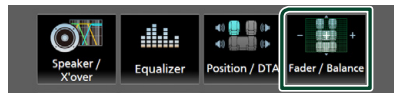

### 4 Set each item as follows.

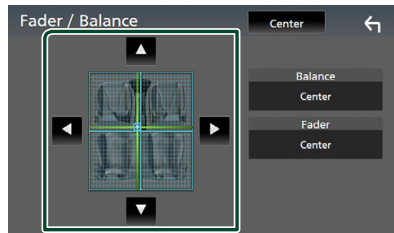

### ■ Fader / Balance

Adjust the volume balance around the touched area.

◀ and ▶ adjust the right and left volume balance.

▲ and ▼ adjust the front and rear volume balance.

### ■ Center

Clear the adjustment.

## Equalizer Control

You can adjust equalizer by selecting the optimized setting for each category.

- 1 Press the **FNC** button.  
➤ FUNCTION screen appears.
- 2 Touch .  
➤ Audio screen appears.
- 3 Touch **Equalizer**.

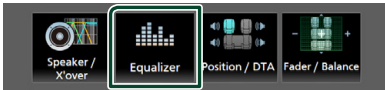

- 4 Touch the screen and set the Graphic Equalizer as desired.

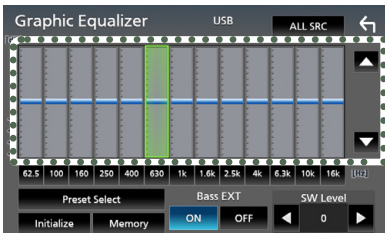

### ■ ALL SRC

Apply the adjusted equalizer to all sources. Touch **ALL SRC** and then touch **OK** on the confirmation screen.

### ■ Gain level (dotted frame area)

Adjust the gain level by touching each frequency bar.

You can select frequency bar and adjust its level by ▲, ▼.

### ■ Preset Select

Displays the screen to recall the preset equalizer curve.

### ■ Initialize

The current EQ curve returns to flat.

### ■ Memory

Saves the adjusted equalizer curve from "User1" to "User3".

### ■ Bass EXT (Bass Extend Settings)

When turned on, the frequency lower than 62.5 Hz is set to the same gain level as 62.5 Hz.

### ■ SW Level

Adjusts the subwoofer volume.

## ■ Recall the EQ curve

- 1 Touch **Preset Select**.
- 2 Select EQ curve.



## ■ Save the EQ curve

- 1 Adjust the EQ curve.
- 2 Touch **Memory**.
- 3 Select where to save.

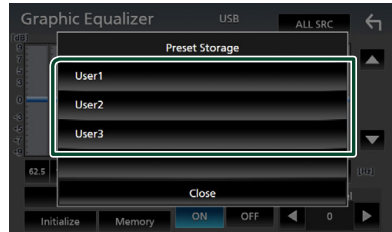

## Volume Offset

Finely adjust the volume of the current source to minimize the difference in volume between different sources.

- 1 Press the **FNC** button.  
➤ FUNCTION screen appears.
- 2 Touch .  
➤ Audio screen appears.
- 3 Touch **Volume Offset**.

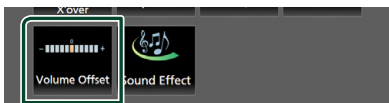

- 4 Touch **+** or **-** to adjust the level.

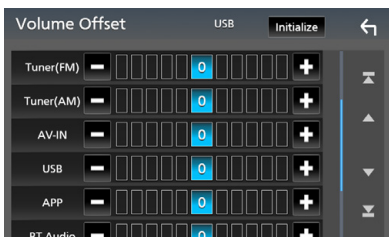

### ■ Initialize

Returns to the initial settings.

\* If you have increased the volume first, then reduced the volume using the "Volume Offset", the sound generated if you suddenly switch to another source may be extremely loud.

## Sound Effect

You can set sound effects.

- 1 Press the **FNC** button.  
➤ FUNCTION screen appears.
- 2 Touch .  
➤ Audio screen appears.
- 3 Touch **Sound Effect**.

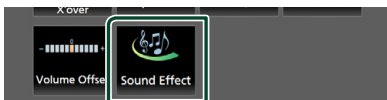

- 4 Set each item as follows.

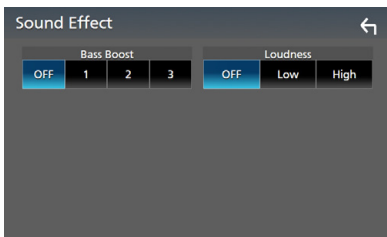

### ■ Bass Boost

Sets the amount of bass boost among "OFF"/"1"/"2"/"3".

### ■ Loudness

Sets the amounts of boost of low and high tones.

"OFF"/"Low"/"High"

## Listening Position/ DTA

Adjust the sound delay time as nearer speakers to the selected seat have more delay time, so that the sound from each speaker arrive a listener at the same time.

- 1 Press the **FNC** button.  
➤ FUNCTION screen appears.

- 2 Touch .  
➤ Audio screen appears.

- 3 Touch **Position/DTA**.

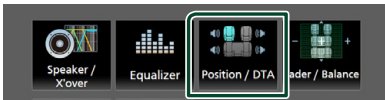

- 4 Select listening position from **Front R** (Right front), **Front L** (Left front), **Front All** (All front), and **All**.

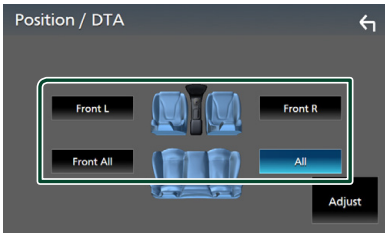

## Position DTA control

You can fine-adjust your listening position.

- 1 Touch **Adjust**.
- 2 Touch **Delay**.
- 3 Touch ◀ or ▶ to adjust the delay time of the selected speaker.



- 4 Touch **Level**.

- 5 Touch ◀ or ▶ to adjust the sound level of the selected speaker.



### NOTE

- To return to the initial setting of Delay and Level, touch **Initialize** and **Yes** in the confirmation screen.

# Remote control

This unit can be operated using the remote control RM-RK258 (optional accessory).

## Functions of the Remote control Buttons

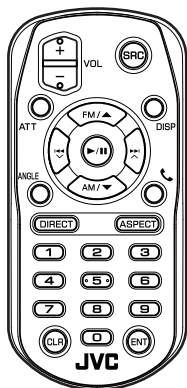

Key Name	Function
<b>SRC</b>	Switches to the source to be played. In hands-free mode, hangs up the phone.
<b>VOL + -</b>	Adjusts the volume.
<b>ATT</b>	Mutes/restores the sound.
<b>DISP</b>	Switches the screen between the current source and the App screen from the connected iPhone/Android.
<b>FM/ ▲ AM/ ▼</b>	During tuner source, select FM/ AM band to be received. For the SiriusXM source, selects the band to be received.
<b>◀◀ ▼ ▶▶ ▲</b>	Selects the track or file to be played. For the tuner and SiriusXM sources, switches to broadcast stations received by the unit.
<b>▶/  </b>	For the tuner, switches the seek mode. For the USB, BT audio, Plays or pauses.
<b>ANGLE</b>	Not used.
<b>☎</b>	When a call comes in, answers the call.
<b>DIRECT</b>	Switches to the direct search mode. For details on the direct search mode, see <b>Direct search mode (P.46)</b> .

Key Name	Function
<b>ASPECT</b>	Changes the aspect ratio.
<b>Numeric Keypad</b>	Specifies the number to search in direct search. For details on the direct search mode, see <b>Direct search mode (P.46)</b> .
<b>CLR</b>	Deletes a character while in direct search mode.
<b>ENT</b>	Performs the selected function.

## Direct search mode

Using the remote control, you can jump directly to the tuner frequency.

### NOTE

- This operation cannot be performed for USB device.

### 1 Press the **SRC** button several times until the desired content appears.

The available contents are different depending on the source type.

■ **Tuner**  
Frequency value

■ **SiriusXM**  
Channel number

### 2 Press the **DIRECT** button.

### 3 Press number buttons to enter a frequency.

### 4 Press the **ENT** button to confirm the entry.

# Connection/Installation

## Before Installation

Before installation of this unit, please note the following precautions.

### ▲ WARNINGS

- If you connect the ignition wire (red) and the battery wire (yellow) to the car chassis (ground), you may cause a short circuit, that in turn may start a fire. Always connect those wires to the power source running through the fuse box.
- Do not cut out the fuse from the ignition wire (red) and the battery wire (yellow). The power supply must be connected to the wires via the fuse.

### ▲ CAUTION

- Install this unit in the console of your vehicle. Do not touch the metal part of this unit during and shortly after the use of the unit. Metal part such as the heat sink and enclosure become hot.

### NOTE

- Mounting and wiring this product requires skills and experience. For best safety, leave the mounting and wiring work to professionals.
- Make sure to ground the unit to a negative 12V DC power supply.
- Do not install the unit in a spot exposed to direct sunlight or excessive heat or humidity. Also avoid places with too much dust or the possibility of water splashing.
- Do not use your own screws. Use only the screws provided. If you use the wrong screws, you could damage the unit.
- If the power is not turned ON ("There is an error in the speaker wiring. Please check the connections." is displayed), the speaker wire may have a short-circuit or touched the chassis of the vehicle and the protection function may have been activated. Therefore, the speaker wire should be checked.
- If your car's ignition does not have an ACC position, connect the ignition wires to a power source that can be turned on and off with the ignition key. If you connect the ignition wire





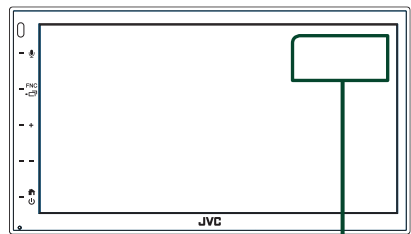

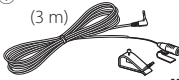

to a power source with a constant voltage supply, such as with battery wires, the battery may be drained.

- If the console has a lid, make sure to install the unit so that the front panel will not hit the lid when closing and opening.
- If the fuse blows, first make sure the wires aren't touching to cause a short circuit, then replace the old fuse with one with the same rating.
- Insulate unconnected wires with vinyl tape or other similar material. To prevent a short circuit, do not remove the caps on the ends of the unconnected wires or the terminals.
- Connect the speaker wires correctly to the terminals to which they correspond. The unit may be damaged or fail to work if you share the ⊖ wires or ground them to any metal part in the car.
- When only two speakers are being connected to the system, connect the connectors either to both the front output terminals or to both the rear output terminals (do not mix front and rear). For example, if you connect the ⊕ connector of the left speaker to a front output terminal, do not connect the ⊖ connector to a rear output terminal.
- After the unit is installed, check whether the brake lamps, blinkers, wipers, etc. on the car are working properly.
- Do not press hard on the panel surface when installing the unit to the vehicle. Otherwise scars, damage, or failure may result.
- Reception may drop if there are metal objects near the Bluetooth antenna.

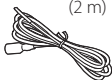

Bluetooth antenna unit

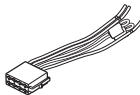
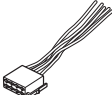
## Supplied accessories for installation

① (3 m)  x1	②  x1
③ (2 m)  x1	④  x1
⑤  (M5 × 6 mm) x6	⑥  (M5 × 8 mm) x6
⑦  x1	⑧  x1
⑨  x2	

## Installation procedure

- 1) To prevent a short circuit, remove the key from the ignition and disconnect the  $\ominus$  terminal of the battery.
- 2) Make the proper input and output wire connections for each unit.
- 3) Connect the wire on the wiring harness.
- 4) Take Connector B (accessory ⑧) on the wiring harness and connect it to the speaker connector in your vehicle.
- 5) Take Connector A (accessory ⑦) on the wiring harness and connect it to the external power connector on your vehicle.
- 6) Connect the wiring harness connector to the unit.
- 7) Install the unit in your car.
- 8) Reconnect the  $\ominus$  terminal of the battery.
- 9) Press the reset button.

## Installing the unit

### Non-Japanese cars

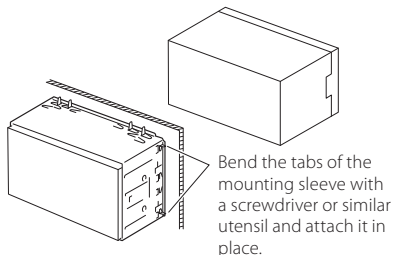

### NOTE

- Make sure that the unit is installed securely in place. If the unit is unstable, it may malfunction (eg, the sound may skip).

### Japanese cars

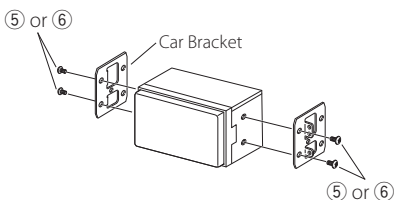

### Trim plate

- 1) Attach accessory ② to the unit.

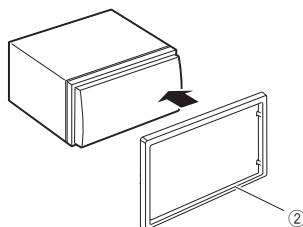



## Microphone unit

- 1) Check the installation position of the microphone (accessory ①).
- 2) Clean the installation surface.
- 3) Remove the separator of the microphone (accessory ①), and stick the microphone to the place shown below.
- 4) Wire the microphone cable up to the unit with it secured at several positions using tape or other desired method.
- 5) Adjust the direction of the microphone (accessory ①) to the driver.

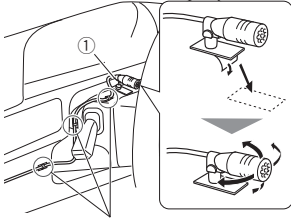

Fix a cable with a commercial item of tape.

### NOTE

- Swap the clips if necessary.

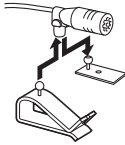

## Removing the trim plate

- 1) Use the extraction key (accessory ④) to lever out the four tabs (two on the left part, two on the right part).

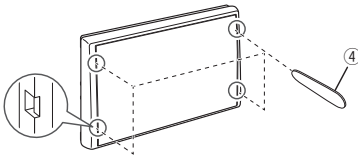

- 2) Pull the trim plate forward.

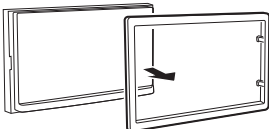

## Removing the unit

- 1) Remove the trim plate by referring to step 1 in "Removing the trim plate".
- 2) Insert the extraction key (accessory ⑨) deeply into the slot as shown. (The protrusion at the tip of the extraction key must face toward the unit.)

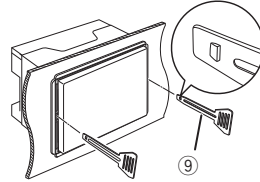

- 3) With the inserted extraction key secured, insert the other extraction key into the slot.

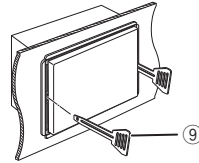

- 4) Pull out the unit halfway.

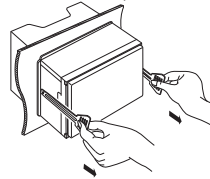

### NOTE

- Be careful to avoid injury from the catch pins on the extraction key.

- 5) Pull the unit all the way out with your hands, being careful not to drop it.

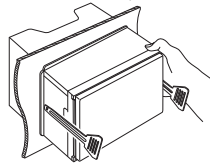

## Connecting wires to terminals

Light Blue/Yellow (Steering remote control wire)

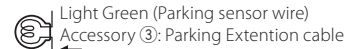
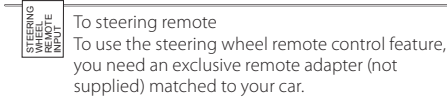

For best safety, be sure to connect the parking sensor.

Purple/White (Reverse sensor wire)

Connect to vehicle's reverse lamp harness when using the optional rear view camera.

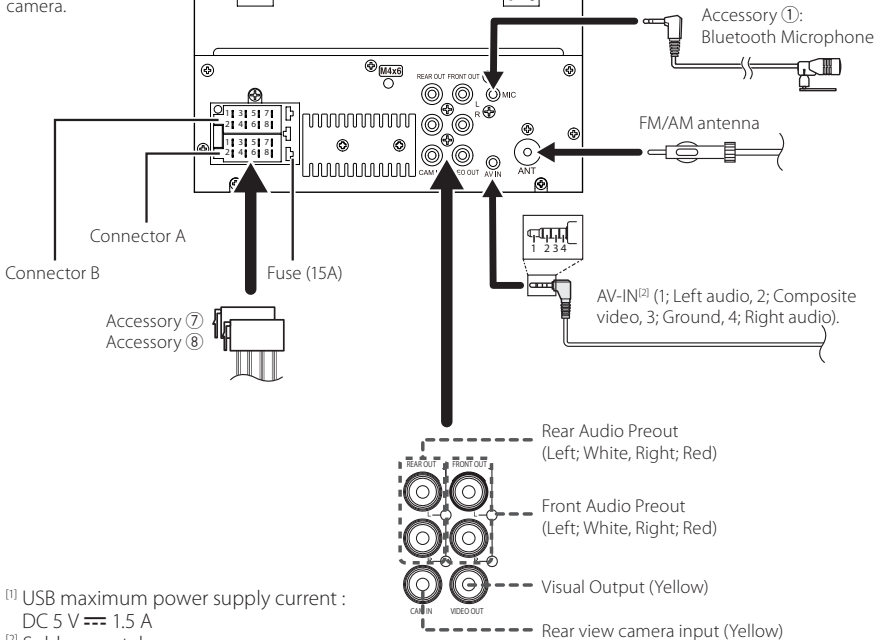

<sup>[1]</sup> USB maximum power supply current : DC 5 V --- 1.5 A

<sup>[2]</sup> Sold separately

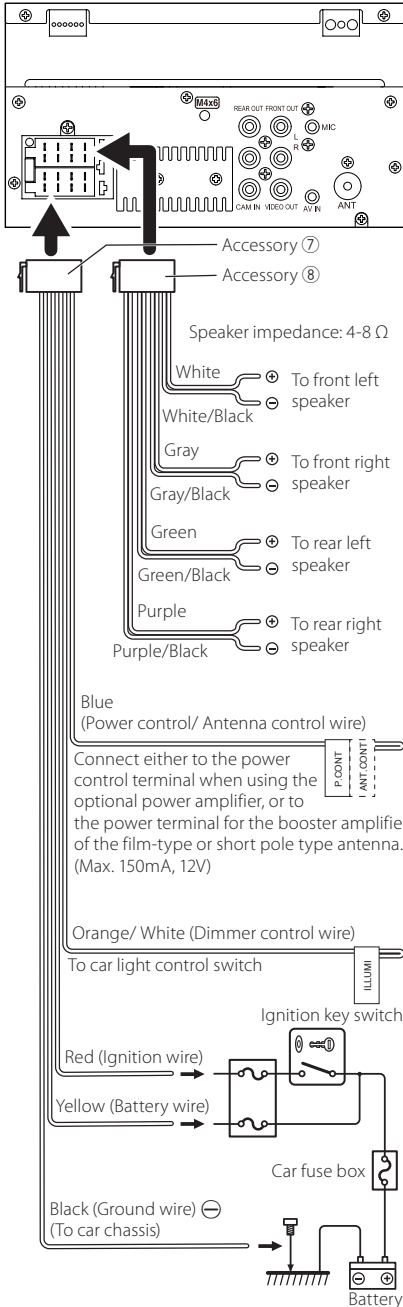

## Connecting an iPhone/Android

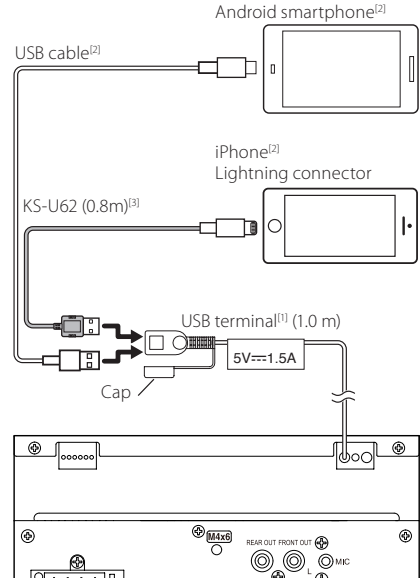

- <sup>[1]</sup> USB maximum power supply current : DC 5 V --- 1.5 A
- <sup>[2]</sup> Sold separately
- <sup>[3]</sup> Optional accessory

# Troubleshooting

## Problems and Solutions

If any trouble occurs, first check the following table for possible problems.

### NOTE

- Some functions of this unit may be disabled by some settings made on this unit.
- What might seem to be a malfunction in your unit may just be the result of slight misoperation or miswiring.

### About settings

- **Cannot set up the subwoofer.**
- **Cannot set up subwoofer phase.**
- **No output from the subwoofer.**
- **Cannot set up the low pass filter.**
- **Cannot set up the high pass filter.**

Subwoofer is not set to on.

- Set the subwoofer to on. See **Speaker/X'over setup (P.41)**.

### About audio operations

#### Radio reception is poor.

The car antenna is not extended.

- Pull out the antenna all the way.

The antenna control wire is not connected.

- Connect the wire correctly. See **Connecting wires to terminals (P.50)**.

#### Cannot select a folder.

The random play function is enabled.

- Turn off the random function.

#### The sound skips when an audio file is being played.

The recording condition is bad.

- Record the file again or use another USB memory.

### Other

#### The Touch Sensor Tone doesn't sound.

The preout jack is being used.

- The Touch Sensor Tone cannot be output from the preout jack.

## Error Messages

When you fail to operate the unit correctly, the cause of the failure appears as the message on the screen.

#### No Device (USB device)

The USB device is selected as a source although no USB device is connected.

- Change the source to any source other than USB. Connect a USB device, and change the source to USB again.

#### Disconnected (Bluetooth audio player)

The Bluetooth audio player is selected as a source although no Bluetooth audio player is connected.

- Change the source to any source other than Bluetooth. Connect an Bluetooth audio player, and change the source to Bluetooth again.

#### No Media file

The connected USB device contains no playable audio file. Media was played that doesn't have data recorded that the unit can play.

- See **Playable Media and Files (P.54)** and try another USB device.

## SiriusXM

---

### Check Tuner

A SiriusXM tuner is not connected to this unit.

- Verify that the SiriusXM Connect Vehicle Tuner cable is securely connected to the radio.

---

### Subscription Updated - Press Return To Continue

The SiriusXM subscription has been renewed.

- Touching [Return] on the popup screen will clear the message.

---

### Channel \*\*\* Not Available

The currently selected channel is unavailable.

- Visit [www.siriusxm.com](http://www.siriusxm.com) for more information about the SiriusXM channel lineup.

---

### Channel \*\*\* Not Subscribed /

#### Call SiriusXM to Subscribe

The currently selected channel is not subscribed to.

- In the U.S.A., visit [www.siriusxm.com](http://www.siriusxm.com) or call 1-866-635-2349 if you have questions about your subscription package or would like to subscribe to this channel.
- In Canada, visit [www.siriusxm.ca](http://www.siriusxm.ca) or call 1-877-438-9677.

---

### Check Antenna

No antenna is connected to the SiriusXM tuner.

- Check that an antenna is connected to the SiriusXM tuner. Check antenna for damages.

---

### No Signal

No SiriusXM radio signal is received.

- Verify that your vehicle is outdoors with a clear view of the sky.

---

### Channel \*\*\* Locked /

#### Please Enter the Lock Code \_ \_ \_ \_

The selected channel has been locked by the parental controls.

- Enter the unlock code when you are asked. See **Parental Control (P.25)**.

---

### Incorrect Pass Code entered

The selected channel is a mature or parental lock channel, and locked by the parental lock or user lock code.

- Enter the correct lock code.

# Appendix

## Playable Media and Files

You can play various kinds of media and files on this unit.

### About files

The following audio and video files are supported.

#### Playable Audio files

	Format	Bit rate	Sampling frequency	Bit count
AAC-LC (.m4a)	MPEG2/4 AAC LC HE-AAC(V1,V2)	8 – 320kbps, VBR	16 – 48 kHz	16 bit
MP3 (.mp3)	MPEG 1/2 Audio Layer 3	8 – 320kbps, VBR	16 – 48 kHz	16 bit
WMA (.wma)	Windows Media Audio Standard L3 profile (Version 7,8,9)	8 – 320kbps	16 – 48 kHz	16 bit
Linear PCM (WAVE) (.wav)	RIFF waveform Audio Format	–	16 – 192 kHz	16/ 24 bit
FLAC (.flac)	flac	–	16 – 192 kHz	16/ 24 bit
Vorbis (.ogg)	vorbis	VBR	16 – 48 kHz	16 bit

#### NOTE

- WMA and AAC of which is covered with DRM cannot be played.
- Although the audio files are complied with the standards listed above, the play may be impossible depending on the types or conditions of media or device.

#### Acceptable Video files

	Profile	Max. Picture size	Max. bit rate	Audio format
MPEG-1 (.mpg, .mpeg)	–	352 × 240, 352 × 288	1.5 Mbps	MPEG Audio Layer 2
MPEG-2 (.mpg, .mpeg)	MP@ML	720 × 480, 720 × 576	8 Mbps	MPEG Audio Layer 2
H.264/MPEG-4 AVC (.mp4, .m4v, .avi, .flv)	Baseline Profile, Main Profile	1920 × 1080 (30 fps)	8 Mbps	MP3, AAC
MPEG-4 (.mp4, .avi)	Advanced Simple Profile	1920 × 1080 (30 fps)	8 Mbps	MP3, AAC
WMV (.wmv)	Main Profile	1920 × 1080 (30 fps)	8 Mbps	WMA
MKV (.mkv)	Video Format follows H.264/MPEG-4 AVC, MPEG-4			MP3, AAC

#### Limitation of structure for the file and the folder

	USB device
Maximum number of folder layers	8
Maximum number of files (per folder)	999
Maximum number of folders (per folder)	9999
Maximum number of folders (per device)	–

#### NOTE

- You can enter a folder name and file name with 255 or fewer single-byte characters.
- Files in the folder whose folder name begins with a dot (.) cannot be played.

## Specifications

### ■ Monitor section

#### Picture Size

- : 6.75 inches (diagonal) wide
- : 151.8 mm (W) × 79.7 mm (H)
- 5-15/16 × 3-1/8 inch

#### Display System

- : Transparent TN LCD panel

#### Drive System

- : TFT active matrix system

#### Number of Pixels

- : 1,152,000 (800H × 480V × RGB)

#### Effective Pixels

- : 99.99%

#### Pixel Arrangement

- : RGB striped arrangement

#### Back Lighting

- : LED

### ■ USB interface section

#### USB Standard

- : USB 2.0 High Speed

#### File System

- : FAT 16/ 32, exFAT

#### Maximum Power Supply Current

- : DC 5 V  1.5 A

#### D/A Converter

- : 16 bit

#### Audio Decoder

- : MP3/ WMA/ AAC/ WAV/ FLAC

#### Video Decoder

- : MPEG1/ MPEG2/ MPEG4/ WMV/ H.264/ MKV

#### Frequency Response

- 192 kHz : 20 – 20,000 Hz
- 96 kHz : 20 – 20,000 Hz
- 48 kHz : 20 – 20,000 Hz
- 44.1 kHz : 20 – 20,000 Hz

#### Total Harmonic Distortion

- : 0.2% (1 kHz)

#### Signal to Noise Ratio

- : 75 dB

#### Dynamic Range

- : 75 dB

### ■ Bluetooth section

#### Technology

- : Bluetooth Ver. 4.1

#### Frequency

- : 2.402 – 2.480 GHz

#### RF Output Power (E.I.R.P.)

- : +8 dBm (Avg.), Power Class 1

#### Maximum Communication range

- : Line of sight approx. 10 m (32.8 ft)

#### Audio Codec

- : SBC/ AAC

#### Profile (Multi Profile support)

- HFP (Hands Free Profile)
- SPP (Serial Port Profile)
- A2DP (Advanced Audio Distribution Profile)
- AVRCP (Audio/Video Remote Control Profile)
- PBAP (Phonebook Access Profile)

### ■ DSP section

#### Graphics equalizer

- Band: 13 Band

- Frequency (BAND1 – 13)

- : 62.5/ 100/ 160/ 250/ 400/ 630/ 1k/ 1.6k/ 2.5k/ 4k/ 6.3k/ 10k/ 16k Hz

#### Gain

- : -9/ -8/ -7/ -6/ -5/ -4/ -3/ -2/ -1/ 0/ +1/ +2/ +3/ +4/ +5/ +6/ +7/ +8/ +9 dB

#### 2Way X'Over

##### High pass filter

- Frequency: Through, 30/ 40/ 50/ 60/ 70/ 80/ 90/ 100/ 120/ 150/ 180/ 220/ 250 Hz

- Slope: -6/ -12/ -18/ -24 dB/ Oct.

- Gain: -8/ -7/ -6/ -5/ -4/ -3/ -2/ -1/ 0 dB

##### Low pass filter

- Frequency: 30/ 40/ 50/ 60/ 70/ 80/ 90/ 100/ 120/ 150/ 180/ 220/ 250 Hz, Through

- Slope: -6/ -12/ -18/ -24 dB/ Oct.

- Gain: -8/ -7/ -6/ -5/ -4/ -3/ -2/ -1/ 0 dB

#### Position

##### Front / Rear /Subwoofer Delay

- : 0 – 20.01 ft (0.03 or 0.04 ft Step)

##### Gain

- : -8 – 0 dB

#### Subwoofer level

- : -40 – +6 dB

## Appendix

### ■ FM tuner section

Frequency Range (step)  
: 87.9 MHz – 107.9 MHz (200 kHz)

Usable Sensitivity (S/N: 30 dB)  
: 16.2 dBf (1.8  $\mu$ V/75  $\Omega$ )

Frequency Response ( $\pm$  3.0 dB)  
: 30 Hz – 14 kHz

S/N (dB)  
: 50 dB (MONO)

Stereo Separation  
: 35 dB (1 kHz)

### ■ AM tuner section

Frequency Range (step)  
: 530 – 1700 kHz (10 kHz)

Usable Sensitivity  
: 99  $\mu$ V (40 dB $\mu$ )

### ■ Video section

Color System of External Video Input  
: NTSC/ PAL

External Video Input Level (Mini jack)  
: 1 Vp-p/ 75  $\Omega$

External Audio Max Input Level (RCA jack)  
: 1.5 V/ 25 k $\Omega$

Video Output Level (RCA jacks)  
: 1 Vp-p/ 75  $\Omega$

### ■ Audio section

Maximum Power Output (Front & Rear)  
: 45 W  $\times$  4

Full Bandwidth Power (at less than 1% THD)  
: 21 W  $\times$  4

Output Frequency Band  
: 20 – 20,000 Hz

Preout Level (V)  
: 2 V/ 10 k $\Omega$

Preout Impedance  
: 1.4 k $\Omega$

Speaker Impedance  
: 4 – 8  $\Omega$

### ■ General

Operating Voltage  
: 12V DC Car Battery

Installation Dimensions (W  $\times$  H  $\times$  D)  
: 182  $\times$  112  $\times$  75 mm  
7-3/16  $\times$  4-7/16  $\times$  2-15/16 inch

Main Unit Installation size (W  $\times$  H  $\times$  D)  
: 178  $\times$  100  $\times$  75 mm (w/o sleeve)  
7  $\times$  3-15/16  $\times$  2-15/16 inch

Weight  
: 1.3 kg (2.8 lbs)  
(Including Sleeve and Trim plate)

#### NOTE

- Although the effective pixels for the liquid crystal panel is given as 99.99% or more, 0.01% of pixels may not light or may light incorrectly.

**Specifications subject to change without notice.**



## About this Unit

### ■ Copyrights

- The Bluetooth® word mark and logos are registered trademarks owned by Bluetooth SIG, Inc. and any use of such marks by JVCKENWOOD Corporation is under license. Other trademarks and trade names are those of their respective owners.
- Windows Media is a registered trademark or trademark of Microsoft Corporation in the United States and/or other countries.
- This product is protected by certain intellectual property rights of Microsoft. Use or distribution of such technology outside of this product is prohibited without a license from Microsoft.
- Use of the Made for Apple badge means that an accessory has been designed to connect specifically to the Apple product(s) identified in the badge, and has been certified by the developer to meet Apple performance standards. Apple is not responsible for the operation of this device or its compliance with safety and regulatory standards. Please note that the use of this accessory with an Apple product may affect wireless performance.
- Apple, iPhone and Lightning are trademarks of Apple Inc., registered in the U.S. and other countries.
- Apple, Siri, Apple CarPlay and Apple CarPlay logo are trademarks of Apple Inc., registered in the U.S. and other countries.
- App Store is a service mark of Apple Inc., registered in the U.S. and other countries.
- Sirius, XM and all related marks and logos are trademarks of Sirius XM Radio Inc. All rights reserved.
- IOS is a trademark or registered trademark of Cisco in the U.S. and other countries and is used under license.
- Google, Android, Google Play and Android Auto are trademarks of Google LLC.
- To use Android Auto on your car display, you'll need an Android Auto compatible vehicle or aftermarket stereo, an Android phone running Android 5.0 or higher, and the Android Auto app.
- Linux® is the registered trademark of Linus Torvalds in the U.S. and other countries.
- THIS PRODUCT IS LICENSED UNDER THE AVC PATENT PORTFOLIO LICENSE FOR THE PERSONAL USE OF A CONSUMER OR OTHER USES IN WHICH IT DOES NOT RECEIVE REMUNERATION TO (i) ENCODE VIDEO IN COMPLIANCE WITH THE AVC STANDARD ("AVC VIDEO") AND/OR (ii) DECODE AVC VIDEO THAT WAS ENCODED BY A CONSUMER ENGAGED IN A PERSONAL ACTIVITY AND/OR WAS OBTAINED FROM A VIDEO PROVIDER LICENSED TO PROVIDE AVC VIDEO. NO LICENSE IS GRANTED OR SHALL BE IMPLIED FOR ANY OTHER USE. ADDITIONAL INFORMATION MAY BE OBTAINED FROM MPEG LA, L.L.C. SEE [HTTP://WWW.MPEGLA.COM](http://www.MPEGLA.COM)
- THIS PRODUCT IS LICENSED UNDER THE MPEG-4 VISUAL PATENT PORTFOLIO LICENSE FOR THE PERSONAL AND NON-COMMERCIAL USE OF A CONSUMER FOR (j) ENCODING VIDEO IN COMPLIANCE WITH THE MPEG-4 VISUAL STANDARD ("MPEG-4 VIDEO") AND/

OR (ij) DECODING MPEG-4 VIDEO THAT WAS ENCODED BY A CONSUMER ENGAGED IN A PERSONAL AND NON-COMMERCIAL ACTIVITY AND/OR WAS OBTAINED FROM A VIDEO PROVIDER LICENSED BY MPEG LA TO PROVIDE MPEG-4 VIDEO. NO LICENSE IS GRANTED OR SHALL BE IMPLIED FOR ANY OTHER USE. ADDITIONAL INFORMATION INCLUDING THAT RELATING TO PROMOTIONAL, INTERNAL AND COMMERCIAL USES AND LICENSING MAY BE OBTAINED FROM MPEG LA, L.L.C. SEE [HTTP://WWW.MPEGLA.COM](http://www.MPEGLA.COM).

- THIS PRODUCT IS LICENSED UNDER THE VC-1 PATENT PORTFOLIO LICENSE FOR THE PERSONAL AND NON-COMMERCIAL USE OF A CONSUMER TO (i) ENCODE VIDEO IN COMPLIANCE WITH THE VC-1 STANDARD ("VC-1 VIDEO") AND/OR (ii) DECODE VC-1 VIDEO THAT WAS ENCODED BY A CONSUMER ENGAGED IN A PERSONAL AND NON-COMMERCIAL ACTIVITY AND/OR WAS OBTAINED FROM A VIDEO PROVIDER LICENSED TO PROVIDE VC-1 VIDEO. NO LICENSE IS GRANTED OR SHALL BE IMPLIED FOR ANY OTHER USE. ADDITIONAL INFORMATION MAY BE OBTAINED FROM MPEG LA, L.L.C. SEE [HTTP://WWW.MPEGLA.COM](http://www.MPEGLA.COM)

#### • libFLAC

Copyright (C) 2000,2001,2002,2003,2004,2005,2006,2007,2008,2009 Josh Coalsoun

Redistribution and use in source and binary forms, with or without modification, are permitted provided that the following conditions are met:

- Redistributions of source code must retain the above copyright notice, this list of conditions and the following disclaimer.
- Redistributions in binary form must reproduce the above copyright notice, this list of conditions and the following disclaimer in the documentation and/or other materials provided with the distribution.
- Neither the name of the Xiph.org Foundation nor the names of its contributors may be used to endorse or promote products derived from this software without specific prior written permission.

THIS SOFTWARE IS PROVIDED BY THE COPYRIGHT HOLDERS AND CONTRIBUTORS "AS IS" AND ANY WARRANTIES OR IMPLIED WARRANTIES, INCLUDING, BUT NOT LIMITED TO, THE IMPLIED WARRANTIES OF MERCHANTABILITY AND FITNESS FOR A PARTICULAR PURPOSE ARE DISCLAIMED. IN NO EVENT SHALL THE FOUNDATION OR CONTRIBUTORS BE LIABLE FOR ANY DIRECT, INDIRECT, INCIDENTAL, SPECIAL, EXEMPLARY, OR CONSEQUENTIAL DAMAGES (INCLUDING, BUT NOT LIMITED TO, PROCUREMENT OF SUBSTITUTE GOODS OR SERVICES; LOSS OF USE, DATA, OR PROFITS; OR BUSINESS INTERRUPTION) HOWEVER CAUSED AND ON ANY THEORY OF LIABILITY, WHETHER IN CONTRACT, STRICT LIABILITY, OR TORT (INCLUDING NEGLIGENCE OR OTHERWISE) ARISING IN ANY WAY OUT OF THE USE OF THIS SOFTWARE, EVEN IF ADVISED OF THE POSSIBILITY OF SUCH DAMAGE.

#### • libvorbis

Copyright (c) 2002-2008 Xiph.org Foundation

Redistribution and use in source and binary forms, with or without modification, are permitted provided that the following conditions are met:

- Redistributions of source code must retain the above copyright notice, this list of conditions and the following disclaimer.

## Appendix

- Redistributions in binary form must reproduce the above copyright notice, this list of conditions and the following disclaimer in the documentation and/or other materials provided with the distribution.
- Neither the name of the Xiph.org Foundation nor the names of its contributors may be used to endorse or promote products derived from this software without specific prior written permission.

THIS SOFTWARE IS PROVIDED BY THE COPYRIGHT HOLDERS AND CONTRIBUTORS "AS IS" AND ANY EXPRESS OR IMPLIED WARRANTIES, INCLUDING, BUT NOT LIMITED TO, THE IMPLIED WARRANTIES OF MERCHANTABILITY AND FITNESS FOR A PARTICULAR PURPOSE ARE DISCLAIMED. IN NO EVENT SHALL THE FOUNDATION OR CONTRIBUTORS BE LIABLE FOR ANY DIRECT, INDIRECT, INCIDENTAL, SPECIAL, EXEMPLARY, OR CONSEQUENTIAL DAMAGES (INCLUDING, BUT NOT LIMITED TO, PROCUREMENT OF SUBSTITUTE GOODS OR SERVICES; LOSS OF USE, DATA, OR PROFITS; OR BUSINESS INTERRUPTION) HOWEVER CAUSED AND ON ANY THEORY OF LIABILITY, WHETHER IN CONTRACT, STRICT LIABILITY, OR TORT (INCLUDING NEGLIGENCE OR OTHERWISE) ARISING IN ANY WAY OUT OF THE USE OF THIS SOFTWARE, EVEN IF ADVISED OF THE POSSIBILITY OF SUCH DAMAGE.

- libogg

Copyright (c) 2002, Xiph.org Foundation Redistribution and use in source and binary forms, with or without modification, are permitted provided that the following conditions are met:

- Redistributions of source code must retain the above copyright notice, this list of conditions and the following disclaimer.
- Redistributions in binary form must reproduce the above copyright notice, this list of conditions and the following disclaimer in the documentation and/or other materials provided with the distribution.
- Neither the name of the Xiph.org Foundation nor the names of its contributors may be used to endorse or promote products derived from this software without specific prior written permission.

THIS SOFTWARE IS PROVIDED BY THE COPYRIGHT HOLDERS AND CONTRIBUTORS "AS IS" AND ANY EXPRESS OR IMPLIED WARRANTIES, INCLUDING, BUT NOT LIMITED TO, THE IMPLIED WARRANTIES OF MERCHANTABILITY AND FITNESS FOR A PARTICULAR PURPOSE ARE DISCLAIMED. IN NO EVENT SHALL THE FOUNDATION OR CONTRIBUTORS BE LIABLE FOR ANY DIRECT, INDIRECT, INCIDENTAL, SPECIAL, EXEMPLARY, OR CONSEQUENTIAL DAMAGES (INCLUDING, BUT NOT LIMITED TO, PROCUREMENT OF SUBSTITUTE GOODS OR SERVICES; LOSS OF USE, DATA, OR PROFITS; OR BUSINESS INTERRUPTION) HOWEVER CAUSED AND ON ANY THEORY OF LIABILITY, WHETHER IN CONTRACT, STRICT LIABILITY, OR TORT (INCLUDING NEGLIGENCE OR OTHERWISE) ARISING IN ANY WAY OUT OF THE USE OF THIS SOFTWARE, EVEN IF ADVISED OF THE POSSIBILITY OF SUCH DAMAGE.

## ■ FCC CAUTION

Changes or modifications not expressly approved by the party responsible for compliance could void the user's authority to operate the equipment.

### NOTE

- This equipment has been tested and found to comply with the limits for a Class B digital device, pursuant to part 15 of the FCC Rules. These limits are designed to provide reasonable protection against harmful interference in a residential installation.
- This equipment generates, uses and can radiate radio frequency energy and, if not installed and used in accordance with the instructions, may cause harmful interference to radio communications. However, there is no guarantee that interference will not occur in a particular installation. If this equipment does cause harmful interference to radio or television reception, which can be determined by turning the equipment off and on, the user is encouraged to try to correct the interference by one or more of the following measures:
  - Reorient or relocate the receiving antenna.
  - Increase the separation between the equipment and receiver.
  - Connect the equipment into an outlet on a circuit different from that to which the receiver is connected.
  - Consult the dealer or an experienced radio/TV technician for help.

This transmitter must not be co-located or operated in conjunction with any other antenna or transmitter.

### ■ ISED CAUTION

This device contains licence-exempt transmitter(s)/ receiver(s) that comply with Innovation, Science and Economic Development Canada's licence-exempt RSS(s).

Operation is subject to the following two conditions:

- (1) This device may not cause interference.
- (2) This device must accept any interference, including interference that may cause undesired operation of the device.

### ▲ CAUTION

This equipment complies with FCC/ISED radiation exposure limits set forth for an uncontrolled environment and meets the FCC radio frequency (RF) Exposure Guidelines and RSS-102 of the ISED radio frequency (RF) Exposure rules. This equipment should be installed and operated keeping the radiator at least 20cm or more away from person's body.

#### Supplier's Declaration of Conformity

Trade Name: JVC  
 Products: MONITOR WITH RECEIVER  
 Model Name: KW-M560BT / KW-M56BT  
 Responsible Party: JVCKENWOOD USA CORPORATION  
 2201 East Dominguez Street,  
 Long Beach, CA 90810, U.S.A.  
 PHONE: 310 639-9000

THIS DEVICE COMPLIES WITH PART 15 OF THE FCC RULES. OPERATION IS SUBJECT TO THE FOLLOWING TWO CONDITIONS:

- (1) THIS DEVICE MAY NOT CAUSE HARMFUL INTERFERENCE, AND
- (2) THIS DEVICE MUST ACCEPT ANY INTERFERENCE RECEIVED, INCLUDING INTERFERENCE THAT MAY CAUSE UNDESIRE OPERATION.

### ■ Información acerca de la eliminación de equipos eléctricos y electrónicos al final de la vida útil (aplicable a los países que hayan adoptado sistemas independientes de recogida de residuos)



Los productos con el símbolo de un contenedor con ruedas tachado no podrán ser desechados como residuos domésticos.

Los equipos eléctricos y electrónicos al final de la vida útil, deberán ser reciclados en instalaciones que puedan dar el tratamiento adecuado a estos productos y a sus subproductos residuales correspondientes. Póngase en contacto con su administración local para obtener información sobre el punto de recogida más cercano. Un tratamiento correcto del reciclaje y la eliminación de residuos ayuda a conservar los recursos y evita al mismo tiempo efectos perjudiciales en la salud y el medio ambiente.

### ■ Informação sobre a eliminação de pilhas

Este produto não deve ser eliminado como lixo doméstico geral. Devolva a pilha usada ao revendedor ou entidade autorizada para que a mesma seja devolvida ao fabricante ou importador.

A reciclagem e a eliminação de lixo de maneira apropriada ajudarão a conservar os recursos naturais ao mesmo tempo que prevenirão os efeitos prejudiciais à nossa saúde e ao meio ambiente.

### ■ Para cumplimiento de la IFT:

"La operación de este equipo esta sujeta a las siguientes dos condiciones:

- (1) es posible que este equipo o dispositivo no cause interferencia perjudicial y
- (2) este equipo o dispositivo debe aceptar cualquier interferencia, incluyendo la que pueda causar su operación no deseada."

## Important Notice on Software

### Software License on This Product

The software embedded in this product comprises a number of independent software components, each of which is copyrighted by JVCKENWOOD Corporation or by a third party.

This product uses software components that are based on an End-User License Agreement (hereinafter called "EULA") stipulated by JVCKENWOOD Corporation and by third parties.

The EULA dictates the availability of the source codes of free-software components as a prerequisite to distributing them in executable form under the terms of the GNU General Public License or the Lesser General Public License (hereinafter called "GPL/LGPL"). To get information about the software components that are subject to the terms of the GPL/LGPL, please visit the following Website:

Website URL  
<https://www3.jvckenwood.com/english/download/gpl/>

Queries concerning the contents of the source code or the like will not be accepted.

Please note that software components based on a EULA that is not subject to the terms of the GPL/LGPL or those that have been developed or created by JVCKENWOOD Corporation will be excluded from the scope of source code disclosure.

Because licenses to use software components distributed under the GPL/LGPL are offered to the customers for free of charge, no warranty is granted to the customers, whether explicitly or implicitly, to the extent of the applicable laws.

Unless otherwise stipulated by the applicable laws or agreed upon in writing, the copyright holders or those who are entitled to modify and redistribute the software components are not held responsible for any and all damages resulting from their use or from inability to use them. For more information about the terms of use of the software components, required items of compliance and so on, please refer to the GPL/LGPL.

Customers wishing themselves to use a software component that is subject to the GPL/LGPL embedded in this product are encouraged to read the terms of the corresponding license before use. Because each individual license is prescribed by a third party other than JVCKENWOOD Corporation, the original (English) of the license is presented.

## EULA

### Software License Agreement

JVCKENWOOD Corporation (hereinafter called "Licensor") holds either the copyright to the embedded software or the right to sublicense it. This agreement establishes the conditions under which the customer uses this "Licensed Software."

The customer shall agree to the terms of this license agreement before proceeding to use Licensed Software.

This agreement is deemed to have taken effect when the customer (hereinafter called "User") has used a product implementation of Licensed Software.

The Licensed Software may contain software Licensor has been licensed to use by third parties directly or indirectly. Some third parties may have terms of use prescribed for their customers, apart from this Software License Agreement. This agreement does not apply to such software. Be sure to consult "Important Notice on Software" as presented separately.

#### Article 1 (General)

Licensor grants to User a non-exclusive, non-assignable right of use Licensed Software within the country where the User purchases the Product (hereinafter the "Country") (except for the exception provided for in Paragraph 1, Article 3).

#### Article 2 (Right of Use)

1. The rise of use granted under this agreement is the right to use Licensed Software in this product.
2. User may not duplicate, copy, modify, add to, translate or otherwise alter, or loan licensed Software and the associated literature in whole or in part.
3. Use of Licensed Software is limited to a private extent, and Licensed Software may not be distributed, licensed or sublicensed for any purposes whatsoever, including commercial use.
4. User shall use Licensed Software as per the instruction manual or instructions given in the help file and may not use or duplicate data in violations of the regulations of the Copyright Law or other governing laws by using Licensed Software in whole or in part.

### **Article 3 (Terms of License)**

1. In assigning this product, User may not retain the original copy of the embedded Licensed Software (including associated literature, updates and upgrades) and any duplicates and associated literature with regard to the license to use Licensed Software. User may transfer Licensed Software only to the condition of binding the assignee to abide by the terms of this Software License Agreement.
2. User may not reverse-engineer, disassemble, decompile or otherwise analyze the source code of Licensed Software.

### **Article 4 (Rights to Licensed Software)**

All rights to Licensed Software and the associated literature, including copyrights, shall reside with Licensor or the original right holder who has granted the Right of Use and right to sublicense to Licensor (hereinafter referred to as "Original Right Holder"), and User does not have any rights other than Right of Use granted hereunder with regard to Licensed Software and the associated literature.

### **Article 5 (Exemption Granted to Licensor)**

1. Licensor and Original Right Holder do not assume any responsibility for damages caused to User or third parties resulting from the exercise by User of the license granted hereunder, unless otherwise provided by any law to the contrary.
2. Licensor does not warrant Licensed Software to be merchantable, compatible and fit for specific purposes.

### **Article 6 (Responsibility for Third Parties)**

If disputes over the infringement of third parties' intellectual property rights, such as copyrights and patent rights, arise out of the use of Licensed Software by User, User shall resolve these disputes at User's own expenses while keep Licensor and Original Right Holder harmless.

### **Article 7 (Secrecy Obligation)**

User shall keep confidential Licensed Software provided hereunder, information contained in the associated literature or the like and those provisions of this agreement not yet in public knowledge and may not disclose or leak these to third parties without prior written consent from Licensor.

### **Article 8 (Cancellation of the Agreement)**

Licensor reserves the right to cancel this agreement forthwith and claim compensation from User for the damages caused by such cancellation when User:

- (1) Breaches any of the provisions of this agreement, or
- (2) Has received a petition for seizure, provisional seizure, provisional disposition or any other kind of compulsory execution.

### **Article 9 (Destruction of Licensed Software)**

If this agreement is terminated under the provision of the foregoing paragraph, User shall destroy Licensed Software, along with all associated literature and its duplicates, within two (2) weeks from the date of termination.

### **Article 10 (Copyright Protection)**

1. Copyrights and all other intellectual property rights relating to Licensed Software shall reside with Licensor and Original Right Holder and in no circumstances with User.
2. User shall abide by the laws relating to copyrights and intellectual property rights in using Licensed Software.

### **Article 11 (Export Control)**

1. Licensed Software and the associated literature or the like may not be exported to places outside the Country (including transmission outside the Country over the Internet or the like).
2. User agrees that Licensed Software is subject to export controls imposed by the Country and the United States of America.
3. User agrees to comply with all the international and domestic laws that apply to this software (U.S. Export Administration Regulations and regulations established by the U.S., the Country and their governmental agencies regarding usage by end users and export destinations).

### **Article 12 (Miscellaneous)**

1. Even if this agreement is invalidated in part by law, all other provisions shall remain in effect.
2. Licensor and User shall consult each other in good faith to resolve any matters not provided for in this agreement or questions arising from the interpretation of this agreement.
3. Licensor and User agree that this agreement is governed by the law of Japan and that all disputes involving claims and obligations that may arise out of this agreement will be settled by arbitration at the Tokyo District Court as the court of first instance.

**JVC**