



KW-M27DBT

MONITOR WITH RECEIVER

INSTRUCTION MANUAL

JVCKENWOOD Corporation

- Updated information (the latest Instruction Manual, etc.) is available from <https://www.jvc.net/cs/car/>.

Model name indication position

See "Removing the trim plate" (P.25)

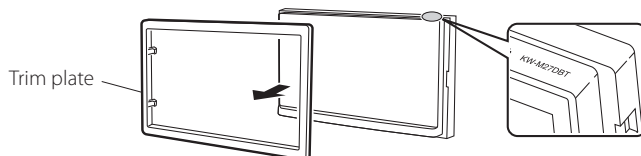

Contents

Before use	2
How to read this manual	2
Precautions	2
Getting Started	3
Clock settings	3
Basics	4
Functions of the Buttons on the Front Panel	4
Common operations	4
HOME screen descriptions	5
List screen	5
Digital Radio	6
Digital Radio Basic Operation	6
Digital Radio Setup	7
Tuner	8
Tuner Basic Operation	8
Tuner Setup	9
USB	10
Preparation	10
Playback operations	10
iPod/iPhone	12
Preparation	12
Playback operations	12
Mirroring	14
Preparation	14
Mirroring operations	14
External Components	15
Using external audio/video players	15
Rear view camera	15
Bluetooth	17
Register your smartphone to the unit	17
Bluetooth Setup	17
Receive a phone call	18
Make a phone call	18
Playing Bluetooth Audio Device	19
Controlling Audio	20
Controlling General Audio	20
Equalizer Control	20
Speaker / X'Over setup	21
Listening Position / DTA	21
Sound Effect	21
Remote control	22
Functions of the Remote control Buttons	22
Installation	23
Before Installation	23
Installing the unit	24
About this Unit	28
More information	28
Troubleshooting	28
Specifications	30
Copyrights	32

How to read this manual

- The panels shown in this guide are examples used to provide clear explanations of the operations. For this reason, they may be different from the actual panels.
- In operation procedures, bracket shape indicates the key or button you should control.
 - < >: indicates the name of panel buttons.
 - []: indicates the name of touch keys

Before use

Precautions

▲WARNING

■ To prevent injury or fire, take the following precautions:

- To prevent a short circuit, never put or leave any metallic objects (such as coins or metal tools) inside the unit.
- Do not watch or fix your eyes on the unit's display when you are driving for any extended period.
- If you experience problems during installation, consult your JVC dealer.

■ Precautions on using this unit

- When you purchase optional accessories, check with your JVC dealer to make sure that they work with your model and in your area.
- The Radio Data System or Radio Broadcast Data System feature won't work where the service is not supported by any broadcasting station.

■ Protecting the monitor

- To protect the monitor from damage, do not operate the monitor using a ballpoint pen or similar tool with the sharp tip.

■ Cleaning the Unit

If the front panel of this unit is stained, wipe it with a dry soft cloth such as a silicon cloth. If the front panel is stained badly, wipe the stain off with a cloth moistened with neutral cleaner, then wipe it again with a clean soft dry cloth.

▲ CAUTION

- Applying spray cleaner directly to the unit may affect its mechanical parts. Wiping the front panel with a hard cloth or using a volatile liquid such as thinner or alcohol may scratch the surface or erase screened print.

■ How to reset your unit

If the unit or the connected unit fails to operate properly, reset the unit.

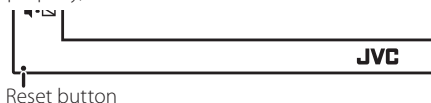

This symbol on the product means there are important operating and maintenance instructions in this manual.

Be sure to carefully read instructions in this manual.

Getting Started

1 Turn the ignition key of your car to ACC.

The unit is turned on.

2 Press the <🏠> button.

3 Touch [⚙️].



4 Touch the corresponding key and set the value.

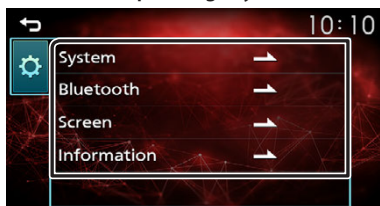

[System]

[Beep Tone]

Activates or deactivates the key-touch tone.
"ON" (Default), "OFF"

[Language]

Select the language used for the control screen and setting items. Default is "English".

[Time/Date]

Adjust the clock time. **(P.3)**

[Clock Mode]

Select the time display format.
[12hr] / [24hr] (Default)

[Parking Guidelines]

You can display parking guidelines to enable easier parking when you shift the gear to the reverse (R) position. Default is "ON".

[Guidelines SETUP]

If you select [ON] for [Parking Guidelines], you can adjust the parking guidelines. See **To adjust the parking guidelines (P.16)**.

[System Reset]

Touch [System Reset] and then touch [YES] to set all the settings to the initial default settings.

[Bluetooth]

Displays the Bluetooth Settings screen. **(P.17)**

[Screen]

[Dimmer]

Select the dimmer mode.
"High" (Default) / "Mid" / "Low"

[Demo]

Select the demonstration mode. Default is "ON".

[Information]

Displays the software version of this unit.

5 Touch [↵].

Clock settings

■ Synchronizing the clock time with FM RDS

Activate [RDS Clock Sync].
See **Tuner Setup (P.9)**.

■ Adjusting the clock manually

📌 NOTE

- Deactivate [RDS Clock Sync] before adjusting the clock.

1 Press the <🏠> button.

2 Touch [⚙️].

3 Touch [System].

4 Touch [Time/Date].

Clock screen appears.

5 Touch [▲] or [▼] to set the clock time.



6 Touch [↵].

Basics

Functions of the Buttons on the Front Panel

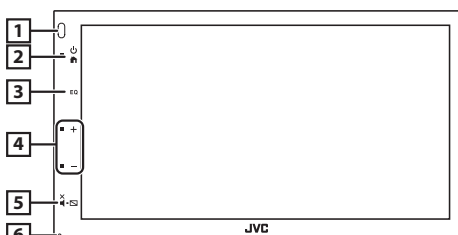

1 Remote Sensor

- Receives the remote control signal.

2 (HOME)

- Displays the HOME screen. **(P.5)**
- Pressing for 1 second turns the power off.
- When the power off, turns the power on.

3 EQ

- Displays the Audio screen.* **(P.20)**
- * The Audio screen is not displayed during SETUP screen or on the list screen etc.

4 +, - (Volume)

- Adjusts volume. The volume will go up until 20 when you keep pressing [+].

5 (MUTE, Display off)

- Mutes/restores the sound.
- Pressing for 1 second turns the screen off. When the screen is off, touch the display to turn on the screen.

6 Reset

- If the unit or the connected unit fails to operate properly, the unit returns to factory settings when this button is pressed.

Common operations

Turning on the power

- 1 Press the  button.



Turning off the power

- 1 Press and hold the  button.



Adjusting the volume

- 1 Press the <+> or <-> button.

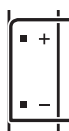

NOTE

- The volume will go up until 20 when you keep pressing [+].

Mutes the sound

- 1 Press the  button.



- To restore the sound, touch the button again, or adjust the volume.

Turn off the screen

- 1 Press and hold the  button.



- To turn on the screen, touch the display.

Basics



HOME screen descriptions

1 Press the  button.



HOME screen appears.



- 1 Clock display
Touch to displays the Clock screen.
- 2 Switches to the Tuner broadcast. **(P.8)**
- 3 **[USB]** 
Plays files on a USB device. **(P.10)**
[iPod] 
Plays an iPod/iPhone. **(P.12)**
 - When iPod/iPhone is connected.**[Mirroring]** 
Displays the Mirroring screen. **(P.14)**
 - When android device with "Mirroring OB for JVC" application installed is connected.
- 4 Switches to an external component connected to the AV-IN input terminal. **(P.15)**
- 5 Displays the Hands Free screen. **(P.18)**
- 6 Plays a Bluetooth audio player. **(P.19)**
- 7 Switches to the digital radio broadcast. **(P.6)**
- 8 Displays the SETUP screen. **(P.3)**

List screen

There are some common function keys in the list screens of most sources.

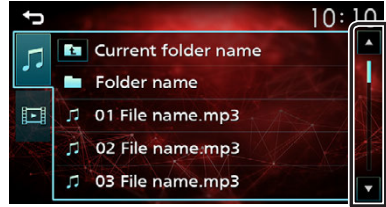

1 You can change the page to display more items by pressing **[▲]**/**[▼]**.

Digital Radio

Digital Radio Basic Operation

1 Press the button.

2 Touch [Digital Radio].

Source control screen



1 Displays the information of the current service: Service name, Ensemble name, PTY Genre, Channel

2 **[DAB]**: Switches the Digital Radio preset band. "DAB1", "DAB2", "DAB3"

[DLS]: Display the Dynamic Label Segment screen

[]: Select an ensemble, service, and component.

[]: Displays the Digital Radio Setup screen. (P.7)

3 Recalls the memorized service. When touched for 2 seconds, stores the current receiving service in memory.

4 **[]**: Returns to previous screen.

[]: Displays the Audio screen. (P.20)

Store a services

You can store the current receiving service in memory.

1 Tune in to a service you want to preset.

2 Touch and hold [#] (#:1-5) in which you want to store the service.

Select a stored service

1 Touch [#] (#:1-5).

Search by program type

1 Touch [****].

2 Touch [PTY].

3 Select a program type from the list. PTY Search starts.

Digital Radio

Digital Radio Setup

1 Touch [☰].

2 Set each item as follows.

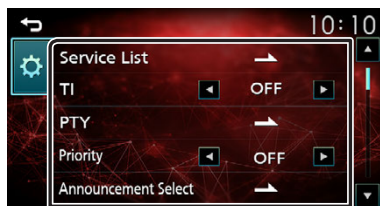

[Service List]

Displays the Service List screen.

- [☰]: Touch and then touch [Yes] to find the latest service list.

[TI]

Switches to the traffic information automatically when the traffic bulletin starts.

"ON", "OFF" (Default)

[PTY]

Searches for a program by program type.

[Priority]

If the same service is provided by Radio Data System when reception of the service being provided by Digital Radio becomes poor, automatically switches to Radio Data System.

"ON", "OFF" (Default)

[Announcement Select]

Switches to the set Announcement service.

[Related Service]

When you select ON, the unit switches to a related service (if exists) when a DAB service network is not available. Default is "OFF".

[Antenna Power]

Sets power supply to the Digital Radio antenna. Set to "ON" when the Digital Radio antenna in use is equipped with a booster. Default is "ON".

3 Touch [↩].

Announcement setup

When the service for which ON is selected starts, switches from any source to Announcement to receive it.

1 Touch [Announcement Select] in the DAB SETUP screen.

2 Touch each Announcement list and set on or off.



Tuner

Tuner Basic Operation

1 Press the <Home> button.

2 Touch [Tuner].

Source control screen

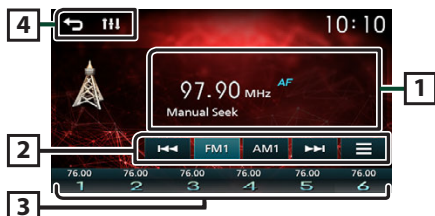

1 Displays the information of the current station:
PS name, Frequency, PTY Genre, Indicator Items

2 **[FM]** : Switches the FM band.

"FM1", "FM2", "FM3"

[AM] : Switches the AM band.

"AM1", "AM2"

[◀▶] : Tunes in a station with good reception automatically.

[☰] : Displays the Tuner Setup screen. **(P.9)**

3 Recalls the memorized station.

When touched for 2 seconds, stores the current receiving station in memory.

4 **[◀]** : Returns to previous screen.

[🔊] : Displays the Audio screen. **(P.20)**

Auto memory

You can preset 6 stations for the current band (FM1/FM2/FM3/AM1/AM2).

1 Touch **[FM]** or **[AM]** to select the band.

2 Touch **[☰]**.

3 Touch **[Auto Store]**.

The local stations with the strongest signals are found and stored automatically.

Manual memory

You can store the current receiving station in memory.

1 Tune in to a station you want to preset.

2 Touch and hold **[#]** (#:1-6) in which you want to store the station.

Recalling the preset station

1 Touch **[#]** (#:1-6).

Search by program type

1 Touch **[☰]**.

2 Touch **[RDS]**.

3 Touch **[◀]** or **[▶]** of **[PTY]** to select a program type.

4 Touch **[PTY Seek]**.

PTY Search starts

Tuner

Tuner Setup

1 Touch [≡].

2 Set each item as follows.

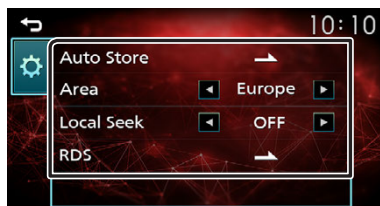

[Auto Store]

Automatically searches and stores the 6 stations with the strongest signals for the selected band.

"Auto Store" appears.

[Area]

"Europe": For Europe, AM/FM intervals: 9 kHz/50 kHz.

[Local Seek]

Tunes in only to the stations with sufficient signal strength. (**LOC** indicator lights up.)

"ON", "OFF" (Default)

[RDS] *1

Displays the RDS Settings screen.

[AF]

When station reception is poor, automatically switches to the station that is broadcasting the same program over the same Radio Data System network.

"ON" (Default), "OFF"

[TA]

Switches to the traffic information automatically when the traffic bulletin starts. (**TI** indicator lights up.)

"ON", "OFF" (Default)

[RDS Clock Sync]

Synchronizing the Radio Data System station time data and this unit's clock.

"ON" (Default), "OFF"

[PTY]

Select a program type.

[PTY Seek]

Searches for a program by program type.

*1 FM only

3 Touch [↶].

Preparation

■ Connecting a USB device

- 1 Remove the cap of the USB terminal.
- 2 Connect the USB device with the USB cable.

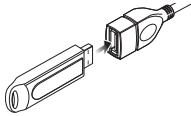

The unit reads the device and playback starts.

■ To disconnect the USB device:

- 1 Press the <↑> button.
- 2 Touch a source other than [USB].
- 3 Detach the USB device.

■ Usable USB device

This unit can play MPEG1/ MPEG2/ MPEG4/ H.264/ MKV/ MP3/WMA/ AAC/ WAV/ FLAC/ OGG files stored in a USB mass storage class device. **(P.28)**

- File system: FAT16/ FAT32/ NTFS
- This unit can recognize a total of 9 999 files and 320 folders (a maximum of 9 999 files per folder).
- The maximum number of characters:
 - Folder names : 70 characters
 - File names : 70 characters
 - Tag : 70 characters

📎 NOTE

- When the USB device is connected to this unit, it can be charged through the USB cable.
- Install the USB device in the place where it will not affect safe driving.
- You cannot connect a USB device via a USB hub and Multi Card Reader.
- Take backups of the audio files used with this unit. The files may be erased depending on the operating conditions of the USB device.
We shall have no compensation for any damage arising from any erased data.
- No USB device comes with this unit. You need to purchase a commercially available USB device.
- Cap the USB terminal whenever not using.

Playback operations

■ Control the music you are listening to on the source control screen.

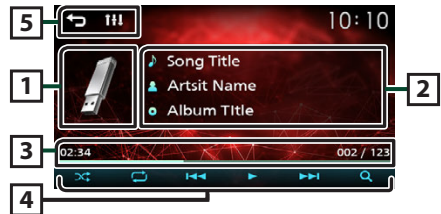

- 1 The jacket of the currently playing file is displayed.
- 2 Displays the information of the current file.
- 3 Playing time/File number
Play time bar : For confirmation of current playing position.
- 4 [⏮] : Selects Random playback mode.
 - ⏮ : Randomly plays all files in the current folder.
 - ⏮ (Default): Normal playback.[🔄] : Selects Repeat playback mode.
 - 🔄 (Default): Repeats all files in the USB device.
 - 🔄 : Repeats the current file.
 - 🔄 : Repeats all files in the current folder.[▶], [⏸] : Plays or pauses.
[⏪], [⏩] : Searches the previous/next content.
Touch and hold to fast forward or fast backward.
[🔍] : Searches file. **(P.11)**
- 5 [⏪] : Returns to previous screen.
[🔍] : Displays the Audio screen. **(P.20)**

For Video playback

1 When the operation buttons are not displayed on the screen, touch the display.

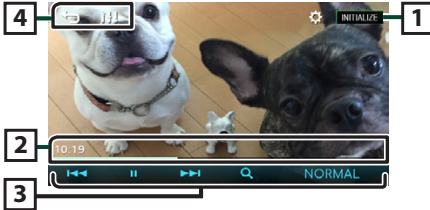

1 **[INITIALIZE]**: You can adjust image quality in video screen.

[Brightness]: Adjusts the brightness. (00 to 10)

[Contrast]: Adjusts the contrast. (00 to 10)

[Color]: Adjusts the color. (00 to 10)

[Tint]: Adjusts the tint. (00 to 10)

[INITIALIZE]: To clear the adjustment.

2 Playing time

Play time bar: For confirmation of current playing position.

3 **[▶], [⏸]**: Plays or pauses.

[⏮], [⏭]: Searches the previous/next content.

Touch and hold to fast forward or fast backward.

[Q]: Searches file. **(P.11)**

[NORMAL]/[16:9]/[4:3]: Select a screen mode.

4 **[⏪]**: Returns to previous screen.

[🔊]: Displays the Audio screen. **(P.20)**

Selecting a track in a list (Searches file)

1 Touch [Q].

2 Select whether you search by audio files [🎵], video files [🎬].

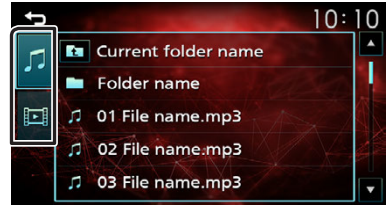

3 Touch [⏪] to moves to the upper hierarchy.

4 Touch the desired folder.

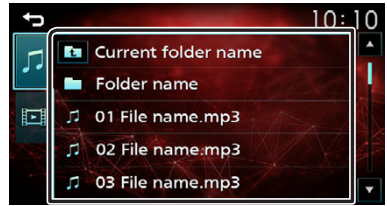

When you touch a folder its contents are displayed.

- Touch [⏪] to moves to the upper hierarchy.

5 Touch desired item from the content list.

Playback starts.

NOTE

- The source control screen appears when you touch [⏪] at the top hierarchy.

iPod/iPhone

Preparation

■ Connecting iPod/iPhone

- For Lightning connector models: Use USB Audio cable for iPod/iPhone—KS-U62 (optional accessory).
- For details about connecting iPod/iPhone, see page 27.

1 Remove the cap of the USB terminal.

2 Connect the iPod/iPhone.

The unit reads the device and playback starts.

■ To disconnect the iPod/iPhone

1 Press the button.

2 Touch a source other than [iPod].

3 Detach the iPod/iPhone.

■ Connectable iPod/iPhone

The following models can be connected to this unit.

Made for

- iPhone 12 Pro Max
- iPhone 12 Pro
- iPhone 12
- iPhone 12 mini
- iPhone SE (2nd generation)
- iPhone 11 Pro Max
- iPhone 11 Pro
- iPhone 11
- iPhone XS Max
- iPhone XS
- iPhone XR
- iPhone X
- iPhone 8 Plus
- iPhone 8
- iPhone 7 Plus
- iPhone 7
- iPhone SE
- iPhone 6s Plus
- iPhone 6s
- iPhone 6 Plus

NOTE

- If you start playback after connecting the iPod, the music that has been played by the iPod is played first.
- Cap the USB terminal whenever not using.

Playback operations

■ Control the music you are listening to on the source control screen.

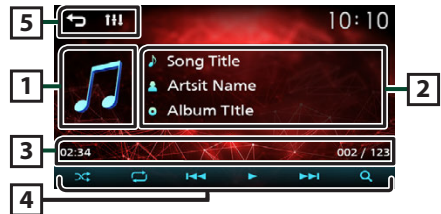

1 Artwork (Shown if the track contains artwork)

2 Displays the information of the current file.

3 Playing time/File number

Play time bar : For confirmation of current playing position.

4  : Selects Random playback mode.

 : Functions the same as Shuffle Songs.

 : Random off



 : Selects Repeat playback mode.

 : Functions the same as Repeat All.

 : Functions the same as Repeat One.

 : Repeat off

,  : Plays or pauses.

,  : Searches the previous/next content.

Touch and hold to fast forward or fast backward.

 : Searches content. **(P.13)**

5  : Returns to previous screen.

 : Displays the Audio screen. **(P.20)**

iPod/iPhone

■ Selecting a content in a list

1 Touch [Q].

2 Touch desired item.



When you touch a category its contents are displayed.

3 Touch desired item from the content list.

Playback starts.

- Touch [↶] to moves to the upper hierarchy.

📎 NOTE

- The source control screen appears when you touch [↶] at the top hierarchy.

Mirroring

Preparation

You can display and control the App on the unit while your smartphone is connected to the USB terminal.

NOTE

- Pair your smartphone with the unit via Bluetooth. See **Register your smartphone to the unit (P.17)** and Connect the Bluetooth device.

Compatible Android smartphone

- Android version 7.0 or later
- Bluetooth support

NOTE

- This unit may not work for some Android smartphone's.

Connecting Android smartphone

1 Download Mirroring App from Google Play.

Install the latest version of the Mirroring application "Mirroring OB for JVC" on your Android.

2 Remove the cap of the USB terminal.

3 Connect the Android smartphone. (P.27)

4 Launch Mirroring App on your Android Smartphone.

- 1) Touch to check mark.

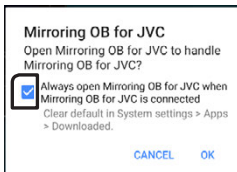

- 2) Touch "OK" to start Mirroring App.
- 3) Touch to check mark.

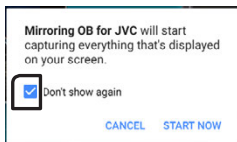

- 4) Touch "START NOW" to start capturing your Android screen.

5 Start to enjoy Mirroring.

To disconnect the Android smartphone

1 Press the button.

2 Touch a source other than [Mirroring].

3 Detach the Android smartphone.

Mirroring operations

Mirroring Operation

1 Touch [Mirroring].



- You can display the same screen of the Android device on the monitor of the unit.

To turn off the Mirroring

1 Press the button.



- HOME screen appears.

External Components

Using external audio/video players

Starting playback

- 1 Connect an external component to the AV-IN input terminal. (P.26)
- 2 Press the button.
- 3 Touch [AV-IN].
- 4 Turn on the connected component and start playing the source.

For Video playback

- 1 When the operation buttons are not displayed on the screen, touch the display.

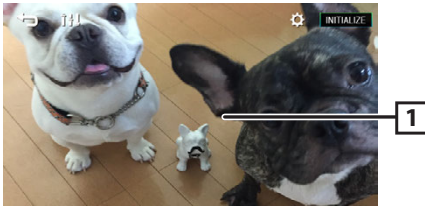

NOTE

- When the picture from the rear view camera is displayed on the AV-IN screen, the picture output from the Visual Output terminal disappears.

Rear view camera

To use a rear view camera, the REVERSE lead connection is required. For connecting a rear view camera. (P.26)

Displaying the picture from the rear view camera

The rear view screen is displayed when you shift the gear to the reverse (R) position.



- To erase the caution message, touch the screen.

External Components

To adjust the parking guidelines

NOTE

- Install the rear view camera in the appropriate position according to the instruction manual supplied with the rear view camera.
- When adjusting the parking guidelines, make sure to apply the parking brake to prevent the car from moving.

1 Press the button.

2 Touch [].

3 Touch [System].

4 Touch [◀] or [▶] of [Parking Guidelines] and set to [ON].

5 Touch [Guidelines SETUP].

6 Adjust the parking guidelines by selecting the [] mark.

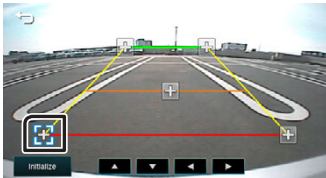

7 Adjusting the position of the selected mark.

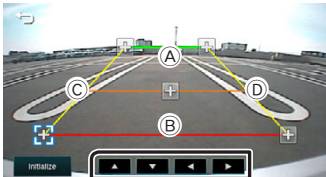

Make sure that lines A and B are horizontally parallel, and that lines C and D are of the same length.

NOTE

- Touch [Initialize] and then touch [Yes] to set all the marks to their initial default position.

Bluetooth

About the Bluetooth smartphone and Bluetooth audio player

This unit conforms to the following Bluetooth specifications:

Version

Bluetooth Ver.5.0

Profile

Smartphone/ Cell-phone:

HFP (V1.7) (Hands Free Profile)

PBAP (Phonebook Access Profile)

Audio player:

A2DP (Advanced Audio Distribution Profile)

AVRCP (V1.5) (Audio/Video Remote Control Profile)

Sound codec

SBC

About mobile phones compatible with Phone book Access Profile (PBAP)

If your mobile phone supports PBAP, you can display the following items on the touch panel screen when the mobile phone is connected.

- Phone book (up to 1000 entries)
- Dialed calls, received calls, and missed calls (up to 50 entries in total)

Register your smartphone to the unit

You can use your Bluetooth smartphone when paired to this unit.

You can register up to 8 Bluetooth devices.

- You can pair the device and the unit using SSP (Secure Simple Pairing) which only requires confirmation.
- One device can be connected at a time.
- When you register a new Bluetooth device, disconnect the Bluetooth device currently connected and then register the new device.
- A new device cannot be registered if there are 8 registered Bluetooth units. Delete unnecessary registration. **(P.17)**

1 Turn on the Bluetooth function on your smartphone/cell-phone.

2 Search the unit ("KW-M27DBT") from your smartphone/cell-phone.

If a PIN code is required, enter the PIN code ("0000").

-  appears when the Bluetooth smartphone is connected.

Disconnecting the device

- Turn off the Bluetooth function from your smartphone/cell-phone.
- Turn off the ignition switch.

Bluetooth Setup

1 Press the < > button.

2 Touch [].

3 Touch [Bluetooth].

4 Touch the corresponding key and set the value.

[Select Device]

Connect the Bluetooth device.

[Phone Auto Answer]

Set the automatic response time to pick-up an incoming call.

"OFF" (Default) / "ON"

[Device Name]

The Bluetooth device name of this unit is displayed.

[Pin Code]

Displays the PIN code.

[Device address]

Displays the device address.

Connect the Bluetooth device

1 Touch [Select Device] on the Bluetooth Setup screen.

2 Touch [] of the device you want to connect.



To delete the registered Bluetooth device

1 Touch [] on the Select Device screen.

Bluetooth

Receive a phone call

1 Touch [Phone].

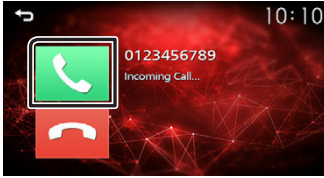

- [Phone]: Reject an incoming call.

Operations during a call

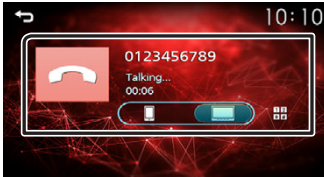

[Phone] Ending a call

[1 2] [x #] You can send tones by touching desired keys on the screen.

- Touch [Back] to close the window.

[Smartphone/Cellphone] [Speaker] Switches the speaking voice output between smartphone/cell-phone and speaker.

- **Adjust the receiver volume**
Press the < + > or < - > button.

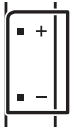

Make a phone call

1 Press the < Home > button.

2 Touch [Phone].

3 See the table below for each operation method.



Call by entering a phone number

1) Enter a phone number with number keys.

2) Touch [Phone].

Make a call

- Touch [X] to delete the last entry.

Call using call records

1) Touch [Phone].

2) Touch [Incoming Calls], [Outgoing Calls], [Missed Calls].

3) Select the phone number from the list.



Make a call

Call using the phonebook

1) Touch [Phone].

2) Select the name from the list.



Make a call

- [Phone]: Updates the phonebook. Touch this button after you have made a change to the phonebook of your smartphone/cell-phone.

Bluetooth

Call by voice

You can make a voice call using the voice recognition function of the Bluetooth smartphone.

- 1) Touch [🗨️].
- 2) Say the name registered in the Bluetooth smartphone.



- Touch [Cancel] to cancel voice dialing.

Playing Bluetooth Audio Device

- 1 Press the <🏠> button.
- 2 Touch [BT Audio].

Source control screen

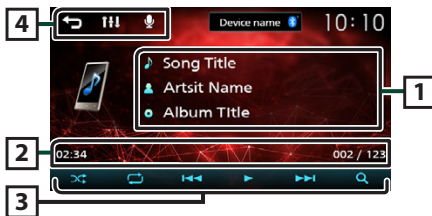

- 1 Displays the information of the current file.
- 2 Playing time/File number
Play time bar : For confirmation of current playing position.
- 3 [🔀] : Selects Random playback mode.
 [🔀]: Randomly plays all files.
 [🔀]: Random off
 [🔁] : Selects Repeat playback mode.
 [🔁]: Repeats all files.
 [🔁]: Repeats the current file.
 [🔁]: Repeat off
 [▶], [⏸] : Plays or pauses.
 [⏮], [⏭] : Searches the previous/next content.
 Touch and hold to fast forward or fast backward.
 [🔍] : Searches file. **(P.19)**
- 4 [🏠] : Returns to previous screen.
 [📶] : Displays the Audio screen. **(P.20)**
 [🗨️] : Displays the Voice Recognition screen.*

NOTE

- Operations and display indications may differ according to their availability on the connected device.
- * You can access the voice recognition function of the Bluetooth smartphone connected to this unit. (The functionality depends on the Bluetooth smartphone.)

Selecting a content in a list

- 1 Touch [Q].
- 2 Touch desired item.



When you touch a category its contents are displayed.

3 Touch desired item from the content list.

- Playback starts.
- Touch [↶] to moves to the upper hierarchy.

NOTE

- The source control screen appears when you touch [↶] at the top hierarchy.

Controlling Audio

You can adjust various settings such as audio balance or subwoofer level.

- 1 Press the <EQ> button.
- 2 See the below for each operation method.



Controlling General Audio

- 1 Press the <EQ> button.
- 2 Touch [Fader / Balance].
- 3 Set each item as follows.

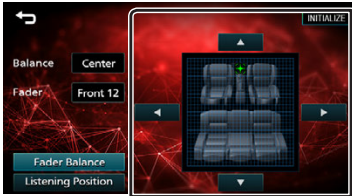

[Fader Balance]

Balance Adjust the left and right volume balance.
 [▶][◀]
 15 (right) to 15 (left)

Fader Adjust the front and rear volume balance.
 [▲][▼]
 15 (front) to 15 (rear)

[INITIALIZE] To clear the adjustment.

[Listening Position]

[●] Select a listening position from "Front Left", "Front All", "Front Right", and "Middle".

[INITIALIZE] To clear the adjustment.

Equalizer Control

- 1 Press the <EQ> button.
- 2 Touch [Equalizer].
- 3 Set each item as follows.



- 1 You can select frequency bar and adjust its level. (-9 to +9)
 • The adjustments are stored.
- 2 To recall the preset equalizer curve.
- 3 Recalls the memorized EQ curve.
- 4 Initialize the current EQ curve.

Controlling Audio

Speaker / X'Over setup

- 1 Press the <EQ> button.
- 2 Touch [Speaker / X'Over].
- 3 Touch the speaker to set up.

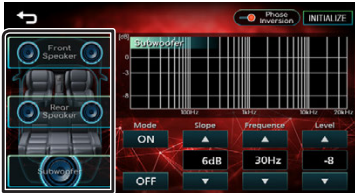

4 Set each item as follows.

Mode [OFF], [ON]	[ON] : Filter adjustment. [OFF] : Turns off the filter.
Slope [▲] [▼]	Set a crossover slope.
Frequency [▲] [▼]	<ul style="list-style-type: none"> • High Pass Filter adjustment. (When Front or Rear is selected) • Low Pass Filter adjustment. (When Subwoofer is selected)
Level [▲] [▼]	Adjust the gain of the front speaker, rear speaker, or subwoofer.
Phase Inversion	Set the phase of subwoofer output. [] to shift the phase 180 degrees. (When Subwoofer is selected)
[INITIALIZE]	To clear the adjustment.

Listening Position / DTA

- 1 Press the <EQ> button.
- 2 Touch [Position / DTA].
- 3 Touch [Delay].
- 4 Touch [◀] or [▶] to adjust the delay time of the selected speaker.



- 5 Touch [Level].
- 6 Touch [◀] or [▶] to adjust the sound level of the selected speaker.

Sound Effect

- 1 Press the <EQ> button.
- 2 Touch [Sound Effect].
- 3 Set each item as follows.

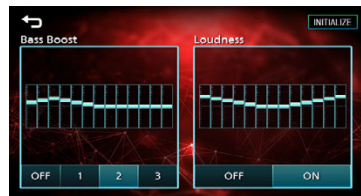

Bass Boost [OFF], [1], [2], [3]	Set the amount of bass boost
Loudness [OFF], [ON]	Set the amount of boost of low and high tones.
[INITIALIZE]	To clear the adjustment.

Remote control

This unit can be operated using the remote control. The remote control RM-RK258 (optional accessory) can be used.

▲WARNING

- Do not ingest the battery, Chemical Burn Hazard
The remote control supplied with this product contains a coin/button cell battery. If the coin/button cell battery is swallowed, it can cause severe internal burns in just 2 hours and can lead to death. Keep new and used batteries away from children. If the battery compartment does not close securely, stop using the product and keep it away from children.
- If you think batteries might have been swallowed or placed inside any part of the body, seek immediate medical attention.

▲CAUTION

- Put the remote control in a place where it will not move during braking or other operations. A dangerous situation could result, if the remote control falls down and gets wedged under the pedals while driving.
- Risk of fire or explosion if the battery is replaced by an incorrect type. Ensure to replace only with the same type.
- Risk of fire, explosion or the leakage of flammable liquid or gas if the battery is left in an extremely high temperature surrounding environment and/or subjected extremely low air pressure. The battery pack or batteries shall not be exposed to excessive heat such as sunshine, fire or the like.
- Risk of fire, explosion or the leakage of flammable liquid or gas if the battery is disposed into fire or a hot oven, recharged, shorted, mechanically crushed or cut of the battery.
- If spilled fluid comes in contact with your eyes or on clothing, immediately rinse with water and consult a physician.

Functions of the Remote control Buttons

- Aim the remote control directly at the remote sensor on the faceplate.
- DO NOT expose the remote sensor to bright light (direct sunlight or artificial lighting).

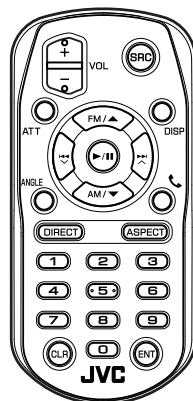

SRC	Switches to the source to be played.
VOL + -	Adjusts the volume.
ATT	Mutes/restores the sound
DISP	Not used.
FM/▲ AM/▼	Selects the folder to be played. During tuner source, select FM/ AM band to be received.
◀◀ ◻ ▶▶ ▲	During tuner source, switches to broadcast stations received by the unit.
▶/	For the USB, BT audio, Plays or pauses.
ANGLE	Not used.
☎	When a call comes in, answers the call.
DIRECT	Not used.
ASPECT	Not used.
Numeric Keypad	Not used.
CLR	Clears the telephone number input on the Phone screen.
ENT	Not used.

Installation

Before Installation

Before installation of this unit, please note the following precautions.

▲WARNINGS

- If you connect the ignition wire (red) and the battery wire (yellow) to the car chassis (ground), you may cause a short circuit, that in turn may start a fire. Always connect those wires to the power source running through the fuse box.
- Do not cut out the fuse from the ignition wire (red) and the battery wire (yellow). The power supply must be connected to the wires via the fuse.

▲CAUTION

- Install this unit in the console of your vehicle. Do not touch the metal part of this unit during and shortly after the use of the unit. Metal part such as the heat sink and enclosure become hot.

🔧 NOTE

- Mounting and wiring this product requires skills and experience. For best safety, leave the mounting and wiring work to professionals.
- Make sure to ground the unit to a negative 12V DC power supply.
- Do not install the unit in a spot exposed to direct sunlight or excessive heat or humidity. Also avoid places with too much dust or the possibility of water splashing.
- Do not use your own screws. Use only the screws provided. If you use the wrong screws, you could damage the unit.
- If your car's ignition does not have an ACC position, connect the ignition wires to a power source that can be turned on and off with the ignition key. If you connect the ignition wire to a power source with a constant voltage supply, such as with battery wires, the battery may be drained.
- If the console has a lid, make sure to install the unit so that the front panel will not hit the lid when closing and opening.
- If the fuse blows, first make sure the wires aren't touching to cause a short circuit, then replace the old fuse with one with the same rating.
- Insulate unconnected wires with vinyl tape or other similar material. To prevent a short circuit, do not remove the caps on the ends of the unconnected wires or the terminals.
- Secure the wires with cable clamps and wrap vinyl tape around the wires that comes into contact with metal parts to protect the wires and to prevent short circuit.

- Connect the speaker wires correctly to the terminals to which they correspond. The unit may be damaged or fail to work if you share the ⊖ wires or ground them to any metal part in the car.
- When only two speakers are being connected to the system, connect the connectors either to both the front output terminals or to both the rear output terminals (do not mix front and rear). For example, if you connect the ⊕ connector of the left speaker to a front output terminal, do not connect the ⊖ connector to a rear output terminal.
- After the unit is installed, check whether the brake lamps, blinkers, wipers, etc. on the car are working properly.
- Mount the unit so that the mounting angle is 30° or less.
- Do not press hard on the panel surface when installing the unit to the vehicle. Otherwise scars, damage, or failure may result.
- Reception may drop if there are metal objects near the Bluetooth antenna.



Installation

Supplied accessories for installation

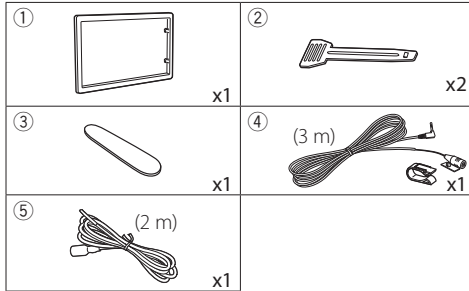

Installation procedure

- 1) To prevent a short circuit, remove the key from the ignition and disconnect the \ominus terminal of the battery.
- 2) Make the proper input and output wire connections for each unit.
- 3) Connect the ISO connector to the unit.
- 4) Install the unit in your car.
- 5) Reconnect the \ominus terminal of the battery.
- 6) Press the reset button.

Installing the unit

Non-Japanese cars

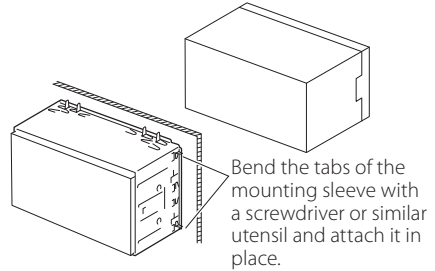

NOTE

- Make sure that the unit is installed securely in place. If the unit is unstable, it may malfunction (eg, the sound may skip).

Trim plate

- 1) Attach accessory ① to the unit.

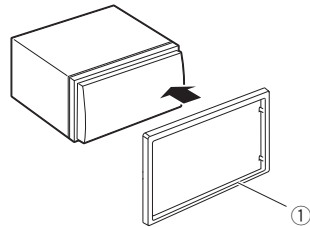

Installation

Microphone unit

- 1) Check the installation position of the microphone (accessory ④).
- 2) Clean the installation surface.
- 3) Remove the separator of the microphone (accessory ④), and stick the microphone to the place shown below.
- 4) Wire the microphone cable up to the unit with it secured at several positions using tape or other desired method.
- 5) Adjust the direction of the microphone (accessory ④) to the driver.

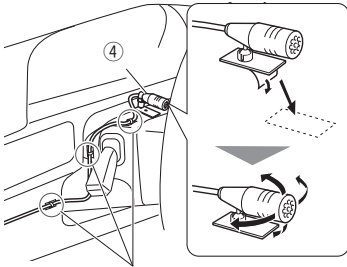

Fix a cable with a commercial item of tape.

NOTE

- Swap the clips if necessary.

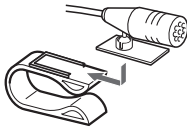

Removing the trim plate

- 1) Use the extraction key (accessory ③) to lever out the four tabs (two on the left part, two on the right part).

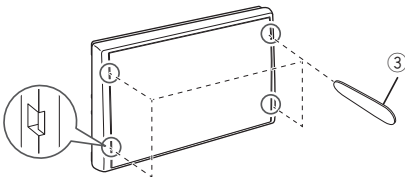

- 2) Pull the trim plate forward.

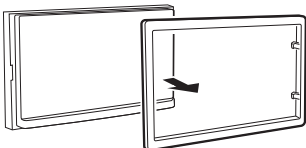

Removing the unit

- 1) Remove the trim plate by referring to step 1 in "Removing the trim plate".
- 2) Insert the extraction key (accessory ②) deeply into the slot as shown. (The protrusion at the tip of the extraction key must face toward the unit.)

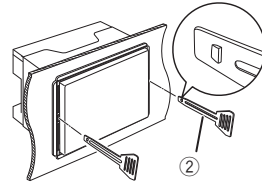

- 3) With the inserted extraction key secured, insert the other extraction key into the slot.

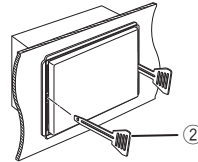

- 4) Pull out the unit halfway.

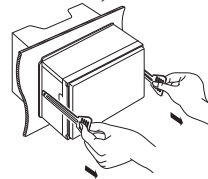

NOTE

- Be careful to avoid injury from the catch pins on the extraction key.
- 5) Pull the unit all the way out with your hands, being careful not to drop it.

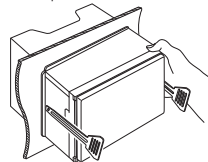

Installation

Connecting wires to terminals

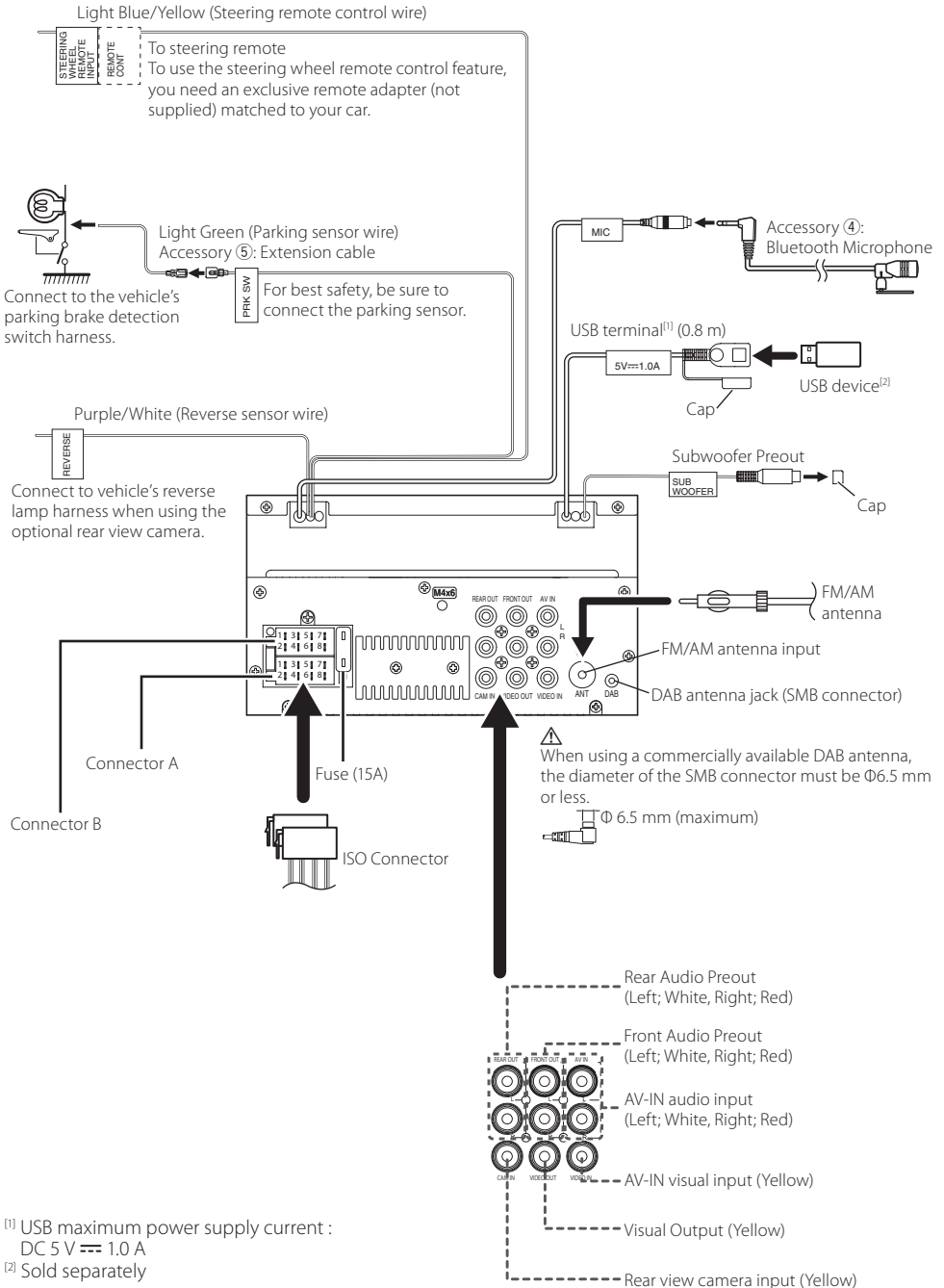

^[1] USB maximum power supply current : DC 5 V = 1.0 A

^[2] Sold separately

Installation

Wiring harness connector function guide

Pin	Color and function	
A-4	Yellow	Battery
A-5	Blue/White ^[1]	Power Control
A-7	Red	Ignition (ACC)
A-8	Black	Earth (Ground) Connection
B-1/ B-2	Purple (+) / Purple/Black (-)	Rear Right
B-3/ B-4	Gray (+) / Gray/Black (-)	Front Right
B-5/ B-6	White (+) / White/Black (-)	Front Left
B-7/ B-8	Green (+) / Green/Black (-)	Rear Left

^[1] Max. 150mA, 12V

- Speaker Impedance: 4-8 Ω

CAUTION

Before you connect the commercially available ISO connectors to the unit, check the following condition:

- Make sure that the pin assignment of the connector matches with the JVC unit.
- Take extra notice of the power wire.
- In case battery wire and ignition wire are not corresponding then change them accordingly.
- In case the car does not have an ignition wire, use a commercially available interface.

Connecting an iPod/iPhone/Android

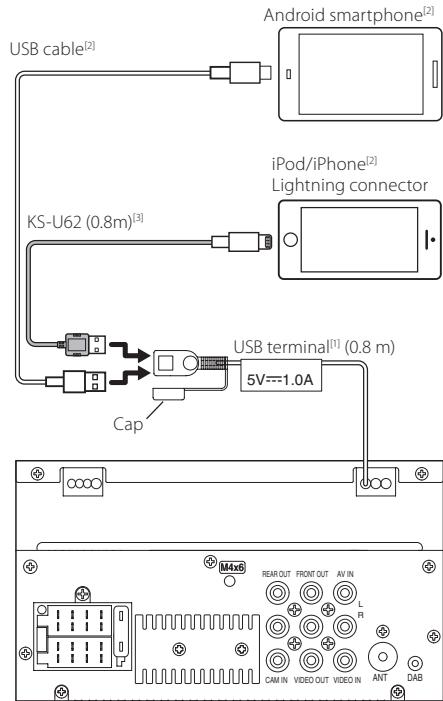

^[1] USB maximum power supply current :

DC 5 V \pm 1.0 A

^[2] Sold separately

^[3] Optional accessory

About this Unit

More information

▶ Playable Audio files

Audio format	Bit rate/ (Bit count)	Sampling frequency
MP3 (.mp3)	16 – 320kbps, VBR	16 – 48 kHz
WMA (.wma)	16 – 320kbps	16 – 48 kHz
AAC-LC (.m4a, .aac)	16 – 320kbps	16 – 48 kHz
Linear PCM (WAVE) (.wav)	(16/24 bit)	8 – 192 kHz
FLAC (.flac)	(16/24 bit)	8 – 192 kHz
Vorbis (.ogg)	(16 bit)	8 – 192 kHz

- This unit can show ID3 Tag Version 1.0/1.1/2.2/2.3/2.4 (for MP3).
- The maximum number of characters:
 - Tag : 70 characters

🔧 NOTE

- WMA and AAC of which is covered with DRM cannot be played.
- Although the audio files are complied with the standards listed above, the play may be impossible depending on the types or conditions of media or device.

▶ Acceptable Video files

Video format	Video codec	Audio codec
MPEG-1 (.mpg, .mpeg)	MPEG-1	MPEG Audio Layer 2
MPEG-2 (.mpg, .mpeg)	MPEG-2	MPEG Audio Layer 2
MPEG-4 (.mp4, .avi)	MPEG-4 (SP,ASP)	MP3, AAC-LC (2ch)
H.264/MPEG-4 AVC (.mp4, .mkv, .avi, .flv, .f4v, .ts)	H.264/MPG-4 AVC (BP/MP/HP)	MP3, AAC (2ch)
MKV (.mkv)	Video Format follows H.264/ MPEG-4 AVC, MPEG4, XVID	MP3, AAC, Vorbis, FLAC

Troubleshooting

What appears to be trouble is not always serious. Check the following points before calling a service center.

- For operations with the external components, refer also to the instructions supplied with the adapters used for the connections (as well as the instructions supplied with the external components).

▶ General

No sound comes out of the speakers.

- Adjust the volume to the optimum level.
- Check the cords and connections.

The unit does not work at all.

- Reset the unit. (P.2)

The remote controller does not work.

- Replace the battery.

▶ USB

While playing a track, sound is sometimes interrupted.

- The tracks are not properly copied into the USB device. Copy the tracks again, and try again.

▶ iPod/iPhone

No sound comes out of the speakers.

- Disconnect the iPod/iPhone, then connect it again.
- Select another source, then reselect "iPod".

The iPod/iPhone does not turn on or does not work.

- Check the connecting cable and its connection.
- Update the firmware version of iPod/iPhone.
- Charge the battery of iPod/iPhone.
- Reset the iPod/iPhone.

Sound is distorted.

- Deactivate the equalizer either on this unit or the iPod/iPhone.

A lot of noise is generated.

- Turn off (uncheck) "VoiceOver" on the iPod/iPhone. For details, visit <<http://www.apple.com>>.

About this Unit

Tuner

Automatic presetting does not work.

- Store stations manually. **(P.8)**

Static noise while listening to the radio.

- Connect the antenna firmly.

AV-IN

No picture appears on the screen.

- Turn on the video component if it is not on.
- Connect the video component correctly.

Bluetooth

Phone sound quality is poor.

- Reduce the distance between the unit and the Bluetooth mobile phone.
- Move the car to a place where you can get a better signal reception.

The sound is interrupted or skipped while using a Bluetooth audio player.

- Reduce the distance between the unit and the Bluetooth audio player.
- Turn off, then turn on the unit. (When the sound is not yet restored) connect the player again.

The connected audio player cannot be controlled.

- Check whether the connected audio player supports AVRC (Audio/Video Remote Control Profile).

The Bluetooth device does not detect the unit.

- Search from the Bluetooth device again.

The unit does not pair with the Bluetooth device.

- Turn off, then turn on the Bluetooth device.
- Disconnect the Bluetooth device currently connected and then register the new device. **(P.17)**

About this Unit

Specifications

Monitor section

Picture Size

- : 6.75 inches (diagonal) wide
- : 151.8 mm (W) × 79.7 mm (H)

Display System

- : Transparent TN LCD panel

Drive System

- : TFT active matrix system

Number of Pixels

- : 1,152,000 (800H x 480V x RGB)

Effective Pixels

- : 99.99 %

Pixel Arrangement

- : RGB striped arrangement

Back Lighting

- : LED

USB interface section

USB Standard

- : USB 2.0 High Speed

File System

- : FAT 16/ FAT 32 / NTFS

Maximum Power Supply Current

- : DC 5 V  1.0 A

D/A Converter

- : 24 Bit

Audio Decoder

- : MP3/ WMA/ WAV/ AAC/ FLAC

Video Decoder

- : MPEG1/ MPEG2/ MPEG4/ H.264/ MKV

Frequency Response

- 96 kHz : 20 – 20,000 Hz
- 48 kHz : 20 – 20,000 Hz
- 44.1 kHz : 20 – 20,000 Hz

Bluetooth section

Technology

- : Bluetooth Ver.5.0

Frequency

- : 2.402 – 2.480 GHz

Output Power

- : +8 dBm (AVE), Power Class1

Maximum Communication range

- : Line of sight approx. 10m (32.8 ft)

Audio Codec

- : SBC

Profile (Multi Profile support)

- HFP (V1.7) (Hands Free Profile)
- A2DP (Advanced Audio Distribution Profile)
- AVRCP (V1.5) (Audio/Video Remote Control Profile)
- PBAP (Phonebook Access Profile)

DSP section

Graphics equalizer

- Band : 13 Band

- Frequency: 62.5/100/160/250/400/630/1k/1.6k/2.5k/
4k/6.3k/10k/16k Hz

- Level: -9 – +9

X'Over

High pass filter

- Frequency: Through / 30/40/50/60/70/80/90/100/
120/150/180/220/250 Hz

- Slope: -6/-12/-18/-24 dB/Oct.

- Gain: -8/-7/-6/-5/-4/-3/-2/-1/0 dB

Low pass filter

- Frequency: 30/40/50/60/70/80/90/100/120/150/180/
220/250 Hz / through

- Slope: -6/-12/-18/-24 dB/Oct.

- Gain: -8/-7/-6/-5/-4/-3/-2/-1/0 dB

Position

- Front / Rear / Subwoofer Delay

- : 0 to 6.1m (0.01m Step)

- Gain: -8 – 0 dB

FM tuner section

Frequency Range (step)

- : 87.5 MHz – 108.0 MHz (50 kHz)

Usable Sensitivity

- : 16.2 dBf

- : 1.8 μ V/75 Ω (S/N : 30 dB)

Frequency Response

- : 30 Hz – 14 kHz

S/N Ratio (dB)

- : 50 dB (MONO)

Stereo Separation

- : 35 dB (1 kHz)

About this Unit

AM tuner section

Frequency Range (step)
: 531 – 1611 kHz (9 kHz)

Usable Sensitivity
: 99 μ V (40 dB μ)

DAB section

Frequency Range
BAND III: 174.928 – 239.200 (MHz)

Sensitivity
: -98 dBm

S/N Ratio (dB)
: 82 dB

Digital Antenna Connector section

Connector type
: SMB

Output Voltage (11 – 16V)
: 12V DC car battery

Maximum Current
: < 100 mA

Video section

Color System of External Video Input
: NTSC/PAL

External Video Input Level (RCA jacks)
: 1 Vp-p/ 75 Ω

External Audio Max Input Level (RCA jacks)
: 1.5 V/ 25 k Ω

Video Output Level (RCA jacks)
: 1 Vp-p/ 75 Ω

Audio section

Maximum Power (Front & Rear)
: 45 W \times 4

Full Bandwidth Power (Front & Rear)
(at less than 1% THD)
: 16 W \times 4

Output frequency band
: 20 – 20,000 Hz

Preout Level (V)
: 2 V/ 10 k Ω

Preout Impedance
: 1.4 k Ω

Speaker Impedance
: 4 – 8 Ω

General

Operating Voltage
: 12V DC car battery

Installation Dimensions (W \times H \times D)
: 182 \times 112 \times 75 mm

Main Unit Installation size (W \times H \times D)
: 178 \times 100 \times 75 mm (w/o sleeve)

Weight
: 1.3 kg
(Including Sleeve and Trim plate)

NOTE

- Although the effective pixels for the liquid crystal panel is given as 99.99% or more, 0.01% of pixels may not light or may light incorrectly.
- Specifications subject to change without notice.

About this Unit

Copyrights

- The Bluetooth word mark and logos are registered trademarks owned by the Bluetooth SIG, Inc. and any use of such marks by JVCKENWOOD Corporation is under license. Other trademarks and trade names are those of their respective owners.
- Use of the Made for Apple badge means that an accessory has been designed to connect specifically to the Apple product(s) identified in the badge and has been certified by the developer to meet Apple performance standards. Apple is not responsible for the operation of this device or its compliance with safety and regulatory standards. Please note that the use of this accessory with an Apple product may affect wireless performance.
- Apple, iPhone, iPod, iPod touch, and Lightning are trademarks of Apple Inc., registered in the U.S. and other countries.
- Microsoft and Windows Media are either registered trademarks or trademarks of Microsoft Corporation in the United States and/or other countries.
- THIS PRODUCT IS LICENSED UNDER THE MPEG-4 VISUAL PATENT PORTFOLIO LICENSE FOR THE PERSONAL AND NON-COMMERCIAL USE OF A CONSUMER FOR (i) ENCODING VIDEO IN COMPLIANCE WITH THE MPEG-4 VISUAL STANDARD ("MPEG-4 VIDEO") AND/OR (ii) DECODING MPEG-4 VIDEO THAT WAS ENCODED BY A CONSUMER ENGAGED IN A PERSONAL AND NON-COMMERCIAL ACTIVITY AND/OR WAS OBTAINED FROM A VIDEO PROVIDER LICENSED BY MPEG LA TO PROVIDE MPEG-4 VIDEO. NO LICENSE IS GRANTED OR SHALL BE IMPLIED FOR ANY OTHER USE. ADDITIONAL INFORMATION INCLUDING THAT RELATING TO PROMOTIONAL, INTERNAL AND COMMERCIAL USES AND LICENSING MAY BE OBTAINED FROM MPEG LA, LLC. SEE [HTTP://WWW.MPEGLA.COM](http://www.mpegla.com).
- THIS PRODUCT IS LICENSED UNDER THE AVC PATENT PORTFOLIO LICENSE FOR THE PERSONAL USE OF A CONSUMER OR OTHER USES IN WHICH IT DOES NOT RECEIVE REMUNERATION TO (i) ENCODE VIDEO IN COMPLIANCE WITH THE AVC STANDARD ("AVC VIDEO") AND/OR (ii) DECODE AVC VIDEO THAT WAS ENCODED BY A CONSUMER ENGAGED IN A PERSONAL ACTIVITY AND/OR WAS OBTAINED FROM A VIDEO PROVIDER LICENSED TO PROVIDE AVC VIDEO. NO LICENSE IS GRANTED OR SHALL BE IMPLIED FOR ANY OTHER USE. ADDITIONAL INFORMATION MAY BE OBTAINED FROM MPEG LA, L.L.C. SEE [HTTP://WWW.MPEGLA.COM](http://www.mpegla.com)
- libFLAC
Copyright (C) 2000-2009 Josh Coalson
Copyright (C) 2011-2013 Xiph.Org Foundation
 - Redistribution and use in source and binary forms, with or without modification, are permitted provided that the following conditions are met:
 - Redistributions of source code must retain the above copyright notice, this list of conditions and the following disclaimer.
- Redistributions in binary form must reproduce the above copyright notice, this list of conditions and the following disclaimer in the documentation and/or other materials provided with the distribution.
Neither the name of the Xiph.org Foundation nor the names of its contributors may be used to endorse or promote products derived from this software without specific prior written permission.
THIS SOFTWARE IS PROVIDED BY THE COPYRIGHT HOLDERS AND CONTRIBUTORS "AS IS" AND ANY EXPRESS OR IMPLIED WARRANTIES, INCLUDING, BUT NOT LIMITED TO, THE IMPLIED WARRANTIES OF MERCHANTABILITY AND FITNESS FOR A PARTICULAR PURPOSE ARE DISCLAIMED. IN NO EVENT SHALL THE FOUNDATION OR CONTRIBUTORS BE LIABLE FOR ANY DIRECT, INDIRECT, INCIDENTAL, SPECIAL, EXEMPLARY, OR CONSEQUENTIAL DAMAGES (INCLUDING, BUT NOT LIMITED TO, PROCUREMENT OF SUBSTITUTE GOODS OR SERVICES; LOSS OF USE, DATA, OR PROFITS; OR BUSINESS INTERRUPTION) HOWEVER CAUSED AND ON ANY THEORY OF LIABILITY, WHETHER IN CONTRACT, STRICT LIABILITY, OR TORT (INCLUDING NEGLIGENCE OR OTHERWISE) ARISING IN ANY WAY OUT OF THE USE OF THIS SOFTWARE, EVEN IF ADVISED OF THE POSSIBILITY OF SUCH DAMAGE.
- libogg
Copyright (c) 2002, Xiph.org Foundation
Redistribution and use in source and binary forms, with or without modification, are permitted provided that the following conditions are met:
 - Redistributions of source code must retain the above copyright notice, this list of conditions and the following disclaimer.
 - Redistributions in binary form must reproduce the above copyright notice, this list of conditions and the following disclaimer in the documentation and/or other materials provided with the distribution.
 - Neither the name of the Xiph.org Foundation nor the names of its contributors may be used to endorse or promote products derived from this software without specific prior written permission.THIS SOFTWARE IS PROVIDED BY THE COPYRIGHT HOLDERS AND CONTRIBUTORS "AS IS" AND ANY EXPRESS OR IMPLIED WARRANTIES, INCLUDING, BUT NOT LIMITED TO, THE IMPLIED WARRANTIES OF MERCHANTABILITY AND FITNESS FOR A PARTICULAR PURPOSE ARE DISCLAIMED. IN NO EVENT SHALL THE FOUNDATION OR CONTRIBUTORS BE LIABLE FOR ANY DIRECT, INDIRECT, INCIDENTAL, SPECIAL, EXEMPLARY, OR CONSEQUENTIAL DAMAGES (INCLUDING, BUT NOT LIMITED TO, PROCUREMENT OF SUBSTITUTE GOODS OR SERVICES; LOSS OF USE, DATA, OR PROFITS; OR BUSINESS INTERRUPTION) HOWEVER CAUSED AND ON ANY THEORY OF LIABILITY, WHETHER IN CONTRACT, STRICT LIABILITY, OR TORT (INCLUDING NEGLIGENCE OR OTHERWISE) ARISING IN ANY WAY OUT OF THE USE OF THIS SOFTWARE, EVEN IF ADVISED OF THE POSSIBILITY OF SUCH DAMAGE.

About this Unit

Information on Disposal of Old Electrical and Electronic Equipment and Batteries (applicable for EU countries that have adopted separate waste collection systems)

Products and batteries with the symbol (crossed-out wheeled bin) cannot be disposed as household waste. Old electrical and electronic equipment and batteries should be recycled at a facility capable of handling these items and their waste byproducts.

Contact your local authority for details in locating a recycle facility nearest to you.

Proper recycling and waste disposal will help conserve resources whilst preventing detrimental effects on our health and the environment.



For Israel

מידע בדבר השלכה לאשפה של ציוד חשמלי

ואלקטרוני ישן וכן סוללות (רלוונטי למדינות

שמשמשות במערכת איסוף אשפה מופרדת).

לא ניתן להשליך מוצרים וסוללות עם הסימון (פח אשפה עם X עליו) כאשפה ביתית רגילה.

יש למחזר ציוד חשמלי ואלקטרוני ישן וכן סוללות במתקן המסוגל לטפל בפריטים כאלה ובתוצרי הלוואי שלהם.

צרו קשר עם הרשות המקומית לקבלת פריטים אודות מתקן המיחזור הקרוב אליכם. מיחזור והשלכה לאשפה נאותים

יעזרו לשמר משאבים ולמנוע השפעות שליליות על בריאותנו ועל הסביבה.



UK CA

Declaration of Conformity with regard to the Radio Equipment Regulations 2017 (S.I. 2017/1206)

Declaration of Conformity with regard to the Restriction of the Use of Certain Hazardous Substances in Electrical and Electronic Equipment Regulations 2012 (S.I. 2012/3032)

Manufacturer:

JVCKENWOOD Corporation

3-12, Moriya-cho, Kanagawa-ku, Yokohama-shi, Kanagawa, 221-0022, JAPAN

UK Importer:

JVCKENWOOD U.K. Limited

First Floor, Gleneagles, the Belfry, Colonial Way, Watford, Hertfordshire WD24 4WH, UNITED KINGDOM

Hereby, JVCKENWOOD declares that the radio equipment "KW-M27DBT" is in compliance with the relevant statutory requirements. The full text of the declaration of conformity is available at the following internet address:
URL: <https://www.jvc.net/cs/car/eudoc/>

About this Unit



**For Europe sales area
Declaration of Conformity with regard to the RE
Directive 2014/53/EU
Declaration of Conformity with regard to the RoHS
Directive 2011/65/EU
Manufacturer:**

JVCKENWOOD Corporation
3-12, Moriyacho, Kanagawa-ku, Yokohama-shi, Kanagawa
221-0022, JAPAN

EU Representative:

JVCKENWOOD Europe B.V.
Amsterdamseweg 37, 1422 AC UITHOORN, THE
NETHERLANDS

English

Hereby, JVCKENWOOD declares that the radio equipment KW-M27DBT is in compliance with Directive 2014/53/EU. The full text of the EU declaration of conformity is available at the following internet address:

Français

Par la présente, JVCKENWOOD déclare que l'équipement radio KW-M27DBT est conforme à la directive 2014/53/UE. L'intégralité de la déclaration de conformité UE est disponible à l'adresse Internet suivante :

Deutsch

Hiermit erklärt JVCKENWOOD, dass das Funkgerät KW-M27DBT der Richtlinie 2014/53/EU entspricht. Der volle Text der EU-Konformitätserklärung steht unter der folgenden Internetadresse zur Verfügung:

Nederlands

Hierbij verklaart JVCKENWOOD dat de radioapparatuur KW-M27DBT in overeenstemming is met Richtlijn 2014/53/EU. De volledige tekst van de EU-verklaring van overeenstemming is te vinden op het volgende internetadres:

Italiano

Con la presente, JVCKENWOOD dichiara che l'apparecchio radio KW-M27DBT è conforme alla Direttiva 2014/53/UE. Il testo integrale della dichiarazione di conformità UE è disponibile al seguente indirizzo internet:

Español

Por la presente, JVCKENWOOD declara que el equipo de radio KW-M27DBT cumple la Directiva 2014/53/EU. El texto completo de la declaración de conformidad con la UE está disponible en la siguiente dirección de internet:

Português

Deste modo, a JVCKENWOOD declara que o equipamento de rádio KW-M27DBT está em conformidade com a Diretiva 2014/53/UE. O texto integral da declaração de conformidade da UE está disponível no seguinte endereço de internet:

Polska

Niniejszym, JVCKENWOOD deklaruje, że sprzęt radiowy KW-M27DBT jest zgodny z dyrektywą 2014/53/UE. Pełny tekst deklaracji zgodności EU jest dostępny pod adresem:

Český

Společnost JVCKENWOOD tímto prohlašuje, že rádiové zařízení KW-M27DBT splňuje podmínky směrnice 2014/53/EU. Plný text EU prohlášení o shodě je dostupný na následující internetové adrese:

Magyar

JVCKENWOOD ezennel kijelenti, hogy a KW-M27DBT rádióberendezés megfelel a 2014/53/EU irányelvnek. Az EU konformitási nyilatkozat teljes szövege az alábbi weboldalon érhető el:

Hrvatski

JVCKENWOOD ovim izjavljuje da je radio oprema KW-M27DBT u skladu s Direktivom 2014/53/EU. Cjeloviti tekst deklaracije Europske unije o usklađenosti dostupan je na sljedećoj internet adresi:

Svenska

Härmed försäkrar JVCKENWOOD att radioutrustningen KW-M27DBT är i enlighet med direktiv 2014/53 / EU. Den fullständiga texten av EU-försäkran om överensstämmelse finns på följande Internetadress :

Suomi

JVCKENWOOD julistaa täten, että radiolaitte KW-M27DBT on direktiivin 2014/53/EU mukainen. EU-vaatimustenmukaisuusvaikutus löytyy kokonaisuudessaan seuraavasta internet-osoitteesta:

Slovensko

S tem JVCKENWOOD izjavlja, da je radijska oprema KW-M27DBT v skladu z Direktivo 2014/53/EU. Celotno besedilo direktive EU o skladnosti je dostopno na tem spletnem naslovu:

URL: <https://www.jvc.net/cs/car/eudoc/>

About this Unit

Slovensky

Spoločnosť JVCKENWOOD týmto vyhlasuje, že rádiové zariadenie KW-M27DBT vyhovuje smernici 2014/53/EÚ. Celý text EÚ vyhlásenia o zhode nájdete na nasledovnej internetovej adrese:

Dansk

Herved erklærer JVCKENWOOD, at radioustyret KW-M27DBT er i overensstemmelse med Direktiv 2014/53/EU. EU-overensstemmelseserklæringens fulde ordlyd er tilgængelig på følgende internetadresse:

Norsk

JVCKENWOOD erklærer herved at radioustyret KW-M27DBT er i samsvar med Direktiv 2014/53/EU. Den fullstendige teksten til EU-konformitetserklæringen er tilgjengelig på følgende internetadresse:

Ελληνικά

Με το παρόν, η JVCKENWOOD δηλώνει ότι ο ραδιοεξοπλισμός KW-M27DBT συμμορφώνεται με την Οδηγία 2014/53/ΕΕ. Το πλήρες κείμενο της δήλωσης συμμόρφωσης της ΕΕ είναι διαθέσιμο στην ακόλουθη διεύθυνση στο διαδίκτυο:

Eesti

Käesolevaga JVCKENWOOD kinnitab, et KW-M27DBT raadiovarustus on vastavuses direktiiviga 2014/53/EL. ELi vastavusdeklaratsiooni terviktekst on kättesaadav järgmisel internetiaadressil:

Latviešu

JVCKENWOOD ar šo deklarē, ka radio aparatūra KW-M27DBT atbilst direktīvas 2014/53/ES prasībām. Pilns ES atbilstības deklarācijas teksts ir pieejams šādā tīmekļa adresē:

Lietuviškai

Šiuo JVCKENWOOD pažymi, kad radijo įranga KW-M27DBT atitinka 2014/53/EB direktyvos reikalavimus. Visą EB direktyvos atitikties deklaracijos tekstą galite rasti šiuo internetiniu adresu:

Malți

B'dan, JVCKENWOOD jiddikjara li t-tagħmir tar-radju KW-M27DBT huwa konformi mad-Direttiva 2014/53/UE. It-test kollu tad-dikjarazzjoni ta' konformità huwa disponibbli fl-indirizz intranet li gej:

Українська

Таким чином, компанія JVCKENWOOD заявляє, що радіобладнання KW-M27DBT відповідає Директиві 2014/53/EU. Повний текст декларації про відповідність ЄС можна знайти в Інтернеті за такою адресою:

Türkçe

Burada, JVCKENWOOD KW-M27DBT radyo ekipmanının 2014/53/AB Direktifine uygun olduğunu bildirir. AB uyumluluk deklarasyonunun tam metni aşağıdaki internet adresinde mevcuttur.

Русский

JVCKENWOOD настоящим заявляет, что радиооборудование KW-M27DBT соответствует Директиве 2014/53/EU. Полный текст декларации соответствия ЕС доступен по следующему адресу в сети Интернет:

Limba română

Prin prezenta, JVCKENWOOD declară că echipamentul radio KW-M27DBT este în conformitate cu Directiva 2014/53/UE. Textul integral al declarației de conformitate UE este disponibil la următoarea adresă de internet:

Български език

С настоящото JVCKENWOOD декларира, че радиооборудването на KW-M27DBT е в съответствие с Директива 2014/53/ЕС. Пълният текст на ЕС декларацията за съответствие е достъпен на следния интернет адрес:

JVC