



ENGLISH
FRANÇAIS
ESPAÑOL

KD-X480BHS / KD-X380BTS

DIGITAL MEDIA RECEIVER

Quick Start Guide

RÉCEPTEUR MULTIMÉDIA NUMÉRIQUE

Guide de démarrage rapide

RECEPTOR DE MEDIOS DIGITALES

Guía de inicio rápido

JVCKENWOOD Corporation

For detailed operations and information, refer to the INSTRUCTION MANUAL on the following website:
Pour les opérations et les informations détaillées, reportez-vous au MANUEL D'INSTRUCTIONS sur le site web suivant:
Para obtener más información y detalles sobre las operaciones, consulte el MANUAL DE INSTRUCCIONES en el siguiente sitio web:

<<https://www.jvc.net/cs/car/>>



For customer Use:

Enter below the Model No. and Serial No. which are located on the top or bottom of the cabinet.
Retain this information for future reference.

Model No. _____

Serial No. _____

Información acerca de la eliminación de equipos eléctricos y electrónicos al final de la vida útil (aplicable a los países que hayan adoptado sistemas independientes de recogida de residuos)



Los productos con el símbolo de un contenedor con ruedas tachado no podrán ser desechados como residuos domésticos. Los equipos eléctricos y electrónicos al final de la vida útil, deberán ser reciclados en instalaciones que puedan dar el tratamiento adecuado a estos productos y a sus subproductos residuales correspondientes. Póngase en contacto con su administración local para obtener información sobre el punto de recogida más cercano. Un tratamiento correcto del reciclaje y la eliminación de residuos ayuda a conservar los recursos y evita al mismo tiempo efectos perjudiciales en la salud y el medio ambiente.

Informação sobre a eliminação de pilhas

Este produto não deve ser eliminado como lixo doméstico geral. Devolva a pilha usada ao revendedor ou entidade autorizada para que a mesma seja devolvida ao fabricante ou importador.

A reciclagem e a eliminação de lixo de maneira apropriada ajudarão a conservar os recursos naturais ao mesmo tempo que prevenirão os efeitos prejudiciais à nossa saúde e ao meio ambiente.

CALIFORNIA, USA ONLY

This product contains a CR Coin Cell Lithium Battery which contains Perchlorate Material—special handling may apply. See www.dtsc.ca.gov/hazardouswaste/perchlorate

FCC CAUTION

Changes or modifications not expressly approved by the party responsible for compliance could void the user's authority to operate the equipment.

NOTE: This equipment has been tested and found to comply with the limits for a Class B digital device, pursuant to part 15 of the FCC Rules. These limits are designed to provide reasonable protection against harmful interference in a residential installation. This equipment generates, uses and can radiate radio frequency energy and, if not installed and used in accordance with the instructions, may cause harmful interference to radio communications. However, there is no guarantee that interference will not occur in a particular installation. If this equipment does cause harmful interference to radio or television reception, which can be determined by turning the equipment off and on, the user is encouraged to try to correct the interference by one or more of the following measures:

- Reorient or relocate the receiving antenna.
- Increase the separation between the equipment and receiver.
- Connect the equipment into an outlet on a circuit different from that to which the receiver is connected.
- Consult the dealer or an experienced radio/TV technician for help.

Supplier's Declaration of Conformity

Trade Name: JVC

Products: DIGITAL MEDIA RECEIVER

Model Name: KD-X480BHS/KD-X380BTS

Responsible Party: JVCKENWOOD USA CORPORATION

4001 Worsham Avenue, Long Beach, CA 90808, U.S.A.

PHONE: 1-800-252-5722

THIS DEVICE COMPLIES WITH PART 15 OF THE FCC RULES. OPERATION IS SUBJECT TO THE FOLLOWING TWO CONDITIONS:

- (1) THIS DEVICE MAY NOT CAUSE HARMFUL INTERFERENCE, AND
- (2) THIS DEVICE MUST ACCEPT ANY INTERFERENCE RECEIVED, INCLUDING INTERFERENCE THAT MAY CAUSE UNDESIRED OPERATION.

ISED Caution

This device contains licence-exempt transmitter(s)/receiver(s) that comply with Innovation, Science and Economic Development Canada's licence-exempt RSS(s). Operation is subject to the following two conditions:

1. This device may not cause interference.
2. This device must accept any interference, including interference that may cause undesired operation of the device.

Attention de l'ISED

L'émetteur/récepteur exempt de licence contenu dans le présent appareil est conforme aux CNR d'Innovation, Sciences et Développement économique Canada applicables aux appareils radio exempts de licence. L'exploitation est autorisée aux deux conditions suivantes :

1. L'appareil ne doit pas produire de brouillage.
2. L'appareil doit accepter tout brouillage radioélectrique subi, même si le brouillage est susceptible d'en compromettre le fonctionnement.

Contains Bluetooth Module	FCC ID:	ZWY88112
	IC ID:	12033A-88112

This transmitter must not be co-located or operated in conjunction with any other antenna or transmitter.

CAUTION

This equipment complies with FCC/ISED radiation exposure limits set forth for an uncontrolled environment and meets the FCC radio frequency (RF) Exposure Guidelines and RSS-102 of the ISED radio frequency (RF) Exposure rules. This equipment should be installed and operated keeping the radiator at least 20 cm or more away from person's body.

ATTENTION

Cet équipement est conforme aux limites d'exposition aux rayonnements énoncées pour un environnement non contrôlé et respecte les règles les radioélectriques (RF) de la FCC lignes directrices d'exposition et d'exposition aux fréquences radioélectriques (RF) CNR-102 de l'ISED. Cet équipement doit être installé et utilisé en gardant une distance de 20 cm ou plus entre le radiateur et le corps humain.

Para cumplimiento de la IFT:

“La operación de este equipo está sujeta a las siguientes dos condiciones:

- (1) es posible que este equipo o dispositivo no cause interferencia perjudicial y
- (2) este equipo o dispositivo debe aceptar cualquier interferencia, incluyendo la que pueda causar su operación no deseada”

SOFTWARE LICENSE AGREEMENT

The software embedded in the Product (hereinafter the "Licensed Software") provided by Licensor is copyrighted to or sublicensable by the Licensor, and this Agreement provides for the terms and conditions which Users shall follow in order to use the Licensed Software.

The User shall use the Licensed Software by agreeing with the terms of this Software License Agreement. This Agreement shall be deemed completed at the time the User (hereinafter the "User") initially used the Product in which the "Licensed Software" is embedded.

The Licensed Software may include the software which has been licensed to the Licensor directly or indirectly from any third party. In such case, some third parties require the Users to follow their conditions for use separately from this Software License Agreement. Such software shall not be subject to this Agreement, and the Users are urged to read the "Important Notice concerning the Software" to be provided separately below.

Article 1 General Provision

The Licensor shall grant to the User a non-exclusive and non-transferable (other than the exceptional case referred to in Article 3, Paragraph 1) licensed to use the Licensed Software within the country of the User. (the country where the User bought the Product (hereinafter the "Country"))

Article 2 License

1. The license granted under this Agreement shall be the right to use the Licensed Software in the Product.
2. The User shall not duplicate, copy, modify, add, translate or otherwise alter, or lease the Licensed Software and any related documents, whether in whole or in part.
3. The use of the Licensed Software shall be limited to personal purpose, and the Licensed Software shall not be distributed, licensed or sub-licensed whether it is for commercial purpose or not.
4. The User shall use the Licensed Software according to the directions described in the operation manual or help file, and is prohibited to use or duplicate any data in a manner violating the Copyright Law or any other laws and regulations by applying whole or a part of the Licensed Software.

Article 3 Conditions for Grant of License

1. When the User transfers the Product, it may also transfer the license to use the Licensed Software embedded in the Product (including any related materials, updates and upgrades) on condition that no original, copies or related materials continue in the possession of the User, and that the User shall cause the transferee to comply with this Software License Agreement.
2. The User shall not carry out reverse engineering, disassembling, decompiling or any other code analysis works in connection with the Licensed Software.

Article 4 Right pertaining to the Licensed Software

Any and all copyrights and other rights pertaining to the Licensed Software and related documents shall belong to the Licensor or the original holder of the right who granted to the Licensor the license or sublicense for the Licensed Software (hereinafter the "Original Rightholder"), and the User shall not be entitled to any right other than the license granted hereunder, in respect of the Licensed Software and any related documents.

Article 5 Indemnification of Licensor

1. Neither the Licensor nor the Original Rightholder shall be liable for any damage incurred by the User or any third party due to the exercise of the license granted to the User under this Agreement, unless otherwise restricted by law.
2. The Licensor will offer no guarantee for the merchantability, convertibility and consistency with certain objective of the Licensed Software.

Article 6 Liability to Third Party

If any dispute has arisen with any third party due to an infringement upon a copyright, patent or any other intellectual property right that was caused by the User's use of the Licensed Software, the User shall settle such dispute at its own cost and hold the Licensor and the Original Rightholder harmless from any inconvenience it may cause.

Article 7 Confidentiality

The User shall keep the confidentiality of such portion of the Licensed Software, related documents thereof or any other information to be granted under this Agreement, as well as the conditions of this Agreement as has not yet entered the public domain, and shall not disclose or divulge the same to any third party without approval of the Licensor.

Article 8 Termination

In case the User falls under any of the events described in the following items, the Licensor may immediately terminate this Agreement or claim that the User compensates for the damage incurred by the Licensor due to such event:

- (1) when the User violated any provision of this Agreement; or
- (2) when a petition has been filed against the User for an attachment, provisional attachment, provisional disposition or any other compulsory execution.

Article 9 Destruction of the Licensed Software

If this Agreement is terminated pursuant to the provision of Article 8, the User shall destroy the Licensed Software, any related documents and copies thereof within two (2) weeks from such date of termination.

Article 10 Protection of Copyright

1. The copyright and all the other intellectual property rights relating to the Licensed Software shall belong to the Licensor and the Original Rightholder, and in no event shall they be under the ownership of the User.
2. The User shall, whenever it uses the Licensed Software, comply with any laws relating to the copyright and other intellectual property rights.

Article 11 Export Restriction

1. It is prohibited to export the Licensed Software and any related documents outside the country of the User (including transmission thereof outside the country of the User via Internet of other communication tools).
2. The User shall understand that the Licensed Software shall be subject to the export restrictions adopted by the country of User and any other countries.
3. The User shall agree that the software will be subject to any and all applicable international and domestic laws (including the export control regulation of the country of User and any other countries, and any restrictions concerning the end-users, the use by end-users and importing countries to be provided by the country of User and any other countries, and any other governmental authorities).

Article 12 Miscellaneous

1. In the event any part of this Agreement is invalidated by operation of law, the residual provisions shall continue in force.
2. Matters not stipulated in this Agreement or any ambiguity or question raised in the construction of this Agreement shall be provided or settled upon good-faith consultation between the Licensor and the User.
3. The Licensor and the User hereby agree that this Agreement is governed by the laws of Japan, and any dispute arising from, and relating to the rights and obligations under, this Agreement shall be submitted to the exclusive jurisdiction of the Tokyo District Court for its first instance.

Important Notice concerning the Software

-jansson

Copyright (c) 2009-2012 Petri Lehtinen <petri@digip.org>

Permission is hereby granted, free of charge, to any person obtaining a copy of this software and associated documentation files (the "Software"), to deal in the Software without restriction, including without limitation the rights to use, copy, modify, merge, publish, distribute, sublicense, and/or sell copies of the Software, and to permit persons to whom the Software is furnished to do so, subject to the following conditions:

The above copyright notice and this permission notice shall be included in all copies or substantial portions of the Software.

THE SOFTWARE IS PROVIDED "AS IS", WITHOUT WARRANTY OF ANY KIND, EXPRESS OR IMPLIED, INCLUDING BUT NOT LIMITED TO THE WARRANTIES OF MERCHANTABILITY, FITNESS FOR A PARTICULAR PURPOSE AND NONINFRINGEMENT. IN NO EVENT SHALL THE AUTHORS OR COPYRIGHT HOLDERS BE LIABLE FOR ANY CLAIM, DAMAGES OR OTHER LIABILITY, WHETHER IN AN ACTION OF CONTRACT, TORT OR OTHERWISE, ARISING FROM, OUT OF OR IN CONNECTION WITH THE SOFTWARE OR THE USE OR OTHER DEALINGS IN THE SOFTWARE.

-cJSON

Copyright (c) 2009 Dave Gamble

Permission is hereby granted, free of charge, to any person obtaining a copy of this software and associated documentation files (the "Software"), to deal in the Software without restriction, including without limitation the rights to use, copy, modify, merge, publish, distribute, sublicense, and/or sell copies of the Software, and to permit persons to whom the Software is furnished to do so, subject to the following conditions:

The above copyright notice and this permission notice shall be included in all copies or substantial portions of the Software.

THE SOFTWARE IS PROVIDED "AS IS", WITHOUT WARRANTY OF ANY KIND, EXPRESS OR IMPLIED, INCLUDING BUT NOT LIMITED TO THE WARRANTIES OF MERCHANTABILITY, FITNESS FOR A PARTICULAR PURPOSE AND NONINFRINGEMENT. IN NO EVENT SHALL THE AUTHORS OR COPYRIGHT HOLDERS BE LIABLE FOR ANY CLAIM, DAMAGES OR OTHER LIABILITY, WHETHER IN AN ACTION OF CONTRACT, TORT OR OTHERWISE, ARISING FROM, OUT OF OR IN CONNECTION WITH THE SOFTWARE OR THE USE OR OTHER DEALINGS IN THE SOFTWARE.

-CMP

The MIT License (MIT)

Copyright (c) 2014 Charles Gunyon

Permission is hereby granted, free of charge, to any person obtaining a copy of this software and associated documentation files (the "Software"), to deal in the Software without restriction, including without limitation the rights to use, copy, modify, merge, publish, distribute, sublicense, and/or sell copies of the Software, and to permit persons to whom the Software is furnished to do so, subject to the following conditions:

The above copyright notice and this permission notice shall be included in all copies or substantial portions of the Software.

THE SOFTWARE IS PROVIDED "AS IS", WITHOUT WARRANTY OF ANY KIND, EXPRESS OR IMPLIED, INCLUDING BUT NOT LIMITED TO THE WARRANTIES OF MERCHANTABILITY, FITNESS FOR A PARTICULAR PURPOSE AND NONINFRINGEMENT. IN NO EVENT SHALL THE AUTHORS OR COPYRIGHT HOLDERS BE LIABLE FOR ANY CLAIM, DAMAGES OR OTHER LIABILITY, WHETHER IN AN ACTION OF CONTRACT, TORT OR OTHERWISE, ARISING FROM, OUT OF OR IN CONNECTION WITH THE SOFTWARE OR THE USE OR OTHER DEALINGS IN THE SOFTWARE.

nanopb

Copyright (c) 2011 Petteri Aimonen <jpa at nanopb.mail.kapsi.fi>

This software is provided 'as-is', without any express or implied warranty. In no event will the authors be held liable for any damages arising from the use of this software.

Permission is granted to anyone to use this software for any purpose, including commercial applications, and to alter it and redistribute it freely, subject to the following restrictions:

1. The origin of this software must not be misrepresented; you must not claim that you wrote the original software. If you use this software in a product, an acknowledgment in the product documentation would be appreciated but is not required.
 2. Altered source versions must be plainly marked as such, and must not be misrepresented as being the original software.
 3. This notice may not be removed or altered from any source distribution.
-

sha2

AUTHOR: Aaron D. Gifford - <http://www.aarongifford.com/>

Copyright (c) 2000-2001, Aaron D. Gifford
All rights reserved.

You may obtain a copy of the license at
<https://opensource.org/licenses/BSD-3-Clause>

THE SOFTWARE IS PROVIDED "AS IS", WITHOUT WARRANTY OF ANY KIND, EXPRESS OR IMPLIED, INCLUDING BUT NOT LIMITED TO THE WARRANTIES OF MERCHANTABILITY, FITNESS FOR A PARTICULAR PURPOSE AND NONINFRINGEMENT. IN NO EVENT SHALL THE AUTHORS OR COPYRIGHT HOLDERS BE LIABLE FOR ANY CLAIM, DAMAGES OR OTHER LIABILITY, WHETHER IN AN ACTION OF CONTRACT, TORT OR OTHERWISE, ARISING FROM, OUT OF OR IN CONNECTION WITH THE SOFTWARE OR THE USE OR OTHER DEALINGS IN THE SOFTWARE.

Posix

Copyright (c) 1990, 1993

The Regents of the University of California. All rights reserved.

Redistribution and use in source and binary forms, with or without modification, are permitted provided that the following conditions are met:

1. Redistributions of source code must retain the above copyright notice, this list of conditions and the following disclaimer.
2. Redistributions in binary form must reproduce the above copyright notice, this list of conditions and the following disclaimer in the documentation and/or other materials provided with the distribution.
3. All advertising materials mentioning features or use of this software must display the following acknowledgement:
This product includes software developed by the University of California, Berkeley and its contributors.
4. Neither the name of the University nor the names of its contributors may be used to endorse or promote products derived from this software without specific prior written permission.

Copyright (C) 1993 by Sun Microsystems, Inc. All rights reserved.

Developed at SunPro, a Sun Microsystems, Inc. business.

Permission to use, copy, modify, and distribute this software is freely granted, provided that this notice is preserved.

Copyright (C) 1991-2, RSA Data Security, Inc. Created 1991. All rights reserved.

License to copy and use this software is granted provided that it is identified as the "RSA Data Security, Inc. MD4 Message-Digest Algorithm" in all material mentioning or referencing this software or this function.

Copyright (c) 1995, 1996 Carnegie-Mellon University. All rights reserved.

Author: Chris G. Demetriou

Permission to use, copy, modify and distribute this software and its documentation is hereby granted, provided that both the copyright notice and this permission notice appear in all copies of the software, derivative works or modified versions, and any portions thereof, and that both notices appear in supporting documentation.

CARNEGIE MELLON ALLOWS FREE USE OF THIS SOFTWARE IN ITS "AS IS" CONDITION. CARNEGIE MELLON DISCLAIMS ANY LIABILITY OF ANY KIND FOR ANY DAMAGES WHATSOEVER RESULTING FROM THE USE OF THIS SOFTWARE.

Carnegie Mellon requests users of this software to return to

Software Distribution Coordinator or Software.Distribution@

CS.CMU.EDU

School of Computer Science

Carnegie Mellon University

Pittsburgh PA 15213-3890

any improvements or extensions that they make and grant Carnegie the rights to redistribute these changes.

License is also granted to make and use derivative works provided that such works are identified as "derived from the RSA Data Security, Inc. MD4 Message-Digest Algorithm" in all material mentioning or referencing the derived work.

RSA Data Security, Inc. makes no representations concerning either the merchantability of this software or the suitability of this software for any particular purpose. It is provided "as is" without express or implied warranty of any kind.

Copyright (c) 1993 Martin Birgmeier

All rights reserved.

You may redistribute unmodified or modified versions of this source code provided that the above copyright notice and this and the following conditions are retained.

This software is provided "as is", and comes with no warranties of any kind. I shall in no event be liable for anything that happens to anyone/anything when using this software.
These notices must be retained in any copies of any part of this documentation and/or software.

T-Kernel 2.0

This product uses the source code of T-Kernel 2.0 under T-License 2.0 granted by T-Engine Forum (www.tron.org)

BSD-3-Clause

Copyright (c) 2000-2001, Aaron D. Gifford

All rights reserved.

You may obtain a copy of the license at

<https://opensource.org/licenses/BSD-3-Clause>

THE SOFTWARE IS PROVIDED "AS IS", WITHOUT WARRANTY OF ANY KIND, EXPRESS OR IMPLIED, INCLUDING BUT NOT LIMITED TO THE WARRANTIES OF MERCHANTABILITY, FITNESS FOR A PARTICULAR PURPOSE AND NONINFRINGEMENT. IN NO EVENT SHALL THE AUTHORS OR COPYRIGHT HOLDERS BE LIABLE FOR ANY CLAIM, DAMAGES OR OTHER LIABILITY, WHETHER IN AN ACTION OF CONTRACT, TORT OR OTHERWISE, ARISING FROM, OUT OF OR IN CONNECTION WITH THE SOFTWARE OR THE USE OR OTHER DEALINGS IN THE SOFTWARE.

LFS Subsystem

Copyright The Regents of the University of California. All rights reserved.

You may obtain a copy of the license at

<https://directory.fsf.org/wiki/License:BSD-4-Clause>

THE SOFTWARE IS PROVIDED "AS IS", WITHOUT WARRANTY OF ANY KIND, EXPRESS OR IMPLIED, INCLUDING BUT NOT LIMITED TO THE WARRANTIES OF MERCHANTABILITY, FITNESS FOR A PARTICULAR PURPOSE AND NONINFRINGEMENT. IN NO EVENT SHALL THE AUTHORS OR COPYRIGHT HOLDERS BE LIABLE FOR ANY CLAIM, DAMAGES OR OTHER LIABILITY, WHETHER IN AN ACTION OF CONTRACT, TORT OR OTHERWISE, ARISING FROM, OUT OF OR IN CONNECTION WITH THE SOFTWARE OR THE USE OR OTHER DEALINGS IN THE SOFTWARE.

Accordo2 Player

Apache License

Licensed under the Apache License,

Version 2.0, January 2004 (the "License");

You may obtain a copy of the license at

<http://www.apache.org/licenses/LICENSE-2.0>

THE SOFTWARE IS PROVIDED "AS IS", WITHOUT WARRANTY OF ANY KIND, EXPRESS OR IMPLIED, INCLUDING BUT NOT LIMITED TO THE WARRANTIES OF MERCHANTABILITY, FITNESS FOR A PARTICULAR PURPOSE AND NONINFRINGEMENT. IN NO EVENT SHALL THE AUTHORS OR COPYRIGHT HOLDERS BE LIABLE FOR ANY CLAIM, DAMAGES OR OTHER LIABILITY, WHETHER IN AN ACTION OF CONTRACT, TORT OR OTHERWISE, ARISING FROM, OUT OF OR IN CONNECTION WITH THE SOFTWARE OR THE USE OR OTHER DEALINGS IN THE SOFTWARE.

Installation/Connection

This section is for the professional installer.

For safety's sake, leave wiring and mounting to professionals. Consult the car audio dealer.

▲ WARNING

- The unit can only be used with a 12 V DC power supply, negative ground.
- Disconnect the battery's negative terminal before wiring and mounting.
- Do not connect Battery wire (yellow) and Ignition wire (red) to the car chassis or Ground wire (black) to prevent a short circuit.
- To prevent short circuit:
 - Insulate unconnected wires with vinyl tape.
 - Be sure to ground this unit to the car's chassis again after installation.
 - Secure the wires with cable clamps and wrap vinyl tape around the wires that comes into contact with metal parts to protect the wires.

▲ CAUTION

- Install this unit in the console of your vehicle. Do not touch the metal parts of this unit during and shortly after use of the unit. Metal parts such as the heat sink and enclosure become hot.
- Do not connect the \ominus wires of speakers to the car chassis or Ground wire (black), or connect them in parallel.
- Connect speakers with a maximum power of more than 50 W. If the maximum power of the speakers is lower than 50 W, change the [AMP GAIN] setting to avoid damaging the speakers.
- Mount the unit at an angle of less than 30°.
- If your vehicle wiring harness does not have the ignition terminal, connect Ignition wire (red) to the terminal on the vehicle's fuse box which provides 12 V DC power supply and is turned on and off by the ignition key.
- Keep all cables away from heat dissipate metal parts.
- After the unit is installed, check whether the brake lamps, blinkers, wipers, etc. on the car are working properly.
- If the fuse blows, first make sure the wires are not touching car's chassis, then replace the old fuse with one that has the same rating.

■ Basic procedure

- 1 Remove the key from the ignition switch, then disconnect the \ominus terminal of the car battery.
- 2 Connect the wires properly. See "Wiring connection" on page 3.
- 3 Install the unit to your car. See the following "Installing the unit (in-dash mounting)".
- 4 Connect the \ominus terminal of the car battery.
- 5 Press \odot SRC to turn on the power.
- 6 Detach the faceplate and reset the unit within 5 seconds. See "How to reset" on page 4.

Installing the unit (in-dash mounting)

1

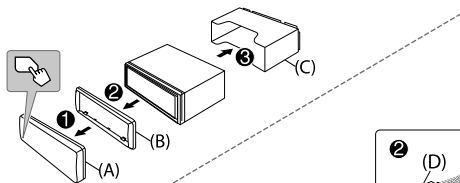

2

Hook on the top side

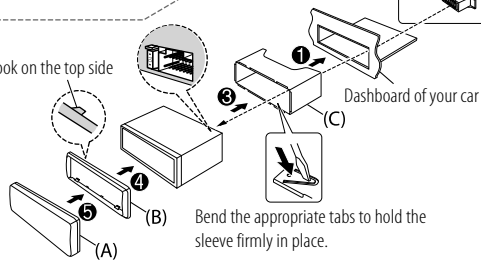

Installing the unit (without mounting sleeve)

- 1 Remove the mounting sleeve and trim plate from the unit.
- 2 Align the holes in the unit (on both sides) with the vehicle mounting bracket and secure the unit with screws (commercially available).

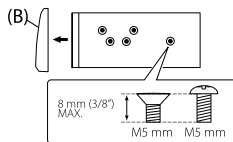

▲ Use only the specified screws.
Using wrong screws might damage the unit.

Removing the unit

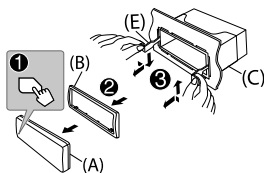

Part list (supplied)

- (A) Faceplate (x1)
- (B) Trimplate (x1)
- (C) Mounting sleeve (x1)
- (D) Wiring harness (x1)
- (E) Extraction key (x2)

Wiring connection

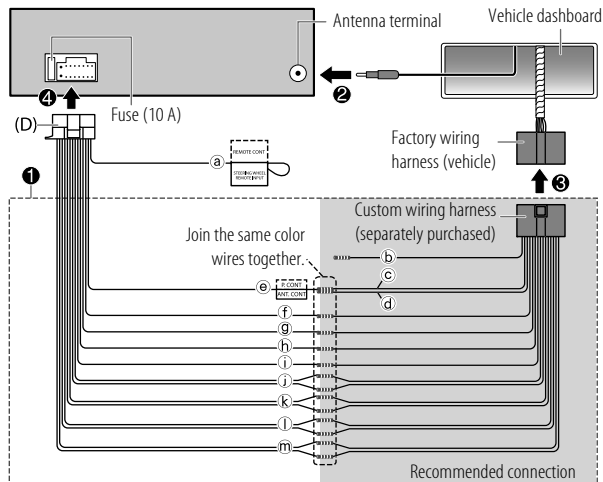

- Ⓐ Light blue/yellow: To the steering wheel remote control adapter
- Ⓑ Brown (not used)
- Ⓒ Blue: To power antenna
- Ⓓ Blue/white: To amplifier
- Ⓔ Blue/white: Remote (12 V \approx 350 mA)
- Ⓕ Orange/white: Illumination
- Ⓖ Yellow: Battery 12 V
- Ⓗ Red: Ignition 12 V
- Ⓘ Black: Ground
- ⓷ Gray ⊕, Gray/black ⊖: Front speaker (right)
- Ⓚ White ⊕, White/black ⊖: Front speaker (left)
- Ⓛ Purple ⊕, Purple/black ⊖: Rear speaker (right)
- Ⓜ Green ⊕, Green/black ⊖: Rear speaker (left)

Before Use

IMPORTANT

- To ensure proper use, please read through this Guide before using this product. It is especially important that you read and observe Warnings and Cautions in this Guide.
- Please keep the Guide in a safe and accessible place for future reference.

▲ WARNING

Do not operate any function that takes your attention away from safe driving.

▲ CAUTION

Volume setting:

- Adjust the volume so that you can hear sounds outside the car to prevent accidents.
- Lower the volume before playing digital sources to avoid damaging the speakers by the sudden increase of the output level.

General:



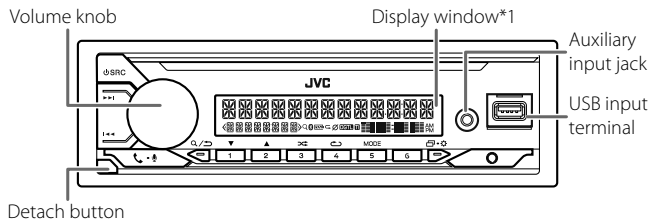

- Avoid using the external device if it might hinder safe driving.
- Make sure all important data has been backed up. We shall bear no responsibility for any loss of recorded data.
- Never put or leave any metallic objects (such as coins or metal tools) inside the unit to prevent a short circuit.
- Depending on the types of cars, the antenna will automatically extend when you turn on the unit with the antenna control wire connected. Turn off the unit when parking at a low ceiling area.

Basics

Faceplate

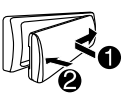

*1 Only for illustration purpose.

To	On the faceplate
Attach 	How to reset  Reset the unit within 5 seconds after detaching the faceplate.
Turn on the power	Press  SRC. • Press and hold to turn off the power.
Adjust the volume	Turn the volume knob.
Select a source	Press  SRC repeatedly.
Change the display information*2	Press  repeatedly.

*2 One of the display information supports Music Synchronization Effect. The illumination color or brightness level of the buttons changes and synchronizes with the music level.

Getting Started

1 Acknowledge the crossover type and cancel the demonstration

When you turn on the power for the first time (or [FACTORY RESET] is set to [YES]), the display shows: "2-WAY X'OVER" or "3-WAY X'OVER" → "PRESS" → "VOLUME KNOB" → "TO CONFIRM".

- 1 Press the volume knob to acknowledge the current crossover type.
Then, the display shows: "CANCEL DEMO" → "PRESS" → "VOLUME KNOB"
- 2 Press the volume knob.
[YES] is selected for the initial setup.
- 3 Press the volume knob again.
"DEMO OFF" appears.

2 Set the clock and date

- 1 Press and hold + .
- 2 Turn the volume knob to select [CLOCK], then press the knob.

To adjust the clock

- 3 Turn the volume knob to select [CLOCK ADJUST], then press the knob.
- 4 Turn the volume knob to make the settings, then press the knob.
Set the time in the order of "Hour" → "Minute".
- 5 Turn the volume knob to select [CLOCK FORMAT], then press the knob.
- 6 Turn the volume knob to select [12H] or [24H], then press the knob.

To set the date

- 7 Turn the volume knob to select [DATE SET], then press the knob.
- 8 Turn the volume knob to make the settings, then press the knob.
Set the date in the order of "Day" → "Month" → "Year".
- 9 Press + to exit.

To return to the previous setting item, press / .

3 Set the basic settings

- 1 Press and hold + .
- 2 Turn the volume knob to select an item (see the following table), then press the knob.
- 3 Repeat step 2 until the desired item is selected or activated.
- 4 Press + to exit.

To return to the previous setting item, press / .

Default: [XX]

[SYSTEM]	
[KEY BEEP]	(Not applicable when 3-way crossover is selected.) [ON]: Activates the keypress tone. ; [OFF]: Deactivates.
[FACTORY RESET]	[YES]: Resets the settings to default (except the stored station). ; [NO]: Cancels.
[CLOCK]	
[CLOCK DISPLAY]	[ON]: The clock time is shown on the display even when the unit is turned off. ; [OFF]: Cancels.
[ENGLISH]	Select the display language for menu and music information if applicable.
[ESPANOL]	By default, [ENGLISH] is selected.
[FRANCAIS]	

HD Radio™ Tuner/Radio

For KD-X480BHS, you can tune in to both conventional and HD Radio broadcasts.

■ Search for a station or channel

- 1 Press repeatedly to select FM or AM.
- 2 For KD-X480BHS: Press and hold to select the tuning mode.
 - [HD SEEK]: Search for HD Radio broadcast only.
 - [MANUAL SEEK]: Search for both conventional and HD Radio broadcasts.
- 3 Press / to search for a station or channel automatically.
(or)
Press and hold / until "M" flashes, then press repeatedly to search for a station or channel manually.

■ Settings in memory

For KD-X480BHS, you can store up to 18 stations/channels for FM and 6 stations/channels for AM.

For KD-X380BTS, you can store up to 18 stations for FM and 6 stations for AM.

Store a station or channel

While listening to a station or channel....

Press and hold one of the number buttons (1 to 6).

(or)

- 1 Press and hold the volume knob until "PRESET MODE" flashes.
- 2 Turn the volume knob to select a preset number, then press the knob.
"MEMORY" appears once the station or channel is stored.

Select a stored station or channel

Press one of the number buttons (1 to 6).

(or)

- 1 Press .
- 2 For KD-X480BHS: Turn the volume knob to select [PRESET LIST], then press the knob.
- 3 Turn the volume knob to select a preset number, then press the knob.

USB/iPod

Selectable source:

- USB/iPod USB or iPod BT

■ Start playback

The source changes automatically and playback starts when you attach a device (USB device/ iPod/iPhone) to the USB input terminal.

- Be sure [USB] is selected for [IPHONE SETUP] in [USB] menu for listening to iPod/iPhone.

To	On the faceplate
Reverse/Fast-forward	Press and hold / .
Select a file	Press / .
Select a folder	Press 2▲ / 1▼.
Repeat play	Press 4 repeatedly.
Random play	Press 3 repeatedly.

Menu Settings

- 1 Press and hold + to enter menu settings.
- 2 Turn the volume knob to select an item, then press the knob.
- 3 Repeat step 2 until the desired item is selected/activated.
- 4 Press + to exit.

To return to the previous setting item, press .

- Refer to the INSTRUCTION MANUAL on the following website for the detailed explanation of each item: <<https://www.jvc.net/cs/car/>>
- The availability of each item vary depending on the model.

Menu items

- [EQ SETTING] : Selects a preset equalizer or adjusts your own sound settings.
- [AUDIO CONTROL] : Sets your preferred audio settings.
- [SOUND EFFECT] : Sets your preferred sound effect.
- [DISPLAY] : Sets your preferred control for the display window.
- [COLOR] : Sets your preferred illumination color for buttons.
- [TUNER SETTING] : Settings for radio source.
- [SIRIUS XM] : Settings for Sirius XM tuner.
- [USB] : Sets iPod/iPhone playback source (via USB input terminal or via Bluetooth).
- [BT MODE] : Settings for using a Bluetooth device.
- [REMOTE APP] : Settings for using smartphone to control this unit.
- [ALEXA SETUP] : Sets your preferred voice control language for Alexa.
- [MIC GAIN]* : Sets the sensitivity of the microphone.
- [NR LEVEL]* : Adjusts the noise reduction level.
- [ECHO CANCEL]* : Adjusts the echo cancellation delay time.
- [SYSTEM] : Settings for this unit.
- [CLOCK] : Adjusts the clock.
- [ENGLISH] : Selects language for the menu and music information.
- [ESPANOL] : Selects language for the menu and music information.
- [FRANCAIS] : Selects language for the menu and music information.
- [DEMO MODE] : Activates or deactivates the display demonstration.

* Applicable only while talking on the phone.

Examples of some well-used settings

■ Subwoofer Level Setting

- 1 Press and hold + to enter menu settings.



- 2 Turn the volume knob clockwise to select [AUDIO CONTROL], then press the knob.



- 3 Turn the volume knob clockwise to select [SUBWOOFER SET], then press the knob.

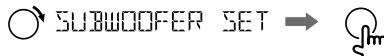

- 4 Turn the volume knob clockwise to select [ON], then press the knob.

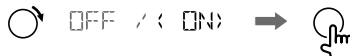

- 5 Turn the volume knob clockwise to select [SUB.W LEVEL], then press the knob.



- 6 Press the volume knob if [PRE-OUT] is shown on the display.



- 7 Turn the volume knob to adjust the subwoofer level, then press the knob.

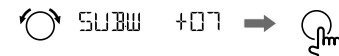

Continued on the next page...



- 8 Press  +  to exit the setting menu.

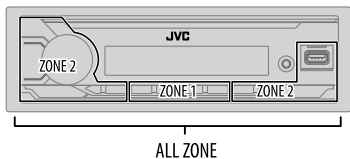

■ Illumination Color Setting

You can set your preferred illumination color for each zone.



- 1 Press and hold  +  to enter menu settings.



- 2 Turn the volume knob clockwise to select [COLOR], then press the knob.



- 3 Press the volume knob if [PRESET] is shown on the display.



- 4 Turn the volume knob to choose a zone ([ALL ZONE], [ZONE 1], [ZONE 2]), then press the knob.



- 5 Turn the volume knob to choose a color, then press the knob.



- [COLOR 01] to [COLOR 49]
- [USER]: The color you have created for [DAY COLOR] or [NIGHT COLOR] is shown.
- [COLOR FLOW01] to [COLOR FLOW03]: Color changes at different speeds.
- [CRYSTAL]/[FLOWER]/[FOREST]/[GRADATION]/[OCEAN]/[RELAX]/[SUNSET]: The selected color pattern is shown. (Selectable only when [ALL ZONE] is selected in step 4.)

- 6 Repeat step 4 and step 5 to set color for other zones.

- 7 Press  +  to exit.



Other Information

For playback operations of **AUX, SiriusXM® Radio** and **AMAZON ALEXA** sources, refer to the INSTRUCTION MANUAL on the following website:

<<https://www.jvc.net/cs/car/>>

- The availability of each source vary depending on the model.

Note for specifications

Bluetooth Frequency Range:

2.402 GHz — 2.480 GHz

Bluetooth RF Output Power (E.I.R.P.):

+4 dBm (MAX), Power Class 2

Speaker Impedance:

4 Ω — 8 Ω

Operating Voltage:

12 V DC car battery

Bluetooth®

- Depending on the Bluetooth version, operating system and the firmware version of your mobile phone, Bluetooth features may not work with this unit.
- Be sure to turn on the Bluetooth function of the device to make the following operations.
- Signal conditions vary depending on the surroundings.

■ Connect the microphone

Connect the supplied microphone to the microphone input jack on the rear panel.

Adjust the microphone angle

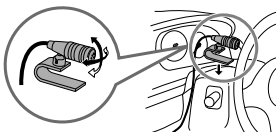

Secure using cord clamps (not supplied) if necessary.

■ Pair and connect a Bluetooth device for the first time

- 1 Press **⏻**/SRC to turn on the unit.
- 2 Search and select the name of your receiver ("KD-X480BHS"/"KD-X380BTS") on the Bluetooth device.
- 3 Perform (A) or (B) depending on what appears on the display.
For some Bluetooth devices, pairing sequence may vary from the steps described below.

(A) "[Device Name]" → "XXXXXX" → "VOL – YES" → "BACK – NO"
"XXXXXX" is a 6-digit passkey randomly generated during each pairing.

- 1 Ensure that the passkeys appear on the unit and Bluetooth device are the same.
- 2 Press the volume knob to confirm the passkey.
- 3 Operate the Bluetooth device to confirm the passkey.

(B) "[Device Name]" → "VOL – YES" → "BACK – NO"

- 1 Press the volume knob to start pairing.
- 2 • If "PAIRING" → "PIN 0000" scrolls on the display, enter the PIN code "0000" into the Bluetooth device.
 - If only "PAIRING" appears, operate the Bluetooth device to confirm pairing.

"PAIRING COMPLETED" appears when pairing is completed and **📶** will light up when the Bluetooth connection is established.

■ Answer a call

Press **📞** – **🔊** or the volume knob.

- To adjust the phone volume [00] to [35], turn the volume knob.
- To end a call, press and hold **📞** – **🔊** or the volume knob.

■ Audio player via Bluetooth

- 1 Press **⏻**/SRC repeatedly to select BT AUDIO.
- 2 Operate the audio player via Bluetooth to start playback.

To	On the faceplate
Play back/pause	Press the volume knob.
Select group or folder	Press 2▲ / 1▼.
Reverse skip/Forward skip	Press ⏮ / ⏭ .
Reverse/Fast-forward	Press and hold ⏮ / ⏭ .
Repeat play	Press 4🔄 repeatedly.
Random play	Press 3🔀 repeatedly.

Installation/Connexion

Cette section est réservée aux installateurs professionnels.

Pour des raisons de sécurité, laissez le travail de câblage et de montage des professionnels. Consultez votre revendeur autoradio.

▲ MISE EN GARDE

- L'appareil peut uniquement être utilisé avec une alimentation de 12 V CC, à masse négative.
- Déconnectez la borne négative de la batterie avant le câblage et le montage.
- Ne connectez pas le fil de batterie (jaune) et le fil d'allumage (rouge) au châssis de la voiture ou au fil de masse (noir) pour éviter les courts-circuits.
- Pour éviter les courts-circuits:
 - Isolez les fils non connectés avec du ruban adhésif.
 - Assurez-vous de raccorder de nouveau la mise à la masse de cet appareil au châssis de la voiture après l'installation.
 - Fixez les câbles avec des serre-câbles et enroulez un ruban de vinyle autour des câbles qui entrent en contact avec des pièces métalliques pour protéger les câbles.

▲ AVERTISSEMENT

- Installez cet appareil dans la console de votre véhicule. Ne touchez pas les parties métalliques de cet appareil pendant ou juste après son utilisation. Les parties métalliques, comme le dissipateur de chaleur et le boîtier, deviennent chaudes.
- Ne connectez pas les fils \ominus des enceintes au châssis de la voiture, au fil de masse (noir) ou en parallèle.
- Connectez des enceintes avec une puissance maximum de plus de 50 W. Si la puissance maximum des enceintes est inférieure à 50 W, changez le réglage [AMP GAIN] pour éviter d'endommager les enceintes.
- Montez l'appareil avec un angle de moins de 30°.
- Si le faisceau de fils de votre véhicule ne possède pas de borne d'allumage, connectez le fil d'allumage (rouge) à la borne du boîtier de fusible de votre véhicule qui offre une alimentation de 12 V CC et qui se met en et hors service avec la clé de contact.
- Gardez tous les câbles à l'écart des dissipateurs thermiques.
- Après avoir installé l'appareil, vérifiez si les lampes de frein, les indicateurs, les clignotants, les essuie-glaces, etc. de la voiture fonctionnent correctement.
- Si un fusible saute, assurez-vous d'abord que les câbles ne touchent pas le châssis de la voiture puis remplacez le vieux fusible par un nouveau de même valeur.

■ Procédure de base

- 1 Retirez la clé de contact, puis déconnectez la borne \ominus de la batterie de la voiture.
- 2 Connectez les fils correctement. Voir "Connexions" à la page 3.
- 3 Installez l'appareil dans votre voiture. Reportez-vous à "Installation de l'appareil (montage encastré)" ci-après.
- 4 Connectez la borne \ominus de la batterie de la voiture.
- 5 Appuyez sur \odot SRC pour mettre l'appareil sous tension.
- 6 Détachez la façade et réinitialisez l'appareil avant 5 secondes. Voir "Comment réinitialiser" à la page 4.

Installation de l'appareil (montage encastré)

1

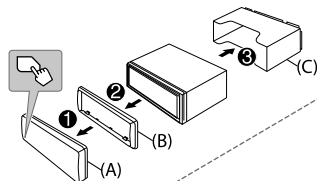

2

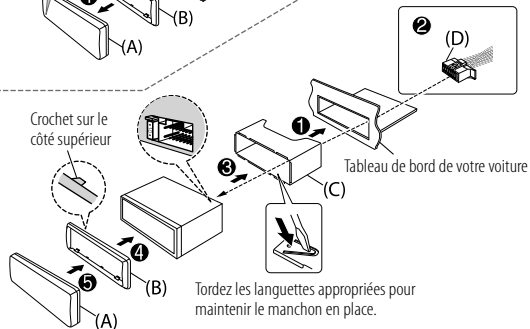

Installation de l'appareil (sans le manchon de montage)

- 1 Retirez le manchon de montage et la plaque de garniture de l'appareil.
- 2 Alignez les entailles de l'appareil (des deux côtés) avec le support de montage du véhicule et fixez l'appareil avec les vis (en vente dans le commerce).

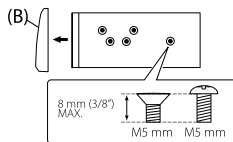

⚠ N'utiliser que les vis spécifiés.
L'utilisation de vis incorrects peut endommager l'appareil.

Retrait de l'appareil

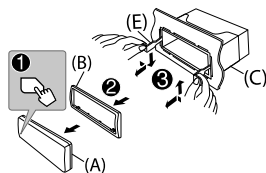

■ Liste de pièces (fourni)

- (A) Façade (x1)
- (B) Plaque de garniture (x1)
- (C) Manchon de montage (x1)
- (D) Faisceau de fils (x1)
- (E) Clé d'extraction (x2)

Connexions

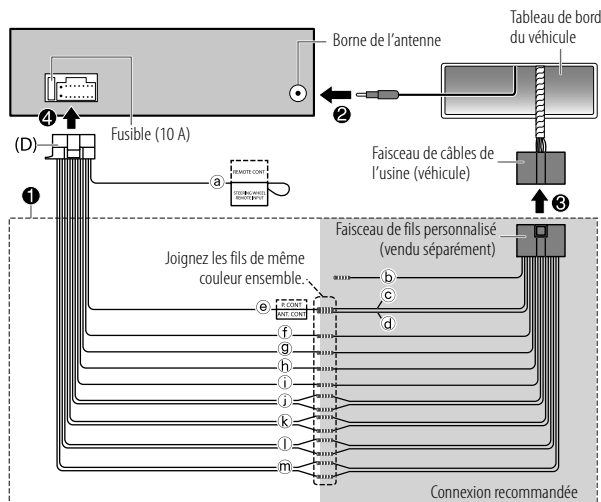

- a Bleu clair/jaune: À l'adaptateur de télécommande volant
- b Marron (non utilisé)
- c Bleu: À l'antenne alimentée
- d Bleu/blanc: À l'amplificateur
- e Bleu/blanc: Télécommande (12 V \approx 350 mA)
- f Orange/blanc: Éclairage
- g Jaune: Batterie 12 V
- h Rouge: Allumage 12 V
- i Noir: Masse
- j Gris ⊕, Gris/noir ⊖: Enceinte avant (droite)
- k Blanc ⊕, Blanc/noir ⊖: Enceinte avant (gauche)
- l Violet ⊕, Violet/noir ⊖: Enceinte arrière (droite)
- m Vert ⊕, Vert/noir ⊖: Enceinte arrière (gauche)

Avant l'utilisation

IMPORTANTES

- Pour utiliser correctement l'appareil, veuillez lire ce Guide complétement avant de l'utiliser. Il est particulièrement important que vous lisiez et acceptiez les avertissements et les précautions de ce Guide.
- Veuillez garder ce Guide dans un endroit sûr et accessible pour une utilisation future.

▲ MISE EN GARDE

N'utilisez aucune fonction qui risque de vous distraire de la conduite sûre de votre véhicule.

▲ AVERTISSEMENT

Réglage du volume:

- Ajustez le volume de façon à pouvoir entendre les sons extérieurs à la voiture afin d'éviter tout risque d'accident.
- Réduisez le volume avant de reproduire des sources numériques afin d'éviter d'endommager les enceintes par la soudaine augmentation du niveau de sortie.

Généralités:





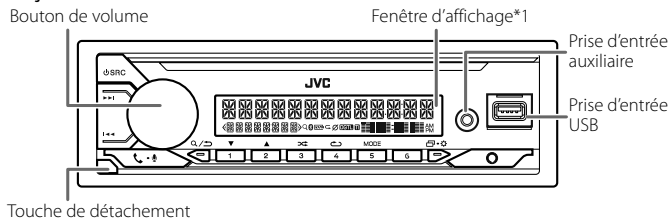

- Éviter d'utiliser le périphérique extérieur s'il peut gêner une conduite en toute sécurité.
- Assurez-vous que toutes les données importantes ont été sauvegardées. Nous ne pouvons pas être tenu responsable pour toute perte des données enregistrées.
- Veuillez faire en sorte de ne jamais mettre ou laisser d'objets métalliques (tels que des pièces ou des outils) dans l'appareil, afin d'éviter tout risque de court-circuit.
- En fonction du type de voiture, l'antenne s'étendra automatiquement quand vous mettrez l'appareil sous tension si le câble de commande d'antenne est connecté. Mettez l'appareil hors tension quand vous vous garez dans un parking avec un plafond bas.

Fonctionnement de base

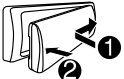
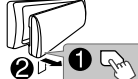
Façade



*1 Uniquement à des fins d'illustration.

Attachez	Détachez	Comment réinitialiser
		 Réinitialisez l'appareil en moins de 5 secondes après avoir détaché la façade.
Pour	Sur la façade	
Mettez l'appareil sous tension	Appuyez sur  SRC. • Maintenez la touche enfoncée pour mettre l'appareil hors tension.	
Ajustez le volume	Tournez le bouton de volume.	
Sélectionner la source	Appuyez répétitivement sur  SRC.	
Changez l'information sur l'affichage*2	Appuyez répétitivement sur   .	

*2 Une des informations de l'affichage prend en charge l'effet de synchronisation musicale. La couleur d'éclairage ou le niveau de luminosité des touches change et est synchronisé avec le niveau de la musique.



Prise en main

1 Vérifiez le type de transition et annulez la démonstration

Quand vous mettez l'appareil sous tension pour la première fois (ou que [FACTORY RESET] est réglé sur [YES]), l'affichage montre: "2-WAY X'OVER" ou "3-WAY X'OVER" → "PRESS" → "VOLUME KNOB" → "TO CONFIRM".

- 1 Appuyez sur le bouton de volume pour valider le type de transition actuel. Puis, l'affichage montre: "CANCEL DEMO" → "PRESS" → "VOLUME KNOB"
- 2 Appuyez sur le bouton de volume. [YES] est choisi pour le réglage initial.
- 3 Appuyez de nouveau sur le bouton de volume. "DEMO OFF" apparaît.



2 Réglez l'horloge et la date

- 1 Maintenez enfoncée  + .
- 2 Tournez le bouton de volume pour choisir [CLOCK], puis appuyez sur le bouton.

Pour ajuster l'horloge





- 3 Tournez le bouton de volume pour choisir [CLOCK ADJUST], puis appuyez sur le bouton.
- 4 Tournez le bouton de volume pour faire les réglages, puis appuyez sur le bouton. Réglez l'heure dans l'ordre "Heures" → "Minutes".
- 5 Tournez le bouton de volume pour choisir [CLOCK FORMAT], puis appuyez sur le bouton.
- 6 Tournez le bouton de volume pour choisir [12H] ou [24H], puis appuyez sur le bouton.

Pour régler la date

- 7 Tournez le bouton de volume pour choisir [DATE SET], puis appuyez sur le bouton.
- 8 Tournez le bouton de volume pour faire les réglages, puis appuyez sur le bouton. Réglez la date dans l'ordre "Jour" → "Mois" → "Année".
- 9 Appuyez sur  +  pour quitter.

Pour retourner à l'option de réglage précédente, appuyez sur .

3 Faites les réglages de base

- 1 Maintenez enfoncée  + .
- 2 Tournez le bouton de volume pour sélectionner un élément (voir le tableau suivant), puis appuyez sur le bouton.
- 3 Répétez l'étape 2 jusqu'à ce que l'élément souhaité soit sélectionné ou activé.
- 4 Appuyez sur  +  pour quitter.

Pour retourner à l'option de réglage précédente, appuyez sur .

Défaut: [XX]

[SYSTEM]	
[KEY BEEP]	(Non applicable quand la transition 3 voies est sélectionnée.) [ON]: Met en service la tonalité des touches. ; [OFF]: Met hors service la fonction.
[FACTORY RESET]	[YES]: Réinitialise les réglages aux valeurs par défaut (sauf la station mémorisée). ; [NO]: Annulation.
[CLOCK]	
[CLOCK DISPLAY]	[ON]: L'horloge apparaît sur l'affichage même quand l'appareil est hors tension. ; [OFF]: Annulation.
[ENGLISH]	Sélectionnez la langue d'affichage pour le menu et l'information sur le morceau si elle est disponible.
[ESPANOL]	Par défaut, [ENGLISH] est sélectionné.
[FRANCAIS]	

Tuner HD Radio™/Radio

Pour KD-X480BHS, vous pouvez accorder à la fois les émissions conventionnelles et HD Radio.

Recherche d'une station ou d'un canal

- 1 Appuyez répétitivement sur pour sélectionner FM ou AM.
- 2 Pour KD-X480BHS: Maintenez enfoncé pour choisir le monde d'accord.
 - [HD SEEK]: Recherchez uniquement une station HD Radio.
 - [MANUAL SEEK]: Faites une recherche d'émissions ordinaires et HD Radio.
- 3 Appuyez sur / pour rechercher une station ou un canal automatiquement.
(ou)
Maintenez enfoncé / jusqu'à ce que "M" clignote, puis appuyez répétitivement dessus pour rechercher une station ou un canal manuellement

Réglages en mémoire

Pour KD-X480BHS, vous pouvez mémoriser un maximum de 18 stations/canaux pour FM et de 6 stations/canaux pour AM.
Pour KD-X380BTS, vous pouvez mémoriser un maximum de 18 stations pour FM et de 6 stations pour AM.

Mémorisation d'une station ou un canal

Lors de l'écoute d'une station ou d'un canal...

Maintenez enfoncée une des touches numériques (1 à 6).

- (ou)
- 1 Maintenez enfoncé le bouton de volume jusqu'à ce que "PRESET MODE" clignote.
 - 2 Tournez le bouton de volume pour choisir un numéro de préréglage, puis appuyez sur le bouton.
"MEMORY" apparaît une fois que la station ou le canal est mémorisé.

Sélection d'une station ou d'un canal mémorisé

Appuyez sur l'une des touches numériques (1 à 6).

- (ou)
- 1 Appuyez sur .
 - 2 Pour KD-X480BHS: Tournez le bouton de volume pour choisir [PRESET LIST], puis appuyez sur le bouton.
 - 3 Tournez le bouton de volume pour choisir un numéro de préréglage, puis appuyez sur le bouton.

USB/iPod

Source sélectionnable:

- USB/iPod USB ou iPod BT





Démarrez la lecture

La source change automatiquement et la lecture démarre quand vous connectez un périphérique (périphérique USB/ iPod/iPhone) à la prise d'entrée USB.

- Assurez-vous que [USB] est sélectionné pour [IPHONE SETUP] dans le menu [USB] pour écouter l'iPod/iPhone.

Pour	Sur la façade
Recherche rapide vers l'arrière/vers l'avant	Maintenez enfoncée / .
Sélectionnez un fichier	Appuyez sur / .
Sélectionnez un dossier	Appuyez sur / .
Lecture répétée	Appuyez répétitivement sur .
Lecture aléatoire	Appuyez répétitivement sur .

Réglages du menu

- 1 Maintenez enfoncée   pour entrer en réglages du menu.
- 2 Tournez le bouton de volume pour choisir un élément, puis appuyez sur le bouton.
- 3 Répétez l'étape 2 jusqu'à ce que l'élément souhaité soit sélectionné ou activé.
- 4 Appuyez sur   pour quitter.

Pour retourner à l'option de réglage précédente, appuyez sur  / .

- Reportez-vous au MANUEL D'INSTRUCTIONS sur les sites web suivant pour une explication détaillée de chaque élément: <<https://www.jvc.net/cs/car/>>
- La disponibilité de chaque élément varie en fonction du modèle.



Éléments du menu

- [EQ SETTING] : Sélectionne un égaliseur préréglé ou ajuste vos propres réglages du son.
- [AUDIO CONTROL] : Règle vos réglages audio préférés.
- [SOUND EFFECT] : Règle votre effet sonore préféré.
- [DISPLAY] : Règle votre commande préférée pour la fenêtre d'affichage.
- [COLOR] : Règle votre couleur d'éclairage préférée pour les touches.
- [TUNER SETTING] : Réglages pour la source radio.
- [SIRIUS XM] : Réglages pour le tuner Sirius XM.
- [USB] : Règle la source de lecture iPod/iPhone (via la prise d'entrée USB ou via Bluetooth).
- [BT MODE] : Réglages pour l'utilisation d'un périphérique Bluetooth.
- [REMOTE APP] : Réglages pour l'utilisation d'un smartphone pour commander cet appareil.
- [ALEXA SETUP] : Règle votre langue de commande vocale préférée pour Alexa.
- [MIC GAIN]* : Règle la sensibilité d'un microphone.
- [NR LEVEL]* : Ajuste du niveau de réduction de bruit.
- [ECHO CANCEL]* : Ajuste le temps de retard d'annulation de l'écho.
- [SYSTEM] : Réglages pour cet appareil.
- [CLOCK] : Règle l'horloge.
- [ENGLISH] : Sélectionne la langue pour le menu et les informations sur le morceau.
- [ESPAÑOL] : Sélectionne la langue pour le menu et les informations sur le morceau.
- [FRANCAIS] : Sélectionne la langue pour le menu et les informations sur le morceau.
- [DEMO MODE] : Met en ou hors service la démonstration des affichages.

* Utilisable uniquement pendant que vous parlez au téléphone.

Exemples de certains réglages utilisés fréquemment

■ Réglage du niveau de caisson de grave

- 1 Maintenez enfoncée   pour entrer en réglages du menu.



- 2 Tournez le bouton de volume dans le sens des aiguilles d'une montre pour choisir [AUDIO CONTROL], puis appuyez sur le bouton.

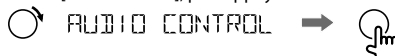

- 3 Tournez le bouton de volume dans le sens des aiguilles d'une montre pour choisir [SUBWOOFER SET], puis appuyez sur le bouton.

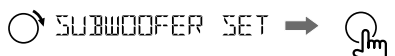

- 4 Tournez le bouton de volume dans le sens des aiguilles d'une montre pour choisir [ON], puis appuyez sur le bouton.

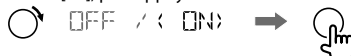

- 5 Tournez le bouton de volume dans le sens des aiguilles d'une montre pour choisir [SUB.W LEVEL], puis appuyez sur le bouton.

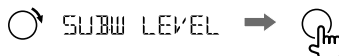



- 6 Appuyez sur le bouton de volume si [PRE-OUT] apparaît sur l'affichage.

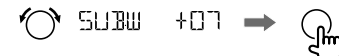

- 7 Tournez le bouton de volume pour ajuster le niveau de caisson de grave, puis appuyez sur le bouton.



Suite à la page suivante...



- 8 Appuyez sur   pour quitter le menu de réglage.

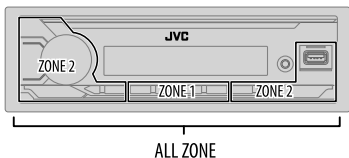

■ Réglage de la couleur d'éclairage

Vous pouvez régler votre couleur d'éclairage préférée pour chaque zone.



- 1 Maintenez enfoncée   pour entrer en réglages du menu.



- 2 Tournez le bouton de volume dans le sens des aiguilles d'une montre pour choisir [COLOR], puis appuyez sur le bouton.



- 3 Appuyez sur le bouton de volume si [PRESET] apparaît sur l'affichage.



- 4 Tournez le bouton de volume pour choisir une zone ([ALL ZONE], [ZONE 1], [ZONE 2]), puis appuyez sur le bouton.





- 5 Tournez le bouton de volume pour choisir une couleur, puis appuyez sur le bouton.



- [COLOR 01] à [COLOR 49]
- [USER]: La couleur que vous avez créée pour [DAY COLOR] ou [NIGHT COLOR] apparaît.
- [COLOR FLOW01] à [COLOR FLOW03]: La couleur change à une vitesse différente.
- [CRYSTAL]/[FLOWER]/[FOREST]/[GRADATION]/[OCEAN]/[RELAX]/[SUNSET]: Le motif de couleur sélectionné apparaît. (Sélectionnable uniquement quand [ALL ZONE] est choisi à l'étape 4.)

- 6 Répétez l'étape 4 et l'étape 5 pour régler la couleur pour les autres zones.

- 7 Appuyez sur   pour quitter.



Autres informations

Pour les opérations de lecture de sources **AUX**, **Radio SiriusXM®** et **AMAZON ALEXA**, reportez-vous au MANUEL D'INSTRUCTIONS sur le site web suivant: <https://www.jvc.net/cs/car/>

- La disponibilité de chaque source varie en fonction du modèle.

Remarque pour les spécifications

Plage de fréquences Bluetooth:

2,402 GHz — 2,480 GHz

Puissance de sortie RF Bluetooth (E.I.R.P.):

+4 dBm (MAX), Classe d'alimentation 2

Impédance d'enceinte:

4 Ω — 8 Ω

Tension de fonctionnement:

Batterie de voiture 12 V CC

Bluetooth®

- En fonction de la version Bluetooth, du système d'exploitation et de la version du micrologiciel de votre téléphone portable, la fonction Bluetooth peut ne pas fonctionner avec cet appareil.
- Assurez-vous d'activer la fonction Bluetooth du périphérique pour réaliser les opérations suivantes.
- La condition du signal varie en fonction de l'environnement.

■ Connectez le microphone

Branchez le microphone fourni sur la prise d'entrée du microphone sur le panneau arrière.

Ajustez l'angle du microphone

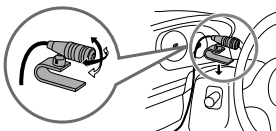

Fixez si nécessaire en utilisant des serre-câbles (non fourni).

■ Faites le pairage et connectez un périphérique Bluetooth pour la première fois

- 1 Appuyez sur **SRC** pour mettre l'appareil sous tension.
- 2 Recherchez et sélectionnez le nom de votre récepteur ("KD-X480BHS"/"KD-X380BTS") sur le périphérique Bluetooth.
- 3 Réalisez (A) ou (B) en fonction de ce qui apparaît sur l'affichage. Pour certains périphériques Bluetooth, la séquence de pairage peut varier en fonction des étapes décrites ci-dessous.

(A) "[Nom du périphérique]" → "XXXXXX" → "VOL – YES" → "BACK – NO"
"XXXXXX" est un code à 6 chiffres généré aléatoirement pendant chaque pairage.

- 1 Assurez-vous que les codes qui apparaissent sur l'appareil et le périphérique Bluetooth sont les mêmes.
- 2 Appuyez sur le bouton de volume pour valider le code.
- 3 Utilisez le périphérique Bluetooth pour valider le code.

(B) "[Nom du périphérique]" → "VOL – YES" → "BACK – NO"

- 1 Appuyez sur le bouton de volume pour démarrer le pairage.
- 2 Si "PAIRING" → "PIN 0000" défile sur l'affichage, entrez le code PIN "0000" sur le périphérique Bluetooth.
 - Si seul "PAIRING" apparaît, utilisez le périphérique Bluetooth pour confirmer le pairage.

"PAIRING COMPLETED" apparaît quand le pairage est terminé et **BT** s'allume quand la connexion Bluetooth est établie.

■ Répondre à un appel

Appuyez sur **CALL** ou sur le bouton de volume.

- Pour ajuster le volume du téléphone entre [00] et [35], tournez le bouton de volume.
- Pour terminer un appel, maintenez enfoncé **CALL** ou le bouton de volume.

■ Lecteur audio via Bluetooth

- 1 Appuyez répétitivement sur **SRC** pour sélectionner BT AUDIO.
- 2 Commandez le lecteur audio via Bluetooth pour démarrer la lecture.

Pour	Sur la façade
Lecture/pause	Appuyez sur le bouton de volume.
Choisissez un groupe ou un dossier	Appuyez sur 2▲ / 1▼.
Saut vers l'arrière/saut vers l'avant	Appuyez sur ◀◀ / ▶▶.
Recherche rapide vers l'arrière/vers l'avant	Maintenez enfoncée ◀◀ / ▶▶.
Lecture répétée	Appuyez répétitivement sur 4↻.
Lecture aléatoire	Appuyez répétitivement sur 3⌂.

Instalación/Conexión

Esta sección es para los instaladores profesionales.
Para fines de seguridad, deje que un profesional realice el cableado y el montaje. Consulte con un distribuidor de productos de audio para automóviles.

▲ ADVERTENCIA

- La unidad puede utilizarse solamente con una fuente de alimentación de 12 V CC con negativo a masa.
- Desconecte el terminal negativo de la batería antes de realizar el cableado y el montaje.
- Para evitar un cortocircuito, no conecte el cable de la batería (amarillo) ni el cable de encendido (rojo) al chasis del vehículo o cable de conexión a masa (negro).
- Para evitar cortocircuitos:
 - Utilice una cinta de vinilo para aislar los cables no conectados.
 - Asegúrese de volver a conectar a masa esta unidad al chasis del automóvil después de la instalación.
 - Para proteger los cables, asegúrelos con abrazaderas de cables y con una cinta de vinilo, enrolle los cables que entran en contacto con partes metálicas.

▲ PRECAUCIÓN

- Instale esta unidad en la consola de su vehículo. No toque las partes metálicas de la unidad durante o un poco después del uso de la unidad. Las partes metálicas, tales como el disipador de calor o la carcasa, pueden estar muy calientes.
- No conecte los cables \ominus de los altavoces al chasis del vehículo, al cable de conexión a masa (negro) o en paralelo.
- Conecte altavoces con una potencia máxima de más de 50 W. Si la potencia máxima de los altavoces es inferior a 50 W, cambie el ajuste [AMP GAIN] para evitar daños en los mismos.
- Monte la unidad a un ángulo de menos de 30°.
- Si el mazo de conductores de su vehículo no dispone de terminal de encendido, conecte el cable de encendido (rojo) al terminal de la caja de fusibles del vehículo, el cual suministrará una alimentación de 12 V CC y podrá conectarse y desconectarse mediante la llave de encendido.
- Mantenga todos los cables alejados de las partes metálicas disipadoras de calor.
- Después de instalar la unidad, compruebe que las lámparas de freno, las luces intermitentes, el limpiaparabrisas, etc. funcionen satisfactoriamente.
- Si se funde el fusible, en primer lugar asegúrese de que los cables no estén en contacto con el chasis del vehículo y, a continuación, reemplace el fusible usado por otro del mismo régimen.

■ Procedimiento básico

- 1 Quite la llave del interruptor de encendido; después, desconecte el terminal \ominus de la batería del automóvil.
- 2 Conecte los cables correctamente. Consulte "Conexión del cableado" en la página 3.
- 3 Instale la unidad en su automóvil. Consulte lo siguiente "Instalación de la unidad (montaje en el tablero)".
- 4 Conecte el terminal \ominus de la batería del automóvil.
- 5 Pulse \odot SRC para encender la unidad.
- 6 Extraiga la placa frontal y reinicialice la unidad en menos de 5 segundos. Consulte "Cómo reinicializar" en la página 4.

Instalación de la unidad (montaje en el tablero)

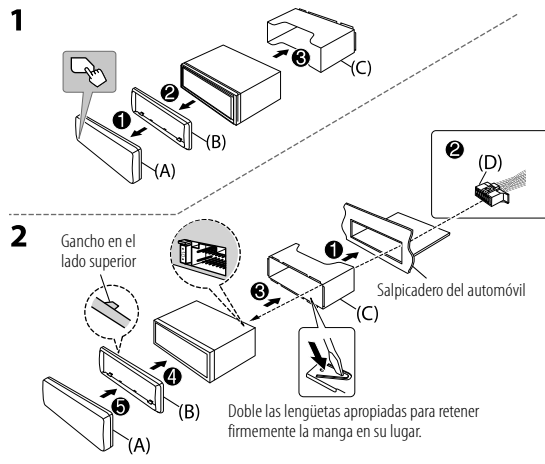

Instalación de la unidad (sin manguito de montaje)

- 1 Retire de la unidad, el manguito de montaje y la placa embellecedora.
- 2 Alinee los orificios de la unidad (en ambos lados) con la ménsula de montaje del vehículo y asegure la unidad con los tornillos (disponibles en el mercado).

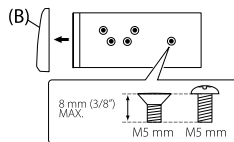

⚠ Utilice solo los tornillos especificados. El uso de tornillos incorrectos puede dañar la unidad.

Desmontaje de la unidad

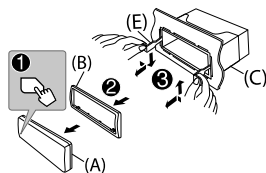

Lista de piezas (suministradas)

- (A) Placa frontal (x1)
 (B) Placa embellecedora (x1)
 (C) Manguito de montaje (x1)
 (D) Mazo de conductores (x1)
 (E) Herramienta de extracción (x2)

Conexión del cableado

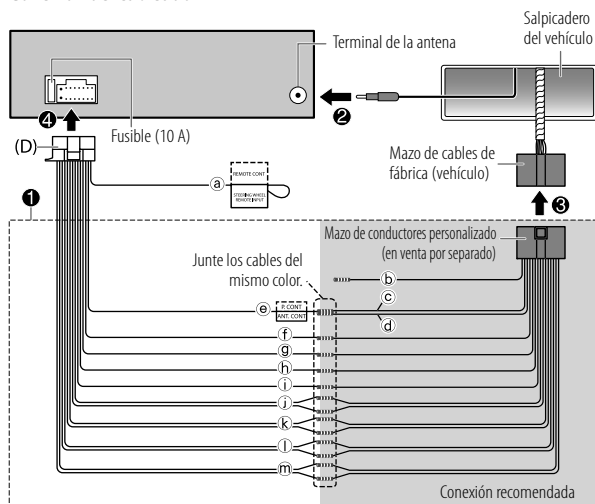

- a** Luz azul/amarilla: Al adaptador del mando a distancia del volante de la dirección
b Marrón (sin utilizar)
c Azul: A la antena motriz
d Azul/blanco: Al amplificador
e Azul/blanco: Remoto (12 V $\overline{\text{---}}$ 350 mA)
f Naranja/blanco: Iluminación
g Amarillo: Batería de 12 V
h Rojo: Encendido de 12 V

- i** Negro: Tierra
j Gris \oplus , Gris/negro \ominus : Altavoz delantero (derecho)
k Blanco \oplus , Blanco/negro \ominus : Altavoz delantero (izquierdo)
l Púrpura \oplus , Púrpura/negro \ominus : Altavoz trasero (derecho)
m Verde \oplus , Verde/negro \ominus : Altavoz trasero (izquierdo)

Antes del uso

IMPORTANTE

- Antes de utilizar este producto y para asegurar su uso correcto, lea esta guía por completo. En especial, lea y observe las Advertencias y Precauciones incluidas en esta guía.
- Guarde la guía en un lugar seguro y accesible para futuras consultas.

▲ ADVERTENCIA

No utilice ninguna función que pueda desviar su atención mientras está conduciendo el vehículo.

▲ PRECAUCIÓN

Ajuste del volumen:

- Ajuste el volumen a un nivel que le permita oír los ruidos del exterior para impedir accidentes.
- Antes de reproducir fuentes digitales, baje el volumen para evitar que el repentino aumento del nivel de salida cause daños a los altavoces.

General:

- Evite el uso de dispositivos externos cuando puedan afectar la seguridad de conducción.
- Asegúrese de tener una copia de respaldo de todos los datos importantes. No aceptamos responsabilidad alguna por la pérdida de los datos grabados.
- Para evitar cortocircuitos, nunca coloque ni deje objetos metálicos (por ejemplo, monedas o herramientas metálicas) dentro de la unidad.
- Dependiendo del tipo de vehículo, la antena se extiende automáticamente cuando se enciende la unidad con el cable de control de antena conectado. Apague la unidad cuando estacione en un lugar con techo bajo.

Puntos básicos

Placa frontal

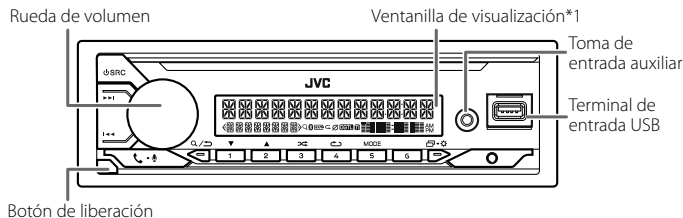

*1 Solo para fines ilustrativos.

Para	En la placa frontal	
Fijar 	Desmontar 	Cómo reinicializar <p>Reinicialice la unidad en menos de 5 segundos después de haber extraído la placa frontal.</p>
Encender la unidad	Pulse SRC. • Pulse y mantenga pulsado para apagar la unidad.	
Ajustar el volumen	Gire la rueda de volumen.	
Seleccionar una fuente	Pulse SRC repetidamente.	
Cambiar la información en pantalla*2	Pulse repetidamente.	

*2 Una de las informaciones en pantalla admite el Efecto de sincronización de música. El color de iluminación o el nivel de brillo de los botones cambia y se sincroniza con el nivel de música.

Procedimientos iniciales

1 Confirmar el tipo de transición y cancelar la demostración

Cuando enciende la unidad por primera vez (o [FACTORY RESET] está ajustado a [YES]), en la pantalla se muestra: "2-WAY X'OVER" o "3-WAY X'OVER" → "PRESS" → "VOLUME KNOB" → "TO CONFIRM".

- 1 Pulse la rueda de volumen para confirmar el tipo de transición actual.
A continuación, en la pantalla se muestra: "CANCEL DEMO" → "PRESS" → "VOLUME KNOB"
- 2 Pulse la rueda de volumen.
Se selecciona [YES] para la configuración inicial.
- 3 Pulse de nuevo la rueda de volumen.
Aparece "DEMO OFF".



2 Ajuste del reloj y la fecha

- 1 Pulse y mantenga pulsado  + .
- 2 Gire la rueda de volumen para seleccionar [CLOCK] y, a continuación, pulse la rueda.

Para ajustar el reloj





- 3 Gire la rueda de volumen para seleccionar [CLOCK ADJUST] y, a continuación, pulse la rueda.
- 4 Gire la rueda de volumen para realizar los ajustes y, a continuación, pulse la rueda.
Ajuste la hora en el orden de "Hora" → "Minutos".
- 5 Gire la rueda de volumen para seleccionar [CLOCK FORMAT] y, a continuación, pulse la rueda.
- 6 Gire la rueda de volumen para seleccionar [12H] o [24H] y, a continuación, pulse la rueda.

Para ajustar la fecha

- 7 Gire la rueda de volumen para seleccionar [DATE SET] y, a continuación, pulse la rueda.
- 8 Gire la rueda de volumen para realizar los ajustes y, a continuación, pulse la rueda.
Ajuste la fecha en el orden de "Día" → "Mes" → "Año".
- 9 Pulse  +  para salir.

Para volver al elemento de ajuste anterior, pulse  / .

3 Realice los ajustes básicos

- 1 Pulse y mantenga pulsado  + .
- 2 Gire la rueda de volumen para seleccionar un elemento (consulte la siguiente tabla) y, a continuación, pulse la rueda.
- 3 Repita el paso 2 hasta que se seleccione o active el elemento deseado.
- 4 Pulse  +  para salir.

Para volver al elemento de ajuste anterior, pulse  / .

Predeterminado: [XX]

[SYSTEM]	
[KEY BEEP]	(No aplicable si se ha seleccionado crossover de 3 vías.) [ON]: Activa el tono de pulsación de teclas. ; [OFF]: Se desactiva.
[FACTORY RESET]	[YES]: Se restablecen los ajustes predeterminados (excepto la emisora memorizada). ; [NO]: Se cancela.
[CLOCK]	
[CLOCK DISPLAY]	[ON]: La hora del reloj siempre se visualiza en la pantalla cuando la unidad está apagada. ; [OFF]: Se cancela.
[ENGLISH]	Seleccione el idioma de visualización para el menú y la información de la música, si corresponde.
[ESPANOL]	Por defecto, se selecciona [ENGLISH].
[FRANCAIS]	

Sintonizador HD Radio™/Radio

Para KD-X480BHS, puede sintonizar tanto transmisiones convencionales y emisiones de HD Radio.

■ Busca una emisora o un canal de radio

- 1 Pulse SRC repetidamente para seleccionar FM o AM.
- 2 Para KD-X480BHS: Pulse y mantenga pulsado para seleccionar el modo de sintonización.
 - [HD SEEK]: Busca sólo emisión de HD Radio.
 - [MANUAL SEEK]: Busca tanto emisiones convencionales como HD Radio.
- 3 Pulse / para la búsqueda automática de una emisora o un canal.
(o)
Pulse y mantenga pulsado / hasta que parpadee "M" y, a continuación, pulse repetidamente para la búsqueda manual de una emisora o un canal.

■ Ajustes en la memoria

Para KD-X480BHS, puede almacenar hasta 18 emisoras/canales de FM y 6 emisoras/canales de AM en la memoria.

Para KD-X380BTS, puede almacenar hasta 18 emisoras de FM y 6 emisoras de AM en la memoria.

Guarde una emisora o un canal

Mientras escucha una emisora o un canal...

Pulse y mantenga pulsado uno de los botones numéricos (1 a 6).
(o)

- 1 Pulse y mantenga pulsada la rueda de volumen hasta que "PRESET MODE" parpadee.
- 2 Gire la rueda de volumen para seleccionar un número de preajuste y, a continuación, pulse la rueda.
Aparece "MEMORY" una vez que la emisora o el canal esté almacenado.

Seleccione una emisora o canal guardado

Pulse uno de los botones numéricos (1 a 6).
(o)

- 1 Pulse .
- 2 Para KD-X480BHS: Gire la rueda de volumen para seleccionar [PRESET LIST] y, a continuación, pulse la rueda.
- 3 Gire la rueda de volumen para seleccionar un número de preajuste y, a continuación, pulse la rueda.

USB/iPod

Fuente seleccionable:

- USB/iPod USB o iPod BT



■ Inicie la reproducción

La fuente cambia automáticamente y la reproducción se inicia al conectar un dispositivo (dispositivo USB/ iPod/iPhone) al terminal de entrada USB.

- Asegúrese de que [USB] esté seleccionado para [IPHONE SETUP] en el menú [USB] para escuchar el iPod/iPhone.

Para	En la placa frontal
Retroceder/avanzar rápidamente	Pulse y mantenga pulsado / .
Seleccionar un archivo	Pulse / .
Seleccionar una carpeta	Pulse / .
Repetir reproducción	Pulse repetidamente.
Reproducción aleatoria	Pulse repetidamente.

Ajustes del menú

- 1 Pulse y mantenga pulsado  para acceder a los ajustes del menú.
- 2 Gire la rueda de volumen para seleccionar un elemento y, a continuación, pulse la rueda.
- 3 Repita el paso 2 hasta que se seleccione o active el elemento deseado.
- 4 Pulse  para salir.

Para volver al elemento de ajuste anterior, pulse .

- Para obtener más detalles sobre cada una de las opciones, consulte el MANUAL DE INSTRUCCIONES en el siguiente sitio web: [<https://www.jvc.net/cs/car/>](https://www.jvc.net/cs/car/)
- La disponibilidad de cada opción varía según el modelo.

Elementos del menú

- [EQ SETTING] : Selecciona un ecualizador preajustado o realiza sus propios ajustes de sonido.
- [AUDIO CONTROL] : Establece sus ajustes de audio preferidos.
- [SOUND EFFECT] : Establece el efecto de sonido preferido.
- [DISPLAY] : Establece su control preferido para la ventanilla de visualización.
- [COLOR] : Establece el color de iluminación preferido para los botones.
- [TUNER SETTING] : Configuración de la fuente de radio.
- [SIRIUS XM] : Configuración del sintonizador Sirius XM.
- [USB] : Ajusta la fuente de reproducción de iPod/iPhone (a través del terminal de entrada USB o mediante Bluetooth).
- [BT MODE] : Configuración utilizando un dispositivo Bluetooth.
- [REMOTE APP] : Configuración utilizando un smartphone para controlar esta unidad.
- [ALEXA SETUP] : Establece el idioma de control por voz preferido para Alexa.
- [MIC GAIN]* : Establece la sensibilidad del micrófono.
- [NR LEVEL]* : Ajusta el nivel de reducción de ruido.
- [ECHO CANCEL]* : Ajusta el tiempo de retardo de cancelación de eco.
- [SYSTEM] : Configuración de esta unidad.
- [CLOCK] : Ajusta el reloj.
- [ENGLISH] : Selecciona el idioma para el menú y la información de música.
- [ESPANOL] : Selecciona el idioma para el menú y la información de música.
- [FRANCAIS] : Selecciona el idioma para el menú y la información de música.
- [DEMO MODE] : Activa o desactiva la demostración en pantalla.

* Aplicable solamente mientras se habla por teléfono.

Ejemplos de algunos ajustes de uso frecuente

Ajuste del nivel de subwoofer

- 1 Pulse y mantenga pulsado  para acceder a los ajustes del menú.



- 2 Gire la rueda de volumen en sentido horario para seleccionar [AUDIO CONTROL] y, a continuación, pulse la rueda.



- 3 Gire la rueda de volumen en sentido horario para seleccionar [SUBWOOFER SET] y, a continuación, pulse la rueda.

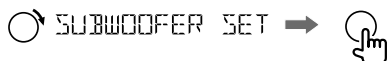

- 4 Gire la rueda de volumen en sentido horario para seleccionar [ON] y, a continuación, pulse la rueda.

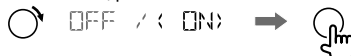

- 5 Gire la rueda de volumen en sentido horario para seleccionar [SUB.W LEVEL] y, a continuación, pulse la rueda.

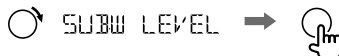

- 6 Pulse la rueda de volumen si [PRE-OUT] se muestra en la pantalla.



- 7 Gire la rueda de volumen para ajustar el nivel de subwoofer y, a continuación, pulse la rueda.

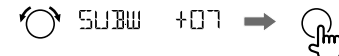

Continúa en la página siguiente...

- 8 Pulse  para salir del menú de ajuste.



Ajuste del color de iluminación

Puede ajustar el color de iluminación preferido para cada zona.

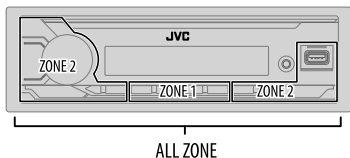

- 1 Pulse y mantenga pulsado  para acceder a los ajustes del menú.



- 2 Gire la rueda de volumen en sentido horario para seleccionar [COLOR] y, a continuación, pulse la rueda.



- 3 Pulse la rueda de volumen si [PRESET] se muestra en la pantalla.



- 4 Gire la rueda de volumen para elegir una zona ([ALL ZONE], [ZONE 1], [ZONE 2]) y, a continuación, pulse la rueda.



- 5 Gire la rueda de volumen para seleccionar un color y, a continuación, pulse la rueda.



- [COLOR 01] a [COLOR 49]
- [USER]: Se muestra el color que ha creado para [DAY COLOR] o [NIGHT COLOR].
- [COLOR FLOW01] a [COLOR FLOW03]: El color cambia según las velocidades.
- [CRYSTAL]/[FLOWER]/[FOREST]/[GRADATION]/[OCEAN]/[RELAX]/[SUNSET]: Se muestra el patrón del color seleccionado. (Puede seleccionarse sólo si se selecciona [ALL ZONE] en el paso 4.)

- 6 Repita los pasos 4 y 5 para definir el color para las otras zonas.

- 7 Pulse  para salir.



Otras informaciones

Con respecto a las operaciones de reproducción de las fuentes **AUX**, **Radio SiriusXM®** y **AMAZON ALEXA**, consulte el MANUAL DE INSTRUCCIONES en el siguiente sitio web: <<https://www.jvc.net/cs/car/>>

- La disponibilidad de cada fuente varía según el modelo.

Nota sobre las especificaciones

Rango de frecuencia Bluetooth:

2,402 GHz — 2,480 GHz

Potencia de salida de RF Bluetooth (E.I.R.P.):

+4 dBm (MAX), potencia clase 2

Impedancia del altavoz:

4 Ω — 8 Ω

Voltaje de trabajo:

Batería de 12 V CC para vehículos

Bluetooth®

- Las funciones Bluetooth podrían no funcionar con esta unidad, dependiendo de la versión de Bluetooth, del sistema operativo y de la versión de firmware de su teléfono móvil.
- Para realizar las siguientes operaciones, asegúrese de activar la función Bluetooth del dispositivo.
- Las condiciones de la señal varían dependiendo del entorno.

Conecte el micrófono

Conecte el micrófono suministrado a la toma de entrada de micrófono en el panel trasero.

Ajuste el ángulo del micrófono

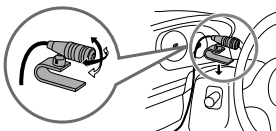

Asegúrelo mediante abrazaderas para cable (no suministradas) si fuera necesario.

Emparejar y conectar por primera vez un dispositivo Bluetooth

- 1 Pulse **⏻** SRC para encender la unidad.
- 2 Busque y seleccione el nombre de su receptor ("KD-X480BHS"/"KD-X380BTS") en el dispositivo Bluetooth.
- 3 Realice (A) o (B) dependiendo de los datos mostrados en la pantalla.
En el caso de algunos dispositivos Bluetooth, la secuencia de emparejamiento puede diferir de lo descrito en los siguientes pasos.

(A) "[Nombre del dispositivo]" → "XXXXXX" → "VOL – YES" → "BACK – NO"

"XXXXXX" es una clave de 6 dígitos que se genera aleatoriamente durante cada emparejamiento.

- 1 Asegúrese de que las claves que aparecen en la unidad coincidan con las que aparecen en el dispositivo Bluetooth.
- 2 Pulse la rueda de volumen para confirmar la clave.
- 3 Opere el dispositivo Bluetooth para confirmar la clave.

(B) "[Nombre del dispositivo]" → "VOL – YES" → "BACK – NO"

- 1 Pulse la rueda de volumen para iniciar el emparejamiento.
- 2
 - Si "PAIRING" → "PIN 0000" aparece en la pantalla, ingrese el código PIN "0000" en el dispositivo Bluetooth.
 - Si solo aparece "PAIRING", opere el dispositivo Bluetooth para confirmar el emparejamiento.

El mensaje "PAIRING COMPLETED" aparece cuando ha finalizado el emparejamiento; **Ⓜ** se iluminará cuando se establezca la conexión Bluetooth.

Contestar una llamada

Pulse **📞**, **⏻** o la rueda de volumen.

- Para ajustar el volumen del teléfono de [00] a [35], gire la rueda de volumen.
- Para finalizar una llamada, pulse y mantenga pulsado **📞**, **⏻** o la rueda de volumen.

Reproductor de audio a través de Bluetooth

- 1 Pulse **⏻** SRC repetidamente para seleccionar BT AUDIO.
- 2 Para iniciar la reproducción, utilice el reproductor de audio a través de Bluetooth.

Para	En la placa frontal
Reproducción/pausa	Pulse la rueda de volumen.
Seleccione un grupo o carpeta	Pulse 2▲ / 1▼.
Omisión hacia atrás/omisión hacia delante	Pulse ◀◀ / ▶▶.
Retroceder/avanzar rápidamente	Pulse y mantenga pulsado ◀◀ / ▶▶.
Repetir reproducción	Pulse 4↻ repetidamente.
Reproducción aleatoria	Pulse 3🔀 repetidamente.

- Windows Media is a registered trademark or trademark of Microsoft Corporation in the United States and/or other countries. This product is protected by certain intellectual property rights of Microsoft. Use or distribution of such technology outside of this product is prohibited without a license from Microsoft.
- HD Radio Technology manufactured under license from iBiquity Digital Corporation. U.S. and Foreign Patents. For patents see <http://dts.com/patents>. HD Radio™ and the HD, HD Radio, and “ARC” logos are registered trademarks or trademarks of iBiquity Digital Corporation in the United States and/or other countries.
- Use of the Made for Apple badge means that an accessory has been designed to connect specifically to the Apple product(s) identified in the badge and has been certified by the developer to meet Apple performance standards. Apple is not responsible for the operation of this device or its compliance with safety and regulatory standards. Please note that the use of this accessory with an Apple product may affect wireless performance.
- Apple, iPhone, iPod, and iPod touch are trademarks of Apple Inc., registered in the U.S. and other countries.
- IOS is a trademark or registered trademark of Cisco in the U.S. and other countries and is used under license.
- SiriusXM and all related marks and logos are trademarks of Sirius XM Radio, Inc. All rights reserved.
- Android is a trademark of Google LLC.
- The Bluetooth® word mark and logos are registered trademarks owned by Bluetooth SIG, Inc. and any use of such marks by JVCKENWOOD Corporation is under license. Other trademarks and trade names are those of their respective owners.
- Amazon, Alexa and all related marks are trademarks of Amazon.com, Inc. or its affiliates.
- Alexa is not available in all languages and countries. Alexa features and functionality may vary by location.

