



# KW-M180BT

MONITOR WITH RECEIVER

## INSTRUCTION MANUAL

JVCKENWOOD Corporation

- Updated information (the latest Instruction Manual, etc.) is available from <<https://www.jvc.net/cs/car/>>.

### Model name indication position

See "Removing the trim plate" (P.19)

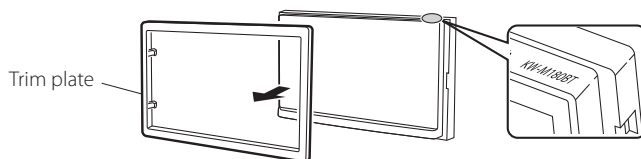

# Contents

Before use .....	2
How to read this manual .....	2
Precautions .....	2
Getting Started .....	3
Clock settings .....	3
Basics .....	4
Functions of the Buttons on the Front Panel .....	4
Common operations .....	4
HOME screen descriptions .....	5
Source control screen .....	5
Tuner .....	6
Tuner Basic Operation .....	6
Presetting stations .....	6
Tuner Setup .....	6
USB .....	7
Preparation .....	7
Playback operations .....	7
iPhone .....	8
Preparation .....	8
Playback operations .....	8
Mirroring .....	9
Preparation .....	9
Mirroring operations .....	9
External Components .....	10
Using external audio/video players .....	10
Rear view camera .....	10
Learning function of steering remote .....	11
Reverse with ATT .....	11
Bluetooth .....	12
Register your smartphone to the unit .....	12
Bluetooth Setup .....	12
Receive a phone call .....	13
Make a phone call .....	13
Playing Bluetooth Audio Device .....	14
Controlling Audio .....	15
Controlling General Audio .....	15
Equalizer Control .....	15
Speaker / X'over setup .....	16
Listening Position DTA .....	16
Sound Effect .....	16
Remote control .....	17
Battery Installation .....	17
Functions of the Remote control Buttons .....	17
Installation .....	18
Before Installation .....	18
Installing the unit .....	19
About this Unit .....	22
More information .....	22
Troubleshooting .....	23
Specifications .....	24
Copyrights .....	25

# Before use

## How to read this manual

- The panels shown in this guide are examples used to provide clear explanations of the operations. For this reason, they may be different from the actual panels.
- In operation procedures, bracket shape indicates the key or button you should control.  
< >: indicates the name of panel buttons.  
[ ]: indicates the name of touch keys

 This symbol on the product means there are important operating and maintenance instructions in this manual. Be sure to carefully read instructions in this manual.

## Precautions

### WARNING

#### To prevent injury or fire, take the following precautions:

- To prevent a short circuit, never put or leave any metallic objects (such as coins or metal tools) inside the unit.
- Do not watch or fix your eyes on the unit's display when you are driving for any extended period.
- If you experience problems during installation, consult your JVC dealer.

#### Precautions on using this unit

- When you purchase optional accessories, check with your JVC dealer to make sure that they work with your model and in your area.
- You can select a language to display menus, audio file tags, etc. See **Getting Started (P.3)**
- The Radio Data System or Radio Broadcast Data System feature won't work where the service is not supported by any broadcasting station.

#### Protecting the monitor

- To protect the monitor from damage, do not operate the monitor using a ballpoint pen or similar tool with the sharp tip.

#### Cleaning the Unit

If the front panel of this unit is stained, wipe it with a dry soft cloth such as a silicon cloth. If the front panel is stained badly, wipe the stain off with a cloth moistened with neutral cleaner, then wipe it again with a clean soft dry cloth.

### CAUTION

- Applying spray cleaner directly to the unit may affect its mechanical parts. Wiping the front panel with a hard cloth or using a volatile liquid such as thinner or alcohol may scratch the surface or erase screened print.

#### How to reset your unit

If the unit or the connected unit fails to operate properly, reset the unit.

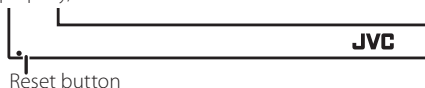

# Getting Started

## 1 Turn the ignition key of your car to ACC.

The unit is turned on, please read the warning and press "Agree" to enter the screen.



## 2 Press the < Home > button.

## 3 Touch [Settings].

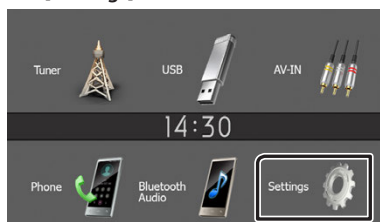

## 4 Touch the corresponding key and set the value.

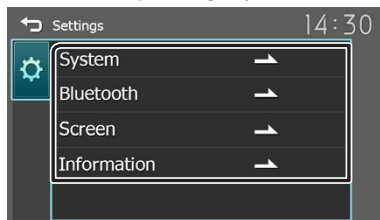

### [System]

#### [Beep Tone]

Activates or deactivates the key-touch tone.  
"ON" (Default), "OFF"

#### [Language]

Select the language used for the control screen and setting items. Default is "English".

#### [Time/Date]

Adjust the clock time. (P.3)

#### [Clock Mode]

Select the time display format.  
[12hr] (Default) / [24hr]

#### [Steering Remote]

Sets the desired function in the steering remote controller. See **Learning function of steering remote (P.11)**

#### [Parking Guidelines]

You can display parking guidelines to enable easier parking when you shift the gear to the reverse (R) position. Default is "ON".

### [Guidelines SETUP]

If you select [ON] for [Parking Guidelines], you can adjust the parking guidelines. See **To adjust the parking guidelines (P.11)**

### [Reverse with ATT (-20dB)]

When the gear is shifted to the reverse (R) position, the volume of the device is adjusted. Default is "ON". See **To adjust the Reverse with ATT (P.11)**

### [System Reset]

Touch [System Reset] and then touch [YES] to set all the settings to the initial default settings.

### [Bluetooth]

Displays the Bluetooth Settings screen. (P.12)

### [Screen]

#### [Dimmer]

Select the dimmer mode.  
"High" (Default) / "Mid" / "Low"

#### [Demo]

Select the demonstration mode. Default is "OFF".

### [Information]

Displays the software version and model number of this unit

## 5 Touch [Clock].

### Clock settings

#### ■ Synchronizing the clock time with FM RDS

Activate [RDS Clock Sync].  
See **Tuner Setup (P.6)**.

#### ■ Adjusting the clock manually

##### 🔑 NOTE

- Deactivate [RDS Clock Sync] before adjusting the clock.

### 1 Press the < Home > button.

### 2 Touch [Settings].

### 3 Touch [System].

### 4 Touch [Time/Date].

Clock screen appears.

### 5 Touch [▲] or [▼] to set the clock time.

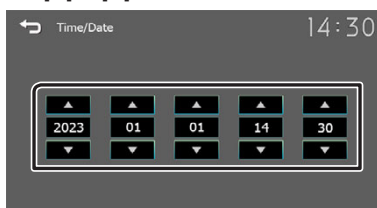

### 6 Touch [Clock].

# Basics

## Functions of the Buttons on the Front Panel

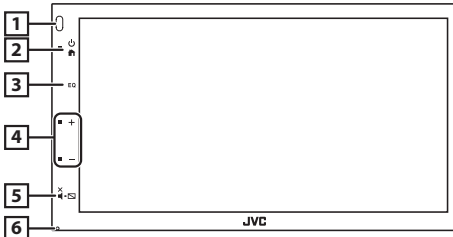

### 1 Remote Sensor

- Receives the remote control signal.

### 2 (HOME)

- Displays the HOME screen. **(P.5)**
- Press and hold turns the power off.
- When the power off, turns the power on.

### 3 EQ

- Displays the Audio screen.\* **(P.15)**
- \* The Audio screen is not displayed during SETUP screen or on the list screen etc.

### 4 +, - (Volume)

- Adjusts volume. The volume will go up until 15 when you keep pressing [+].

### 5 (MUTE, Display off)

- Mutes/restores the sound.
- Press and hold turns the screen off.
- When the screen is off, touch the display to turn on the screen.

### 6 Reset

- If the unit or the connected unit fails to operate properly, the unit returns to factory settings when this button is pressed.

## Common operations

### Turning on the power

- 1 Press the  button.





### Turning off the power

- 1 Press and hold the  button.



### Adjusting the volume

- 1 Press the  or  button.

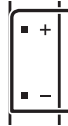

### NOTE

- The volume will go up until 15 when you keep pressing [+].

### Mutes the sound

- 1 Press the  button.



- To restore the sound, touch the button again, or adjust the volume.

### Turn off the screen

- 1 Press and hold the  button.



- To turn on the screen, touch the display.

## Basics



### HOME screen descriptions

1 Press the <img alt="Home button icon" data-bbox="175 105 205 125"/> button.





HOME screen appears.



- 1 Clock display  
Touch to displays the Clock screen.
- 2 Switches to the Tuner broadcast. **(P.6)**
- 3 **[USB]**   
Plays files on a USB device. **(P.7)**  
**[iPhone]**   
Plays an iPhone. **(P.8)**
  - When iPhone is connected.**[Mirroring]**   
Displays the Mirroring screen. **(P.9)**
  - When android device with "Mirroring OB for JVC" application installed is connected.
- 4 Switches to an external component connected to the AV-IN input terminal. **(P.10)**
- 5 Displays the Hands Free screen. **(P.11)**
- 6 Plays a Bluetooth audio player. **(P.14)**
- 7 Displays the SETUP screen. **(P.3)**

### Source control screen



- 1  : Returns to previous screen.  
 : Displays the Audio screen. **(P.15)**

# Tuner

## Tuner Basic Operation

1 Press the <img alt="Home button icon" data-bbox="175 105 195 120"/> button.

2 Touch [Tuner].

 **Source control screen**

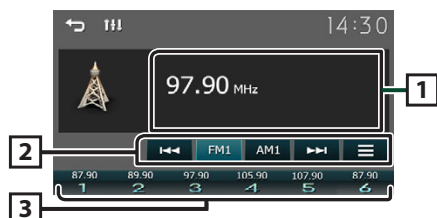

1 Displays the information of the current station:  
PS name, Frequency, PTY Genre, Indicator Items

2 **[FM]** : Switches the FM band.

"FM1", "FM2", "FM3"

**[AM]** : Switches the AM band.

"AM1", "AM2"

**[<img alt="Left arrow" data-bbox="95 415 115 430"/> <img alt="Right arrow" data-bbox="125 415 145 430"/>]** : Tunes in a station with good reception automatically.

Touch and hold to switch to the next frequency manually.

**[<img alt="Menu icon" data-bbox="125 475 145 490"/>]** : Displays the Tuner Setup screen. **(P.6)**

3 Recalls the memorized station.

When touched for 2 seconds, stores the current receiving station in memory.

## Presetting stations

 **Auto memory**

You can preset 6 stations for the current band (FM1/FM2/FM3/AM1/AM2).

1 Touch **[FM]** or **[AM]** to select the band.

2 Touch [].

3 Touch **[Auto Store]**.

The local stations with the strongest signals are found and stored automatically.

 **Manual memory**

You can store the current receiving station in memory.

1 Tune in to a station you want to preset.

2 Touch and hold **[#]** (#:1-6) in which you want to store the station.

 **Recalling the preset station**

1 Touch **[#]** (#:1-6).

## Tuner Setup

1 Touch [].

2 Set each item as follows.

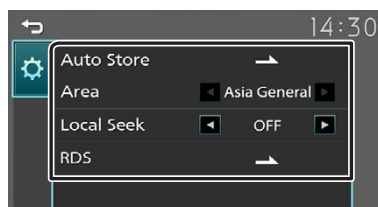

**[Auto Store]**

Automatically searches and stores the 6 stations with the strongest signals for the selected band. "Auto Store" appears.

**[Area]**

"Asia General": AM/FM intervals: 9 kHz/50 kHz.

**[Local Seek]**

Tunes in only to the stations with sufficient signal strength. (**LOC** indicator lights up.)

"ON", "OFF" (Default)

**[RDS]\*1**

Displays the RDS Settings screen.

**[AF]**

When station reception is poor, automatically switches to the station that is broadcasting the same program over the same Radio Data System network.

"ON", "OFF" (Default)

**[TA]**

Switches to the traffic information automatically when the traffic bulletin starts. (**TI** indicator lights up.)

"ON", "OFF" (Default)

**[RDS Clock Sync]**

Synchronizing the Radio Data System station time data and this unit's clock.

"ON" (Default), "OFF"

**[PTY]**

Select a program type.

**[PTY Seek]**

Searches for a program by program type.

\*1 FM only

3 Touch [].

# USB

## Preparation

### ■ Connecting a USB device

- 1 Remove the cap of the USB terminal.
- 2 Connect the USB device with the USB cable.

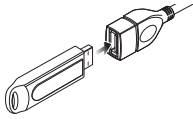

The unit reads the device and playback starts.

### ■ To disconnect the USB device:

- 1 Press the <img alt="Home button icon" data-bbox="175 282 205 300"/> button.
- 2 Touch a source other than [USB].
- 3 Detach the USB device.

### ■ Usable USB device

This unit can play MPEG1/ MPEG2/ MPEG4/ H.264/ MKV/ MP3/WMA/ AAC/ WAV/ FLAC/ OGG files stored in a USB mass storage class device. (P.22)

## Playback operations



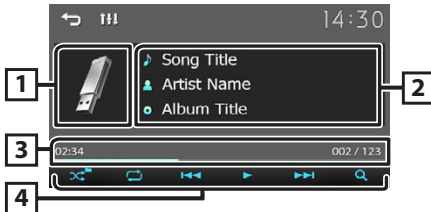







### ■ Control the music you are listening to on the source control screen.



1 The jacket of the currently playing file is displayed.

2 Displays the information of the current file.





3 Playing time/File number  
**Play time bar** : For confirmation of current playing position.

- 4  : Selects Random playback mode.  
 : Randomly plays all files in the current folder.
-  (Default): Normal playback.
-  : Selects Repeat playback mode.
-  (Default): Repeats all files in the USB device.
-  : Repeats the current file.
-  : Repeats all files in the current folder.
-  : Plays or pauses.
-  : Searches the previous/next content.
- Touch and hold to fast forward or fast backward.
-  : Searches file. (P.7)

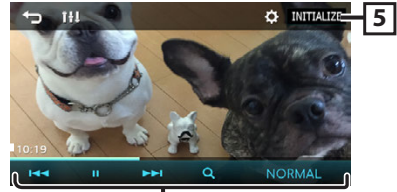

### ■ For Video playback

- 1 When the operation buttons are not displayed on the screen, touch the display.





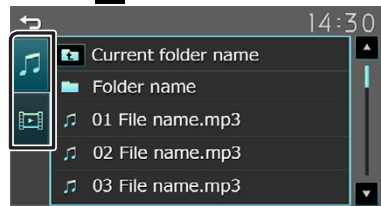

- 5  : You can adjust image quality in video screen.
- [Brightness]** : Adjusts the brightness. (0 to 10)
  - [Contrast]** : Adjusts the contrast. (0 to 10)
  - [Color]** : Adjusts the color. (0 to 10)
  - [Tint]** : Adjusts the tint. (0 to 10)
  - [INITIALIZE]** : To clear the adjustment.
- 6  : Plays or pauses.
- ,  : Searches the previous/next content.
- Touch and hold to fast forward or fast backward.
-  : Searches file. (P.7)
- [NORMAL]/[16:9]/[4:3]** : Select a screen mode.

### ■ Selecting a track in a list (Searches file)

- 1 Touch [Q].
- 2 Select whether you search by audio files , video files .



- 3 Touch  to moves to the upper hierarchy.
  - 4 Touch the desired folder.  
When you touch a folder its contents are displayed.
    - Touch  to moves to the upper hierarchy.
  - 5 Touch desired item from the content list.  
Playback starts.
-  **NOTE**
- The source control screen appears when you touch  at the top hierarchy.

# iPhone

## Preparation

### Connecting iPhone

- For details about connecting iPhone, see page 21.

#### 1 Remove the cap of the USB terminal.

#### 2 Connect the iPhone.

The unit reads the device and playback starts.

### To disconnect the iPhone

#### 1 Press the <⏏> button.

#### 2 Touch a source other than [iPhone].

#### 3 Detach the iPhone.

### Connectable iPhone

The following models can be connected to this unit.

Made for

- |                              |                     |
|------------------------------|---------------------|
| • iPhone 14 Pro Max          | • iPhone 11 Pro Max |
| • iPhone 14 Pro              | • iPhone 11 Pro     |
| • iPhone 14 Plus             | • iPhone 11         |
| • iPhone 14                  | • iPhone XS Max     |
| • iPhone 13 Pro Max          | • iPhone XS         |
| • iPhone 13 Pro              | • iPhone XR         |
| • iPhone 13                  | • iPhone X          |
| • iPhone 13 mini             | • iPhone 8 Plus     |
| • iPhone 12 Pro Max          | • iPhone 8          |
| • iPhone 12 Pro              | • iPhone 7 Plus     |
| • iPhone 12                  | • iPhone 7          |
| • iPhone 12 mini             | • iPhone SE         |
| • iPhone SE (2nd generation) | • iPhone 6s Plus    |
|                              | • iPhone 6s         |

### NOTE

- If you start playback after connecting the iPhone, the music that has been played by the iPhone is played first.
- Cap the USB terminal whenever not using.

## Playback operations

### Control the music you are listening to on the source control screen.

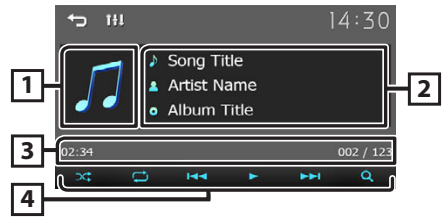

1 Artwork (Shown if the track contains artwork)

2 Displays the information of the current file.

3 Playing time/File number

Play time bar : For confirmation of current playing position.

4 [⏮]: Selects Random playback mode.

[🔀]: Functions the same as Shuffle Songs.

[⏭]: Random off

[🔁]: Selects Repeat playback mode.

[🔁]: Functions the same as Repeat All.

[🔁]: Functions the same as Repeat One.

[🔁]: Repeat off

[▶], [⏸]: Plays or pauses.

[⏮], [⏭]: Searches the previous/next content.

Touch and hold to fast forward or fast backward.

[🔍]: Searches content. (P.8)

### Selecting a content in a list

#### 1 Touch [Q].

#### 2 Touch desired item.

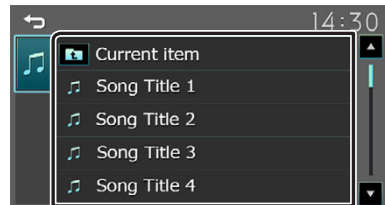

When you touch a category its contents are displayed.

#### 3 Touch desired item from the content list.

Playback starts.

- Touch [⏪] to moves to the upper hierarchy.

### NOTE

- The source control screen appears when you touch [⏪] at the top hierarchy.



# Mirroring

## Preparation

You can display and control the App on the unit while your smartphone is connected to the USB terminal.

### NOTE

- Pair your smartphone with the unit via Bluetooth. See **Register your smartphone to the unit (P.12)** and Connect the Bluetooth device.

### Compatible Android smartphone

- Android version 7.0 or later
- Bluetooth support

### NOTE

- This unit may not work for some Android smartphone's.

### Connecting Android smartphone

#### 1 Download Mirroring App from Google Play.

Install the latest version of the Mirroring application "Mirroring OB for JVC" on your Android.

#### 2 Remove the cap of the USB terminal.

#### 3 Connect the Android smartphone. (P.21)

#### 4 Launch Mirroring App on your Android Smartphone.

- 1) Touch to check mark.

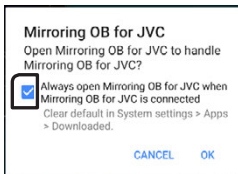

- 2) Touch "OK" to start Mirroring App.

- 3) Touch to check mark.

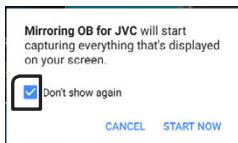

or) the authorization prompt only for android version 10.0 or above.

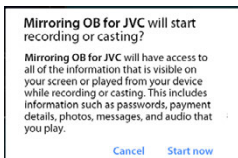

- 4) Touch "START NOW" to start capturing your Android screen.

#### 5 Start to enjoy Mirroring.

### To disconnect the Android smartphone

- 1 Press the <Home> button.
- 2 Touch a source other than [Mirroring].
- 3 Detach the Android smartphone.

## Mirroring operations

### Mirroring Operation

#### 1 Touch [Mirroring].

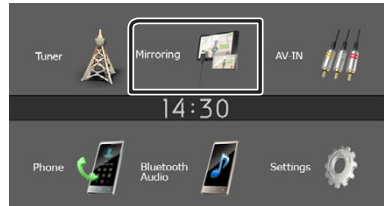

- You can display the same screen of the Android device on the monitor of the unit.

### To turn off the Mirroring

#### 1 Press the <Home> button.



- HOME screen appears.

# External Components

## Using external audio/video players

### Starting playback

- 1 Connect an external component to the AV-IN input terminal. (P.20)
- 2 Press the <img alt="Home button icon" data-bbox="178 171 201 188"/> button.
- 3 Touch [AV-IN].
- 4 Turn on the connected component and start playing the source.

### For Video playback

- 1 When the operation buttons are not displayed on the screen, touch the display.

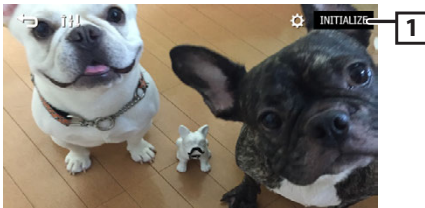

- 1 : You can adjust image quality in video screen.

**[INITIALIZE]**: To clear the adjustly.

### NOTE

- When the picture from the rear view camera is displayed on the AV-IN screen, the picture output from the Visual Output terminal disappears.

## Rear view camera

To use a rear view camera, the REVERSE lead connection is required. For connecting a rear view camera. (P.20)

### Displaying the picture from the rear view camera

The rear view screen is displayed when you shift the gear to the reverse (R) position.



- The first touch removes the Caution, and the second touch closes the Camera Screen.

## External Components

### To adjust the parking guidelines

#### NOTE

- Install the rear view camera in the appropriate position according to the instruction manual supplied with the rear view camera.
- When adjusting the parking guidelines, make sure to apply the parking brake to prevent the car from moving.

**1** Press the <> button.

**2** Touch [Settings].

**3** Touch [System].

**4** Touch [] or [] of [Parking Guidelines] and set to [ON].

**5** Touch [Guidelines SETUP].

**6** Adjust the parking guidelines by selecting the [] mark.

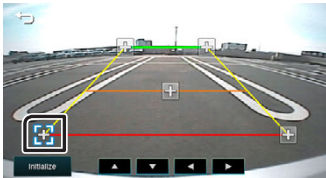

**7** Adjusting the position of the selected mark.

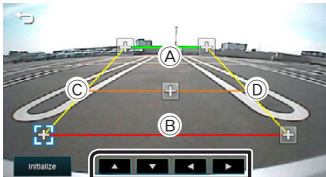

Make sure that lines A and B are horizontally parallel, and that lines C and D are of the same length.

#### NOTE

- Touch [Initialize] and then touch [Yes] to set all the marks to their initial default position.

### Learning function of steering remote

This function is available only when your vehicle is equipped with the electrical steering remote controller.

**1** Press the <> button.

**2** Touch [Settings].

**3** Touch [System].

**4** Touch [Steering Remote].

**5** Touch the function you want to set.

**6** Press and hold the steering remote controller button.

#### NOTE

- You can have the unit learned all buttons at a time. In that case, press the all buttons one at a time and after pressing all of them, touch [] in Steering Remote Controller Setting screen.

**7** Repeat steps 5 and 6 as necessary.

**8** Touch [].

#### NOTE

- Touch [Initialize] and then touch [Yes] to set all the settings to the initial default settings.

### Reverse with ATT (-20dB)

When the gear is shifted to the reverse (R) position, the volume of the device is adjusted.

**1** Press the <> button.

**2** Touch [Settings].

**3** Touch [System].

**4** Touch [Reverse with ATT].

**5** Touch [] or [] set to [ON]/[OFF].

#### NOTE

- The setting value is ON (default)

# Bluetooth

## About the Bluetooth smartphone and Bluetooth audio player

This unit conforms to the following Bluetooth specifications:

### Version

Bluetooth Ver.5.0

### Profile

#### Smartphone/ Cell-phone:

HFP (V1.6) (Hands Free Profile)

PBAP (Phonebook Access Profile)

#### Audio player:

A2DP (Advanced Audio Distribution Profile)

AVRCP (V1.5) (Audio/Video Remote Control Profile)

### Sound codec

SBC

AAC

## About mobile phones compatible with Phone book Access Profile (PBAP)

If your mobile phone supports PBAP, you can display the following items on the touch panel screen when the mobile phone is connected.

- Phone book (up to 1000 entries)
- Dialed calls, received calls, and missed calls (up to 50 entries in total)

## Register your smartphone to the unit

You can use your Bluetooth smartphone when paired to this unit.

You can register up to 8 Bluetooth devices.

- You can pair the device and the unit using SSP (Secure Simple Pairing) which only requires confirmation.
- One device can be connected at a time.
- When you register a new Bluetooth device, disconnect the Bluetooth device currently connected and then register the new device.
- A new device cannot be registered if there are 8 registered Bluetooth units. Delete unnecessary registration. **(P.12)**

**1 Turn on the Bluetooth function on your smartphone/cell-phone.**

**2 Search the unit ("KW-M180BT") from your smartphone/cell-phone.**

If a PIN code is required, enter the PIN code ("0000").

-  appears when the Bluetooth smartphone is connected.

## Disconnecting the device

- Turn off the Bluetooth function from your smartphone/cell-phone.
- Turn off the ignition switch.

## Bluetooth Setup

**1 Press the <Home> button.**

**2 Touch [Settings].**

**3 Touch [Bluetooth].**

**4 Touch the corresponding key and set the value.**

### [Select Device]

Connect the Bluetooth device.

### [Phone Auto Answer]

Set the automatic response time to pick-up an incoming call.

"OFF" (Default) / "ON"

### [Device Name]

The Bluetooth device name of this unit is displayed.

### [Pin Code]

Displays the PIN code.

### [Device address]

Displays the device address.

## Connect the Bluetooth device

**1 Touch [Select Device] on the Bluetooth Setup screen.**

**2 Touch [ ] of the device you want to connect.**



## To delete the registered Bluetooth device

**1 Touch [ ] on the Select Device screen.**

# Bluetooth

## Receive a phone call

1 Touch [📞].

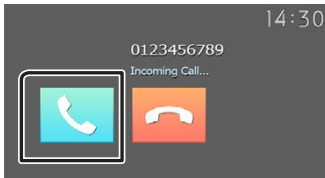

- [📞]: Reject an incoming call.

### Operations during a call

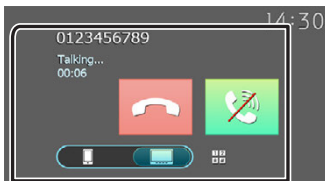

- [📞] Ending a call
- [📞] Mute your voice
- [1 2 #] You can send tones by touching desired keys on the screen.
  - Touch [👉] to close the window.
- [📞] Switches the speaking voice output between smartphone/cell-phone and speaker.

- **Adjust the receiver volume**  
Press the <+> or <-> button.

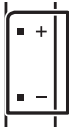

## Make a phone call

1 Press the <🏠> button.

2 Touch [Phone].

3 See the table below for each operation method.

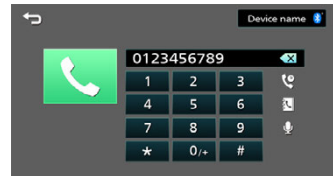

### Call by entering a phone number

- 1) Enter a phone number with number keys.
- 2) Touch [📞].
  - Make a call
  - Touch [✖] to delete the last entry.

### Call using call records

- 1) Touch [📞].
- 2) Touch [📞] (Incoming Calls), [📞] (Outgoing Calls), [📞] (Missed Calls).
- 3) Select the phone number from the list.

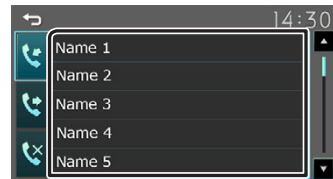

Make a call

### Call using the phonebook

- 1) Touch [📞].
- 2) Select the name from the list.

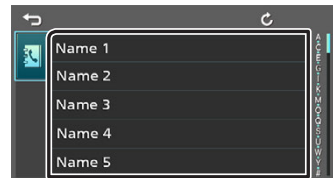

Make a call

- [🔄]: Updates the phonebook. Touch this button after you have made a change to the phonebook of your smartphone/cell-phone.

# Bluetooth

## Call by voice

You can make a voice call using the voice recognition function of the Bluetooth smartphone.

- 1) Touch [🎤].
- 2) Say the name registered in the Bluetooth smartphone.

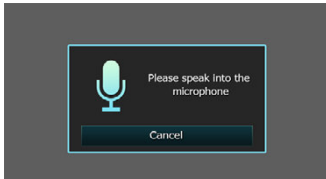

- Touch [Cancel] to cancel voice dialing.

## Call Waiting

When you receive a new call while talking on the phone:

- 1) Touch [📞], the current call is put on hold and you can answer the newly received call.
- 2) Each time you touch [📞], the caller will change to the other one.
- 3) If you touch [📞] during call waiting, reject an incoming call.
- 4) If you touch [📞], when someone is on hold, the current call will end to be switched to the call waiting on hold.
- 5) Touch [🔇] mute your voice

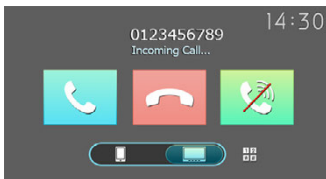

## Playing Bluetooth Audio Device

1 Press the <🏠> button.

2 Touch [Bluetooth Audio].

🗄️ **Source control screen**

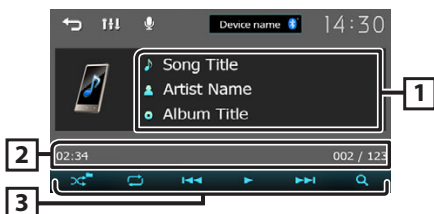

1 Displays the information of the current file.

2 Playing time/File number

**Play time bar** : For confirmation of current playing position.

3 [🎲] : Selects Random playback mode.

[🎲] : Randomly plays all files.

[🎲] : Random off

[🔁] : Selects Repeat playback mode.

[🔁] : Repeats all files.

[🔁] : Repeats the current file.

[🔁] : Repeat off

[▶️], [⏸️] : Plays or pauses.

[⏮️], [⏭️] : Searches the previous/next content.

Touch and hold to fast forward or fast backward.

[🔍] : Searches file. **(P.14)**

### 📎 NOTE

- Operations and display indications may differ according to their availability on the connected device.

## 🗄️ **Selecting a content in a list**

1 Touch [Q].

2 Touch desired item.



When you touch a category its contents are displayed.

3 **Touch desired item from the content list.**

Playback starts.

- Touch [↶] to moves to the upper hierarchy.

### 📎 NOTE

- The source control screen appears when you touch [↶] at the top hierarchy.

# Controlling Audio

You can adjust various settings such as audio balance or subwoofer level.

- 1 Press the <EQ> button.
- 2 See the below for each operation method.



## Controlling General Audio

- 1 Press the <EQ> button.
- 2 Touch [Fader / Balance].
- 3 Set each item as follows.

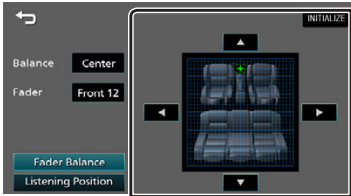

### [Fader Balance]

<b>Balance</b> [◀][▶]	Adjust the left and right volume balance. 15 (left) to 15 (right)
<b>Fader</b> [▲][▼]	Adjust the front and rear volume balance. 15 (front) to 15 (rear)
<b>[INITIALIZE]</b>	To clear the adjustment.

### [Listening Position]

<b>[●]</b>	Select a listening position from "Front Left", "Front All", "Front Right", and "Middle".
<b>[INITIALIZE]</b>	To clear the adjustment.

## Equalizer Control

- 1 Press the <EQ> button.
- 2 Touch [Equalizer].
- 3 Set each item as follows.

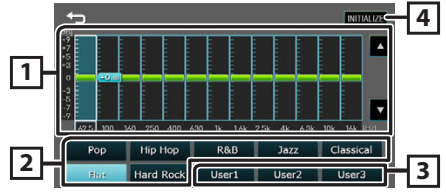

- 1 You can select frequency bar and adjust its level. (-9 to +9)
  - The adjustments are stored.
- 2 To recall the preset equalizer curve.
- 3 Recalls the memorized EQ curve.
- 4 Initialize the current EQ curve.

# Controlling Audio

## Speaker / X'over setup

- 1 Press the <EQ> button.
- 2 Touch [Speaker / X'over].
- 3 Touch the speaker to set up.

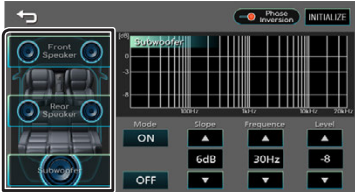

### 4 Set each item as follows.

<b>Mode</b> [OFF], [ON]	[ON] : Filter adjustment. [OFF] : Turns off the filter.
<b>Slope</b> [▲][▼]	Set a crossover slope.
<b>Frequency</b> [▲][▼]	<ul style="list-style-type: none"> <li>• High Pass Filter adjustment. (When Front or Rear is selected)</li> <li>• Low Pass Filter adjustment. (When Subwoofer is selected)</li> </ul>
<b>Level</b> [▲][▼]	Adjust the gain of the front speaker, rear speaker, or subwoofer.
<b>Phase Inversion</b>	Set the phase of subwoofer output. [ ] to shift the phase 180 degrees. (When Subwoofer is selected)
[INITIALIZE]	To clear the adjustment.

## Listening Position DTA

- 1 Press the <EQ> button.
- 2 Touch [Position DTA].
- 3 Touch [Delay].
- 4 Touch [◀] or [▶] to adjust the delay time of the selected speaker.

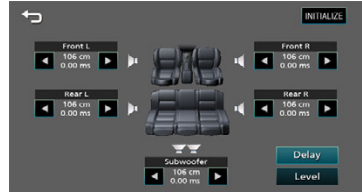

- 5 Touch [Level].
- 6 Touch [◀] or [▶] to adjust the sound level of the selected speaker.

## Sound Effect

- 1 Press the <EQ> button.
- 2 Touch [Sound Effect].
- 3 Set each item as follows.

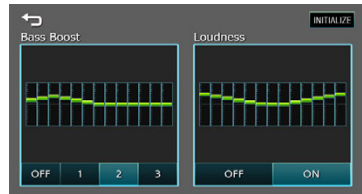

<b>Bass Boost</b> [OFF], [1], [2], [3]	Set the amount of bass boost
<b>Loudness</b> [OFF], [ON]	Set the amount of boost of low and high tones.
[INITIALIZE]	To clear the adjustment.



# Remote control

This unit can be operated using the remote control. The remote control RM-RK258 (optional accessory) can be used.

## ⚠️ Ⓡ WARNINGS

- Do not ingest the battery, Chemical Burn Hazard. The remote control supplied with this product contains a coin/button cell battery. If the coin/button cell battery is swallowed, it can cause severe internal burns in just 2 hours and can lead to death. Keep new and used batteries away from children. If the battery compartment does not close securely, stop using the product and keep it away from children.

If you think batteries might have been swallowed or placed inside any part of the body, seek immediate medical attention.

## For Australia

- If it is suspected a button/coin battery has been swallowed or otherwise placed inside any part of the body, a person should contact the Australian Poisons Information Centre on 13 11 26 immediately for 24/7 fast, expert advice.

## ⚠️ CAUTION

- Risk of fire or explosion if the battery is replaced by an incorrect type. Ensure to replace only with the same type.
- Risk of fire, explosion or the leakage of flammable liquid or gas if the battery is left in an extremely high temperature surrounding environment and/or subjected extremely low air pressure. The battery pack or batteries shall not be exposed to excessive heat such as sunshine, fire or the like.
- Risk of fire, explosion or the leakage of flammable liquid or gas if the battery is disposed into fire or a hot oven, recharged, shorted, mechanically crushed or cut of the battery.
- If spilled fluid comes in contact with your eyes or on clothing, immediately rinse with water and consult a physician.

## Battery Installation



- Use a commercially available button battery (CR2025).
- Insert the battery with the + and - poles aligned properly.
  - If the effectiveness of the remote controller decreases, replace the battery.

## Functions of the Remote control Buttons

- Aim the remote control directly at the remote sensor on the faceplate.
- DO NOT expose the remote sensor to bright light (direct sunlight or artificial lighting).

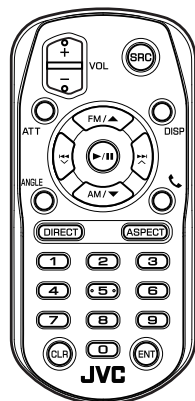

<b>SRC</b>	<ul style="list-style-type: none"> <li>Switches to the source to be played.</li> <li>In hands-free mode, hangs up the phone</li> </ul>
<b>VOL + -</b>	Adjusts the volume.
<b>ATT</b>	Mutes/restores the sound
<b>DISP</b>	Not used.
<b>FM/▲ AM/▼</b>	During tuner source, select FM/ AM band to be received.
<b>◀◀ ◻ ▶▶ ▲</b>	Selects the track or file to be played. For the tuner sources, switches to broadcast stations received by the unit
<b>ANGLE</b>	Not used
<b>▶/  </b>	Plays or pauses.
<b>☎</b>	When a call comes in, answers the call.
<b>DIRECT</b>	Not used.
<b>ASPECT</b>	Not used.
<b>Numeric Keypad</b>	Not used.
<b>CLR</b>	Clears the telephone number input on the Phone screen.
<b>ENT</b>	Not used.

# Installation

## Before Installation

Before installation of this unit, please note the following precautions.

### ▲WARNINGS

- If you connect the ignition wire (red) and the battery wire (yellow) to the car chassis (ground), you may cause a short circuit, that in turn may start a fire. Always connect those wires to the power source running through the fuse box.
- Do not cut out the fuse from the ignition wire (red) and the battery wire (yellow). The power supply must be connected to the wires via the fuse.

### ▲CAUTION

- Install this unit in the console of your vehicle. Do not touch the metal part of this unit during and shortly after the use of the unit. Metal part such as the heat sink and enclosure become hot.

### NOTE

- Mounting and wiring this product requires skills and experience. For best safety, leave the mounting and wiring work to professionals.
- Make sure to ground the unit to a negative 12V DC power supply.
- Do not install the unit in a spot exposed to direct sunlight or excessive heat or humidity. Also avoid places with too much dust or the possibility of water splashing.
- Do not use your own screws. Use only the screws provided. If you use the wrong screws, you could damage the unit.
- If your car's ignition does not have an ACC position, connect the ignition wires to a power source that can be turned on and off with the ignition key. If you connect the ignition wire to a power source with a constant voltage supply, such as with battery wires, the battery may be drained.
- If the console has a lid, make sure to install the unit so that the front panel will not hit the lid when closing and opening.
- If the fuse blows, first make sure the wires aren't touching to cause a short circuit, then replace the old fuse with one with the same rating.
- Insulate unconnected wires with vinyl tape or other similar material. To prevent a short circuit, do not remove the caps on the ends of the unconnected wires or the terminals.
- Secure the wires with cable clamps and wrap vinyl tape around the wires that comes into contact with metal parts to protect the wires and to prevent short circuit.

- Connect the speaker wires correctly to the terminals to which they correspond. The unit may be damaged or fail to work if you share the ⊖ wires or ground them to any metal part in the car.
- When only two speakers are being connected to the system, connect the connectors either to both the front output terminals or to both the rear output terminals (do not mix front and rear). For example, if you connect the ⊕ connector of the left speaker to a front output terminal, do not connect the ⊖ connector to a rear output terminal.
- After the unit is installed, check whether the brake lamps, blinkers, wipers, etc. on the car are working properly.
- Mount the unit so that the mounting angle is 30° or less.
- Do not press hard on the panel surface when installing the unit to the vehicle. Otherwise scars, damage, or failure may result.
- Reception may drop if there are metal objects near the Bluetooth antenna.



Bluetooth antenna unit

# Installation

## Supplied accessories for installation

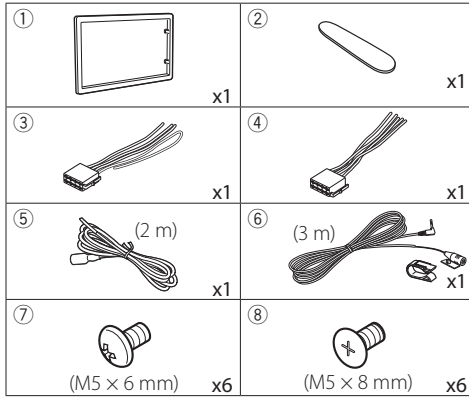

## Installation procedure

- 1) To prevent a short circuit, remove the key from the ignition and disconnect the  $\ominus$  terminal of the battery.
- 2) Make the proper input and output wire connections for each unit.
- 3) Connect the wire on the wiring harness.
- 4) Take Connector B on the wiring harness and connect it to the speaker connector in your vehicle.
- 5) Take Connector A on the wiring harness and connect it to the external power connector on your vehicle.
- 6) Connect the wiring harness connector to the unit.
- 7) Install the unit in your car.
- 8) Reconnect the  $\ominus$  terminal of the battery.
- 9) Press the reset button.

## Installing the unit

### Japanese cars

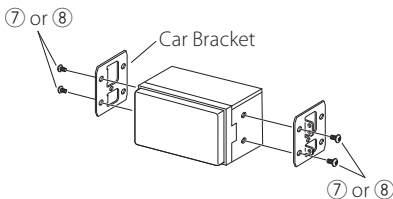

### Trim plate

- 1) Attach accessory ① to the unit.

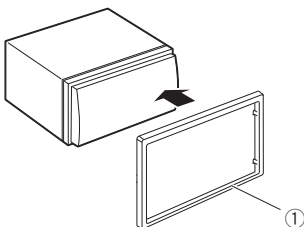

## Microphone unit

- 1) Check the installation position of the microphone (accessory ⑥).
- 2) Clean the installation surface.
- 3) Remove the separator of the microphone (accessory ⑥), and stick the microphone to the place shown below.
- 4) Wire the microphone cable up to the unit with it secured at several positions using tape or other desired method.
- 5) Adjust the direction of the microphone (accessory ⑥) to the driver.

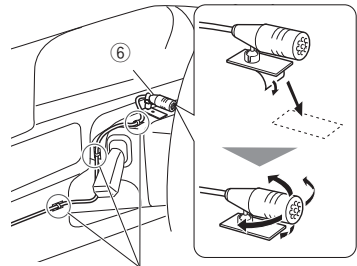

Fix a cable with a commercial item of tape.

### NOTE

- Swap the clips if necessary.

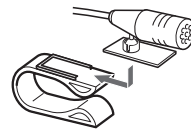

## Removing the trim plate

- 1) Use the extraction key (accessory ②) to lever out the four tabs (two on the left part, two on the right part).

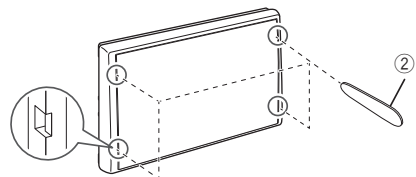

- 2) Pull the trim plate forward.

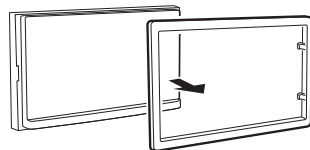

# Installation

## Connecting wires to terminals

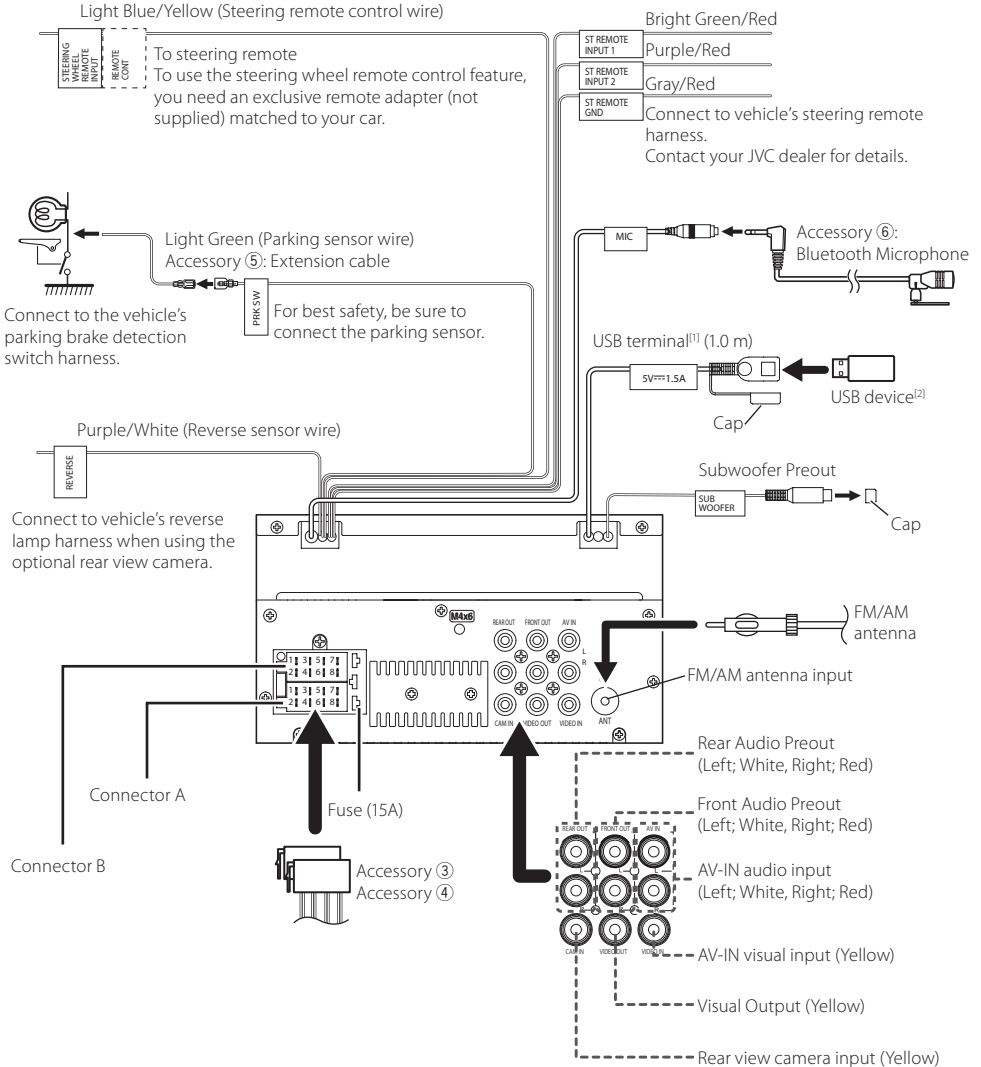

<sup>[1]</sup> USB maximum power supply current :  
DC 5 V  $\overline{DC}$  1.5 A

<sup>[2]</sup> Sold separately

# Installation

## ■ Connecting an iPhone/Android

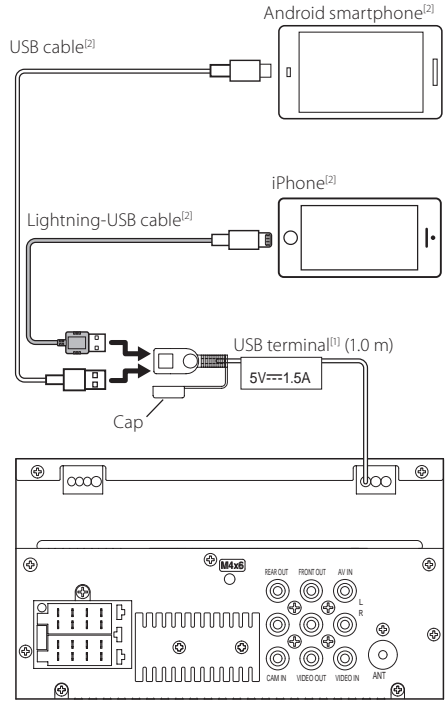
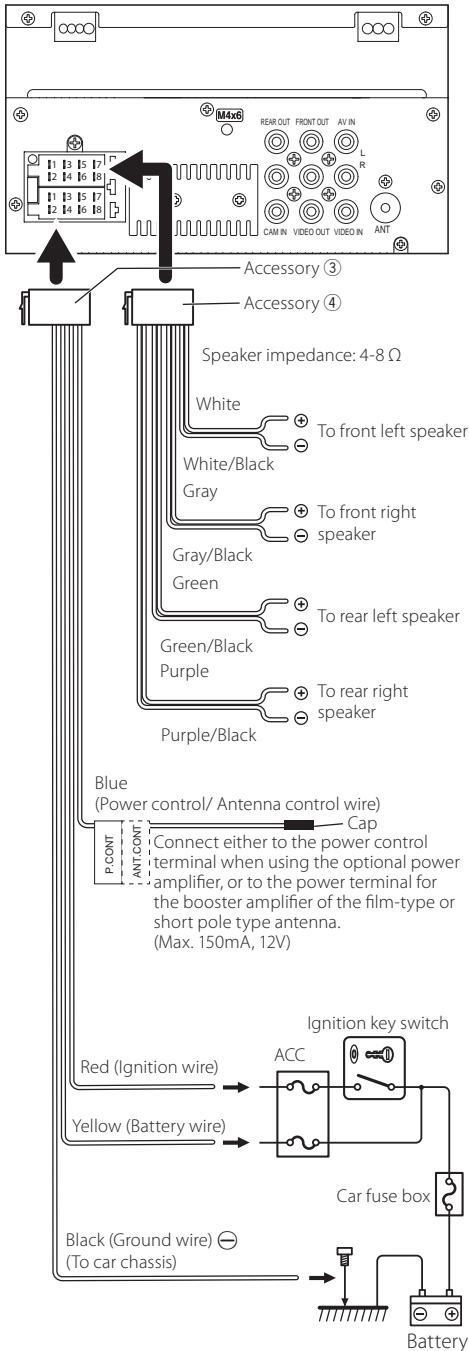

<sup>[1]</sup> USB maximum power supply current :  
DC 5 V --- 1.5 A

<sup>[2]</sup> Sold separately

# About this Unit

## More information

### Usable USB device

This unit can play MPEG1/ MPEG2/ MPEG4/ H.264/ MKV/ MP3/WMA/ AAC/ WAV/ FLAC/ OGG files stored in a USB mass storage class device.

- File system: FAT16/FAT32 /NTFS/ exFAT
- This unit can recognize a total of 9,999 files and 320 folders (a maximum of 9,999 files per folder).
- The maximum number of characters:
  - Folder names : 70 characters
  - File names : 70 characters
  - Tag : 70 characters

### NOTE

- When the USB device is connected to this unit, it can be charged through the USB cable.
- Install the USB device in the place where it will not affect safe driving.
- You cannot connect a USB device via a USB hub and Multi Card Reader.
- Take backups of the audio files used with this unit. The files may be erased depending on the operating conditions of the USB device.  
We shall have no compensation for any damage arising from any erased data.
- No USB device comes with this unit. You need to purchase a commercially available USB device.
- Cap the USB terminal whenever not using.

### Playable Audio files

Audio format	Bit rate/ (Bit count)	Sampling frequency
MP3 (.mp3)	16 – 320kbps, VBR	16 – 48 kHz
WMA (.wma)	16 – 320kbps	16 – 48 kHz
AAC-LC (.m4a)	16 – 320kbps	16 – 48 kHz
Linear PCM (WAVE) (.wav)	(16/24 bit)	8 – 192 kHz
FLAC (.flac)	(16/24 bit)	8 – 192 kHz
Vorbis (.ogg)	(16/24 bit)	8 – 192 kHz

- This unit can show ID3 Tag Version 1.0/1.1/2.2/2.3/2.4 (for MP3).

### NOTE

- WMA and AAC of which is covered with DRM cannot be played.
- Although the audio files are complied with the standards listed above, the play may be impossible depending on the types or conditions of media or device.

### Acceptable Video files

Video format	Video codec	Audio codec
MPEG-1 (.mpg, .mpeg)	MPEG-1	MPEG Audio Layer 2
MPEG-2 (.mpg, .mpeg)	MPEG-2	MPEG Audio Layer 2
MPEG-4 (.mp4, .avi)	MPEG-4 (SP,ASP)	MP3, AAC-LC (2ch)
H.264/MPEG-4 AVC (.mp4, .mkv, .avi, .flv, .f4v)	H.264/MPG-4 AVC (BP/MP/HP)	MP3, AAC (2ch)
MKV (.mkv)	Video Format follows H.264/ MPEG-4 AVC, MPEG4, XVID	MP3, AAC, Vorbis, FLAC

## About this Unit

### Troubleshooting

What appears to be trouble is not always serious. Check the following points before calling a service center.

- For operations with the external components, refer also to the instructions supplied with the adapters used for the connections (as well as the instructions supplied with the external components).

#### General

##### No sound comes out of the speakers.

- Adjust the volume to the optimum level.
- Check the cords and connections.

##### The unit does not work at all.

- Reset the unit. **(P.2)**

##### The remote controller does not work.

- Replace the battery.

#### USB

##### While playing a track, sound is sometimes interrupted.

- The tracks are not properly copied into the USB device. Copy the tracks again, and try again.

#### iPhone

##### No sound comes out of the speakers.

- Disconnect the iPhone, then connect it again.
- Select another source, then reselect "iPhone".

##### The iPhone does not turn on or does not work.

- Check the connecting cable and its connection.
- Update the firmware version of iPhone.
- Charge the battery of iPhone.
- Reset the iPhone.

##### Sound is distorted.

- Deactivate the equalizer either on this unit or the iPhone.

##### A lot of noise is generated.

- Turn off (uncheck) "VoiceOver" on the iPhone. For details, visit <<https://www.apple.com>>.

#### Tuner

##### Automatic presetting does not work.

- Store stations manually. **(P.6)**

##### Static noise while listening to the radio.

- Connect the antenna firmly.

#### AV-IN

##### No picture appears on the screen.

- Turn on the video component if it is not on.
- Connect the video component correctly.

#### Bluetooth

##### Phone sound quality is poor.

- Reduce the distance between the unit and the Bluetooth mobile phone.
- Move the car to a place where you can get a better signal reception.

##### The sound is interrupted or skipped while using a Bluetooth audio player.

- Reduce the distance between the unit and the Bluetooth audio player.
- Turn off, then turn on the unit. (When the sound is not yet restored) connect the player again.

##### The connected audio player cannot be controlled.

- Check whether the connected audio player supports AVRCP (Audio/Video Remote Control Profile).

##### The Bluetooth device does not detect the unit.

- Search from the Bluetooth device again.
- If you are connected to another Bluetooth device, disconnect the Bluetooth connection.

##### The unit does not pair with the Bluetooth device.

- Turn off, then turn on the Bluetooth device.
- Disconnect the Bluetooth device currently connected and then register the new device. **(P.12)**

## About this Unit

### Specifications

#### Monitor section

##### Picture Size

: 6.75 inches (diagonal) wide  
: 151.8 mm (W) × 79.7 mm (H)  
: 5-15/16 × 3-1/8 inch

##### Display System

: Transparent TN LCD panel

##### Drive System

: TFT active matrix system

##### Number of Pixels

: 1,152,000 (800H x 480V x RGB)

##### Effective Pixels

: 99.99 %

##### Pixel Arrangement

: RGB striped arrangement

##### Back Lighting

: LED

#### USB interface section

##### USB Standard

: USB 2.0 High Speed

##### Compatible Devices

: Mass storage class

##### File System

: FAT16/FAT32 /NTFS/ exFAT

##### Maximum Power Supply Current

: DC 5 V  $\overline{\text{---}}$  1.5A

##### D/A Converter

: 24 Bit

##### Audio Decoder

: MP3/ WMA/ WAV/ AAC/ FLAC

##### Video Decoder

: MPEG1/ MPEG2/ MPEG4/ H.264/ MKV

##### Frequency Response

: 192 kHz : 20 – 20,000 Hz  
: 96 kHz : 20 – 20,000 Hz  
: 48 kHz : 20 – 20,000 Hz  
: 44.1 kHz : 20 – 20,000 Hz

#### Bluetooth section

##### Technology

: Bluetooth Ver.5.0

##### Frequency

: 2.4 – 2.48 GHz

##### RF Output Power (E.I.R.P.)

: +8dBm (MAX)

##### Maximum Communication range

: Line of sight approx. 10m (32.8 ft)

##### Audio Codec

: SBC

: AAC

##### Profile (Multi Profile support)

: HFP (V1.6) (Hands Free Profile)

: A2DP (Advanced Audio Distribution Profile)

: AVRCP (V1.5) (Audio/Video Remote Control Profile)

: PBAP (Phonebook Access Profile)

#### FM tuner section

##### Frequency Range (step)

: 87.5 MHz – 108.0 MHz (50 kHz)

##### Usable Sensitivity

: 16.2 dBf

: 1.8  $\mu\text{V}/75 \Omega$  (S/N : 30 dB)

##### Frequency Response

: 30 Hz – 14 kHz

##### S/N Ratio

: 50 dB (MONO)

##### Stereo Separation

: 35 dB (1 kHz)

#### AM tuner section

##### Frequency Range (step)

: 531 – 1611 kHz (9 kHz)

##### Usable Sensitivity

: 99  $\mu\text{V}$  (40 dB $\mu$ )

#### Video section

##### Color System of External Video Input

: NTSC/PAL

##### External Video Input Level (RCA jacks)

: 1 V<sub>p-p</sub>/ 75  $\Omega$

##### External Video Input Level (RCA jacks, AV-IN)

: 1 V<sub>p-p</sub>/ 75  $\Omega$

##### External Audio Max Input Level (RCA jacks, AV-IN)

: 1.5 V/ 25 k $\Omega$

##### Video Output Level (RCA jacks)

: 1 V<sub>p-p</sub>/ 75  $\Omega$

#### NOTE

- Although the effective pixels for the liquid crystal panel is given as 99.99% or more, 0.01% of pixels may not light or may light incorrectly.
- Specifications subject to change without notice.



## About this Unit

---

### ■ Audio section

Maximum Power (Front & Rear)

: 45 W × 4

Full Bandwidth Power (Front & Rear)

Full Bandwidth Power (at less than 1% THD)

: 16 W × 4

Preout Level (V)

: 2 V / 10 k $\Omega$

Preout Impedance

: 1.4 k $\Omega$

Speaker Impedance

: 4 – 8  $\Omega$

### ■ DSP section

Equalizer

: 13 Band

Band

Frequency: 62.5/100/160/250/400/630/1k/1.6k/2.5k/  
4k/6.3k/10k/16k Hz

Level: -9 – +9 dB

HPF

Frequency: Through / 30/40/50/60/70/80/90/100/  
120/150/180/220/250 Hz

Slope: -6/-12/-18/-24 dB/Oct.

Gain: -8/-7/-6/-5/-4/-3/-2/-1/0 dB

LPF

Frequency: 30/40/50/60/70/80/90/100/120/150/180/  
220/250 Hz / through

Slope: -6/-12/-18/-24 dB/Oct.

Gain: -8/-7/-6/-5/-4/-3/-2/-1/0 dB

Position

Front / Rear / Subwoofer Delay

: 0 – 6.1 m (0.01 m Step)

Gain: -8 – 0 dB

### ■ General

Operating Voltage

: 12V DC car battery

Main Unit Installation size (W × H × D)

: 178 × 100 × 75 mm

Weight

: 1.1 kg

## About this Unit

### Copyrights

- The Bluetooth® word mark and logos are registered trademarks owned by the Bluetooth SIG, Inc. and any use of such marks by JVCKENWOOD Corporation is under license. Other trademarks and trade names are those of their respective owners.
- Use of the Made for Apple badge means that an accessory has been designed to connect specifically to the Apple product(s) identified in the badge and has been certified by the developer to meet Apple performance standards. Apple is not responsible for the operation of this device or its compliance with safety and regulatory standards. Please note that the use of this accessory with an Apple product may affect wireless performance.
- Apple, iPhone and Lightning are trademarks of Apple Inc., registered in the U.S. and other countries.
- Android is a trademark of Google LLC.
- Microsoft and Windows Media are either registered trademarks or trademarks of Microsoft Corporation in the United States and/or other countries.
- THIS PRODUCT IS LICENSED UNDER THE MPEG-4 VISUAL PATENT PORTFOLIO LICENSE FOR THE PERSONAL AND NON-COMMERCIAL USE OF A CONSUMER FOR (j) ENCODING VIDEO IN COMPLIANCE WITH THE MPEG-4 VISUAL STANDARD ("MPEG-4 VIDEO") AND/OR (jj) DECODING MPEG-4 VIDEO THAT WAS ENCODED BY A CONSUMER ENGAGED IN A PERSONAL AND NON-COMMERCIAL ACTIVITY AND/OR WAS OBTAINED FROM A VIDEO PROVIDER LICENSED BY MPEG LA TO PROVIDE MPEG-4 VIDEO. NO LICENSE IS GRANTED OR SHALL BE IMPLIED FOR ANY OTHER USE. ADDITIONAL INFORMATION INCLUDING THAT RELATING TO PROMOTIONAL, INTERNAL AND COMMERCIAL USES AND LICENSING MAY BE OBTAINED FROM MPEG LA, LLC. SEE [HTTP://WWW.MPEGLA.COM](http://www.MPEGLA.COM).
- THIS PRODUCT IS LICENSED UNDER THE AVC PATENT PORTFOLIO LICENSE FOR THE PERSONAL USE OF A CONSUMER OR OTHER USES IN WHICH IT DOES NOT RECEIVE REMUNERATION TO (j) ENCODE VIDEO IN COMPLIANCE WITH THE AVC STANDARD ("AVC VIDEO") AND/OR (jj) DECODE AVC VIDEO THAT WAS ENCODED BY A CONSUMER ENGAGED IN A PERSONAL ACTIVITY AND/OR WAS OBTAINED FROM A VIDEO PROVIDER LICENSED TO PROVIDE AVC VIDEO. NO LICENSE IS GRANTED OR SHALL BE IMPLIED FOR ANY OTHER USE. ADDITIONAL INFORMATION MAY BE OBTAINED FROM MPEG LA, L.L.C. SEE [HTTP://WWW.MPEGLA.COM](http://www.MPEGLA.COM)
- libFLAC  
Copyright (C) 2000-2009 Josh Coalson  
Copyright (C) 2011-2013 Xiph.Org Foundation
  - Redistribution and use in source and binary forms, with or without modification, are permitted provided that the following conditions are met:
  - Redistributions of source code must retain the above copyright notice, this list of conditions and the following disclaimer.

– Redistributions in binary form must reproduce the above copyright notice, this list of conditions and the following disclaimer in the documentation and/or other materials provided with the distribution.

Neither the name of the Xiph.org Foundation nor the names of its contributors may be used to endorse or promote products derived from this software without specific prior written permission.

THIS SOFTWARE IS PROVIDED BY THE COPYRIGHT HOLDERS AND CONTRIBUTORS "AS IS" AND ANY EXPRESS OR IMPLIED WARRANTIES, INCLUDING, BUT NOT LIMITED TO, THE IMPLIED WARRANTIES OF MERCHANTABILITY AND FITNESS FOR A PARTICULAR PURPOSE ARE DISCLAIMED. IN NO EVENT SHALL THE FOUNDATION OR CONTRIBUTORS BE LIABLE FOR ANY DIRECT, INDIRECT, INCIDENTAL, SPECIAL, EXEMPLARY, OR CONSEQUENTIAL DAMAGES (INCLUDING, BUT NOT LIMITED TO, PROCUREMENT OF SUBSTITUTE GOODS OR SERVICES; LOSS OF USE, DATA, OR PROFITS; OR BUSINESS INTERRUPTION) HOWEVER CAUSED AND ON ANY THEORY OF LIABILITY, WHETHER IN CONTRACT, STRICT LIABILITY, OR TORT (INCLUDING NEGLIGENCE OR OTHERWISE) ARISING IN ANY WAY OUT OF THE USE OF THIS SOFTWARE, EVEN IF ADVISED OF THE POSSIBILITY OF SUCH DAMAGE.

- libogg

Copyright (c) 2002, Xiph.org Foundation Redistribution and use in source and binary forms, with or without modification, are permitted provided that the following conditions are met:

– Redistributions of source code must retain the above copyright notice, this list of conditions and the following disclaimer.

– Redistributions in binary form must reproduce the above copyright notice, this list of conditions and the following disclaimer in the documentation and/or other materials provided with the distribution.

– Neither the name of the Xiph.org Foundation nor the names of its contributors may be used to endorse or promote products derived from this software without specific prior written permission.

THIS SOFTWARE IS PROVIDED BY THE COPYRIGHT HOLDERS AND CONTRIBUTORS "AS IS" AND ANY EXPRESS OR IMPLIED WARRANTIES, INCLUDING, BUT NOT LIMITED TO, THE IMPLIED WARRANTIES OF MERCHANTABILITY AND FITNESS FOR A PARTICULAR PURPOSE ARE DISCLAIMED. IN NO EVENT SHALL THE FOUNDATION OR CONTRIBUTORS BE LIABLE FOR ANY DIRECT, INDIRECT, INCIDENTAL, SPECIAL, EXEMPLARY, OR CONSEQUENTIAL DAMAGES (INCLUDING, BUT NOT LIMITED TO, PROCUREMENT OF SUBSTITUTE GOODS OR SERVICES; LOSS OF USE, DATA, OR PROFITS; OR BUSINESS INTERRUPTION) HOWEVER CAUSED AND ON ANY THEORY OF LIABILITY, WHETHER IN CONTRACT, STRICT LIABILITY, OR TORT (INCLUDING NEGLIGENCE OR OTHERWISE) ARISING IN ANY WAY OUT OF THE USE OF THIS SOFTWARE, EVEN IF ADVISED OF THE POSSIBILITY OF SUCH DAMAGE.

## About this Unit



**Declaration of Conformity with regard to the RE Directive 2014/53/EU**

**Declaration of Conformity with regard to the RoHS Directive 2011/65/EU**

**Manufacturer:**

JVCKENWOOD Corporation  
3-12, Moriyacho, Kanagawa-ku, Yokohama-shi, Kanagawa  
221-0022, JAPAN

**EU Representative:**

JVCKENWOOD Europe B.V.  
Remdementsweg 20 B-9, 3641 SL Mijdrecht, THE  
NETHERLANDS

**2014/53/EU RE Direktifi ile Uyumluluk Beyanı**  
**RoHS Direktifi 2011/65/EU için Uyum Beyanı**

**Üretici:**

JVCKENWOOD Corporation  
3-12, Moriyacho, Kanagawa-ku, Yokohama-shi, Kanagawa  
221-0022, JAPONYA

**AB Temsilcisi:**

JVCKENWOOD Europe B.V.  
Remdementsweg 20 B-9, 3641 SL Mijdrecht, THE  
NETHERLANDS

**English**

Hereby, JVCKENWOOD declares that the radio equipment KW-M180BT is in compliance with Directive 2014/53/EU. The full text of the EU declaration of conformity is available at the following internet address:

**Türkçe**

Burada, JVCKENWOOD KW-M180BT radyo ekipmanının 2014/53/AB Direktifine uygun olduğunu bildirir. AB uyumluluk deklarasyonunun tam metni aşağıdaki internet adresinde mevcuttur.

**URL:**<https://www.jvc.net/euukdoc/>

### For Turkey

■ Eski Elektrik ve Elektronik Ekipmanların İmha Edilmesi Hakkında Bilgi (ayrı atık toplama sistemlerini kullanan ülkeleri için uygulanabilir)



Sembollü (üzerinde çarpı işareti olan çöp kutusu) ürünler ev atıkları olarak atılamaz.

Eski elektrik ve elektronik ekipmanlar, bu ürünleri ve ürün atıklarını geri dönüştürebilecek bir tesiste değerlendirilmelidir. Yaşadığınız bölgeye en yakın geri dönüşüm tesisinin yerini öğrenmek için yerel makamlara müracaat edin. Uygun geri dönüşüm ve atık imha yöntemi sağlığımız ve çevremiz üzerindeki zararlı etkileri önlerken kaynakların korunmasına da yardımcı olacaktır.

■ **מידע בדבר השלכה לאשפה של ציוד חשמלי**

**ואלקטרוני ישן וכן סוללות (רלוונטי למדינות**

**שמשמשות במערכת איסוף אשפה מופרדת).**

לא ניתן להשליך מוצרים וסוללות עם הסימון (פח אשפה עם X עליו) כאשפה ביתית רגילה.

יש למחזר ציוד חשמלי ואלקטרוני ישן וכן סוללות במתקן המסוגל לטפל בפריטים כאלה ובתוצרי הלואי שלהם.

צרו קשר עם הרשות המקומית לקבלת פרטים אודות מתקן המיחזור הקרוב אליכם. מיחזור והשלכה לאשפה נאותים יעזרו לשמר משאבים ולמנוע השפעות שליליות על בריאותנו ועל הסביבה.



**JVC**