

# JVC

EN

MULTI FORMAT LCD MONITOR

# DT-E15L4

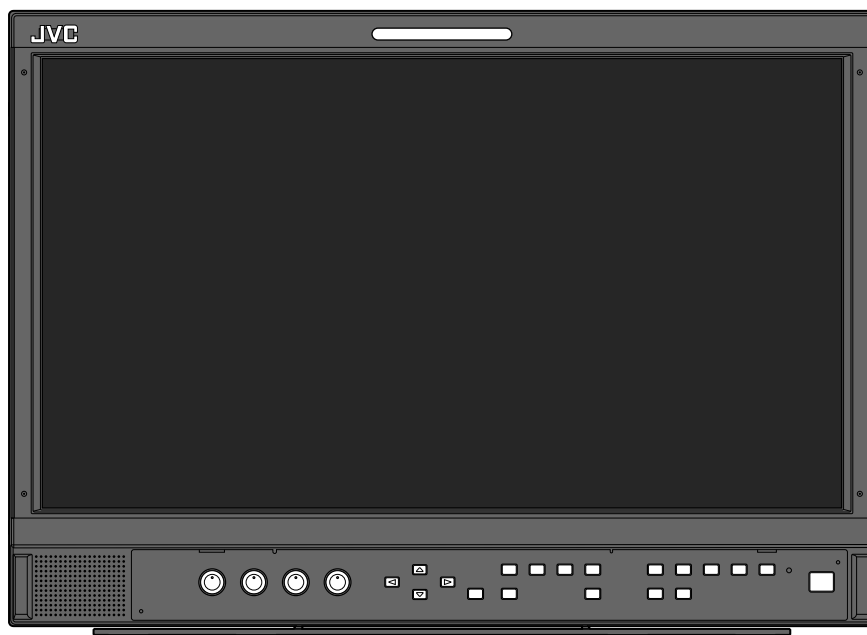

INSTRUCTIONS



**HDMI**<sup>®</sup>  
HIGH-DEFINITION MULTIMEDIA INTERFACE

LCT2714-001A

# Safety Precautions

 <div style="border: 1px solid black; padding: 5px; text-align: center;"> <p><b>CAUTION</b></p> <p><b>RISK OF ELECTRICAL SHOCK</b></p> <p><b>DO NOT OPEN</b></p> </div> 	<p>The lightning flash with arrowhead symbol, within an equilateral triangle is intended to alert the user to the presence of uninsulated "dangerous voltage" within the product's enclosure that may be of sufficient magnitude to constitute a risk of electric shock to persons.</p>
<p><b>CAUTION:</b> To reduce the risk of electric shock. Do not remove cover (or back). No user serviceable parts inside. Refer servicing to qualified service personnel.</p>	<p>The exclamation point within an equilateral triangle is intended to alert the user to the presence of important operating and maintenance (servicing) instructions in the literature accompanying the appliance.</p>

**WARNING:** TO REDUCE RISK OF FIRE OR ELECTRIC SHOCK, DO NOT EXPOSE THIS APPARATUS TO RAIN OR MOISTURE. NO OBJECTS FILLED WITH LIQUIDS, SUCH AS VASES, SHALL BE PLACED ON THE APPARATUS.

**Warning:** This is a class A product. In a domestic environment this product may cause radio interference in which case the user may be required to take adequate measures.

## IMPORTANT SAFEGUARDS

Electrical energy can perform many useful functions. This unit has been engineered and manufactured to assure your personal safety. But **IMPROPER USE CAN RESULT IN POTENTIAL ELECTRIC SHOCK OR FIRE**. In order not to defeat the safeguards incorporated into this product, observe the following basic rules for its installation, use, and service. Please read these "IMPORTANT SAFEGUARDS" carefully before use.

- All the safety and operating instructions should be read before the product is operated.
- The safety and operating instructions should be retained for future reference.
- All warnings on the product and in the operating instructions should be adhered to.
- All operating instructions should be followed.

### POWER CONNECTION

The power supply voltage rating of this product is AC 120 V (For U.S.A. and Canada) and AC 220 – 240 V (For European countries, Asian countries, and United Kingdom).

The power cord attached conforms to the following power supply voltage and countries. Use only the power cord designated to ensure safety and EMC regulations of each country.

- Not all types of power cords are supplied to this product.

For U.S.A. and Canada: AC 120 V	For European and Asian countries: AC 220 – 240 V	For United Kingdom: AC 220 – 240 V
------------------------------------	---	---------------------------------------



This plug will fit only into a grounded power outlet. If you are unable to insert the plug into the outlet, contact your electrician to install the proper outlet. Do not defeat the safety purpose of the grounded plug.

- This product should be operated only with the type of power source indicated on the label. If you are not sure of the type of power supply of your home, consult your product dealer or local electric power company.

**Warning:**

- Do not use the same power cord for AC 120 V as for AC 220 – 240 V. Doing so may cause malfunction, electric shock or fire.

**Note for United Kingdom power cord only**

The plug of United Kingdom power cord has a built-in fuse. When replacing the fuse, be sure to use only a correctly rated approved type, re-fit the fuse cover. (Consult your dealer or qualified personnel.)

**How to replace the fuse**

Open the fuse compartment with the blade screwdriver, and replace the fuse.

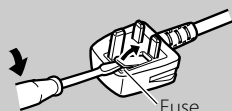

- Before connecting other products such as VCR's and personal computers, you should turn off the power of this product for protection against electric shock.
- Do not use attachments not recommended by the manufacturer as they may be hazardous.
- **When replacement parts are required**, be sure the service technician has used replacement parts specified by the manufacturer or equivalents. Unauthorized substitutions may result in fire, electric shock, or other hazards.
- **Upon completion of any service or repairs to this product**, ask the service technician to perform safety checks to determine that the product is in proper operating condition.

- Do not install this product in the following places:
  - in a damp or dusty room
  - where the product is exposed to soot or steam, such as near the cooking counter or a humidifier
  - near heat sources
  - where condensation easily occurs, such as near the window
  - in a location exposed to direct sunlight or strong light
- Do not place this product on an unstable cart, stand, or table. The product may fall, causing serious injury to a child or adult, and serious damage to the product. The product should be mounted according to the manufacturer's instructions, and should use a mount recommended by the manufacturer.
- Do not use this product near water.
- Be sure to install the product in the place where proper temperature and humidity are kept (see "Operating conditions" on page 27). This product becomes hot during its use. Take enough care when handling the product.

**Under the following conditions,**

- 1. Turn off the power.**
- 2. Unplug this product from the wall outlet.**
- 3. Refer service to qualified service personnel.**
  - a) When the product emits smoke or unusual smell.
  - b) When the product exhibits a distinct change in performance —for example, no picture or no sound.
  - c) If liquid has been spilled, or objects have fallen on the product.
  - d) If the product has been exposed to rain or water.
  - e) If the product has been dropped or damaged in any way.
  - f) When the power supply cord or plug is damaged.

Do not attempt to service this product yourself, as opening or removing covers may expose you to dangerous voltages and other hazards. Refer all service to qualified service personnel.

Do not use the product for a long time if the sound is distorted.

Use only the power source specified on the unit.

- AC power: 120 V/220 - 240 V, 50 Hz/60 Hz

- The AC power supply is controlled by turning on/off the POWER switch on the rear panel. If the product is installed in a place where you cannot easily turn on/off the POWER switch, control the AC power supply by plugging/unplugging the power cord into/from the AC outlet. In this case, install the product as close to the AC outlet as possible, and leave enough space for plugging/unplugging the power cord. If the product is installed in a place where you cannot easily plug/unplug the power cord, equip an easily accessible device to the wiring of the building for turning on/off the power.
- When the product is left unattended and unused for a long period of time, unplug it from the wall outlet and disconnect the cable system.
- Do not overload wall outlets, extension cords, or convenience receptacles on other equipment as this can result in a risk of fire or electric shock.
- Use only the accessory cord designed for this product to prevent shock.

- Slots and openings in the cabinet are provided for ventilation. These ensure reliable operation of the product and protect it from overheating. These openings must not be blocked or covered.
- Never push objects of any kind into this product through openings as they may touch dangerous voltage points or short-circuit the parts, which could result in a fire or electric shock.
- Never spill liquid of any kind on the product.
- Never place anything on the product. (Placing liquids, naked flames, cloths, paper, etc. on the product may cause a fire.)
- Do not apply any strong shock to the LCD panel. (Do not hit any object against it or push it with a sharp-pointed tool.)
- Do not put heavy objects on the product.
- Do not step on or hang on the product.

## WARNING

### To prevent injury by accidental fall

Fix the monitor to a wall by using strings.

#### Fixing the monitor

Attach the hook (not provided) to the VESA mounting holes on the rear panel (use the two holes on the upper side) using M4 x 10 mm screws (not provided). Bind the hooks on the rear panel of the monitor to a wall or a pillar using durable string.

VESA mounting holes

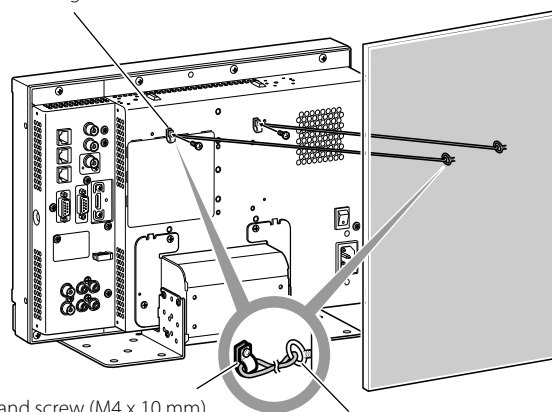

Hook and screw (M4 x 10 mm)  
(not provided)

Hook (not provided)

# Safety Precautions (cont.)

## European Union only

### Dear Customer,

This apparatus is in conformance with the valid European directives and standards regarding electromagnetic compatibility and electrical safety.

European representative of JVC KENWOOD Corporation is:

JVC Technical Services Europe GmbH

Postfach 10 05 04

61145 Friedberg

Germany

### Information for Users on Disposal of Old Equipment



#### [European Union]

This symbol indicates that the electrical and electronic equipment should not be disposed of as general household waste at its end-of-life. Instead, the product should be handed over to the applicable collection point for the recycling of electrical and electronic equipment for proper treatment, recovery and recycling in accordance with your national legislation.

#### Attention:

This symbol is only valid in the European Union.

By disposing of this product correctly, you will help to conserve natural resources and will help prevent potential negative effects on the environment and human health which could otherwise be caused by inappropriate waste

handling of this product. For more information about collection point and recycling of this product, please contact your local municipal office, your household waste disposal service or the shop where you purchased the product.

Penalties may be applicable for incorrect disposal of this waste, in accordance with national legislation.

#### (Business users)

If you wish to dispose of this product, please visit our web page <http://www.jvc.eu/> to obtain information about the take-back of the product.

#### [Other Countries outside the European Union]

If you wish to dispose of this product, please do so in accordance with applicable national legislation or other rules in your country for the treatment of old electrical and electronic equipment.

### EMC Supplement

This equipment is in conformity with the provisions and protection requirements of the corresponding European Directives. This equipment is designed for professional video appliances and can be used in the following environments:

- Controlled EMC environment (for example purpose built broadcasting or recording studio), and rural outdoors environment (far away from railways, transmitters, overhead power lines, etc.)
- In order to keep the best performance and ensure electromagnetic compatibility, we recommend to use cables not exceeding the following length:

Cable	Length
Power cord (attached cable (H05VV-F 3 x 0.75 mm <sup>2</sup> ))	2.0 m
Video signal cable (coaxial cable)	2.0 m
Audio signal cable (shielded cable)	1.5 m
HDMI cable (shielded cable)	2.0 m
DVI cable (shielded cable) with core filter	2.0 m
RS-232C cable (shielded cable) (A straight cable with a D-sub 9-pin connector)	2.0 m
RS-485 cable (twist pair cable) (A straight LAN cable)	2.0 m
REMOTE cable (twist pair cable) (A straight LAN cable)	2.0 m
RGB VGA cable (shielded cable)	2.0 m

*The inrush current of this apparatus is 4.24 ampere.*

#### CAUTION

In case where the strong electromagnetic waves or magnetism are near the audio cable or the signal cable, the sound or the picture will contain noise. In such cases, please keep the cable away from the sources of the disturbance.

# Operating Precautions

The LCD panel and backlight have life expectancy. Due to the basic characteristics of the LCD panel, an afterimage or uneven display may occur. It is recommended that you change images occasionally, activate the power saving function, or often turn off the power to reduce the load on the LCD panel. Continuous operations of the LCD panel may accelerate the deterioration.

## ● Caution for use of the product for many hours

In the case that you use the monitor for many hours, we recommend that you set "No Sync Action" in "Sync Function" to "Power Save" in Main Menu. This will reduce power consumption and relieve strain on the monitor. To reduce damage to the LCD panel, using the LCD Saver function is recommended.

## ● Caution for use of the product in the high temperature

Do not use the product in places of high temperature; otherwise, parts of this product or the LCD panel may be damaged. This product is equipped with a temperature sensor to give warning if the temperature becomes too high. If the temperature exceeds the range of normal use, "Temp. Over" is displayed, and the power is turned off automatically if the temperature becomes any higher. In this case, move the product to a place of low temperature to let it cool down.

## ● Maintenance

**Unplug this product from the wall outlet before cleaning.**

### LCD panel

To avoid irreparable change in appearance of the screen such as uneven color, discoloration, scratches, be careful about the following:

- Do not paste or stick anything using any glues or adhesive tapes.
- Do not write anything on the screen.
- Do not strike the screen with a hard object.
- Avoid condensation on the screen.
- Do not wipe the screen with any liquid such as water. In addition, wiping the screen with water-diluted neutral detergent or solvent such as alcohol, thinner, or benzine may affect the anti-reflection treatment of the screen.
- Do not wipe the screen forcefully.

Wipe stains off the LCD panel with a soft cloth. If the screen gets heavily stained, wipe it with a soft cloth soaked in water-diluted neutral detergent and wrung well, then wipe with a soft dry cloth.

### Cabinet

To avoid the deterioration or damages of the cabinet such as its paint's peeling away, be careful about the following:

- Do not wipe the cabinet using solvent such as alcohol, thinner, or benzine.
- Do not expose the cabinet to any volatile substance such as insecticides.
- Do not allow any rubber or plastic in contact for a long time.
- Do not wipe the cabinet forcefully.

Wipe stains off the cabinet with a soft cloth. If the cabinet gets heavily stained, wipe it with a soft cloth soaked in water-diluted neutral detergent and wrung well, then wipe with a soft dry cloth.

### Ventilation openings

Use a vacuum cleaner to get rid of the dust around the intakes (all the openings). If a vacuum cleaner is not available, use a cloth and wipe it off. Leaving the dust around the intakes may prevent proper temperature control and cause damage to the product.

# Table of Contents

Safety Precautions.....	2	The operation procedure	12
IMPORTANT SAFEGUARDS	2	Menu Transition Diagram	13
Operating Precautions .....	5	Main Menu	14
Caution for use of the product for many hours	5	Set-Up Menu	18
Caution for use of the product in the high temperature	5	External Control .....	22
Maintenance	5	About the external control	22
Installation .....	6	Using the Make/Trigger system	22
Index of Parts and Functions.....	8	Using the serial communication	23
Rear panel	8	Troubleshooting .....	25
Front panel	10	Self-check program	26
Showing Input Signals.....	11	Specifications.....	27
Volume Adjustment/Audio Channel Selection	11	General	27
On the Information Display	11	LCD panel	27
On the Status Display	11	Input/output terminals	27
Menu Configuration.....	12	Dimensions	28
First Time Installation	12	Available signals	29

# Installation

- Do not rest your arm on the monitor or lean against the monitor.
- Do not touch the LCD panel when installing the monitor.
- Be sure to install the monitor securely to prevent the monitor from falling over, which may cause damage to the monitor or injury.

## ● To install the monitor on a shelf or any other suitable surface using screws

You can install the monitor without protruding the stand bottom plate by moving the stand bottom plate to the rear position.

### CAUTION

- Lay the monitor on a cloth with the LCD panel facing down to prevent the LCD panel from being damaged.
- After moving the stand bottom plate to the rear position, be sure to attach the stand with commercially available screws.

1 Loosen the stand screws on the stand support and remove the bottom plate.

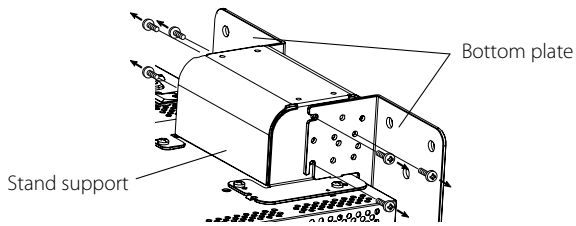

2 Temporarily set the stand screws to screw holes "3" on the right and left sides of the stand support.

- Tighten the temporarily set stand screws so that they protrude from the screw holes by about 4 mm.

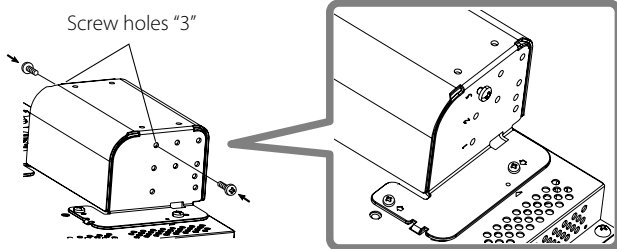

3 Hook right and left recesses "A" onto the temporarily set screws in the stand support.

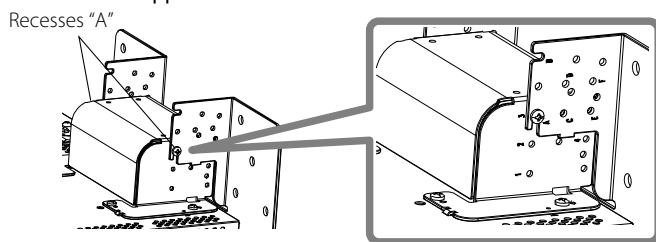

4 Adjust the position so that the screw holes on the stand support align with right and left screw holes "C" and "E" on the bottom plate, tighten the two stand screws on one side (four screws on both sides), and finally retighten the temporarily set screws to lock the stand support and the bottom plate.

Screw holes "C" and "E"

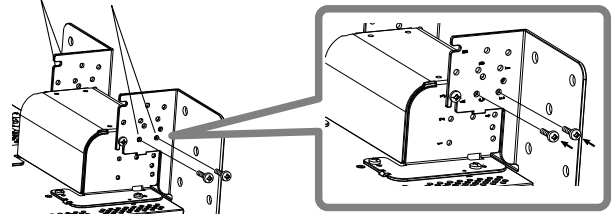

5 Use no less than two commercially available screws (no less than four screws on both sides) for the screw holes (10 - φ8) on the stand bottom plate, to anchor the monitor.

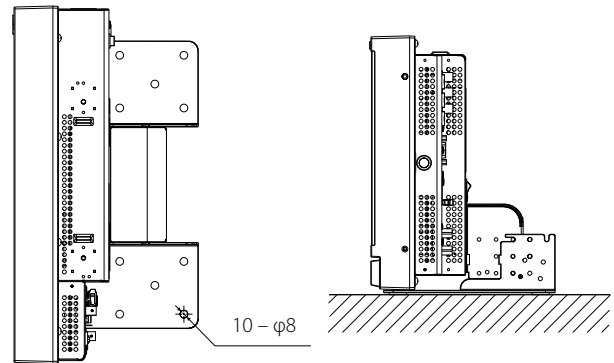

### CAUTION

- Use screws having enough holding strength and resistance against external force of expected vibrations.
- It is very dangerous not to anchor the stand with screws as this may cause not only breakage due to the monitor falling or dropping, but also injury or electrical shock.

## ● To detach the stand

### CAUTION

- Lay the monitor on a cloth with the LCD panel facing down to prevent the LCD panel from being damaged.

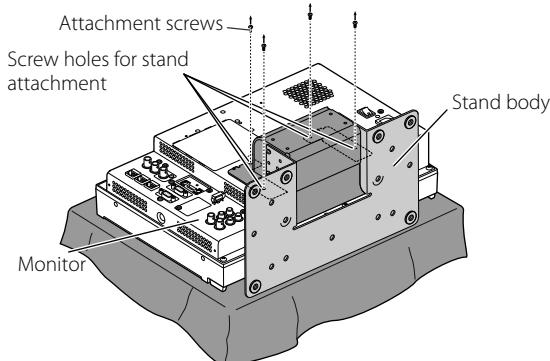

## ● To install the stand

When attaching the stand to the monitor, insert the guides of the stand into the guide holes on the monitor to place the stand in the correct position. Then fix the stand firmly with the attachment screws.

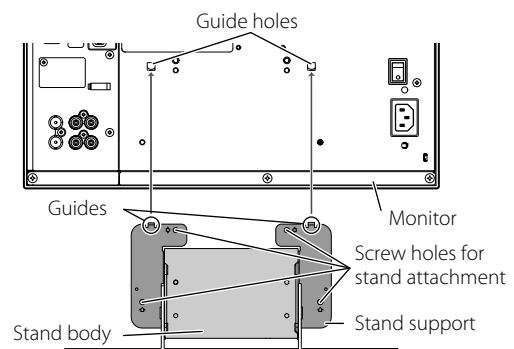

● **To install the monitor on a wall**

You can install the monitor on a wall by changing how the stand bottom plate is attached.

**Installation Only for Authorized Service Personnel**

Consult authorized service personnel for the installation of this unit.

Installation instructions must be followed precisely in order to prevent accidents.

We are selling this product with the understanding that it will be assembled and installed by properly trained and qualified service personnel.

**About Accidents/Damages**

We are not liable for any damage caused by faulty assembly, faulty wall mounting, insecure wall mounting, misuse, alterations, or natural disasters.

- Please be aware that screw holes and anchor bolts will remain in the wall surface if the monitor is removed after having been mounted to the wall.
- Long-term use of the monitor may result in discoloration of the wall surface due to heat/air emitted by the monitor.

**! Danger**

- Consult authorized service personnel for the installation and attachment of this unit to the wall. Do not attempt to mount the unit by yourself.
- Improper assembly or installation may cause the unit to fall when it is mounted, which may result in fatal accidents.
- To prevent this happening, check the strength of the materials in the mounting surface. Check the material strength again after mounting as well.

**! Warning**

- Using a monitor other than this product may result in damage or bodily injury due to the monitor toppling over.
- Assemble all screws securely. Failure to do so may result in the monitor and stand falling down, potentially causing damage or bodily injury.
- This unit does not come with anchor bolts for securing it to walls, etc. Be sure you have materials on hand as appropriate for the mounting location.
- The monitor should be mounted to a wall that can adequately hold the total weight of the monitor and stand over a long period of time and which can adequately withstand earthquakes, conceivable vibrations, and other external forces.
- **Mounting On Wooden Walls**  
The weight of the unit should be borne by the wall posts or studs, and these should be reinforced if insufficiently strong. Do not install the Wall Mounting Unit on walls made of plasterboard or thin plywood. Use the commercially sold screws best suited for the wall structure and material.
- **Mounting On Concrete Walls**  
Use commercially sold wall anchors capable of supporting the weight of the monitor.
- Do not install the Wall Mounting Unit near the blower or air inlet of an air conditioner.
- Do not install the Wall Mounting Unit in a location subject to frequent vibration, impact or other external forces.
- Do not install the unit in a location where people may hang on it or lean against it.
- Do not block the ventilation holes.
- Do not install the monitor on a non-vertical wall.

**! Caution**

- Consult authorized service personnel for electrical work. Using power cords damaged during installation (i.e., exposed or severed wiring) may result in fire or electric shock.
- Conduct the work with adequate working space. Damage or bodily injury may result from working under unsuitable conditions.
- Avoid mounting this unit in areas where there is electrical wiring or water pipes, as fire or electric shock may result.

- 1 Lay the monitor on a cloth with the LCD panel facing down to prevent the LCD panel from being damaged. Loosen the stand screws on the stand support and remove the bottom plate.

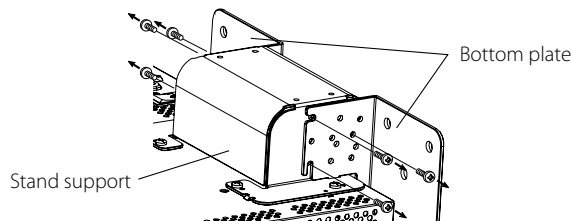

- 2 Temporarily set the stand screws in screw holes "2" and "4" on the right and left sides of the stand support.
  - Tighten the temporarily set stand screws so that they protrude from the screw holes by about 4 mm.

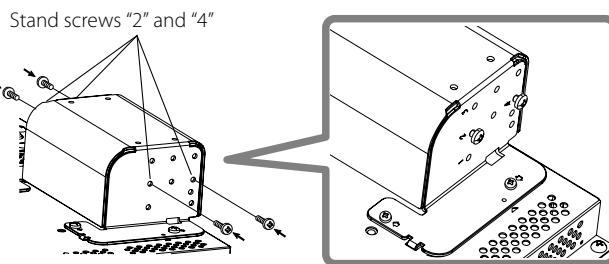

- 3 Tighten commercially available screws in the 6 holes shown in the figure below to install the monitor on the wall.

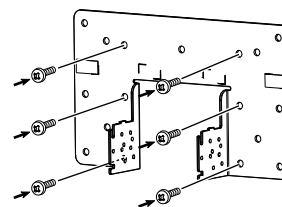

- 4 Hook the temporarily set screws on the stand support in right and left recesses "A" and "B" on the bottom plate, tighten the two stand screws in right and left screw holes "D" and finally retighten the temporarily set screws to lock the stand support and bottom plate.

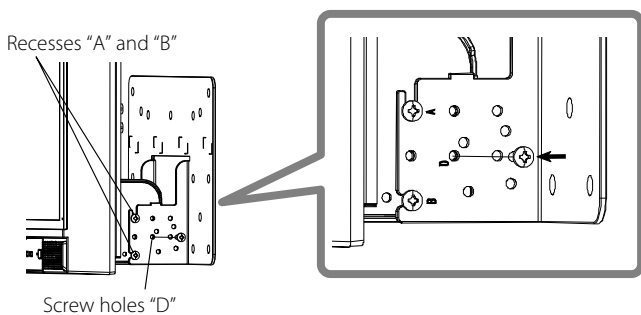

# Index of Parts and Functions

## Rear panel

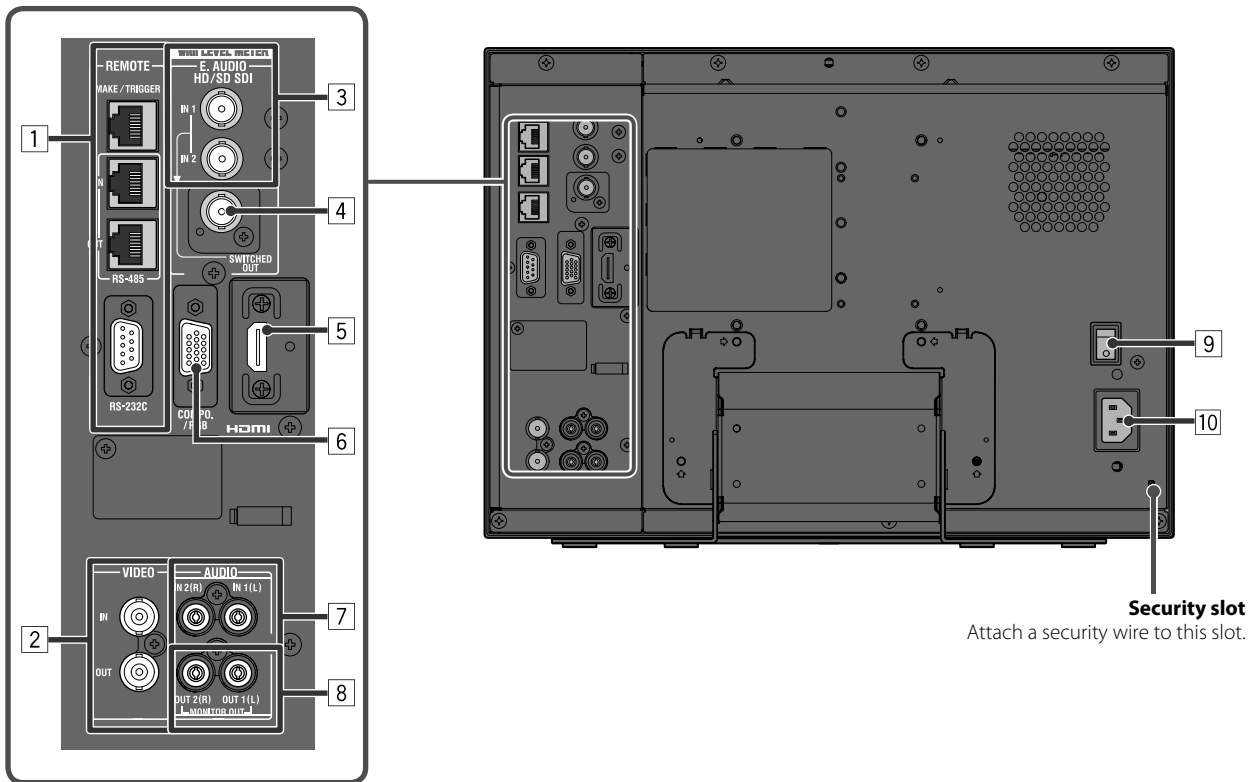

### 1 REMOTE terminal

Terminal for controlling the monitor by an external control (☞ “External Control” on page 22).

### 2 VIDEO terminals (BNC)

Input (IN) and output (OUT) terminals for the composite signals.

### 3 E. AUDIO HD/SD SDI (IN 1, IN 2) terminals (BNC)

Input terminals for the HD/SD SDI signals.

- The terminals accept also EMBEDDED AUDIO signals including up to 16 audio channels with a sampling frequency of 48 kHz.

### 4 E. AUDIO HD/SD SDI (SWITCHED OUT) terminal (BNC)

Output terminal for the HD/SD SDI signals.

- The SDI signals of the current input (SDI 1 or SDI 2) are re-clocked, then emitted.
- When an input other than SDI 1 and SDI 2 is selected, the SDI signal of the input selected last time is emitted from this terminal.
- The signals are emitted from this terminal only when the monitor is on or in “Power Save” (power save) mode (☞ “No Sync Action” on page 17).

### 5 HDMI terminal

Input terminal compatible with HDCP for the HDMI signal. (☞ page 30)

### 6 COMPO./RGB terminal (mini D-sub 15pin)

Input terminal for the analog component signal or analog RGB signal. (☞ page 30)

- Set “Component/RGB Select” (☞ page 15) appropriately for input signals.

### 7 AUDIO (IN) terminals (pin jack)

Input terminals for the analog audio signals.

- Use this terminal for the analog audio connection of the SDI. When inputting audio into this terminal, set “SDI-1 Select” or “SDI-2 Select” of the menu to “1ch+2ch”, “1ch” or “2ch” (☞ page 16).
- When you use HDMI input for the picture and analog sound for the audio signal, input analog sound into this terminal, and set “HDMI Select” of the menu to “1ch+2ch”, “1ch” or “2ch” (☞ page 16).



**8 AUDIO (MONITOR OUT) terminals (pin jack)**

Output terminals for the analog audio signal.

- The terminals emit the audio signals through the AUDIO (IN) terminal or EMBEDDED AUDIO signals through the E. AUDIO HD/SD SDI (IN 1 or IN 2) input terminal.
- The signal is output from this terminal only when the monitor is on or in "Power Save" (power save) mode (see "No Sync Action" on page 17).
- The EMBEDDED AUDIO signal...
  - is decoded into an analog signal, then emitted.
  - is emitted only when "SDI 1" or "SDI 2" is selected, and when EMBEDDED AUDIO signals come in to the E. AUDIO HD/SD SDI (IN 1 or IN 2) terminal.
- Audio signals are only output from the HDMI terminal when the signals are not protected by HDCP.
  - Even when the signals are protected by HDCP, sound is emitted from the speakers.

**9 POWER switch**

Turns AC power on or off.

- You need to press  button (see 17 on page 10) to use the monitor after turning on the POWER switch.

**10 AC IN terminal**

AC power input connector.

Connect the provided AC power cord to an AC outlet.

**CAUTION**

Do not connect the power cord until all other connections are completed.

**Note for connections**

- Before making any connections, turn off all the equipment.
- Use a cord whose plugs correctly match the terminals on this monitor and the equipment.
- Plugs should be firmly inserted; poor connections could cause noise.
- When unplugging a cord, be sure to grasp its plug and pull it out.
- DO NOT connect the power cord until all connections are complete.
- Refer also to the user manual of each piece of equipment.

# Index of Parts and Functions (cont.)

## Front panel

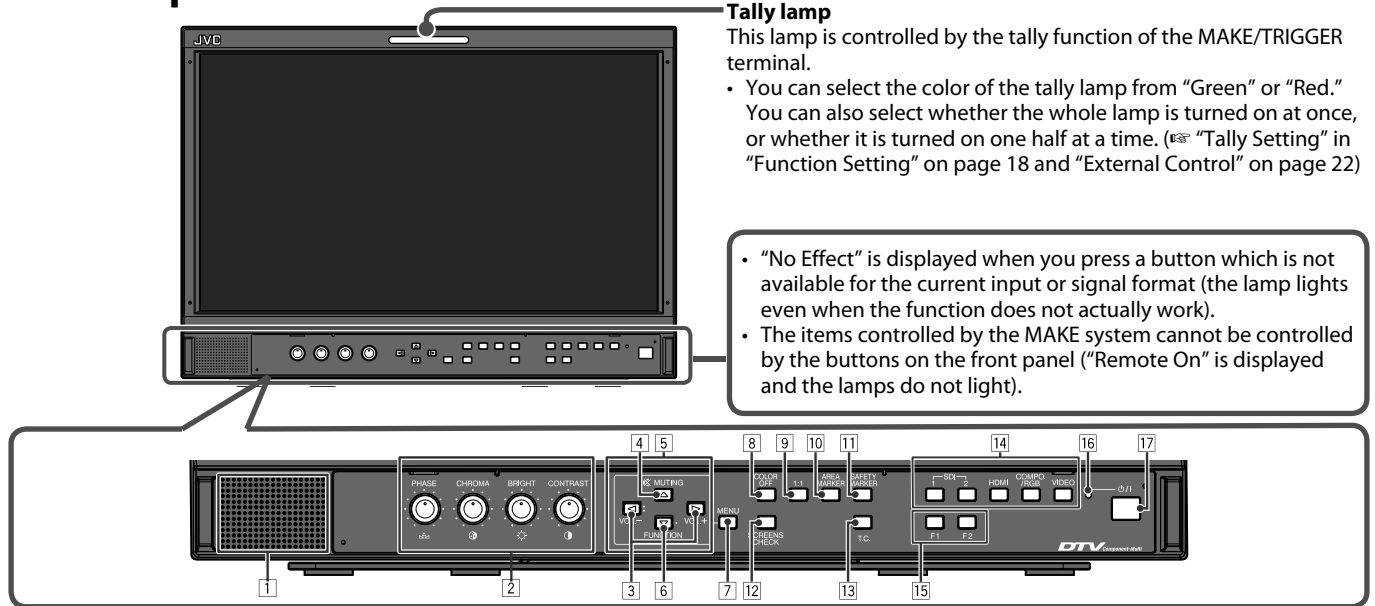

### Tally lamp

This lamp is controlled by the tally function of the MAKE/TRIGGER terminal.

- You can select the color of the tally lamp from "Green" or "Red."
- You can also select whether the whole lamp is turned on at once, or whether it is turned on one half at a time. (☞ "Tally Setting" in "Function Setting" on page 18 and "External Control" on page 22)

- "No Effect" is displayed when you press a button which is not available for the current input or signal format (the lamp lights even when the function does not actually work).
- The items controlled by the MAKE system cannot be controlled by the buttons on the front panel ("Remote On" is displayed and the lamps do not light).

### 1 Speaker (monaural)

The speaker emit the same audio signal emitted from the AUDIO (MONITOR OUT) terminals. (☞ "[8] AUDIO terminals" on page 9)

### 2 Picture adjustment knob

- PHASE:** Adjusts the picture hue
- CHROMA:** Adjusts the picture color density
- BRIGHT:** Adjusts the picture brightness
- CONTRAST:** Adjusts the picture contrast
- PHASE and CHROMA cannot be adjusted for certain signal formats.
- When "Component Phase" is set to "Disable" and an NTSC signal is input, PHASE can be adjusted (☞ page 18).

### 3 VOLUME adjustment button/EMBEDDED AUDIO setting button

Adjusts the volume when no menu screen is displayed. Selects an audio channel when EMBEDDED AUDIO signals are contained in SDI input. (☞ "Volume Adjustment/Audio Channel Selection" on page 11)

### 4 MUTING button

- Turns off the sound (Muting).
- To cancel the function, press the button again.
- Muting function is also canceled when volume is adjusted (☞ page 11).

### 5 </> / Δ / ▽ buttons

When a menu screen is displayed selects or adjusts menu items. (☞ "The operation procedure" on page 12)

### 6 FUNCTION button

Assign functions to the F1 and F2 buttons when the menu is not displayed. (☞ page 18)

### 7 MENU button

Activates/deactivates the display of the Main Menu. (☞ "The operation procedure" on page 12)

### 8 COLOR OFF button/lamp

- Displays only the luminance signal.
- This function does not work for RGB input signals.

### 9 1:1 button/lamp

- Displays the picture in the original resolution of the input signal.
- The aspect ratio of the picture may change depending on the input signal.

### 10 AREA MARKER button/lamp

- Displays/hides the area marker.
- Select the style of the area marker in "Marker" of the Main Menu (☞ page 15).
- This function works only when displaying the picture in 16:9 aspect ratio.
- This function does not work when "Area Marker" or "R-Area Marker" is set to "Off" in "Marker."

### 11 SAFETY MARKER button/lamp

- Displays/hides the safety marker.
- Adjust the area of the safety marker in "Marker" of Main Menu (☞ page 15).
- This function will not work when the picture is displayed in 1:1 aspect ratio and "SD4:3 Size" on the menu is set to "H Full".
- This function does not work when "Safety Marker" or "R-Safety Marker" is set to "Off" in "Marker."

### 12 SCREENS CHECK button/lamp

- Displays only the selected element (R, G, or B) of the video signal.
- Each time you press this button, the picture changes in the following order.

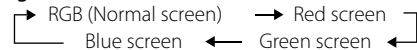

### 13 T.C. (time code) button/lamp

- Activates/deactivates the display of the time data (time code) contained in the SDI signal. (☞ "On the Information Display" on page 11)
- Select the time code type in "Information" of Set-Up Menu (☞ page 20).

### 14 INPUT SELECT buttons/lamps

- Selects an input.
- SDI 1:** E. AUDIO HD/SD SDI (IN 1) terminal
- SDI 2:** E. AUDIO HD/SD SDI (IN 2) terminal
- HDMI:** HDMI terminal
- COMPO./RGB:** COMPO./RGB terminal
- VIDEO:** VIDEO terminal
- The lamp for the selected input lights.

### 15 F1/F2 buttons/lamps

You can use the functions assigned to this button.

### 16 Power lamp

- Unlit:** The monitor is completely off (the POWER switch on the rear panel is turned off) or in Low Power Mode (☞ page 21)
- Lights in Green:** The monitor is on
- Lights in orange:** The monitor is off (on standby)
- Flashes in orange:** The monitor is in the Power Save (power save) mode (☞ "No Sync Action" on page 17)

### 17 ⏻ / I button

- Turns on and off (on standby) the monitor.
- The POWER switch is equipped on the rear panel of the monitor (☞ [9] on page 9).

# Showing Input Signals

## Volume Adjustment/Audio Channel Selection

### Volume Adjustment

- 1 When no menu screen is not displayed, press <D> (volume adjustment button).  
For SDI input the "Volume/Embedded Audio" screen appears. For any input other than SDI the "Volume" screen appears.
- 2 Press ▾ to move the cursor to "Volume".  
(This step is skipped when the "Volume/Embedded Audio" screen is not displayed.)
- 3 Press <D> to adjust the volume.
- 4 Press the MENU button to finish.  
(The "Volume" screen disappears automatically if no operations are made for 5 seconds.)

### Audio Channel Selection

Select the audio channel output from the Speaker (monaural) and AUDIO (MONITOR OUT) (OUT1(L)/OUT2(R)) terminals when an EMBEDDED AUDIO signal is input during SDI input.

- It is necessary to set the audio channel group in advance. (☞ "Embedded Audio Group" of "Audio Setting" on page 16)
  - Store the setting for each input of SDI 1 and SDI 2.
- 1 When the menu is not displayed, use the <D> buttons  
The "Volume/Embedded Audio" screen appears.
    - The "Volume/Embedded Audio" screen disappears automatically if no operations are made for about 30 seconds.
  - 2 Use the △ ▾ buttons to select the left and right channels (L ch/R ch)
  - 3 Use the <D> buttons to select the audio channel
    - Each time you press a button the audio channel changes according to the "Embedded Audio Group" setting. (☞ on page 16)
  - 4 Press the MENU button
    - The "Volume/Embedded Audio" screen disappears.

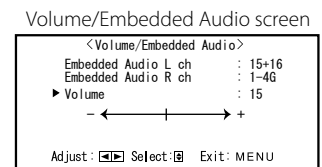
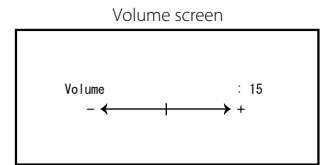

## On the Information Display

The monitor displays the information below.

- Make the setting to display/hide each information using the MENU with the exception of 5, controlled with T.C. button (☞ 13 on page 10).

### 1 Audio level meter

- You can check the conditions of the EMBEDDED AUDIO signals when "Level Meter Display" is set to "Horizontal" or "Vertical."
- Not displayed when "Level Meter Display" is set to "Off." (☞ "Audio Setting" on page 16)

### 2 Signal format

- Displayed when "Status Display" is set to "On." (☞ "Information" on page 20)
- For the contents displayed, see "Available signals" on page 29 and "On the signal format" below.

### 3 Source name assigned in "Character Setting"

- Displayed when "Source ID" is set to "On" or "Auto."
- Displayed in large letters when "Status Display" is set to "Off" or "Auto."

### 4 CRC error indication

- Displayed when "CRC Error" is set to "On." (☞ "Information" on page 20)
- A red square is displayed when an error occurs.

### 5 Time code

- Press T.C. button (☞ 13 on page 10).
- When the input signal includes no time code, "TC - - : - - : - - : - -" is displayed (☞ 13 on page 10).

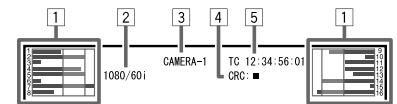

## On the Status Display

If you press the INPUT SELECT button (☞ 14 on page 10) currently lit, the status of the input signal and setting of MUTING are displayed for about 3 seconds.

- Make the setting to display/hide the status in "Status Display" of the "Information" (☞ page 20).
- When "Status Display" is set to "Auto" or "On," the status below is also displayed in the following cases:
  - When you change the input
  - When the signal condition of the current input changes
  - When you turn on the monitor
- When "Status Display" is set to "On," the signal format will remain displayed 3 seconds after the status is displayed.

### 1 Signal format

- For the contents displayed, see "Available signals" on page 29 and "On the signal format" below.

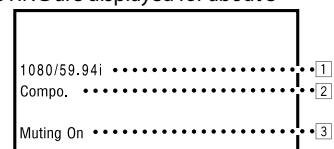

### On the signal format

The following messages appear depending on the type of input signals and their conditions.

- When a HDMI signal protected with HDCP is input** → "H" (at the end of the indication)
- When no video signal comes in** → "No Sync"
- When a noncompliant video signal comes in** → "Out of range"

### 2 Signal format of HDMI and COMPO./RGB input

### 3 Setting of "MUTING"

- Only appears when in mute mode. (☞ 4 on page 10).

# Menu Configuration

## First Time Installation

When you turn on the power and the monitor, "First Time Installation" appears. Start setting referring to the menu configuration.

For the setting items, see the pages below.

- "Language"                   ↔ "Language" on page 20
- "No Sync Action"           ↔ "Sync Function" on page 17
- "No Operation Action"   ↔ "No Operation Action" on page 17

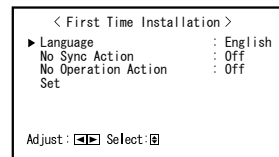

- Once the settings have been adjusted, this screen will not appear again.
- The settings can be changed afterwards in Main Menu and Set-Up Menu.

### Setting procedure

- 1 Press  $\Delta$ / $\nabla$  to move the cursor to the setting item
- 2 Press  $\triangleleft$ / $\triangleright$  to select the setting values
  - Each time you press one of these buttons, the setting value changes.
- 3 Move the cursor to "Set"
- 4 Press  $\triangleright$  to finish setting
  - When you change the settings, a confirmation message appears. Operate according to directions.

## The operation procedure

- 1 Press the MENU button to display the Main Menu

#### To display the Main Menu

➔ Press the MENU button.

#### To display the Set-Up Menu

➔ Press the  $\triangleleft$  button while holding the  $\nabla$  button.

- 2 Use the  $\Delta$ / $\nabla$  buttons to select an item and press the  $\triangleright$  button to proceed to the next screen

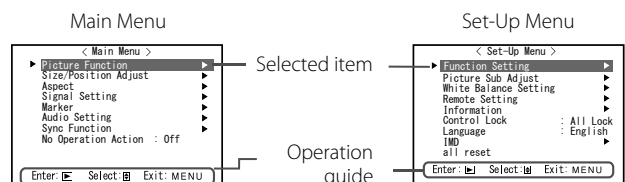

Ex.: When "Picture Function" in the Main Menu is selected



- 3 Use the  $\Delta$ / $\nabla$  buttons to select an item and press the  $\triangleright$  button to proceed to the next screen

- For some items, pressing the  $\triangleleft$ / $\triangleright$  buttons adjusts the setting.

- 4 Use the  $\Delta$ / $\nabla$  buttons to select an item and use the  $\triangleleft$ / $\triangleright$  buttons to adjust the setting

- 5 Press the MENU button to finish operations

- Press the MENU button repeatedly until the menu screen disappears.

- The menu screen disappears automatically if no operations are made for about 30 seconds.
- Inoperable menus will be grayed out.
- Some items will not be displayed on the menu depending on the selected input and signal format.

# Menu Transition Diagram

## Main Menu

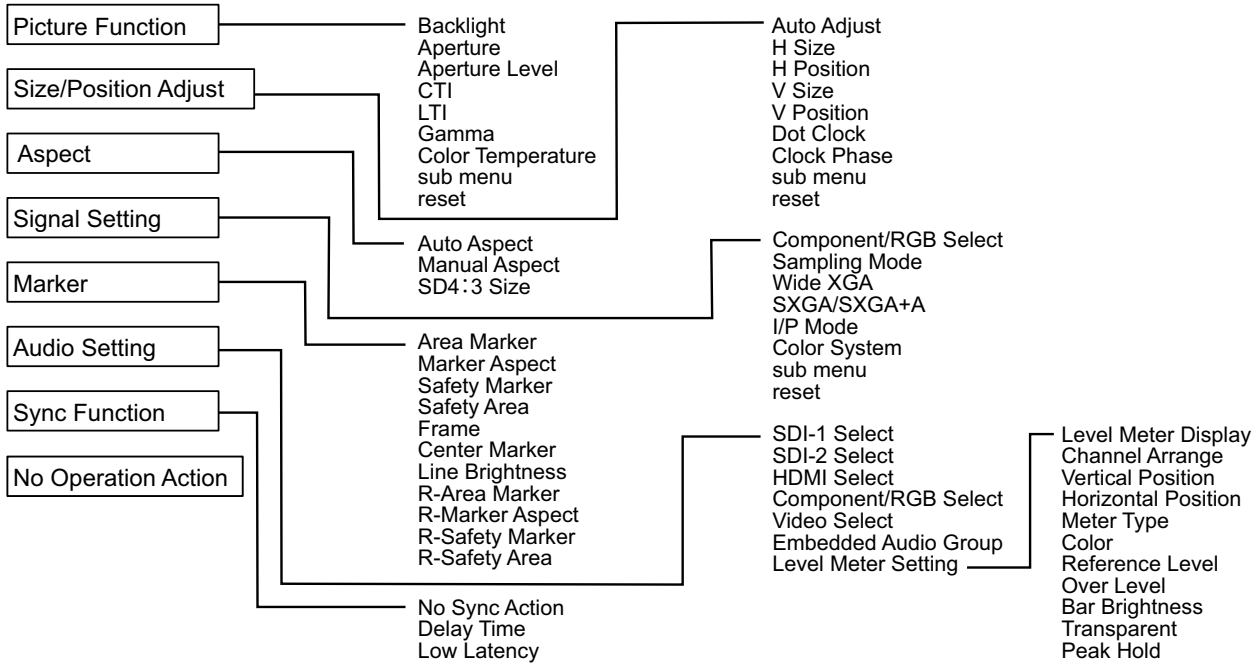

## Set-Up Menu

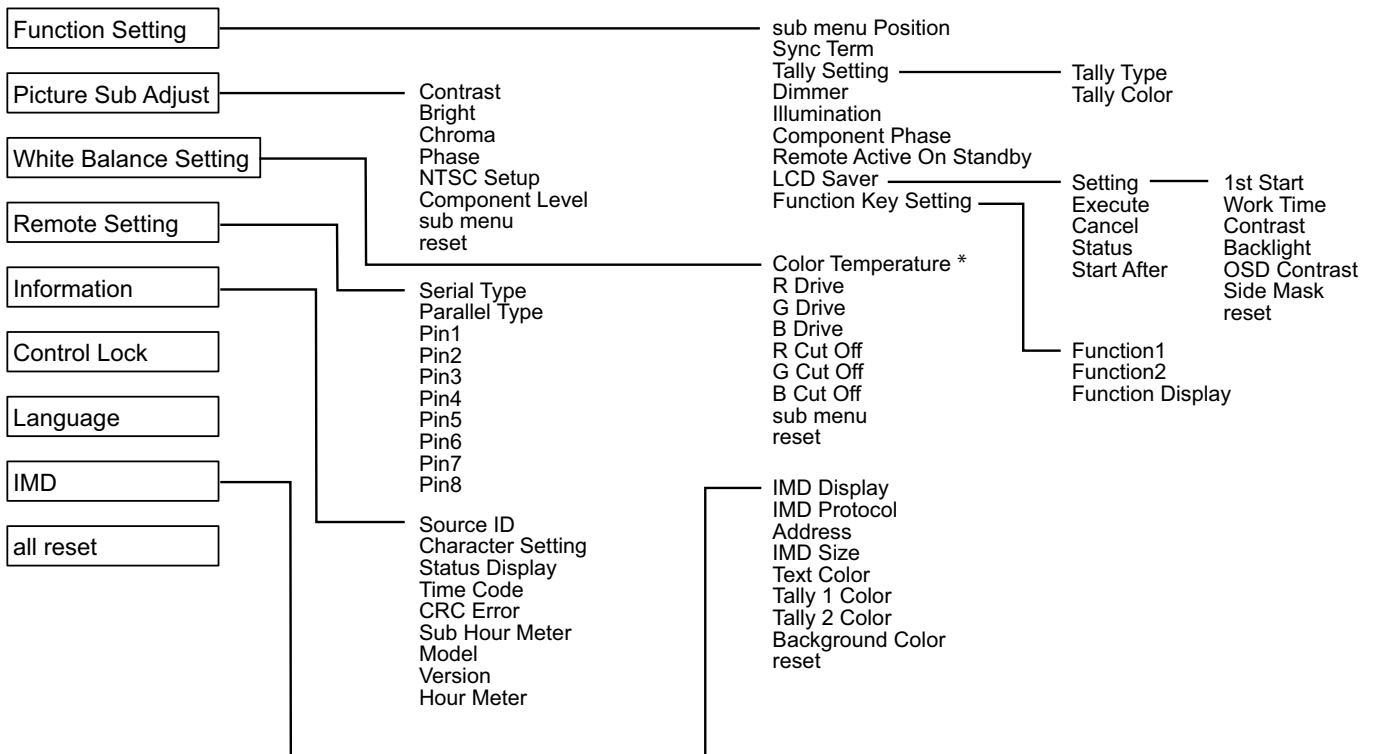

\* : "Color Temperature" is only displayed, and cannot be set/changed.

# Menu Configuration (cont.)

## Main Menu

### Picture Function

Setting for the picture quality.

Item	To do	Setting value
<b>Backlight</b>	Adjusts the brightness of the display.	-20 to +20
<b>Aperture*</b> <sup>*1</sup>	Activates/deactivates the function at the level set in "Aperture Level".	Off, On
<b>Aperture Level*</b> <sup>*1</sup>	Compensate the frequency response of the luminance signal of the video signal.	01 – 10
<b>CTI</b>	Adjust the clearness of the outlines of the chrominance signal.	Off, Normal, Hard
<b>LTI</b>	Adjust the clearness of the outlines of the luminance signal.	Off, Normal, Hard
<b>Gamma</b>	Select the Gamma correction value.	2.2 (equivalent to Y 2.2), 2.35 (equivalent to Y 2.35), 2.45 (equivalent to Y 2.45), 2.6 (equivalent to Y 2.6)
<b>Color Temperature</b>	Select the color temperature.	9300K(*), 6500K(*), User
<b>sub menu</b>	Display the sub menu which enables you to adjust the items in "Picture Function" while viewing the actual picture.	
<b>reset</b>	Restore the default settings for all the items in "Picture Function".	

\*1 Memorized for each input.

### Size/Position Adjust

Adjusts the size and position of the picture.

Item	To do	Setting value
<b>Auto Adjust</b>	Activate/deactivate the function to adjust the optimized position for each input signal.	
<b>H Size*</b> <sup>*1</sup>	Adjust the horizontal picture size.	Setting value varies depending on the signals.
<b>H Position*</b> <sup>*1</sup>	Adjust the horizontal picture position.	
<b>V Size*</b> <sup>*1</sup>	Adjust the vertical picture size.	
<b>V Position*</b> <sup>*1</sup>	Adjust the vertical picture position.	
<b>Dot Clock*</b> <sup>*1</sup>	Adjust "Dot Clock" and "Clock Phase" alternately when the displayed picture becomes unstable or streaked.	
<b>Clock Phase*</b> <sup>*1</sup>		
<b>sub menu</b>	Display the sub menu which enables you to adjust the items in "Size/Position Adjust" while viewing the actual picture.	
<b>reset</b>	Restore the default settings for all the items in "Size/Position Adjust".	

\*1 Memorized for each signal format.

### Aspect

Sets the aspect ratio of the screen for displaying videos.

Item	To do	Setting value
<b>Auto Aspect</b>	Select whether to adjust the aspect ratio (horizontal to vertical ratio of the screen) of the SD signal automatically or manually (Manual Aspect).	Off, On
<b>Manual Aspect*</b> <sup>*1</sup>	Sets the aspect ratio (horizontal to vertical ratio of the screen) of the SD signal.	16:9, 4:3
<b>SD4:3 Size*</b> <sup>*1</sup>	Selects the picture size when the input signal format is 4:3. <b>Normal</b> : Matches the vertical picture size to the number of pixels. <b>H Full</b> : Matches the horizontal picture size to the horizontal size of the screen. At this time, the top and bottom of the picture are overscanned.	Normal, H Full

\*1 Not activate when picture is displayed in the 1:1 mode.

## Signal Setting

Settings for input signals.

Item	To do	Setting value
<b>Component/RGB Select</b>	Selects the signal type you want to use for COMPO./RGB terminals.	Component, RGB
<b>Sampling Mode</b>	Analog RGB input Standard: When the input signal is VGA60 or XGA60 Wide: When the input signal is WVGA60 or WXGA60 When the input signal is other than the above, the setting value does not affect the displayed image.	Standard, Wide
<b>Wide XGA</b>	Select the analog WIDE XGA signal format.	1280*768, 1360*768
<b>SXGA/SXGA+A</b>	Select the format when the analog SXGA60 signal comes in. SXGA: Select this when the SXGA60 signal comes in. SXGA+A: Select this when the SXGA+60/SXGA+60* signal comes in. When the input signal is other than the above, the setting value does not affect the displayed image.	SXGA, SXGA+A
<b>I/P Mode*1</b>	Selects a proper mode corresponding to the input picture.	Normal, Cinema, Field
<b>Color System</b>	Select the color system. • If the picture is unstable with "Auto," select the color system according to the input signal.	Auto, NTSC, PAL, SECAM, NTSC 4.43, PAL-M, PAL-N, PAL60
<b>sub menu</b>	Display the sub menu which enables you to adjust the items in "Signal Setting" while viewing the actual picture.	
<b>reset</b>	Restore the default settings for all the items in "Signal Setting".	

\*1 When "Low Latency" on the menu is set to "On", forcefully perform I/P conversion using "Field" processing.

## Marker\*1

Settings for marker functions.

Item	To do	Setting value
<b>1/2 Area Marker</b>	Activate/deactivate the area marker and select the style of it. The setting values and features are as follows. <b>Off</b> : Deactivate the marker. <b>Line</b> : Displays the area with an outline. <b>Half</b> : The area outside the specified aspect ratio of the screen is displayed at 50% transparency. <b>Half + Line</b> : The area of the specified aspect ratio of the screen is indicated by an outline, and the area outside of that is displayed at 50% transparency.	Off, Line, Half, Half + Line
<b>Marker Aspect</b>	Select the aspect ratio of the area marker.	4:3, 14:9, 13:9, 2.35:1, 1.85:1, 1.66:1
<b>Safety Marker</b>	Activate/deactivate the safety marker and select the style of it.*2	Off, Line, Half, Half + Line
<b>Safety Area</b>	Adjust the area of the safety marker.	80% – 100%
<b>Frame*3</b>	Displays/Hides the video area.	Off, On
<b>Center Marker*3</b>	Displays/hides the marker indicating the center position of the picture.	Off, On
<b>Line Brightness</b>	Adjust the brightness of the marker.	High, Low
<b>2/2 R-Area Marker</b>	Activate/deactivate the area marker and select the style of it.*2	Off, Line, Half, Half + Line
<b>R-Marker Aspect</b>	Select the aspect ratio of the area marker.	4:3, 14:9, 13:9, 2.35:1, 1.85:1, 1.66:1
<b>R-Safety Marker</b>	Activate/deactivate the safety marker and select the style of it.*2	Off, Line, Half, Half + Line
<b>R-Safety Area</b>	Adjust the area of the safety marker.	80% – 100%

● The area marker or the safety marker is displayed by using AREA MARKER or SAFETY MARKER button, or external control.

● "R" means "REMOTE (External control)". Select either non-"R-" items or "R-" items to activate by using external control. (☞ "External Control" on page 22)

● When a picture is displayed in 4:3 aspect ratio, the safety marker for the 4:3 area is displayed.

● To display the safety marker for the area of a picture displayed in 16:9 aspect ratio, set Area Marker to "Off".

\*1 Memorized for each signal format.

\*2 The setting values are the same as that of "Area Marker".

\*3 In 1:1 mode, this display is grayed out and cannot be operated.

# Menu Configuration (cont.)

## Audio Setting

Settings for the audio signals and audio level meter signal.

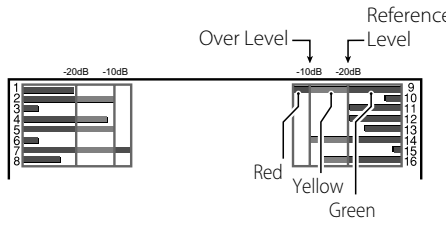
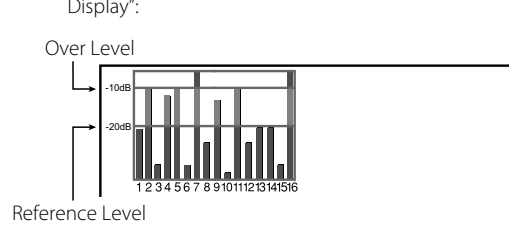
Item	To do	Setting value
SDI-1 Select SDI-2 Select	Select the input through which audio is output. <b>Auto</b> : Output digital audio prior to analog audio. <b>E.Audio</b> : Output audio from the SDI terminal. <b>1ch+2ch, 1ch, 2ch</b> : Output audio from the AUDIO IN terminal. <b>Off</b> : Does not output audio.	Auto, E.Audio, 1ch+2ch, 1ch, 2ch, Off
HDMI Select	Select the input through which audio is output. <b>Digital</b> : Output audio from the HDMI terminal. <b>1ch+2ch, 1ch, 2ch</b> : Output audio from the AUDIO IN terminal. <b>Off</b> : Does not output audio.	Digital, 1ch+2ch, 1ch, 2ch, Off
Component/RGB Select Video Select	Select the input through which audio is output. <b>1ch+2ch, 1ch, 2ch</b> : Output audio from the AUDIO IN terminal. <b>Off</b> : Does not output audio.	1ch+2ch, 1ch, 2ch, Off
Embedded Audio Group* <sup>1</sup>	Select the audio channel group of the EMBEDDED AUDIO signals. The setting values and selectable audio channels of EMBEDDED AUDIO signals are as follows. (G means GROUP) <b>1G</b> : channel(s) 1/2/3/4/1+2/3+4/1 – 4 (1G) <b>2G</b> : channel(s) 5/6/7/8/5+6/7+8/5 – 8 (2G) <b>1-2G</b> : channel(s) 1/2/3/4/5/6/7/8/1+2/3+4/5+6/7+8/1 – 4 (1G)/5 – 8 (2G)/1 – 8 (1G+2G) <b>3G</b> : channel(s) 9/10/11/12/9+10/11+12/9 – 12 (3G) <b>4G</b> : channel(s) 13/14/15/16/13+14/15+16/13+14/15+16/ <b>1-4G</b> : channel(s) 1/2/3/4/5/6/7/8/9/10/11/12/13/14/15/16/1+2/3+4/5+6/7+8/9+10/11+12/13+14/15+16/1-4(1G)/5-8(2G)/9-12(3G)/13-16(4G)/1-8(1G+2G)/9-16(3G+4G)/1-16(1-4G) <b>3-4G</b> : channel(s) 9/10/11/12/13/14/15/16/9+10/11+12/13+14/15+16/9 – 12 (3G)/13-16(4G)/9-16(3G+4G)	1G, 2G, 1-2G, 3G, 4G, 1-4G, 3-4G
Level Meter Setting* <sup>1</sup>	Specify the audio level meter display for EMBEDDED AUDIO signal. <b>Example of audio level meter display - Connection between the level meter position and channel</b> Ex: When "Horizontal" is selected for "Level Meter Display":  Ex: When "Vertical" is selected for "Level Meter Display": 	
	<ul style="list-style-type: none"> <li>The number of audio channels displayed on the level meter varies depending on the setting value of "Embedded Audio Group".</li> <li>The level meter with no audio signal input is displayed in white for "3Colors", and in gray for "White".</li> <li>Display position When "Horizontal" is selected for "Level Meter Display", the display position will be the top or bottom of the screen. When "Vertical" is selected for "Level Meter Display", the display position will be the lower right, lower left, upper left, or upper right of the screen.</li> <li>When "On" is selected for "Peak Hold", the maximum value is retained a certain period when the signal level becomes maximum.</li> </ul>	
Level Meter Display	Select the status of the level meter (display vertically, horizontally, or not displayed).	Off, Vertical, Horizontal
Channel Arrange	Select how the audio channels are displayed on the level meter.	Line, Divide
Vertical Position	Adjust the vertical level meter position.	1, 2, 3, 4
Horizontal Position	Adjust the horizontal level meter position.	Upper, Lower
Meter Type	Specify the design of the level meter.	Bar, Block
Color	Select the color of the level meter display.	3Colors (colored depending on the level), White (white only)
Reference Level	Select the standard input level indicated on the level meter.	-20dB, -18dB
Over Level	Select the input level's lower limit indicated in red for the "3Colors" display.	-10dB, -8dB, -6dB, -4dB, -2dB
Bar Brightness	Select the brightness of the level meter.	Low, High
Transparent	Adjust the transparency of the level meter display against the image.	Off, Background, All
Peak Hold	Activates/deactivates the peak hold function of the level meter.	Off, On

\*<sup>1</sup> Memorized for each input.



## Sync Function

Settings for the synchronization with signals.

Item	To do	Setting value
No Sync Action	Select the screen status when no signal is coming in.	Off, Standby, Power Save (power save mode), Gray Back (gray screen)
Delay Time	Select the period until the screen status changes as selected in "No Sync Action" after signals stop coming in.	30s, 5min, 15min
Low Latency	Activates/deactivates the function to shorten the time taken to display the picture (low latency function). <ul style="list-style-type: none"> <li>• If the picture is not displayed steadily while "On" is selected, select "Off."</li> <li>• While "On" is selected, the displayed picture may become unstable when an operation using buttons on the front panel or the menu is performed, or when the signal format changes.</li> </ul>	Off, On

- When setting "No Sync Action" to "Gray Back," the screen color changes to gray and the power consumption of the backlight is saved by half. Selecting "Power Save" (power save mode) saves more power consumption by turning off the backlight.

## No Operation Action Setting values: Off, On

Setting of the function for turning the unit off (standby) automatically when no operations are made for more than 4 hours.

Off: Does not turn off automatically

On: Turns off automatically

- When the function is turned On, a warning message will be displayed about 3 minutes before turning off automatically. When you turn on the unit with the function turned On, a message notifying that the setting is turned on will be displayed for about 30 seconds.

# Menu Configuration (cont.)

## Set-Up Menu

### Function Setting

Settings for the sub menu display, color of the tally lamp, and the intensity of the button lamps.

Item	To do	Setting value
sub menu Position	Select the contents and displaying position of "sub menu." The setting values and features are as follows. <b>Lower1</b> : Displays the current setting and adjustment bar at the lower part of the screen. <b>Upper1</b> : Displays the current setting and adjustment bar at the upper part of the screen. <b>Lower2</b> : Displays the current setting at the lower part of the screen. <b>Upper2</b> : Displays the current setting at the upper part of the screen. • The adjustment bar is not displayed for some items.	Lower1, Upper1, Lower2, Upper2
Sync Term	Specify the terminal resistant value of the RGB input synchronized signal from the COMPO./RGB terminal. • Normally, select "High". Select "Low" when the display becomes unstable due to the length of a connection cable.	Low, High
Tally Setting	Set the color and mode of the tally lamp using external control.	
Tally Type	Normal : Light up the entire tally. Half : Light up the left and right halves of the tally individually.	Normal, Half
Tally Color	Set the tally color when "Tally Type" is set to "Normal".	Green, Red
Dimmer	Select the intensity of the button lamps.	Normal, Dark
Illumination	Select whether illumination is activated/deactivated.	Off, On
Component Phase	Deactivates the function of PHASE adjustment (Picture adjustment knob and "Picture Sub Adjust" in Set-Up Menu) (☞ on page 19) except when an NTSC signal comes in.	Enable, Disable
Remote Active On Standby	Set the conditions for the power switch by external control (serial). <b>On</b> : Can power on by external control after powered OFF. <b>Off</b> : Cannot power on by external control after powered OFF.	Off, On
LCD Saver	Configure the setting for reducing damage to the LCD panel for long-time use. (☞ on page 21)	
Setting	1st Start : Set the standby time.	00h-24h
	Work Time : Set the time for performing the function.	01h-06h
	Contrast : Set the contrast reduction.	Save, Normal
	Backlight : Reduce the backlight brightness.	Save, Normal
	OSD Contrast : Set the contrast reduction of the OSD display.	Save, Normal
	Side Mask : Select whether to use the side panel. * The Side Mask function works no matter whether the LCD Saver is active or stopped.	Off, On
	reset : Restore the default settings for all the items in "LCD Saver".	
Execute	Execute the LCD Saver function.	
Cancel	Stop the LCD Saver function. ("Cancel" will be grayed out during the function stop.)	
Status	Display the LCD Saver status.	Off, Ready
Start After	Stop the LCD Saver function.	**h **min
Function Key Setting	Specify the function assigned to the F1/F2 button.	
Function1	Specify the function assigned to the F1 button.	See pages 13 to 20 for details of the functions assigned to Function 1 and Function 2.
Function2	Specify the function assigned to the F2 button.	
Function Display	Select whether to display the status of the assigned function when you press the F1/F2 button. <b>Off</b> : No status display. Perform the registration function. <b>Mode-1</b> : Display the status. Perform the registration function. <b>Mode-2</b> : Display the status. Do not perform the registration function. Perform the registration function when the status is displayed and the button is pressed again.	Off, Mode-1, Mode-2

● You can also display "Function Key Setting" Menu by pressing the ▽ button when the menu is not displayed.

● Each time you press the F1/F2 button, the setting value for the assigned function changes in order.

Ex: When "Color Temperature" is assigned

→ 9300K(\*) → 6500K(\*) → User

Each time you press the button, three setting values alternate.

## Picture Sub Adjust

Configure the standard level of image adjustment.

Item	To do	Setting value
Contrast* <sup>1</sup>	Adjust the standard level for the contrast adjusted with the CONTRAST knob on the front panel.	-20 to +20
Bright* <sup>1</sup>	Adjust the standard level for the brightness adjusted with the BRIGHT knob on the front panel.	-20 to +20
Chroma* <sup>1</sup>	Adjust the standard level for the chroma adjusted with the CHROMA knob on the front panel.	-20 to +20
Phase* <sup>1,*2</sup>	Adjust the standard level for the phase adjusted with the PHASE knob on the front panel.	-20 to +20
NTSC Setup	Select the set-up level of the input NTSC signal.	00 (compliant with 0 % set-up signal), 7.5 (compliant with 7.5 % set-up signal)
Component Level	Select the level of the analog component signal (480i and 576i only).	B75 (compliant with BetacamVTR 7.5 % set-up signal), B00 (compliant with BetacamVTR 0 % set-up signal), SMPTE (compliant with M2VTR signals)
sub menu	Display the sub menu which enables you to adjust the items in "Picture Sub Adjust" while viewing the actual picture.	
reset	Restore the default settings for all the items in "Picture Sub Adjust".	

\*<sup>1</sup> Memorized for each input.

\*<sup>2</sup> When "Component Phase" (☞ page 18) is set to "Disable," "Phase" cannot be adjusted if no NTSC signal is input.

## White Balance Setting

Display the color temperature, and adjusts the drive level and cutoff point of each color (R/G/B).

Item	To do	Setting value
Color Temperature	Select the color temperature. (Cannot be set/changed)	9300K(*), 6500K(*), User
R Drive * <sup>1</sup>	Adjust the drive level of each color (red, green, and blue).	Min – 000 – Max
G Drive	● The maximum (Max) and minimum (Min) values vary depending on the input signal or other settings.	(in 1024 grades)
B Drive		
R Cut Off * <sup>1</sup>	Adjust the cutoff point of each color (red, green, and blue).	Min – 000 – Max
G Cut Off	● The maximum (Max) and minimum (Min) values vary depending on the input signal or other settings.	(in 1024 grades)
B Cut Off		
sub menu	Display the sub menu which enables you to adjust the items in "White Balance Setting" while viewing the actual picture.	
reset	Restore the default settings for all the items in "White Balance Setting".	

\*<sup>1</sup> Memorized for each color temperature.

## Remote Setting

Settings for the external control.

Item	To do	Setting value
Serial Type	Select a terminal for external control in serial mode.	RS232C, RS485
Parallel Type	Select a control method of the MAKE/TRIGGER terminal.	Make, Trigger, Set
Pin1		
Pin2	Assign the control functions to the pins of the MAKE/TRIGGER terminal.	☞ "Display" in "Functions controlled by the Make/Trigger system" on page 23
Pin3	• Assign a function to each pin terminal by selecting "Set" in "Parallel Type" mentioned above.	
Pin4		
Pin5		
Pin6	The functions are assigned for "Pin6" – "Pin8" and you cannot change the assignment of these functions.	Tally
Pin7		Enable
Pin8		GND

# Menu Configuration (cont.)

## Information

Settings for the information display of the monitor.

Item	To do	Setting value
Source ID	Select whether the name assigned in "Character Setting" is displayed on the screen (☞ "On the Information Display" on page 11). • When "Auto" is selected, the display color synchronizes with the color of the tally lamp while the tally lamp is lit.	Off, On, Auto
Character Setting	Assign a name to each video source as you like (10 characters at maximum) (☞ Page 21). You can also enter a name using the RS-232C system.	
Status Display	Display/Hide the status of the current input and the setting of MUTING. (☞ "On the Status Display" on page 11)	Auto, Off, On
Time Code	Select the type of the TIME CODE display.	VITC*1, LTC*1, D-VITC
CRC Error	Display/Hide the CRC error when the HD SDI signal is input. (☞ "On the Information Display" on page 11)	Off, On
Sub Hour Meter	Display the hours of use (unit: hour). The usage time can be reset to 0.	
Model	Display the model name of the monitor.	
Version	Display the version of the monitor.	
Hour Meter*2	Display the total hours of use (unit: hour). This item is used for maintenance of the monitor. You cannot reset this item.	

\*1 Ancillary time code

\*2 "Hour Meter" and settings specified using the front knob are not reset.

## Control Lock\*3 Setting values: Off, Volume Lock, All Lock

Settings for disabling the buttons on the front panel.

- \*3
- The following operations are not available when "Volume Lock" is selected.
    - Picture adjustment knob
  - The "All Lock" function disables to control the buttons on the front panel. But following operations are available.
    - Turning on/off (on standby) the monitor
    - Displaying the Set-Up Menu by pressing ◀ button while holding ▽ button and turning "Control Lock" to "Off"
    - Operating the monitor by an external control
- If you try other operations, "Control Lock on!" appears on the screen.

## Language Setting values: English, Deutsch, Français, Español, Italiano, Русский

Select the displayed language for the menu, etc.

## IMD

Settings for IMD (In-monitor Display). (☞ Page 21)

Item	To do	Setting value
IMD Display	Display setting On: Displayed, Off: Not displayed	On, Off
IMD Protocol	Serial communication protocol setting Off: Supports JVC protocol, TSL V4.0: Supports TSL UMD Protocol V4.0	Off, TSL V4.0
Address	Address setting 000 to 126: Set a particular address	000 to 126
IMD Size	Text size setting Small: Small size, Large: Large size	Small, Large
Text Color	Text color setting Command: Same color as that set for communication (Command) Red, Green, Amber, Blue, Cyan, Magenta, White: Color settings	Command, Red, Green, Amber, Blue, Cyan, Magenta, White
Tally 1 Color	Tally 1 color setting Command: Same color as that set for communication (Command) Red, Green, Amber, Blue, Cyan, Magenta, White: Color settings	Command, Red, Green, Amber, Blue, Cyan, Magenta, White
Tally 2 Color	Tally 2 color setting Command: Same color as that set for communication (Command) Red, Green, Amber, Blue, Cyan, Magenta, White: Color settings	Command, Red, Green, Amber, Blue, Cyan, Magenta, White
Background Color	Display background color setting Black: Set the background of the IMD display to black Translucent: The picture on the monitor shows through the IMD display. Transparent: Set the background of the IMD display transparent.	Black, Translucent, Transparent
reset	Return the "IMD" settings to their default values	

## all reset

Restores all the settings and adjustments of the monitor to the default.

## ● Setting of "Character Setting"

- 1 Change the input to one that you want to assign a video source name for.
- 2 Select "Character Setting".
- 3 Press  $\Delta$ / $\nabla$  buttons to select the first character.
  - Each time you press  $\Delta$  button, the character changes as follows.  
Press  $\nabla$  button to reverse the order.
- 4 Press  $\triangleright$  button to move the arrow to the next space.
  - The characters entered before moving the arrow are memorized.
- 5 Repeat steps 3 and 4 (10 characters at maximum).
- 6 Press MENU button to store the name.

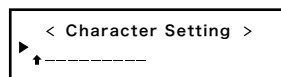

Space → 0~9 → A~Z → a~z → &()\*+,-./:<>\_

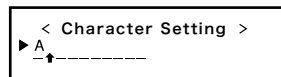

## ● How to use the LCD Saver

1. Set reduced function to perform.
2. Set both time for starting the function and time for letting it work.
3. Activate the STANDBY MODE by Execute.

### ■ Aborting the ongoing LCD Saver

Operating this apparatus may lead to aborting the OPERATION MODE.

### ■ Stopping the operation

Executing "Cancel". Turn off the power.

- Once operating the function, unless turned off the power or executed "Cancel", reduced function is automatically performed every 24 hours.

### ■ Example of setting up "1st Start" and "Work Time"

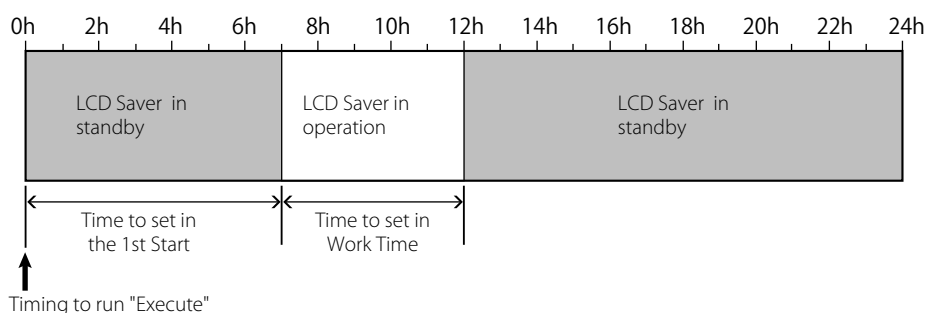

## ● IMD (In-monitor Display)

This unit supports "TSL UMD Protocol – V4.0" from Television Systems Ltd. 16 character text display and one tally on each side can be controlled. The color of both the text and the tally can be set. Using the address setting, up to 127 units can be controlled individually. To use, set the external control terminals of this unit to serial format. For details of control commands, refer to the homepage of Television Systems Ltd.

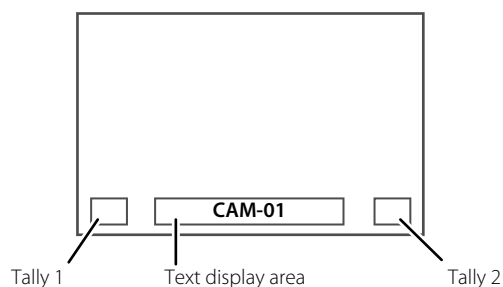

\* Example of lower screen IMD display

## ● Low Power Mode

Puts the unit into Low Power Mode 30 seconds after the monitor is switched off (standby) to further reduce power consumption.

- Low Power Mode will not activate when "Remote Active On Standby" on the Set-up Menu is set to "On".
- The power lamp will be turned off during Low Power Mode.

# External Control

## About the external control

This monitor has three external control terminals.

- **Make/Trigger terminal** (RJ-45): The following external control systems are available.
    - (1) **Make (make contact) system:**  
Controls the monitor by short-circuiting the corresponding pin terminal to the GND pin terminal, or disconnecting (opening) it.
    - (2) **Trigger (trigger) system:**  
Controls the monitor by sending the pulse signal instantaneously to the corresponding pin terminal.
  - ☞ "Using the Make/Trigger system" on the right
  - **RS-485 terminals** (RJ-45): Controls the monitor with the RS-485 system (☞ "Using the serial communication" on page 23).
  - **RS-232C terminal** (D-sub 9-pin): Controls the monitor with the RS-232C system (☞ "Using the serial communication" on page 23).
- Set the following items of "Remote Setting" in Set-Up Menu according to the external control terminal and control system (☞ "Serial Type," "Parallel Type" on page 19).

Control terminal	Control system	The settings of this unit	
		"Serial Type" setting	"Parallel Type" setting
Make/Trigger terminal	Parallel Type	Make	—
		Trigger	Make
RS-485 terminal	Serial communication	RS-485	RS485*1
		RS-232C	—
RS-232C terminal		RS232C*1	—

- \*1 For a monitor connected to a personal computer etc, select the terminal the equipment is actually connected to. For other monitors, select "RS485."
- "Make" takes precedence over other controls.
- You can use external control even when "Control Lock" is set to "Volume Lock" or "All Lock" (☞ page 20).
  - When the monitor is off (on standby), external control is not available. But certain external controls (starting/terminating communication, turning on the monitor) are available through the serial communication (☞ page 24).

### <Make/Trigger system>

You can control the monitor by a personal computer or dedicated controller\*2.

- "Using the Make/Trigger system" on the right.
- \*2 The controller is not commercially available. Consult your dealer if you need it.

### <Serial communication>

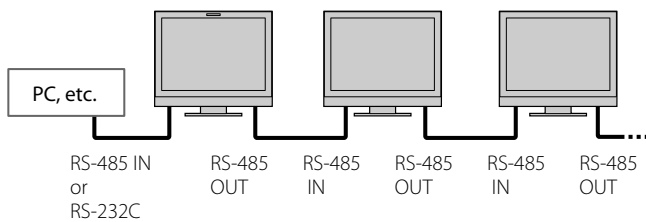

- For the details, see page 23.

## Using the Make/Trigger system

The Make/Trigger terminal is configured as follows. You can assign a function to each pin terminal in "Remote Setting" (☞ "Pin1, Pin2, Pin3, Pin4, Pin5" in "Parallel Type" on page 19).

- You cannot change the functions assigned to the pin terminals from 6th to 8th.

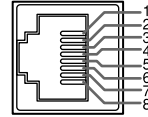

This is a female terminal.

Pin No.	Pin name
1	Pin1
2	Pin2
3	Pin3
4	Pin4
5	Pin5
6	Tally*1
7	Enable*2
8	GND

- \*1 The 6th pin terminal controls turning on or off the tally lamp (available to control even when the 7th pin terminal is invalid).
- \*2 The 7th pin terminal makes the external control valid/invalid. Keep the 7th pin short-circuited to the 8th pin to make the external control valid.

### To assign the functions to the pin terminals

For the operation procedure, see page 12.

- 1 Select "Remote Setting" on the Set-Up Menu.
- 2 Set "Parallel Type" to "Set."
- 3 Select a pin name ("Pin1" – "Pin5") for which you want to assign a function, then select the function you want to assign.  
For the selectable functions, see the table on page 23.

### Operation of the external control

- 1 Set "Parallel Type" of "Remote Setting" to "Make" or "Trigger" in the Set-Up Menu.
- 2 Keep the 7th pin terminal (Enable) short-circuited to the 8th pin terminal (GND) so that the monitor can be controlled by the external control.
- 3 When the "Make" system is selected: Operate each function by short-circuiting the corresponding pin terminal to the 8th pin terminal (GND) or opening it.  
When the "Trigger" system is selected: Operate each function by pulse control, that is short-circuiting the corresponding pin terminal to the 8th pin terminal (GND) for about 1 second and opening it.

- When changing the input with Make system, activate the pin you want after deactivating the currently used pin.
- When selecting the "Trigger" system, you can operate only one function at a time. Operate the functions one by one.

**<Functions controlled by the Make/Trigger system>**

Display	Functions to be controlled	Opening	Short-circuiting
---	No function.	---	---
Tally Color	Tally lamp color selection.*1	Green	Red
Tally Type	Tally lamp lighting method selection.	Whole	One half at a time
Tally-L(R)	Light the left half of the tally lamp in red.*2	On	Off
Tally-R(G)	Light the right half of the tally lamp in green.*2	On	Off
SDI-1	Changes the input to "SDI 1."	Invalid	Valid
SDI-2	Changes the input to "SDI 2."	Invalid	Valid
HDMI	Changes the input to "HDMI."	Invalid	Valid
Component/RGB	Changes the input to "COMPO./RGB."	Invalid	Valid
Video	Changes the input to "VIDEO."	Invalid	Valid
Area Marker	The area marker indication.	Off	On
Safety Marker	The safety marker indication.	Off	On
Center Marker	The center marker indication.	Off	On
Frame	Indication of the area of the specified aspect ratio.	Off	On
Marker Select	Selects the items of "Marker".*3	Non-"R-" items	"R-" items
Manual Aspect	Changes the aspect ratio.	4:3	16:9
1:1	Displays in 1:1 mode.	Off	On
Status	Status display.*4	☞ "On the Status Display" on page 11	
Level Meter	Audio level meter display.	*5	
Time Code	Time code display.	Off	On
Source ID	☞ "Source ID" in "Information" on page 20.	*6	
Color Off	Color off.	Color	Monochrome
Screens Check	Screens check.	*7	
I/P Mode	Change a mode according to a input picture.	*8	
Muting	Muting on/off.	Off	On
Dimmer	Change the intensity of the button lamps.	Normal	Dark

\*1 Can be controlled when "Tally Type" ("Set-Up Menu" → "Function Setting" → "Tally Setting") is set to "Normal".

\*2 Can be controlled when "Tally Type" ("Set-Up Menu" → "Function Setting" → "Tally Setting") is set to "Half".

\*3 Selects which functions in "Marker" are activated, non-"R-" items or "R-" items (☞ "Marker" on page 15).

\*4 Displays the information shown when INPUT SELECT button of the current input is pressed (☞ "On the Status Display" on page 11). While controlling with the Make system, the information is displayed only at the moment of short-circuiting.

\*5 While controlling with the Make system, the level meter is switched between displayed (short-circuiting) and hidden (opening). When "Level Meter Display" is set to "Off," the level meter is not displayed ("No Effect" appears).

While controlling with the Trigger system, the pattern of the audio channel display is switched.

\*6 While controlling with the Make system, the available set-up options will be the setting value currently selected in "Source ID" ("On" or "Auto" [short-circuiting]) and "Off" (opening). While controlling with the Trigger system, uses the same set-up option as those in the Set-Up Menu (☞ "Source ID" in "Information" on page 20).

\*7 While controlling with the Make system, the screen is switched between normal screen (opening) and blue screen (short-circuiting). While controlling with the Trigger system, the screen changes in the same way as when pressing SCREENS CHECK button (☞ 12 on page 10).

\*8 Must be controlled with the Trigger system. The mode changes in the order of "Normal" → "Cinema" → "Field." (This function cannot be controlled with the Make system.)

● You cannot assign the same function to different pin terminals.

● The Trigger system switches each function by short-circuiting the pin terminal for about 1 second and opening it.

## Using the serial communication

You can control the monitor from a personal computer etc. via the RS-485 or RS-232C terminal.

\* Consult your dealer for the details of the external control specification.

**<Communication specifications>**

Input terminal	Cable	Terminal specification	Communication specifications
RS-485	A straight LAN cable	☞ See below	Baud Rate: 4800 bps Data Bits: 8 bits Parity: No parity Stop Bits: 1 bit Flow Control: No control Communication Code: ASCII Code
RS-232C	A straight cable with a D-sub 9-pin connector (male for the monitor, female for the personal computer etc.)		

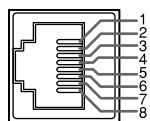
**<Specifications of the RS-485 terminal>**

This is a female terminal.

Pin No.	IN terminal signal	OUT terminal signal
1	TXD +	TXD +
2	TXD -	TXD -
3	RXD +	RXD +
4	NC	NC
5	NC	NC
6	RXD -	RXD -
7	NC	NC
8	GND	GND

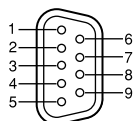
**<Specifications of the RS-232C terminal>**

This is a female terminal.

Pin No.	Signal
1	NC
2	RXD
3	TXD
4	NC
5	GND
6	NC
7	RTS
8	CTS
9	NC

● The 7th terminal and the 8th terminal are connected.

# External Control (cont.)

## <Command outline>

All commands consist of the following segments.

Header	Monitor ID	Function	Data	Cr (0Dh)
--------	------------	----------	------	----------

### On Header

“!” : Operation commands from the personal computer, etc. (☞ <Basic command list> below table).

“?” : Reference commands from the personal computer, etc.

“@” : Status returns from the monitor

To start communication, send the connection command from the personal computer etc.

To terminate the communication, send the termination command from the personal computer etc.

### Example of communication procedures

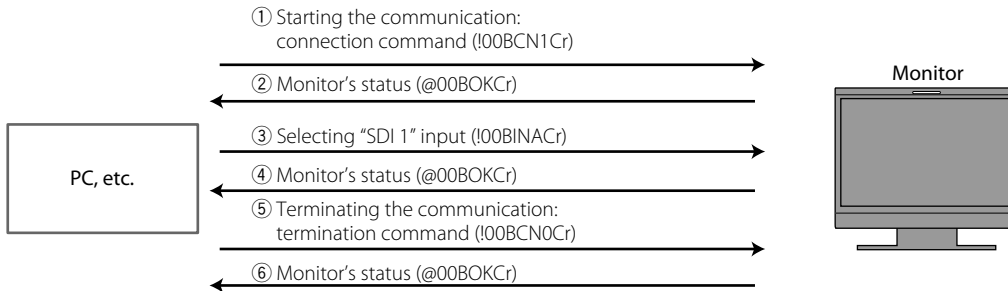

## <Basic command list>

No.	Commands	Functions	Data
1	! * **1 B C N 1 Cr	Starts communication (connection)	No data
2	! * **1 B C N 0 Cr	Terminates communication (termination)	No data
3	! * **1 B I D S E T x x*2 Cr	Assigns the control ID	01 – 99
4	! * **1 B I D R E T Cr	Initializes the control ID	No data
5	! * **1 B I D D S P x x*2 Cr	Displays/hides the ID	00: Hide, 01: Display
6	! * **1 B M E N U Cr	Displays the Main Menu/Quits the menu operation	No data
7	! * **1 B U P Cr	Moves the cursor upward (Δ)	No data
8	! * **1 B D O W N Cr	Moves the cursor downward (∇)	No data
9	! * **1 B A D J R Cr	Makes setting/adjustment (▷)	No data
10	! * **1 B A D J L Cr	Makes setting/adjustment (◁)	No data
11	! * **1 B S E T U P Cr	Displays the Set-Up Menu	No data
12	! * **1 B P W 1 Cr	Turns on the monitor	No data
13	! * **1 B P W 0 Cr	Turns off the monitor (on standby)	No data
14	! * **1 B I N A Cr	Selects "SDI 1" input	No data
15	! * **1 B I N B Cr	Selects "SDI 2" input	No data
16	! * **1 B I N C Cr	Selects "HDMI" input	No data
17	! * **1 B I N D Cr	Selects "COMPO./RGB" input	No data
18	! * **1 B I N E Cr	Selects "VIDEO" input	No data
19	! * **1 B D I S P Cr	Displays the status*3	No data
20	! * **1 B A M U T E x x*2 Cr	Turns muting on/off	00: Off, 01: On
21	! * **1 B A S P x x*2 Cr	Changes the aspect ratio	00: 4:3, 01: 16:9
22	! * **1 B V P L S Cr	Increases the volume	No data
23	! * **1 B V M N S Cr	Reduces the volume	No data
24	! * **1 B V O L x x*2 Cr	Sets the volume	00-30

● "Cr" is 0Dh.

● The commands for starting communication (connection) (No. 1), terminating communication (termination) (No. 2), and turning on the monitor (No. 13) can be used while the monitor is off (on standby).

\*1 Enter the monitor's ID for " \*\*." The initial setting of the monitor's ID is "00." When connecting several monitors, "00" is a command for controlling all monitors at once.



\*2 Enter the appropriate data to "xx."

\*3 Displays the information shown when the INPUT SELECT button currently lit is pressed (☞ "On the Status Display" on page 11).



# Troubleshooting

Solutions to common problems related to the monitor are described here. If none of the solutions presented here solve the problem, unplug the monitor and consult an authorized dealer or service center.

Symptom	Probable cause and corrective action	Page
No power supply.	<ul style="list-style-type: none"> <li>● Press the  /  button.</li> <li>● Firmly insert the AC power plug.</li> <li>● Turn on the POWER switch on the rear panel.</li> </ul>	10 9 9
No picture with the power on.	<ul style="list-style-type: none"> <li>● Select the correct input using the INPUT SELECT buttons.</li> <li>● Connect the connecting cable firmly.</li> <li>● Turn on the power of the connected component and set the output correctly.</li> <li>● Check whether the input signal format is acceptable on the monitor.</li> </ul>	10 8 — 29, 30
No sound.	<ul style="list-style-type: none"> <li>● Adjust the volume level.</li> <li>● Deactivate the muting function.</li> <li>● Connect the connecting cable firmly.</li> <li>● Turn on the power of the connected component and set the output correctly.</li> </ul>	10 10 8 —
"Out of Range" appears.	<ul style="list-style-type: none"> <li>● Check whether the input signal format is acceptable on the monitor.</li> </ul>	29, 30
"No Sync" appears.	<ul style="list-style-type: none"> <li>● Select the correct input using the INPUT SELECT buttons.</li> <li>● Connect the connecting cable firmly.</li> <li>● Turn on the power of the connected component and output video signals. Or, check whether the video output of the component (video output setting of the VCR or graphic board of the computer) is set correctly.</li> </ul>	10 8 —
Wrong color, no color.	<ul style="list-style-type: none"> <li>● Adjust each picture adjustment knob on the front panel or adjust the items of "Picture Sub Adjust" in the Set-Up Menu. Or, perform "reset" in "Picture Sub Adjust."</li> <li>● Check whether the setting of COLOR Off or SCREENS CHECK buttons are appropriate.</li> <li>● Select the proper color system ("Color System") in "Signal Setting".</li> <li>● Adjust the items of "White Balance Setting" in the Set-Up Menu. Or, perform "reset" in "White Balance Setting".</li> </ul>	10, 19 10 15 19
The picture becomes blurred.	<ul style="list-style-type: none"> <li>● Adjust the picture contrast or brightness by using the adjustment knobs on the front panel. Or, adjust "Contrast" or "Bright" of "Picture Sub Adjust" in the Set-Up Menu.</li> </ul>	10, 19
Wrong picture position, wrong picture size.  The picture may sometimes not be able to fill the whole screen depending on the signal. In this case, nothing can be done to solve the problem. Please be aware of this beforehand.	<ul style="list-style-type: none"> <li>● Check whether the setting of 1:1 is appropriate.</li> <li>● Check "Manual Aspect" and "SD4:3 Size" settings in Aspect menu.</li> <li>● Check whether the input signal format is acceptable on the monitor.</li> <li>● Adjust the picture size (H Size/V Size) or position (H Position/V Position) of "Size/Position Adjust" menu.</li> </ul>	10 14 29, 30 14
Buttons on the monitor do not work.	<ul style="list-style-type: none"> <li>● Set "Control Lock" in the Set-Up Menu to "Off."</li> <li>● You cannot use the buttons for the items controlled by the Make system. Disable the external control.</li> </ul>	20 19, 22

## ● The following are not malfunctions.

- When a still image is displayed for a long time, it may remain indistinctly on the screen after the picture has changed. Though the remaining picture will disappear after a while, there may be a case that it remains for a long period depending on the length of time the still image was displayed for. This is due to the characteristics of the LCD display and is not a malfunction.
- Red spots, blue spots and green spots on the panel surface are a normal characteristic of LCD panels, and not a problem. The LCD panel is built with very high precision technology; however, be aware that a few pixels may be missing or constantly lit.
- The following symptoms are problems only when pictures or sounds are not played back normally.
  - A slight electric shock occurs when you touch the LCD panel.
  - The top and/or rear panel of the monitor becomes hot.
  - The monitor emits a cracking noise.
  - The monitor emits a mechanical noise.

# Troubleshooting (cont.)

## Self-check program

This monitor has a self-check function, which allows it to detect malfunctions and alert you. This makes troubleshooting easier. Whenever a problem occurs, one or some of the INPUT SELECT (COMPO./RGB, VIDEO) lamps will flash. If this happens, follow the steps below and contact your dealer to resolve the problem.

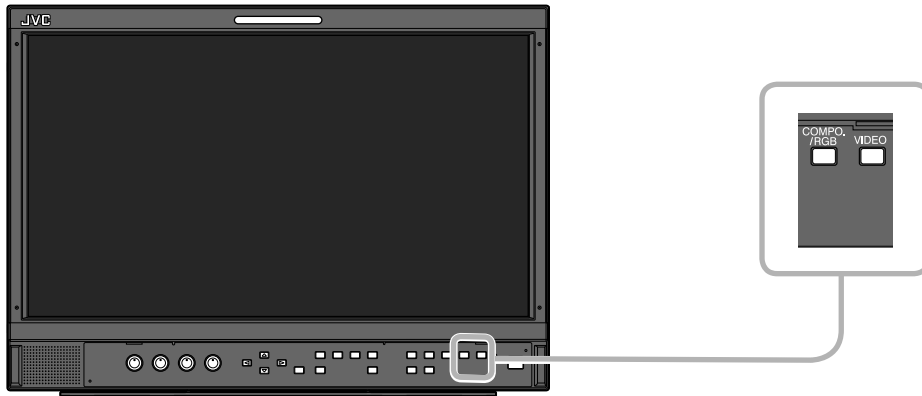

**When the screen goes blank, and one or some of the INPUT SELECT (COMPO./RGB, VIDEO) lamps on the front control panel start flashing...**

- 1** Check which lamps are flashing.
  - 2** Press  / I button to turn off (on standby) the monitor.
  - 3** Turn off the POWER switch on the rear panel.
  - 4** Disconnect the AC power cord from the AC outlet.
  - 5** Contact your dealer with the information about which lamps were flashing.
- If you turn on the monitor soon after turning it off (or after a short-term power failure), the INPUT SELECT lamps may flash and no image may be displayed.  
When this happens, turn off power and wait at least 10 seconds before turning on the monitor again.  
If the INPUT SELECT lamps do not flash, you can use the monitor as normal.
  - The self-check function does not work when the setup menu "Remote Active On Standby" is set to "Off" and you turn off the monitor (put the monitor in standby).

# Specifications

EN

## General

Model name	DT-E15L4	
Type	Multi format LCD monitor	
Screen size	Type 15 wide format	
Aspect ratio	16:9	
Horizontal/vertical frequency (computer signal)	H: 31.469 kHz – 75.000 kHz V: 49.990 Hz – 75.062 Hz * Some signals within this frequency range may not be displayed ("Out of range" is displayed).	
Compliant video signal format	☞ "Available signals" on page 29	
Format	HD SDI: BTA S-004C, SMPTE292M SD SDI: ITU-R BT.656: 525/625 SMPTE259M: 525 EMBEDDED AUDIO: SMPTE299M, SMPTE272M	
Audio output	Internal speaker: 1.0 W	
Operating conditions	Operating temperature: 5°C – 35°C Operating humidity: 20% – 80% (non-condensing) (Slightly variable depending on ambient conditions for installation.)	
Power requirements	AC 120 V / AC 220 – 240 V, 50 Hz/60 Hz	
Rated current	0.6 A (AC 120 V) 0.35 A (AC 220 – 240 V)	
External dimensions (excluding protruding parts)	with the stand	without the stand
	Width: 373 mm	373 mm
	Height: 270.1 mm	265 mm
	Depth: 181 mm	99 mm
Weight	5.9 kg (with the stand)	4.3 kg (without the stand)
Accessories	AC power cord x 2	

## LCD panel

Type	15" wide, active matrix TFT
Effective screen size	Width: 344 mm Height: 194 mm Diagonal: 395 mm
Number of pixels displayed	1366 x 768
Number of colors displayed	16.70 million
Viewing angle (TYP.)	170° (Horizontally), 160° (Vertically)
Brightness (TYP.)	300 cd/m <sup>2</sup>
Contrast ratio (TYP.)	500:1

## Input/output terminals

Video	VIDEO	Input/output of composite signal: 1 line, BNC connector x 2, 1 V (p-p), 75 Ω * The input (IN) and output (OUT) terminals are bridge-connected (auto termination).
	HDMI	HDMI signal input (compatible with HDCP): HDMI connector x 1
	COMPO./RGB (R, G, B, HS, VS or Y, Pb/B-Y, Pr/R-Y)	Analog Component signal input/Analog RGB signal input: 1 Line, mini D-SUB 15pin x1 Y: 1 V(p-p), 75 Ω(with sync) G, B/PB/B-Y, R/PR/R-Y: 0.7 V (p-p), 75 Ω HS, VS: 0.3 V (p-p) to 5 V (p-p) * For HS and VS, change the Low/High terminals manually.
	E. AUDIO HD/SD SDI (IN 1)	Digital signal input (compatible with EMBEDDED AUDIO signals): auto detection, 2 line, BNC connector x 2
	E. AUDIO HD/SD SDI (IN 2)	
	E. AUDIO HD/SD SDI (SWITCHED OUT)	Digital signal output (compatible with EMBEDDED AUDIO signals): 1 line switched out, BNC connector x 1
Audio	AUDIO (IN)	Analog audio signal input: 1 line, RCA connector x 2, 500 mV (rms), high impedance
	AUDIO (MONITOR OUT)	Analog audio signal output: 1 line, RCA connector x 2, 500 mV (rms)
External control	REMOTE (MAKE/TRIGGER)	☞ "Using the Make/Trigger system" on page 22
	REMOTE (RS-485)	☞ "Using the serial communication" on page 23
	REMOTE (RS-232C)	

# Specifications (cont.)

## Dimensions Unit: mm

### DT-E15L4

<Front view>

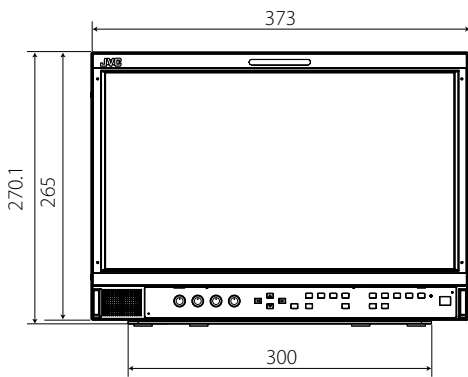

<Side view>

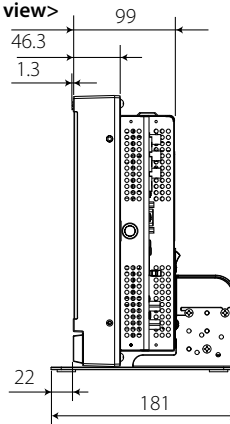

<Rear view>

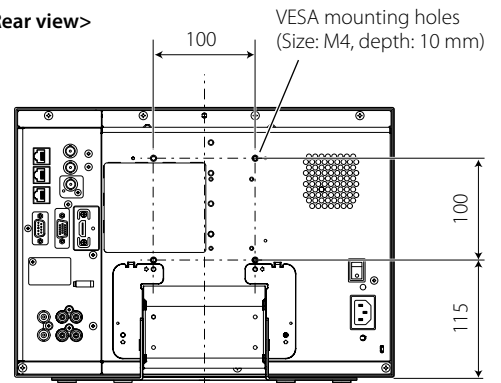

### To install the monitor on a shelf

<Top view>

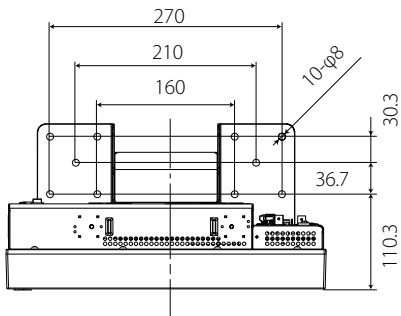

<Side view>

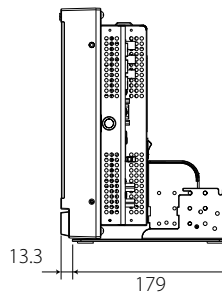

### To install the monitor on a wall

<Rear view>

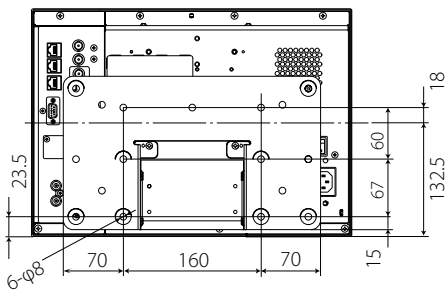

<Side view>

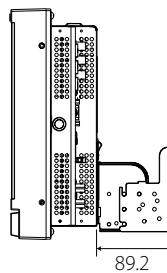

## Available signals

The following signals are available for this monitor.

### Video signals

No.	Signal name	Signal format shown in the status display (see page 11)*1	Input terminal				
			VIDEO	analog COMPO.	analog RGB	E.AUDIO *2 HD/SD SDI	HDMI
1	NTSC	NTSC	√	—	—	—	—
2	NTSC 4.43	N 4.43	√	—	—	—	—
3	PAL-M	PAL-M	√	—	—	—	—
4	PAL60	PAL60	√	—	—	—	—
5	PAL	PAL	√	—	—	—	—
6	PAL-N	PAL-N	√	—	—	—	—
7	SECAM	SECAM	√	—	—	—	—
8	B/W50	B/W50	√	—	—	—	—
9	B/W60	B/W60	√	—	—	—	—
10	480/60i	480/60i	—	√	—	—	√
11	480/59.94i	480/59.94i	—	√	—	√	√
12	576/50i	576/50i	—	√	—	√	√
13	480/60p	480/60p	—	√	—	—	√
14	480/59.94p	480/60p	—	√	—	—	√
15	576/50p	576/50p	—	√	—	—	√
16	640*480/60p	640*480/60p	—	—	√	—	√
17	640*480/59.94p	640*480/60p	—	—	√	—	√
18	720/60p	720/60p	—	√	—	√	√
19	720/59.94p	720/59.94p	—	√	—	√	√
20	720/50p	720/50p	—	√	—	√	√
21	720/30p	720/30p	—	—	—	√	—
22	720/29.97p	720/29.97p	—	—	—	√	—
23	720/25p	720/25p	—	—	—	√	—
24	720/24p	720/24p	—	—	—	√	—
25	720/23.98p	720/23.98p	—	—	—	√	—
26	1080/60i	1080/60i	—	√	—	√	√
27	1080/59.94i	1080/59.94i	—	√	—	√	√
28	1035/60i	1035/60i	—	—	—	√	√
29	1035/59.94i	1035/59.94i	—	—	—	√	√
30	1080/50i	1080/50i	—	√	—	√	√
31	1080/60p	1080/60p	—	√	√	—	√
32	1080/59.94p	1080/60p	—	√	√	—	√
33	1080/50p	1080/50p	—	√	√	—	√
34	1080/30p	1080/30p	—	—	—	√	√
35	1080/29.97p	1080/29.97p	—	—	—	√	√
36	1080/25p	1080/25p	—	—	—	√	√
37	1080/24p	1080/24p	—	—	—	√	√
38	1080/23.98p	1080/23.98p	—	—	—	√	√
39	1080/30PsF	1080/30psf	—	—	—	√*3	—
40	1080/29.97PsF	1080/29.97psf	—	—	—	√*4	—
41	1080/25PsF	1080/25psf	—	—	—	√*5	—
42	1080/24PsF	1080/24psf	—	—	—	√	—
43	1080/23.98PsF	1080/23.98psf	—	—	—	√	—

√: Acceptable

—: Not acceptable

\*1 For signal formats other than E.Audio HD/SD SDI input, \*\*/59.94, \*\*/29.97, and \*\*/23.98 will be displayed as \*\*/60, \*\*/30, and \*\*/24 respectively.

\*2 Compatible with EMBEDDED AUDIO signals.

\*3 The signal is recognized as 1080/60i, and the status is displayed as "1080/60i."

\*4 The signal is recognized as 1080/59.94i, and the status is displayed as "1080/59.94i."

\*5 The signal is recognized as 1080/50i, and the status is displayed as "1080/50i."

- HDMI, the HDMI logo, and High-Definition Multimedia Interface are trademarks or registered trademarks of HDMI Licensing LLC in the United States and other countries.
- HDCP stands for High-bandwidth Digital Content Protection, a copy protection technology of high reliability licensed by Digital Content Protection, LLC.

# Specifications (cont.)

## Computer signals (preset)

Analog RGB input (COMP./RGB terminals) and DVI input (HDMI terminal):

No.	Signal name	Resolution		Frequency		Scan system
		Horizontal	Vertical	Horizontal (kHz)	Vertical (Hz)	
1	VGA60	640	480	31.5	59.9	Non-interlace
2	WVGA60	852	480	31.5	59.9	Non-interlace
3	SVGA60	800	600	37.9	60.3	Non-interlace
4	XGA60	1024	768	48.4	60.0	Non-interlace
5	WXGA (1280)	1280	768	47.8	60.0	Non-interlace
6	WXGA+60 *1	1440	900	55.9	60.0	Non-interlace
7	SXGA60 *1	1280	1024	64.0	60.0	Non-interlace
8	UXGA60 *1	1600	1200	75.0	60.0	Non-interlace
9	WUXGA60 *1	1920	1200	74.0	60.0	Non-interlace
10	1080/60p *1	1920	1080	67.5	60.0	Non-interlace
11	1080/50p *1	1920	1080	56.3	50.0	Non-interlace
12	US TEXT *2, *5	720	400	31.5	70.1	Non-interlace
13	WXGA(1360)	1360	768	47.7	60.0	Non-interlace
14	SXGA+/60A *1, *3	1400	1050	64.0	60.0	Non-interlace
15	SXGA+/60B *1, *4	1400	1050	65.2	60.0	Non-interlace
16	MAC13 *5	640	480	35.0	66.7	Non-interlace
17	MAC16 *5	832	624	49.7	74.5	Non-interlace
18	MAC19 *5	1024	768	60.2	74.9	Non-interlace
19	MAC21 *5	1152	870	68.7	75.1	Non-interlace

\*1 No. 6, 7, 8, 9, 10, 11, 14 and No. 15 signals come in, thin lines will become obscured because their signal resolution is higher than the screen resolution.

\*2 The signal is recognized as VGA400/70, and the status is displayed as "VGA400/70".

\*3 The signal is recognized as SXGA+60, and the status is displayed as "SXGA+60".

\*4 The signal is recognized as SXGA+60\*, and the status is displayed as "SXGA+60\*".

\*5 Only supports analog RGB input.

- Non-preset signals may not be displayed normally even if the frequency is within the acceptable range.
- When a preset signal comes in, the signal format is shown on the status display. When a non-preset signal comes in, "Out Of Range" appears.

## Specification of the HDMI terminal

Connect it to the HDMI output terminal of a video device.

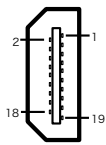

Pin No.	Input signal	Pin No.	Input signal	Pin No.	Input signal
1	T.M.D.S Data 2+	8	T.M.D.S Data 0 shield	15	SCL
2	T.M.D.S Data 2 shield	9	T.M.D.S Data 0-	16	SDA
3	T.M.D.S Data 2-	10	T.M.D.S Clock+	17	DDC/CEC GND
4	T.M.D.S Data 1+	11	T.M.D.S Clock shield	18	+5 V Power
5	T.M.D.S Data 1 shield	12	T.M.D.S Clock-	19	Hot Plug Detect
6	T.M.D.S Data 1-	13	Spare (not connected)		
7	T.M.D.S Data 0+	14	Spare (not connected)		

## Specification of the mini D-SUB15pin terminal

Connect it to the mini D-SUB15pin output terminal of a video device.

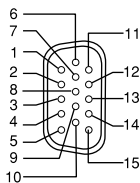

Pin No.	Input signal	Pin No.	Input signal	Pin No.	Input signal
1	Red video signal	7	Green video signal return	13	Horizontal synchronization signal
2	Green video signal	8	Blue video signal return	14	Vertical synchronization signal
3	Blue video signal	9	Not connected	15	I2C clock
4	Not connected	10	Ground		
5	Ground	11	Not connected		
6	Red video signal return	12	I2C data		

## Notice on transportation

This monitor is precision equipment and needs dedicated packing material for transportation. Never use any packing material supplied from sources other than JVC or JVC-authorized dealers.

- For easy understanding, pictures and illustrations are shown by being emphasized, omitted or composed, and may be slightly different from actual products.
- Design and specifications are subject to change without notice.
- All company names and product names mentioned herein are used for identification purposes only, and may be the trademarks or registered trademarks of their respective companies.

# MEMO

EN

