

# JVC

## REMOTE CONTROL UNIT

# RM-HP790DU RM-HP790DE

## INSTRUCTIONS

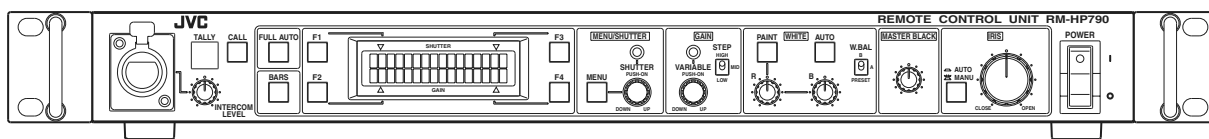

### For Customer Use:

Enter below the Serial No. which is located on the body.  
Retain this information for future reference.

Model No. RM-HP790DU

Serial No. \_\_\_\_\_

### Please read the following before getting started:

Thank you for purchasing this JVC product.  
Before operating this unit, please read the instructions  
carefully to ensure the best possible performance.

In this manual, each model number is described without the last letter  
(U/E) which means the shipping destination. (U: for USA and Canada,  
E: for Europe)

Only "U" models (RM-HP790DU) have been evaluated by UL.

## Introduction

### FOR USA

These are general **IMPORTANT SAFEGUARDS** and certain items may not apply to all appliances.

### IMPORTANT SAFEGUARDS

1. Read all of these instructions.
2. Save these instructions for later use.
3. All warnings on the product and in the operating instructions should be adhered to.
4. Unplug this appliance system from the wall outlet before cleaning. Do not use liquid cleaners or aerosol cleaners. Use a damp cloth for cleaning.
5. Do not use attachments not recommended by the appliance manufacturer as they may cause hazards.
6. Do not use this appliance near water - for example, near a bathtub, washbowl, kitchen sink, or laundry tub, in a wet basement, or near a swimming pool, etc.
7. Do not place this appliance on an unstable cart, stand, or table. The appliance may fall, causing serious injury to a child or adult, and serious damage to the appliance. Use only with a cart or stand recommended by the manufacturer, or sold with the appliance. Wall or shelf mounting should follow the manufacturer's instructions, and should use a mounting kit approved by the manufacturer. An appliance and cart combination should be moved with care. Quick stops, excessive force, and uneven surfaces may cause the appliance and cart combination to overturn.
8. Slots and openings in the cabinet and the back or bottom are provided for ventilation, and to insure reliable operation of the appliance and to protect it from overheating, these openings must not be blocked or covered. The openings should never be blocked by placing the appliance on a bed, sofa, rug, or other similar surface. This appliance should never be placed near or over a radiator or heat register. This appliance should not be placed in a built-in installation such as a bookcase unless proper ventilation is provided.
9. This appliance should be operated only from the type of power source indicated on the marking label. If you are not sure of the type of power supplied to your home, consult your dealer or local power company. For appliance designed to operate from battery power, refer to the operating instructions.
10. This appliance system is equipped with a 3-wire grounding type plug (a plug having a third (grounding pin)). This plug will only fit into a grounding-type power outlet. This is a safety feature. If you are unable to insert the plug into the outlet, contact your electrician to replace your obsolete outlet. Do not defeat the safety purpose of the grounding plug.
11. For added protection for this product during a lightning storm, or when it is left unattended and unused for long periods of time, unplug it from the wall outlet and disconnect the antenna or cable system. This will prevent damage to the product due to lightning and power-line surges.
12. Do not allow anything to rest on the power cord. Do not locate this appliance where the cord will be abused by persons walking on it.
13. Follow all warnings and instructions marked on the appliance.
14. Do not overload wall outlets and extension cords as this can result in fire or electric shock.
15. Never push objects of any kind into this appliance through cabinet slots as they may touch dangerous voltage points or short out parts that could result in a fire or electric shock. Never spill liquid of any kind on the appliance.
16. Do not attempt to service this appliance yourself as opening or removing covers may expose you to dangerous voltage or other hazards. Refer all servicing to qualified service personnel.
17. Unplug this appliance from the wall outlet and refer servicing to qualified service personnel under the following conditions:
  - a. When the power cord or plug is damaged or frayed.
  - b. If liquid has been spilled into the appliance.
  - c. If the appliance has been exposed to rain or water.
  - d. If the appliance does not operate normally by following the operating instructions. Adjust only those controls that are covered by the operating instructions as improper adjustment of other controls may result in damage and will often require extensive work by a qualified technician to restore the appliance to normal operation.
  - e. If the appliance has been dropped or the cabinet has been damaged.
  - f. When the appliance exhibits a distinct change in performance - this indicates a need for service.
18. When replacement parts are required, be sure the service technician has used replacement parts specified by the manufacturer that have the same characteristics as the original part. Unauthorized substitutions may result in fire, electric shock, or other hazards.
19. Upon completion of any service or repairs to this appliance, ask the service technician to perform routine safety checks to determine that the appliance is in safe operating condition.

PORTABLE CART WARNING  
(symbol provided by RETAC)



S3125A

# Safety Precautions

## FOR USA AND CANADA



### CAUTION

RISK OF ELECTRIC SHOCK  
DO NOT OPEN



#### CAUTION:

TO REDUCE THE RISK OF ELECTRIC SHOCK,  
DO NOT REMOVE COVER (OR BACK).  
NO USER-SERVICEABLE PARTS INSIDE. REFER  
SERVICING TO QUALIFIED SERVICE PERSONNEL.



The lightning flash with arrowhead symbol, within an equilateral triangle is intended to alert the user to the presence of uninsulated "dangerous voltage" within the product's enclosure that may be of sufficient magnitude to constitute a risk of electric shock to persons.



The exclamation point within an equilateral triangle is intended to alert the user to the presence of important operating and maintenance (servicing) instructions in the literature accompanying the appliance.

#### INFORMATION:

This equipment has been tested and found to comply with the limits for a Class A digital device, pursuant to Part 15 of the FCC Rules.

These limits are designed to provide reasonable protection against harmful interference when the equipment is operated in a commercial environment. This equipment generates, uses, and can radiate radio frequency energy and, if not installed and used in accordance with the instruction manual, may cause harmful interference to radio communications. Operation of this equipment in a residential area is likely to cause harmful interference in which case the user will be required to correct the interference at his own expense.

#### CAUTION:

CHANGES OR MODIFICATIONS NOT APPROVED BY JVC COULD VOID USER'S AUTHORITY TO OPERATE THE EQUIPMENT.

THIS DEVICE COMPLIES WITH PART 15 OF THE FCC RULES. OPERATION IS SUBJECT TO THE FOLLOWING TWO CONDITIONS: (1) THIS DEVICE MAY NOT CAUSE HARMFUL INTERFERENCE, AND (2) THIS DEVICE MUST ACCEPT ANY INTERFERENCE RECEIVED, INCLUDING INTERFERENCE THAT MAY CAUSE UNDESIRE OPERATION.

## POUR CANADA



### ATTENTION

RISQUE D'ELECTROCUTION  
NE PAS OUVRIR



#### ATTENTION:

POUR EVITER TOUT RISQUE D'ELECTROCUTION  
NE PAS OUVRIR LE BOITIER. AUCUNE PIECE  
INTERIEURE N'EST A REGLER PAR L'UTILISATEUR.  
SE REFERER A UN AGENT QUALIFIE EN CAS DE  
PROBLEME.



Le symbole de l'éclair à l'intérieur d'un triangle équilatéral est destiné à alerter l'utilisateur sur la présence d'une "tension dangereuse" non isolée dans le boîtier du produit. Cette tension est suffisante pour provoquer l'électrocution de personnes.



Le point d'exclamation à l'intérieur d'un triangle équilatéral est destiné à alerter l'utilisateur sur la présence d'opérations d'entretien importantes au sujet desquelles des renseignements se trouvent dans le manuel d'instructions.

Ces symboles ne sont utilisés qu'aux Etats-Unis.

#### INFORMATION (FOR CANADA) RENSEIGNEMENT (POUR CANADA)

This Class A digital apparatus complies with Canadian ICES-003.

Cet appareil numérique de la Class A est conforme à la norme NMB-003 du Canada.

#### WARNING:

TO REDUCE THE RISK OF FIRE OR ELECTRIC SHOCK,  
DO NOT EXPOSE THIS APPLIANCE TO RAIN OR MOISTURE.

#### CAUTION:

This unit should be used with 120V AC only. (RM-HP790DU)  
To prevent electric shocks and fire hazards, do NOT use  
any other power source.

#### AVERTISSEMENT:

POUR EVITER LES RISQUES D'INCENDIE OU  
D'ELECTROCUTION, NE PAS EXPOSER L'APPAREIL  
A L'HUMIDITE OU A LA PLUIE.

#### ATTENTION:

Ce magnétoscope ne doit être utilisé que sur du courant  
direct en 120V.  
Afin d'éviter tout risque d'incendie ou d'électrocution, ne  
pas utiliser d'autres sources d'alimentation électrique.

#### NOTE:

The rating plate and the safety caution are on the top of the unit.

#### REMARQUE:

La plaque d'identification (numéro de série) se trouve sur  
le panneau arrière de l'appareil.

#### CAUTION:

To prevent electric shock, do not open the cabinet.  
No user serviceable parts inside. Refer servicing to  
qualified service personnel.

Due to design modifications, data given in this instruction  
book are subject to possible change without prior notice.

The apparatus shall not be exposed to dripping or  
splashing and that no objects filled with liquids, such as  
vases, shall be placed close to the apparatus.

## Safety Precautions (continued)

**IMPORTANT (In the United Kingdom)  
Mains Supply (AC 230 V)  
WARNING - THIS APPARATUS  
MUST BE EARTHED**

The wires in this mains lead are coloured in accordance with the following code;  
GREEN-and-YELLOW : EARTH  
BLUE : NEUTRAL

BROWN : LIVE

As the colours of the wires in the mains lead of this apparatus may not correspond with the coloured markings identifying the terminals in your plug, proceed as follows.

The wire which is coloured GREEN-AND-YELLOW must be connected to the terminal in the plug which is marked with the letter E or by the safety earth symbol or coloured GREEN or GREEN-AND-YELLOW.

The wire which is coloured BLUE must be connected to the terminal which is marked with the letter N or which is coloured BLACK. The wire which is coloured BROWN must be connected to the terminal which is marked with the letter L or coloured RED.

**POWER SYSTEM  
Connection to the mains supply**

This unit operates on voltage of 230 V AC, 50 Hz (RM-HP790DE).

**Caution for AC Power Cord  
FOR YOUR SAFETY PLEASE READ THE  
FOLLOWING TEXT CAREFULLY.**

Appropriate AC Power Cord must be used in each local area.

**FOR CONTINENTAL EUROPE, ETC.**  
Not to be used in the U.K.

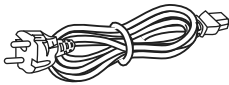

**FOR EUROPE**

This equipment is in conformity with the provisions and protection requirements of the corresponding European Directives. This equipment is designed for professional video appliances and can be used in the following environments:

- Controlled EMC environment (for example, purpose-built broad-casting or recording studio), and rural outdoors environments.

In order to keep the best performance and furthermore for electromagnetic compatibility we recommend to use cables not exceeding the following lengths:

Port	Cable	Length
[CAMERA CABLE]	Shielded Cable	5 m
[REMOTE]	Shielded Cable	5 m
[HD/SD SDI INPUT]	Shielded Cable	10 m
[HD/SD SDI OUTPUT]	Shielded Cable	10 m
[COMPOSITE VIDEO]	Shielded Cable	10 m
[VIDEO OUTPUT] ([Y/G], [Pb/B], [Pr/R])	Shielded Cable	10 m
[GENLOCK INPUT]	Shielded Cable	10 m
[AUX VIDEO INPUT]	Shielded Cable	10 m
Intercom connector (CANNON)	Shielded Cable	1.5 m
[INTERCOM] ([H], [C], [G])	Shielded Cable	3 m
[TALLY] ([PVW], [PGM], [C])	Unshielded Cable	3 m
[AC~IN]	Unshielded Cable	2.5 m

The inrush current of this apparatus is 7.4A.

**Caution:**

Where there are strong electromagnetic waves or magnetism, for example near a radio or TV transmitter, transformer, motor, etc., the picture and the sound may be disturbed. In such case, please keep the apparatus away from the sources of the disturbance.

**WARNING—THIS APPARATUS  
MUST BE EARTHED**

Changes or modifications not approved by JVC could void the user's authority to operate the equipment. This unit is designed for professional use only.

**CAUTION:**

RED color indications on the operation panel are provided but they are not safety related, RED color indications :

- (1) For Tally Indicator
- (2) For Calling Indicator

**WARNING**

This is a Class A product. In a domestic environment this product may cause radio interference in which case the user may be required to take adequate measures.

**WARNING**

For PLUGGABLE EQUIPMENT, the socket outlet shall be installed near the equipment and shall be easily accessible.

**Dear Customer,**

This apparatus is in conformance with the valid European directives and standards regarding electromagnetic compatibility and electrical safety.

European representative of Victor Company of Japan, Limited is:

JVC Technical Services Europe GmbH  
Postfach 10 05 04  
61145 Friedberg  
Germany

**FOR USE IN CHINA ONLY****《电子信息产品污染控制管理办法》规定的表示内容****关于环保使用期限**

- 此图标表示了中国《电子信息产品污染控制管理办法》规定的环保使用期限。只要用户在使用本产品时遵守注意事项中的各项规定，从制造日期开始到此图标标出的期限为止（环保使用期限）既不会污染环境也不会产生对人体有害的物质。

环保使用期限

**关于产品中的有毒、有害物质**

零件名称	有毒或有害物质、元素					
	铅 (Pb)	水银 (Hg)	镉 (Cd)	六价铬 (Cr6+)	多溴联苯 (PBB)	多溴二苯醚 (PBDE)
线路板组件	x	o	o	x	o	o
机箱	x	o	o	x	o	o
液晶显示屏	x	x	o	x	o	o
其他附件	x	o	o	x	o	o

o : 此零件中的每个均匀材料所含有的有毒、有害物质的量在SJ/T 11363-2006标准规定的范围之内。  
x : 此零件中至少有一种均匀材料含有有毒、有害物质的量超过了SJ/T 11363-2006标准的规定。

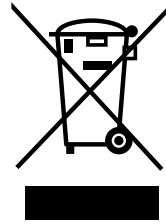
**Information for Users on Disposal of Old Equipment [European Union]****Attention:**

This symbol is only valid in the European Union.

This symbol indicates that the electrical and electronic equipment should not be disposed as general household waste at its end-of-life. Instead, the product should be handed over to the applicable collection point for the recycling of electrical and electronic equipment for proper treatment, recovery and recycling in accordance with your national legislation.

By disposing of this product correctly, you will help to conserve natural resources and will help prevent potential negative effects on the environment and human health which could otherwise be caused by inappropriate waste handling of this product. For more information about collection point and recycling of this product, please contact your local municipal office, your household waste disposal service or the shop where you purchased the product. Penalties may be applicable for incorrect disposal of this waste, in accordance with national legislation.

**(Business users)**

If you wish to dispose of this product, please visit our web page <http://www.jvc.eu> to obtain information about the take-back of the product.

**[Other Countries outside the European Union]**

If you wish to dispose of this product, please do so in accordance with applicable national legislation or other rules in your country for the treatment of old electrical and electronic equipment.

# Safety Precautions (continued)

## Place of storage and use

- Avoid storing or using the unit in the following places. Failure to do so may lead to malfunction or breakdown.
  - Extremely hot or cold places beyond the allowable temperature for operation (-5 °C to 40 °C)
  - Humid or dry places beyond the allowable humidity range for operation (30 % to 80 %)
  - Places that generate strong magnetic fields, e.g. transformers or motors
  - Places near devices that generate electric waves, e.g. transceivers or mobile phones
  - Dusty or sandy places
  - Places exposed to strong vibration
  - Places prone to condensation, such as by a window
  - Places that generate radiation, X-rays or corrosive gases

## Handling the unit

- Do not stack units on top of each other. Doing so may cause malfunction or failure due to overheating or noise, or lead to fire.
- Do not block the ventilation openings. If the openings are blocked, heat will build up inside the unit, leading to fire. Do not use the unit in a vertical position or when it is placed upside down or face up.
- Do not place any objects on the unit. Placing a heavy object such as a TV monitor or a large object that protrudes over the edge of the unit on top of the unit may cause it to overbalance and topple over or fall off and cause injury.
- Do not climb on the unit. Doing so may cause the unit to topple over or be damaged. Particular attention should be paid to small children.
- Do not place anything containing water on the unit (such as a vase, plant pot, glass, cosmetics or chemicals). If water gets inside the unit, it may lead to fire or electric shock.
- Do not insert foreign objects into the unit. If any metal object or flammable item gets into the unit through the ventilation openings, etc., it may lead to fire or electric shock.

## Maintaining the unit

- Wipe the unit with a soft cloth. Do not use thinner or benzene as this may cause the surface to dissolve or tarnish. For stubborn stains, wipe first with a water-diluted neutral detergent and then wipe dry.

## Moving the unit

- Disconnect the cords before moving the unit. Before moving the unit, turn off the power and be sure to unplug the power cord from the electric outlet. Failure to do so may result in damage to the cord or lead to fire or electric shock.
- Wrap the unit in protective packing to prevent physical shocks.
- Handle the unit with care. Do not subject it to vibration or physical shocks.

## Saving power

- For safety reasons and to save energy, unplug the power cord when the unit is not in use for long periods.

## Power cord

- Do not use the power cord supplied with the unit on other devices.
- Do not place heavy items on the power cord or trap the cord under the unit. Doing so may result in damage to the cord or lead to fire or electric shock.
- Be sure to use the power cord supplied with the unit. Using a different type or damaged cord may lead to fire or electric shock.

# Sicherheitsvorkehrungen (für Deutschland)

## FÜR DEUTSCHLAND

Dieses Gerät entspricht den Bestimmungen und Schutzanforderungen der anwendbaren EU-Richtlinien. Dieses Gerät wurde für professionelle Videoanwendungen entwickelt und kann in den folgenden Umgebungen eingesetzt werden:

- Kontrollierte EMC-Umgebung (z.B. spezielles Rundfunkstudium Aufnahme-Studio) sowie ländliche Außenumgebungen.

Zu Erzielung der bestmöglichen Leistung und außerdem zum Zwecke der elektromagnetischen Kompatibilität empfehlen wir die Verwendung von Kabeln, die folgende Längswerte nicht überschreiten:

Anschluss	Kabel	Kabellänge (max.)
[CAMERA CABLE]	Geschirmtes Kabel	5 m
[REMOTE]	Geschirmtes Kabel	5 m
[HD/SD SDI INPUT]	Geschirmtes Kabel	10 m
[HD/SD SDI OUTPUT]	Geschirmtes Kabel	10 m
[COMPOSITE VIDEO]	Geschirmtes Kabel	10 m
[VIDEO OUTPUT] ([Y/G], [PB/B], [PR/R])	Geschirmtes Kabel	10 m
[GENLOCK INPUT]	Geschirmtes Kabel	10 m
[AUX VIDEO INPUT]	Geschirmtes Kabel	10 m
Intercom connector (CANNON)	Geschirmtes Kabel	1,5 m
[INTERCOM] ([H], [C], [G])	Geschirmtes Kabel	3 m
[TALLY] ([PVW], [PGM], [C])	Ungeschirmtes Kabel	3 m
[AC~IN]	Ungeschirmtes Kabel	2,5 m

Die Inrush-Strömung dieses Apparates ist 7,4A.

### Achtung:

In Bereichen, in denen ein hohes Maß an elektromagnetischer oder magnetischer Strahlung vorhanden ist – etwa in der Nähe eines Radio- oder TVSenders, eines Transformators, Motors usw. –, können Bild- und Tonstörungen auftreten. Bitte stellen Sie das Gerät in solchen Fällen in größerer Entfernung zur Störquelle auf.

## SPANNUNGSVERSORGUNG

Anschluss am Netz  
Die Betriebsspannung für dieses Gerät beträgt AC230 V, 50 Hz (RM-HP790DE)

## ACHTUNG:

**UM DER GEFAHR VON BRÄNDEN UND ELEKTRISCHEN SCHLÄGEN VORZUBEUGEN, DARF DIESES GERÄT WEDER DEM REGEN NOCH HOHER FEUCHTIGKEIT AUSGESETZT WERDEN.**

## ACHTUNG

Um elektrische Schläge zu vermeiden, das Gehäuse nie öffnen. Im Innern befinden sich keine Teile, die vom Benutzer gewartet werden können. Überlassen Sie die Wartung qualifiziertem Service-Personal.

## WARNUNG

Bei dem Gerät handelt es sich um ein Klasse-A-Produkt. In Haushaltsumgebungen kann ein solches Produkt Funkstörungen verursachen. In einem solchen Fall muss der Benutzer geeignete Maßnahmen ergreifen.

## WARNUNG

Übermäßiger Schalldruck von Ohrhörern bzw. Kopfhörern kann einen Hörverlust bewirken. Eine Einstellung des Ausgangs auf Maximalwerte erhöht die Ausgangsspannung am Ohrhoerer- bzw. Kopfhoererausgang und damit auch den Schalldruckpegel.

## Sehr geehrter Kunde, sehr geehrte Kundin,

dieses Gerät stimmt mit den gültigen europäischen Richtlinien und Normen bezüglich elektromagnetischer Verträglichkeit und elektrischer Sicherheit überein. Die europäische Vertretung für die Victor Company of Japan, Limited ist:  
JVC Technical Services Europe GmbH  
Postfach 10 05 04  
61145 Friedberg  
Deutschland

# Sicherheitsvorkehrungen (Fortsetzung)

### Benutzerinformationen zur Entsorgung alter Geräte [Europäische Union]

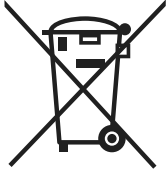

#### Hinweis:

Dieses Symbol ist nur in der Europäischen Union gültig.

Dieses Symbol zeigt an, dass das elektrische bzw. elektronische Gerät nicht als normaler Haushaltsabfall entsorgt werden soll. Stattdessen sollte das Produkt zur fachgerechten Entsorgung, Weiterverwendung und Wiederverwertung in Übereinstimmung mit der Landesgesetzgebung einer entsprechenden Sammelstelle für das Recycling elektrischer und elektronischer Geräte zugeführt werden.

Die korrekte Entsorgung dieses Produkts dient dem Umweltschutz und verhindert mögliche Schäden für die Umwelt und die menschliche Gesundheit, welche durch unsachgemäße Behandlung des Produkts auftreten können. Weitere Informationen zu Sammelstellen und dem Recycling dieses Produkts erhalten Sie bei Ihrer Gemeindeverwaltung, Ihrem örtlichen Entsorgungsunternehmen oder in dem Geschäft, in dem Sie das Produkt gekauft haben.

Für die nicht fachgerechte Entsorgung dieses Abfalls können gemäß der Landesgesetzgebung Strafen ausgesprochen werden.

#### (Geschäftskunden)

Wenn Sie dieses Produkt entsorgen möchten, besuchen Sie bitte unsere Webseite <http://www.jvc.eu>, um Informationen zur Rücknahme des Produkts zu erhalten.

#### [Andere Länder außerhalb der Europäischen Union]

Wenn Sie dieses Produkt entsorgen möchten, halten Sie sich dabei bitte an die entsprechenden Landesgesetze und andere Regelungen in Ihrem Land zur Behandlung elektrischer und elektronischer Geräte.

Erklärung zum Rauschen (für die Bundesrepublik Deutschland) :  
Maschinenlärminformations-Verordnung 3. GPSGV, 06.01.2004: Der höchste Schalldruckpegel beträgt 70 dB (A) oder weniger gemäß EN ISO 7779

#### Hinweis zum Netzanschlußkabel

**Zu Ihrer Sicherheit lesen Sie bitte das folgende sorgfältig.**

Verwenden Sie ausschließlich ein in Ihrem Land zulässiges Netzkabel.

#### Für Kontinentaleuropa

Nicht für den Gebrauch in Großbritannien.

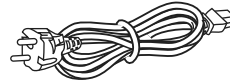

Das Gerat ist nicht fuer die Benutzung am Bildschirmarbeitsplatz gemaess BildscharbV vorgesehen.



---

## WICHTIGE SICHERHEITSHINWEISE

1. Alle Warnungen auf dem Produkt sowie in der Betriebsanleitung sind unbedingt zu beachten.
2. Ziehen Sie den Netzstecker dieses Systems aus der Steckdose, bevor Sie das Gerät reinigen. Benutzen Sie keine Flüssigreiniger und keine Sprühreiniger. Verwenden Sie zum Reinigen lediglich ein leicht angefeuchtetes Tuch.
3. Benutzen Sie keine Zubehörteile, die nicht vom Hersteller empfohlen werden; diese können Gefahren und Risiken verursachen.
4. Benutzen Sie das Gerät nicht in der Nähe von Wasser und sonstigen Flüssigkeiten - beispielsweise nicht in der Nähe von Badewannen, Handwaschbecken, Spülen, Waschbecken, nicht in feuchten Kellern, nicht in der Nähe von Schwimmbecken, und so weiter.
5. Stellen Sie das Gerät nicht auf instabile Wagen, Ständer oder Tische. Das Gerät kann herunterfallen, ernsthafte Verletzungen bei Kindern und Erwachsenen hervorrufen und auch selbst schwer beschädigt werden. Benutzen Sie ausschließlich Wagen oder Ständer, die vom Hersteller empfohlen oder mit dem Gerät verkauft wurden. Bei der Aufstellung im Regal halten Sie sich an die Anweisungen des Herstellers. Zusätzlich sollten Sie einen vom Hersteller zugelassenen Montagesatz verwenden. Eine Kombination aus Gerät und Wagen sollte grundsätzlich mit großer Sorgfalt bewegt werden. Schnelle Stopps, übermäßiger Krafteinsatz und unebener Untergrund können zum Umkippen der Gerät-Wagen-Kombination führen.
6. Schlitze und Öffnungen im Gehäuse sowie an Rückwand und Unterseite dienen der Belüftung des Gerätes und sorgen dafür, dass das Gerät zuverlässig arbeiten und sich nicht überhitzen kann. Daher dürfen Sie diese Öffnungen auf keinen Fall blockieren oder abdecken. Die Öffnungen können beispielsweise blockiert werden, wenn Sie das Gerät auf ein Bett, ein Sofa, einen Teppich oder einen ähnlichen Untergrund stellen. Dies darf auf keinen Fall geschehen. Das Gerät sollte niemals in der Nähe oder über Heizgeräten oder anderen Geräten, die Wärme abstrahlen, aufgestellt werden. Geschlossene Aufstellungsorte wie Bücherregale eignen sich nur dann zur Aufstellung des Gerätes, wenn eine ordnungsgemäße Belüftung jederzeit gewährleistet ist.
7. Das Gerät ist mit einem Schutzkontaktstecker (einem Stecker mit Erdungsbügeln an beiden Seiten) ausgestattet. Dieser Stecker lässt sich nur in eine geerdete Schutzkontaktsteckdose einstecken. Dies dient Ihrer Sicherheit. Falls sich der Stecker nicht problemlos in die Steckdose einstecken lassen sollte, lassen Sie die (veraltete) Steckdose von einem Elektriker austauschen. Versuchen Sie niemals, die Sicherheit, die Ihnen ein Schutzkontaktstecker bietet, auf irgendeine Weise außer Kraft zu setzen.
8. Um das Gerät während eines Gewitters oder für einen längeren unbeaufsichtigten Zeitraum zu schützen, ziehen Sie den Netzstecker aus der Steckdose, und trennen Sie die Antenne oder das Kabelsystem ab. Dadurch vermeiden Sie Produktschäden, die als Folge eines Blitzeinschlags oder Stromstosses auftreten können.
9. Sorgen Sie dafür, dass nichts auf dem Netzkabel zu liegen kommt. Platzieren Sie das Gerät nicht an Stellen, an denen Personen auf das Kabel treten und es beschädigen können.
10. Beachten Sie alle Warnungen und Anleitungen, die auf dem Gerät vermerkt sind.
11. Überlasten Sie niemals Steckdosen oder Verlängerungskabel: Dies kann leicht zu Stromschlägen und Bränden führen.
12. Stecken Sie niemals Gegenstände gleich welcher Art durch die Gehäuseöffnungen in das Gerät; dabei können Hochspannung führende Teile berührt und Kurzschlüsse verursacht werden: Es besteht akute Brand- und Stromschlaggefahr. Lassen Sie niemals Flüssigkeiten gleich welcher Art auf oder in das Gerät gelangen.
13. Unter folgenden Bedingungen ziehen Sie den Netzstecker und lassen das Gerät von einem qualifizierten Techniker überprüfen und reparieren:
  - a. Wenn das Netzkabel oder der Netzstecker beschädigt ist; auch kleinste Beschädigungen können große Auswirkungen haben.
  - b. Falls Flüssigkeit auf oder in das Gerät gelangt sein sollte.
  - c. Wenn das Gerät mit Regen oder Wasser in Berührung gekommen ist.
  - d. Wenn das Gerät nicht normal funktioniert, obwohl die Betriebsanleitung befolgt wurde. Passen Sie nur die Steuerungen an, die in der Betriebsanleitung vermerkt sind. Die Anpassung anderer Steuerungen kann ansonsten zu Schäden führen, die dann sehr aufwändig von einem qualifizierten Techniker repariert werden müssen, damit das Gerät wieder einwandfrei funktioniert.
  - e. Falls das Gerät fallen gelassen oder das Gehäuse beschädigt wurde.
  - f. Falls sich die Leistung des Gerätes spürbar ändern sollte - in diesem Fall muss das Gerät dringend überprüft und/oder repariert werden.

# Sicherheitsvorkehrungen (Fortsetzung)

## ACHTUNG

- 1) Nehmen Sie nicht die Frontabdeckung ab.
- 2) Falls sich die Frontabdeckung lösen sollte, setzen Sie sie sofort wieder auf.

## Lager- und Verwendungsort:

- Vermeiden Sie, den Gerät an folgenden Plätzen zu lagern oder zu verwenden. Eine Missachtung kann zu einem Fehler oder einer Störung führen.
  - Extrem heiße oder kalte Plätze, die außerhalb der zulässigen Betriebstemperatur liegen (-5 °C bis 40 °C)
  - Feuchte oder trockene Plätze, die außerhalb der zulässigen Feuchtigkeit für den Betrieb liegen (30% bis 80%)
  - Plätze, an denen starke Magnetfelder erzeugt werden, beispielsweise Transformatoren oder Motoren
  - Plätze in der Nähe von Geräten, die elektrische Wellen erzeugen, beispielsweise Sender-Empfänger oder Handys
  - Staubige oder sandige Plätze
  - Plätze, die starken Erschütterungen ausgesetzt sind
  - Plätze, die zu Kondensationsbildung neigen, beispielsweise ein Fenster
  - Plätze, die Strahlung, Röntgenstrahlen oder ätzende Gase erzeugen

## Handhabung des Geräten:

- Stapeln Sie Gerät nicht aufeinander. Dies kann zu erhöhter Geräusentwicklung und aufgrund von Überhitzung zu Fehlfunktionen oder zum Totalausfall der Geräte bis hin zu Bränden führen.
- Blockieren Sie nicht die Belüftungsschlitze. Sind die Öffnungen blockiert, bildet sich im Inneren des Geräten Hitze, wodurch ein Brand entstehen kann. Benutzen Sie den Gerät nicht in vertikaler Position, nicht auf dem Kopf stehend, nicht mit der Front nach oben.
- Legen Sie keine Gegenstände auf dem Gerät ab. Wenn Sie einen schweren Gegenstand, beispielsweise einen Fernsehbildschirm oder einen großen Gegenstand, der über die Kante des Geräten hinausragt, auf den Gerät stellen, kann dieser aus dem Gleichgewicht geraten. Dadurch besteht die Gefahr, dass der Gerät kippt oder auf den Boden fällt und Verletzungen verursacht.
- Steigen Sie nicht auf den Gerät. Der Gerät könnte umfallen oder beschädigt werden. Achten Sie besonders auf kleine Kinder.

- Stellen Sie keine wasserhaltigen Gegenstände auf dem Gerät ab (beispielsweise Vase, Blumentopf, Gläser, Kosmetika oder Chemikalien). Tritt Wasser in das Innere des Geräten ein, kann dies einen Brand oder einen Kurzschluss verursachen.
- Stecken Sie keine Fremdkörper in den Gerät. Dringen metallische oder brennbare Gegenstände durch die Belüftungsschlitze o.ä. in den Gerät ein, kann dies einen Brand oder einen Kurzschluss verursachen.

## Pflege des Geräten

- Wischen Sie den Gerät mit einem weichen Tuch ab. Verwenden Sie keine Verdüner oder Benzol. Dies könnte dazu führen, dass die Oberfläche zersetzt oder matt wird. Im Fall von hartnäckigen Flecken, wischen Sie diese zunächst mit einem neutralen und mit Wasser verdünnten Reiniger ab, und wischen Sie die Fläche dann trocken.

## Transport des Geräten

- Trennen Sie vor dem Transport des Geräten alle Kabel ab. Schalten Sie den Gerät vor dem Transport aus und stellen Sie sicher, dass der Netzstecker aus der Steckdose entfernt wurde. Wird dies nicht beachtet, kann dies zu Beschädigungen am Kabel, einem Brand oder einem Stromschlag führen.
- Achten Sie bei der Verpackung darauf, dass der Gerät vor Stößen geschützt ist.
- Gehen Sie vorsichtig mit dem Gerät um. Setzen Sie ihn keinesfalls Erschütterungen oder Stößen aus.

## Netzkabel

- Verwenden Sie das mit dem Gerät gelieferte Netzkabel ausschließlich für dieses Gerät.
- Stellen Sie keine schweren Gegenstände auf das Netzkabel und vermeiden Sie, dass das Netzkabel unter dem Gerät eingeklemmt wird. Wird dies nicht beachtet, kann dies zu Beschädigungen am Kabel, einem Brand oder einem Stromschlag führen.
- Benutzen Sie grundsätzlich das mit dem Gerät gelieferte Netzkabel. Die Verwendung eines anderen oder beschädigten Kabels kann zu Stromschlägen und Bränden führen.

## Einbau des RM-HP790DE in einem EIA-Rack mit Montageklammern:

- 1) Entfernen Sie 4 Schrauben und 4 Füße vom Boden des RM-HP790DE.
- 2) Befestigen Sie diese mit M5-Schrauben am Rack. Diese Schrauben sind im Lieferumfang des RM-HP790DE enthalten.

## Achtung

- Stellen Sie keinerlei Gegenstände auf den RM-HP790DE, wenn dieser in einem Rack montiert ist. Dies kann durch Ungleichgewicht zum Herunterfallen des Gerätes führen und Verletzungen oder Schäden verursachen.
- Werden zwei oder mehrere Geräte in dem Rack eingebaut, achten Sie darauf, dass der Abstand mindestens die Größe eines Gerätes beträgt.
- Bauen Sie den RM-HP790DE nicht in ein Rack ein, wenn die Umgebungstemperatur 40°C oder mehr beträgt.
- Wenn Sie das Gerät in einem Rack montieren, halten Sie einen Abstand von mindestens 15 cm zwischen Rack und der Rückwand des Gerätes ein.
- Vor dem Einbau in das Rack ist sicherzustellen, dass das Rack sicher und vor dem Umfallen geschützt ist.

Beachten Sie im Fall eines Einbaus oder Wartung dieses Gerätes in einem Rack die speziellen Vorsichtsmaßnahmen, um sicherzustellen, dass das System nicht an Stabilität verliert.

Folgende Richtlinien dienen zur Sicherstellung Ihrer Sicherheit. Ist dieses Gerät die einzige Einheit, die in dem Rack einzubauen ist, so sollte es auf dem Rack-Boden angebracht werden. Wird das Rack teilweise genutzt, bauen Sie die Teile von unten nach oben ein. Die schwerste Komponente sollte stets unten im Rack eingebaut werden. Ist das Rack mit stabilisierendem Zubehör ausgestattet, montieren Sie zunächst diese Stabilisatoren, bevor Sie das Gerät in das Rack einbauen oder warten.

## Technische Daten

Allgemein	
Zulässiger Temperaturbereich bei der Lagerung	-20°C bis 60°C
Zulässige Luftfeuchtigkeit für Lagerung	85 % (max.)
Stromaufnahme	0,4 A (max.)
Gewicht	etwa 5,5 kg

## How to use this manual

### ■ Symbols used

- Note** : Describes precautions concerning the operation of this product.
- Memo** : Describes reference information, such as functions and usage restrictions of this product.
-  : Indicates the reference page numbers and reference items.

### ■ Content of this manual

- All rights reserved by JVC. Unauthorized duplication or reprinting of this manual, in whole or in part, is strictly prohibited.
- All other product names used in this manual are trademarks or registered trademarks of their respective companies. Marks such as <Arial Regular><sup>TM</sup>, ®, © have been omitted in this manual.
- Illustrated designs, specifications and other contents of this manual are subject to change for improvement without prior notice.

# Contents

## Introduction

Features	2
Precautions for Proper Use	3
Names of Parts	4

## Connection

Example of Basic Connection	8
Example of Connection with 2 Units	9
Rack Mounting	11
Turning the Power ON	11

## Preparations and Main Functions

Camera Cable Length Setup	12
Adjustments for Genlock Operation	12
Intercom	14
Camera Operator Call	14
Tally	14
Function Buttons	15

## Camera Adjustments

Shutter Speed Adjustment	16
Gain Adjustment	17
Iris Adjustment	17
White Balance Adjustment	18

## Menu Operation

Flow of Menu	19
Menu Setup Method	20
GENLOCK Menu	21
CABLE Menu	21
FILE Menu	22
PROCESS Menu	23
OPERATION Menu	25
LCD MODE Menu	26
SYSTEM Menu	26

## General

Warning Messages	28
Error Messages	28
Operable Camera Features	29
Operation of Connected Camera	30
Troubleshooting	31
Specifications	32

# Features

This is a remote control unit to program the HD studio system together with the HD Memory Card Camera Recorder (GY-HM790 series: GY-HM790U/GY-HM790CHU/GY-HM790E/GY-HM790CHE) and Multicore Remote Adapter (KA-M790G).

## Maximum 100m of HD analog component signals can be transferred

You can use the optional camera cable VC-P110 series to extend the distance between the camera and the remote control unit up to 100m and transfer the HD analog component signals.

There is no need to prepare a separate power source as the power to the studio adapter will be supplied by RM-HP790DU/RM-HP790DE.

## Equipped with HD/SD SDI connector

The unit can distribute and output (2 outputs) the input SDI signals from the SDI input connector. It can be connected to SDI switcher, monitor or other VTR equipment.

## The camera can be remotely controlled

The camera can be remotely controlled by serial communication. You can also control the camera by connecting the optional remote control panel RM-LP25U.

## External synchronization of HD studio system is possible

External synchronization of SD reference sync signal or (VBS or BB), HD tri-level reference sync signal for HD studio system is possible. H phase and SC phase (SD signal) can be adjusted on the front panel.

## Precautions for Proper Use

■ To prolong the service life of the RM-HP790DU/RM-HP790DE, do not use it or store it in the following places.

- A place subject to extremely high or low temperatures.
- A place subject to excessive vibration.
- A place subject to excessive dust.
- A place subject to high humidity.
- A place near to a strong source of noise.

■ Do not apply strong vibrations or impact to the RM-HP790DU/RM-HP790DE during installation or transportation.

■ If the supply voltage is too high or low, the service life of the RM-HP790DU/RM-HP790DE may be reduced or it may not be able to provide an optimum performance.

■ Do not connect or disconnect the camera cable connector while the RM-HP790DU/RM-HP790DE is ON.

■ After turning the RM-HP790DU/RM-HP790DE OFF, wait at least 10 seconds before turning it ON again.

■ Noise may interfere with the video when the RM-HP790DU/RM-HP790DE is installed near a source of strong magnetism, such as a radio or TV transmitting antenna, power transformer or motor.

■ While the values set by using the menus are retained in the memory even after the unit is turned off, those set using the front panel switches and controls are retained for about 10 days only and then the factory-set defaults are reset.

■ As the LCD contrast is reduced at low temperatures, it should be re-adjusted before use in such conditions.

(☞ Page 26 [CONTRAST])

■ When a transceiver or cellular phone is used near to a RM-HP790DU/RM-HP790DE or to a camera connected to it, noise may interfere with the video. However, this is not a malfunction.

■ When an intercom is used, radio interference may occasionally affect any system that is connected to the RM-HP790DU/RM-HP790DE.

■ In such a case the INTERCOM G (GND) terminal provided to the RM-HP790DU/RM-HP790DE should be grounded.

■ In a multiple camera setup, if the adjustments made to the different cameras deviate significantly, the cameras may not be able to function satisfactorily. Be sure to adjust the cameras accordingly before using them with the RM-HP790DU/RM-HP790DE.

■ Use camera cables with standard lengths, as specified. Otherwise, the camera cable compensation may not be able to work efficiently.

■ RM-HP790DU/RM-HP790DE can be connected to the following equipment:

- GY-HM790 series (HD Memory Card Camera Recorder)
- KA-M790G (Multicore Remote Adapter)
- KA-790G (Studio Adapter)
- VF-HP790G (Studio Viewfinder)

Functions not available on the camera cannot be controlled from this unit.

(☞ Page 29 [Operable Camera Features])

■ If the RM-HP790DU/RM-HP790DE is rack-mounted, be sure to insert ventilated panels above and below it in order to improve ventilation. Do not stack two RM-HP790DU/RM-HP790DE units or place any object on top of a RM-HP790DU/RM-HP790DE unit.

In addition, make sure to keep surrounding temperature of this unit below 40°C during use.

■ To save power consumption, turn the RM-HP790DU/RM-HP790DE OFF when it is not in use.

# Names of Parts

## Front panel

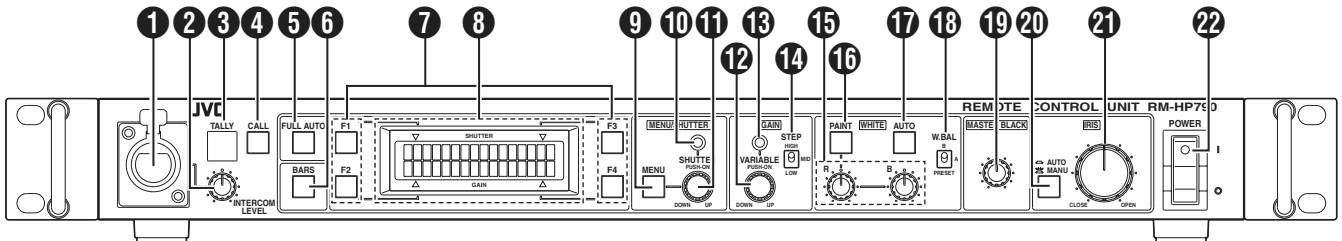

**1 Intercom connector**

Connect the intercom headset to this connector.  
(☞ Page 14 [Intercom])

**2 [INTERCOM LEVEL] control**

Use this knob to adjust the intercom earphone volume.

**3 [TALLY] lamp**

This lamp lights when a signal is input to the [TALLY] terminals 2 on the rear panel.  
It lights in red when a tally signal is input to the [TALLY PGM] terminal on the rear panel or in green when a tally signal is input to the [TALLY PVW] terminal.

**Memo :**

- The button lamps will light up and blink as below.
  - During CALL : [CALL] button blinks in red
  - TALLY PGM : [TALLY] lamp lights up in red
  - TALLY PVW : [TALLY] lamp lights up in green

**4 [CALL] button and indicator light\*1**

The camera operator can also be called without using the intercom. When this button is pressed once, the light in it lights up and the tally lamp on the camera blinks to inform the camera operator of a call. Pressing this button again turns off both the button light and tally light on the camera. It blinks in red when there is a CALL signal from the camera.

**5 [FULL AUTO] button and indicator light\*2**

When this button is pressed, the light in it lights up and the connected camera enters the FAS (Full-Auto Shooting) mode. Pressing the button again turns the light off.  
In the FAS mode, the BARS mode is switched OFF, and the auto level control, auto iris control and full-auto white balance control functions are performed automatically in an integrated manner.  
(☞ Page 29 [Operable Camera Features])

**Memo :**

- Functions not available on the camera cannot be controlled from this unit.

**6 [BARS] button and indicator light\*2**

When this button is pressed, the light in it lights up and the connected camera outputs the color bars signal.  
(☞ Page 12 [Adjustments for Genlock Operation])

**7 [F1] to [F4] function buttons and indicator light\*2**

Each of these buttons can turn the function assigned to it alternately ON and OFF.  
(☞ Page 15 [Function Buttons])

**8 LCD display**

This panel shows the [SHUTTER] and [GAIN] settings as well as the functions assigned to the function buttons.  
This panel is also used to show menus and various operation messages.  
The following display appears when the remote control panel is connected and during operate on.



**9 [MENU] button and indicator light**

When this button is held depressed for about 1 second, the button light is lit and the menu becomes variable. (The [SHUTTER] and [GAIN] lights should be off.)  
Pressing this button terminates a menu and turns the light in the button off.  
(☞ Page 20 [Menu Setup Method])

**10 [SHUTTER] light**

This light is turned on when the shutter speed variation facility is ON.  
Adjust the shutter speed using the [SHUTTER] control 11.

**11 [SHUTTER] control with ON/OFF button\*2**

When this knob is pressed, the shutter speed variation function is turned alternately ON and OFF.  
When the shutter speed variation is ON, the [SHUTTER] light 10 is turned on and turning the knob will vary the shutter speed.  
(☞ Page 16 [Shutter Speed Adjustment])

In [STEP] mode the shutter speed is varied in stages, fine adjustments can be made in [VARIABLE] mode.  
(☞ Page 25 [SHUTTER])

When the [MENU] light 9 is lit, turn the knob to switch between menu items, press the knob (to the ON position) to select an item.  
(☞ Page 20 [Menu Setup Method])

## 12 [GAIN-VARIABLE] control with ON/OFF button\*2\*3

When the button is pressed, the Variable Gain mode is switched "ON" and "OFF" alternately.

The [GAIN] light 13 is turned on when the Variable Gain mode is "ON".

When the [GAIN] mode is set to "VARIABLE", the Gain value can be varied from 0.1dB (or 1.0dB) to 18dB in 0.1dB (or 1.0dB) steps. The variation per step and the maximum gain value can be changed under the following items.

(☞ Page 25 [V. GAIN STEP] and [V. GAIN MAX])

## 13 [GAIN] light\*3

This light is turned on when the gain control is in the Variable Gain mode.

## 14 [GAIN-STEP LOW/MID/HIGH] switch\*2

The gain value can be selected according to the position of this switch.

[HIGT] : ☞ Page 25 [GAIN HIGH]

[MID] : ☞ Page 25 [GAIN MID]

[LOW] : ☞ Page 25 [GAIN LOW]

The selected gain value is shown in the LCD display 8 every time that the position of this switch is changed.

(☞ Page 17 [Gain Adjustment])

## 15 [WHITE-R/B] gain controls\*2

[R] : Use this knob to fine-adjust the R gain during the white paint operation or adjust the R gain during manual white balance adjustment.

[B] : Use this knob to fine-adjust the B gain during the white paint operation or adjust the B gain during manual white balance adjustment.

(☞ Page 18 [White Balance Adjustment])

## 16 [WHITE-PAINT] button and indicator light\*2

When this button is pressed so that the light in it lights up, the R and B gain values can be adjusted using the [R] and [B] controls 15. If the [W. BAL] switch 18 is set to "A" or "B", the white paint adjustment (fine adjustment of the R and B gain) can be performed using the [R] and [B] controls 15.

If the [W. BAL] switch 18 is set to "PRESET", the light in this button lights up and the [R] and [B] controls can vary the R and B gain values by a larger amount than usual 15.

## 17 [WHITE-AUTO] button and indicator light\*2

Press this button to start an auto white balance adjustment of the camera (within a second). This button is activated only when the [W. BAL] switch 18 is set to "A" or "B".

When the camera in use has the Auto Set function, pressing and holding this button for more than a second initiates the Auto Set mode and then starts the auto blackbalance and auto white balance adjustment operations. If the camera does not have an Auto Set function, pressing and holding this button for more than a second starts only the auto white balance adjustment operation.

(☞ Page 18 [White Balance Adjustment])

## Memo :

- When the camera performs the auto white operation or other Auto Set operations, the light in this button normally lights up and turns off when the camera completes the operation. If the adjustment has not been done correctly, the LCD display 8 shows an error message.
- The light in this button also lights up when the FAW (Full-time Auto White balance) adjustment function of the camera is functioning.

## 18 [WHITE-W. BAL B/A/PRESET] switch\*2

This switch switches the white balance control setting between the value stored in Memory "B" (AUTO 2), that stored in Memory "A" (AUTO 1) and the [PRESET] value (3200K).

When the white balance adjustment is "PRESET" and the [WHITE-PAINT] button 16 is pressed so that the light in it lights up, the white balance adjustment is set to the manual mode, in which the white balance can be adjusted with the [R] and [B] controls 15.

(☞ Page 18 [White Balance Adjustment])

## 19 [MASTER BLACK] control\*2

Use this knob to adjust the pedestal level, which is the black reference (master black) value.

## 20 [IRIS-AUTO/MANU] button and indicator light\*2

When this button is pressed so that the light in it lights the lens iris is set to the manual iris control mode. The lens iris level may be adjusted in this mode by using the [IRIS-CLOSE OPEN] control 21.

When this button is pressed so that the light in it turns off, the lens iris is set to the auto iris control mode. The auto iris level can be fine adjusted with the [IRIS-CLOSE OPEN] control 21.

## 21 [IRIS-CLOSE OPEN] control\*2

When the manual iris control mode is set (which is indicated by the lighting of the light in the [IRIS-AUTO/MANU] button 20), use this knob to adjust the iris aperture between [CLOSE] and [OPEN].

When the iris mode is "AUTO" (when the light in the button is not lit up), the auto iris level can be fine adjusted with this knob.

(☞ Page 17 [Iris Adjustment])

## 22 [POWER] switch

Press this switch to turn the power ON and OFF.

\*1 : When CALL function is available at the remote control panel, operation cannot be performed from the main unit when connected to the remote control panel.

\*2 : Operation cannot be performed from the main unit when connected to the remote control panel.

\*3 : 12 and 13 are unavailable when connected to GY-HM790 series.

# Names of Parts (continued)

## Rear panel

### ■ RM-HP790DU

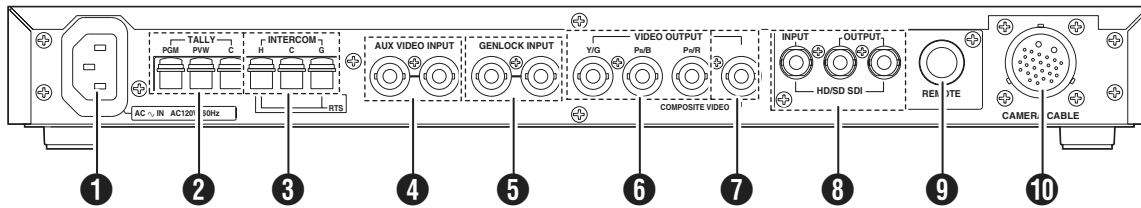

### ■ RM-HP790DE

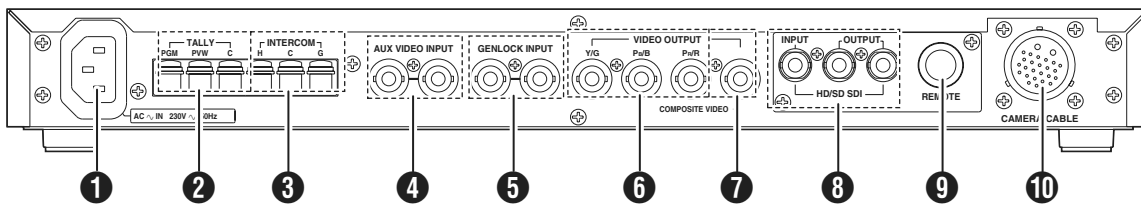

#### ❶ [AC~IN] Connector

Connect this socket to a commercial power supply outlet using the power cord provided.

#### ❷ [TALLY] Terminals

These terminals input the tally control signals. (☞ Page 14 [Tally])

#### ❸ [INTERCOM] Terminals

These terminals input and output the intercom signals. In a system composed of multiple cameras and remote control units, the intercom function provides intercommunication between operators. (☞ Page 14 [Intercom])

#### ❹ [AUX VIDEO INPUT] Connectors

These connectors are used to input the return video signal, which returns the SEG (Special Effects Generator) or switcher output signal to the camera viewfinder. These two connectors are loop-through connected inside to enable a bridge connection. They are terminated automatically when they are not bridge-connected. Input VBS.

#### ❺ [GENLOCK INPUT] Synchronous Signal Input Connectors

These connectors are for reference sync signal input. These two connectors are loop-through connected inside to enable a bridge connection. They are terminated automatically when they are not bridge-connected. Input BB or Tri-level sync signal.

#### ❻ [Y/G, Pb/B, Pr/R] Component Video Signal Output Connectors

The settings of the output signals from these connectors can be switched between Y/Pb/Pr, G/B/R using the Signal Serect switch on the connected camera or by using the menu setup of the camera.

#### ❼ [COMPOSITE VIDEO] Signal Output Connector

This connector outputs VBS (composite video) signal.

#### ❽ [HD/SD SDI INPUT/OUTPUT] SDI signal input and output connectors

These are HD/SD SDI signal input/output connectors. SDI signal that is input will be output from the [HD/SD SDI OUTPUT] connectors.

#### Memo :

- Transferred signals cannot be output via the camera cable from the [HD/SD SDI OUTPUT] connector on RM-HP790DU/RM-HP790DE. Signals will be output in the same format as the input signals to [HD/SD SDI INPUT] connector.

#### ❾ [REMOTE] Connection Connector of Remote Control Panel

This connector connects to the remote control panel and controls the camera. When connected, remote control panel operations will take priority over operations from RM-HP790DU/RM-HP790DE (3: FILE, 4: PROCESS, 5: OPERATION).



---

## ⑩ [CAMERA CABLE] Connector (26-pin)

Connect the optionally available camera cables to the camera.

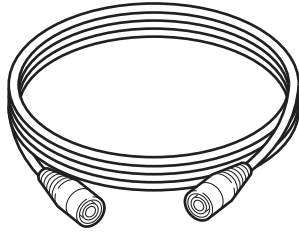

Camera Cable (Optional)

The VC-P110 series camera cables that can be used to connect a camera to the RM-HP790DU/RM-HP790DE are available in four lengths as listed below.

VC-P110	: 5 meters
VC-P112	: 20 meters
VC-P113	: 50 meters
VC-P114	: 100 meters

A menu setup is required according to the cables in use.  
(☞ Page 12 [Camera Cable Length Setup])

**Memo :** \_\_\_\_\_

- If it is required to extend the cable, use the KA-280 extension connector.
  - The total cable length should not exceed 100 meters.
-

# Example of Basic Connection

## Standard connection of the RM-HP790DU/ RM-HP790DE (Connection of a single unit)

■ When the RM-HP790DU/RM-HP790DE is connected to a camera.

**Memo :**

- When the RM-HP790DU/RM-HP790DE is connected to a camera, a local remote controller cannot be connected to the camera.
- \* 1 When connect the remote control unit cable to the [REMOTE] connector, please be careful to the following points.
  - To reduce the emission of unwanted radio waves and to avoid electrostatic influence, be sure to attach the provided clamp filter attached in RM-LP25U as shown in the figure.
  - Attach the clamp filter as close to connector as possible.

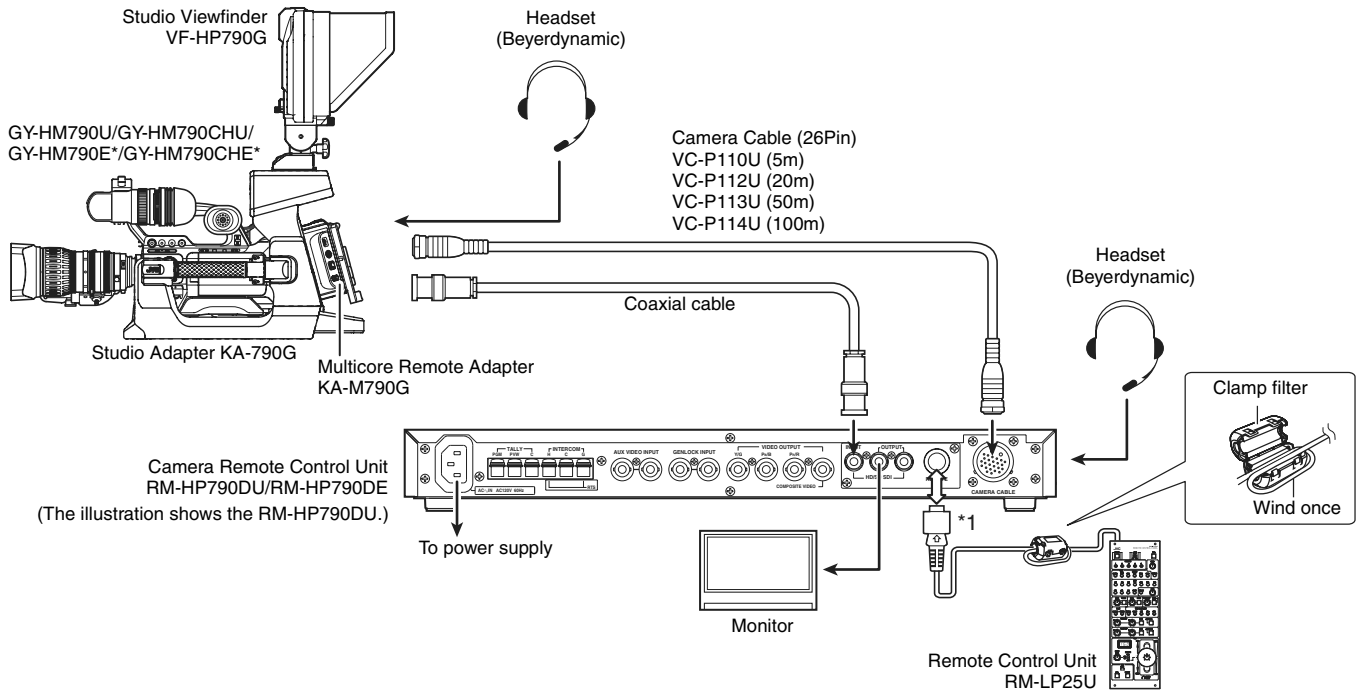

\* Models with an E suffix are for the European market and the UL Listing mark is not applicable.

# Example of Connection with 2 Units

## Standard connection of RM-HP790DU (Connection of 2 units)

### Memo :

- When the RM-HP790DU/RM-HP790DE is connected to a camera, a local remote controller cannot be connected to the camera.
- \* 1 When connect the remote control unit cable to the [REMOTE] connector, please be careful to the following points.
  - To reduce the emission of unwanted radio waves and to avoid electrostatic influence, be sure to attach the provided clamp filter attached in RM-LP25U as shown in the figure.
  - Attach the clamp filter as close to connector as possible.

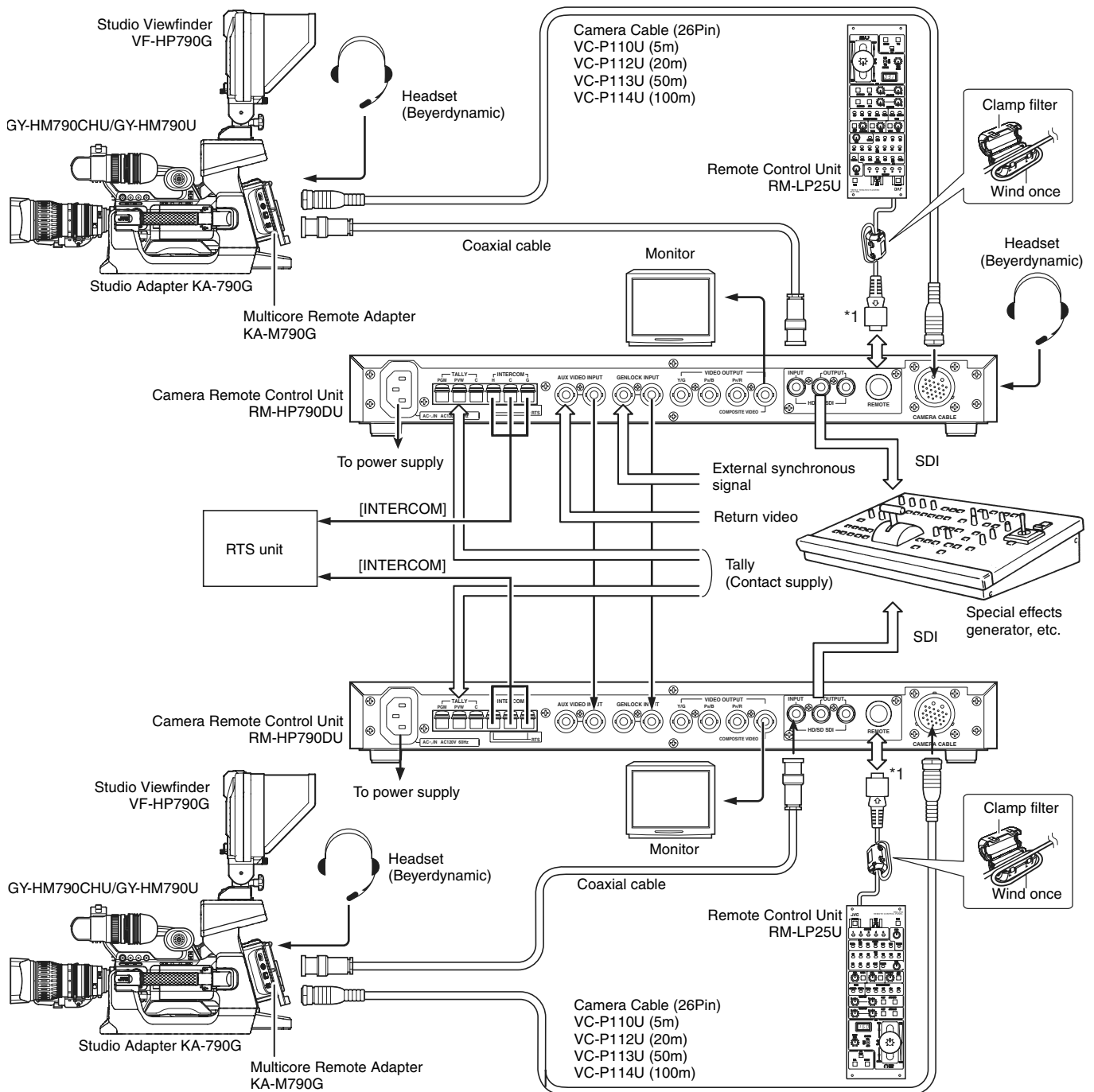

# Example of Connection with 2 Units (continued)

## Standard connection of RM-HP790DE (Connection of 2 units)

**Memo :**

- When the RM-HP790DU/RM-HP790DE is connected to a camera, a local remote controller cannot be connected to the camera.
- \* 1 When connect the remote control unit cable to the [REMOTE] connector, please be careful to the following points.
  - To reduce the emission of unwanted radio waves and to avoid electrostatic influence, be sure to attach the provided clamp filter attached in RM-LP25U as shown in the figure.
  - Attach the clamp filter as close to connector as possible.

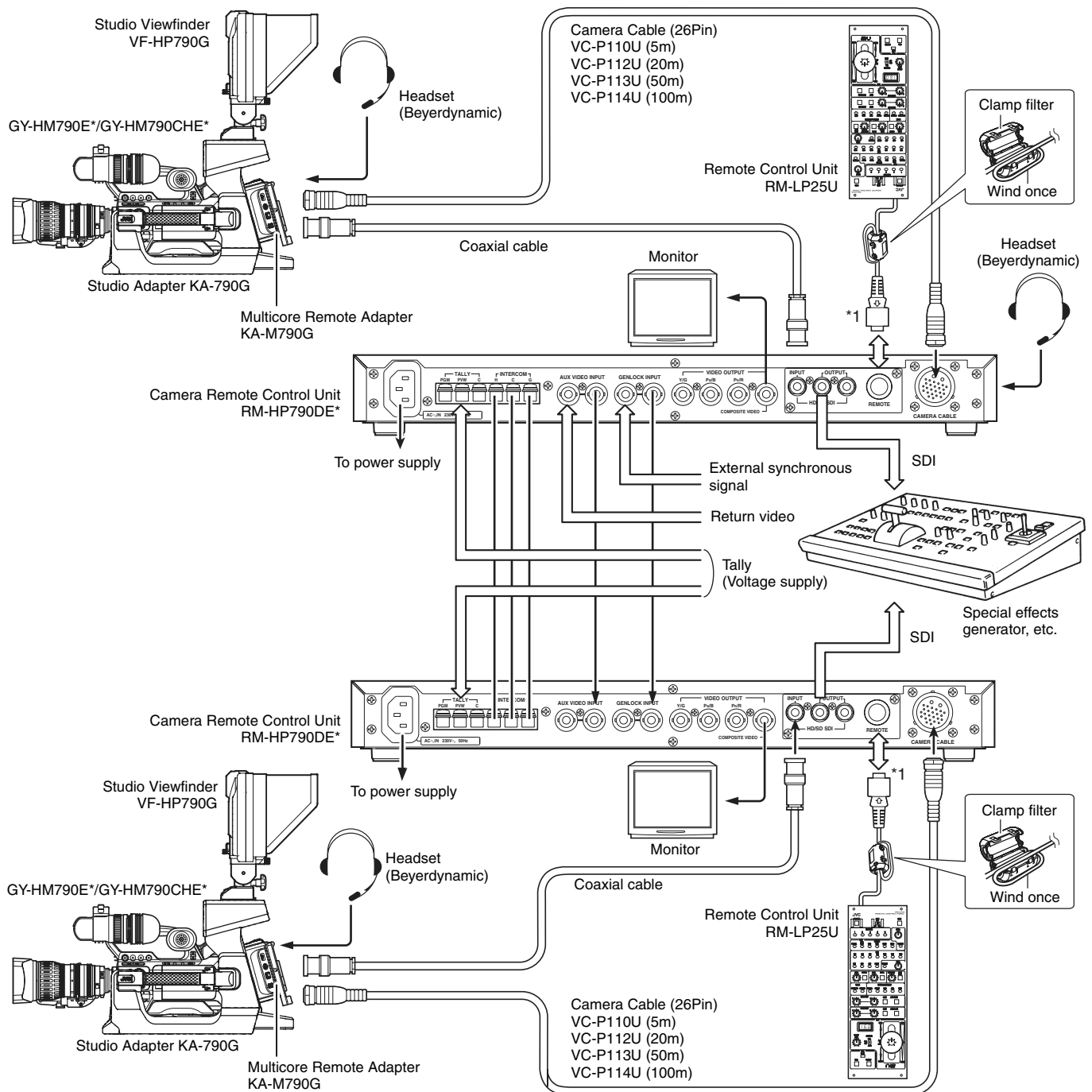

\* Models with an E suffix are for the European market and the UL Listing mark is not applicable.

## Rack Mounting

Mount this unit to the EIA rack.

### 1 Remove the screws ① on the four stands at the bottom

Remove the stands.

### 2 Mount the unit to the rack using the screws ②

Secure to the rack with the optional screws x4 (M5 x 10 mm)

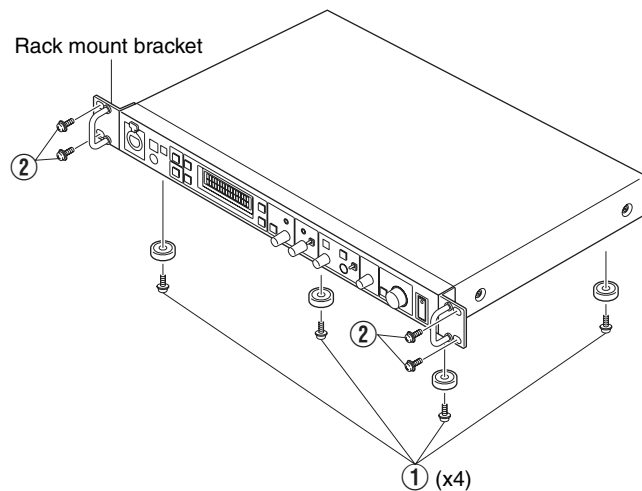

#### Memo :

- If the RM-HP790DU/RM-HP790DE is rack-mounted, be sure to insert ventilated panels above and below it in order to improve ventilation. Do not stack two RM-HP790DU/RM-HP790DE units or place any object on top of a RM-HP790DU/RM-HP790DE unit.
- In addition, make sure to keep surrounding temperature of this unit below 40°C during use.

## Turning the Power ON

1 Connect the camera to the RM-HP790DU/RM-HP790DE using a proper connection method

2 Press the [POWER] switch of the RM-HP790DU/RM-HP790DE to ON

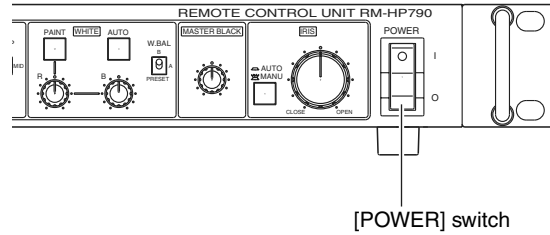

#### Memo :

- When an item is controllable from both the RM-HP790DU/RM-HP790DE and the camera, the control from the camera is defeated. Functions not available on the camera cannot be controlled from this unit.
- When connecting the RM-HP790DU/RM-HP790DE to the camera, do not connect a local remote controller to the camera.
- After turning the RM-HP790DU/RM-HP790DE OFF, wait at least 10 seconds before turning it ON again.

## Camera Cable Length Setup

Cable length setup is required when a camera is connected to the RM-HP790DU/RM-HP790DE for the first time or when the camera cable length is changed.

The cable length setup value is stored in the memory inside the RM-HP790DU/RM-HP790DE and is held even after it is turned OFF.

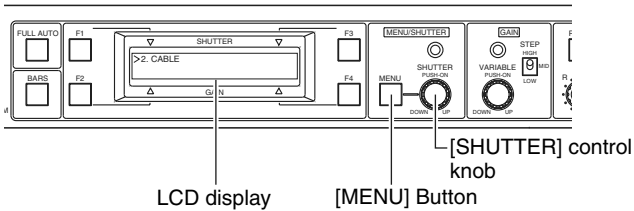

**1** Press and hold the [MENU] button for about 1 second until the LCD display shows the menu display. Turn the control knob to move the cursor (→) to “2: CABLE”

Cursor



**2** Press the [SHUTTER] control knob to display “2A: LENGTH”

Cursor

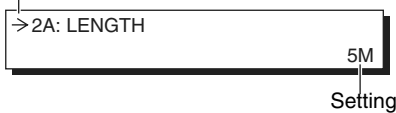

## Setting the cable length

**1** Press the [SHUTTER] control knob to move the cursor (→) to the currently set length

Cursor



**2** Turn the [SHUTTER] control knob to select the cable length that is to be used in meters (Variable to “5M”, “20M”, “50M” or “100M”)



**3** After setting the value, press the [SHUTTER] control knob to move the cursor (→) back to “2A: LENGTH”

## Adjustments for Genlock Operation

Genlocking is required for a system, which uses an SEG (special effects generator) as the main signal source. (☞ Page 9 [Example of Connection with 2 Units])

**Memo :**

- The following adjustments can be made more accurately when using a vectorscope and waveform monitor.
- Be sure to use an underscanned video monitor.
- It is not permitted to genlock the system components using a VCR playback signal.
- Before phase adjustment, wait a little for the phases of the connected components to stabilize.

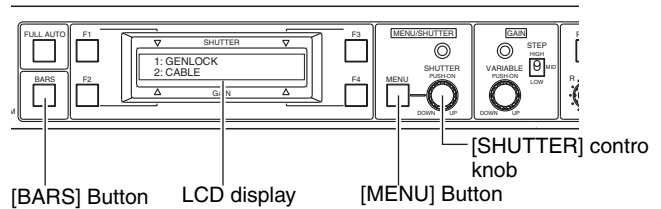

## Preparation

**1** Press the [BARS] button to output the color bar signal. The button light should light up

**2** Output the built-in color bar signal of the SEG from the program connector on the front panel of the SEG (☞ Refer to the [Instructions Manual] of the SEG)

**3** Observing the monitor screen at the same time, adjust the H PHASE (horizontal phase) and SC PHASE (subcarrier phase) while using the switch on the SEG to alternately change between color bars of the internal RM-HP790DU/RM-HP790DE that of the SEG

## Adjusting the H PHASE

**1** Press and hold the [MENU] button for about 3 seconds until the LCD display shows the menu display

Cursor



**2** Ensure that the cursor (→) is located on "1: GENLOCK", then press the control knob to display "1A: SD H PHASE" or "1B: HD H PHASE"

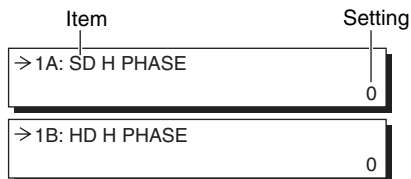

**3** Press the [SHUTTER] control knob to move the cursor (→) to the currently set value, then turn the [SHUTTER] control knob to adjust the H PHASE value (HD: -1024 to 1023, SD: -128 to 127)

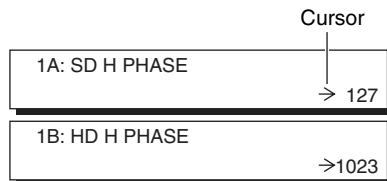

**4** After the adjustment, press the control knob to move the cursor (→) back to "1: GENLOCK"

**Memo :**

- Screens 2 and 3 differ according to the Video Format of the camera.

## Adjusting SC phase (Only for SD signal)\*1

\*1 This function is unavailable when connected to GY-HM790 series.

**1** Turn the [SHUTTER] control knob to display "1C: SC COARSE"



**2** Press the [SHUTTER] control knob to move the cursor (→) to the currently set value, then turn the [SHUTTER] control knob to adjust the SC COARSE value (to 0°, 90°, 180° or 270°)

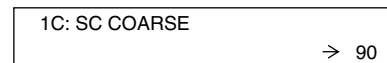

**3** After the coarse adjustment, press the [SHUTTER] control knob to move the cursor (→) back to "1C: SC COARSE", then press the [SHUTTER] control knob to display "1D: SC FINE"



**4** Press the [SHUTTER] control knob to move the cursor (→) to the currently set value, then turn the [SHUTTER] control knob to adjust the SC FINE value (from -128 to 127)

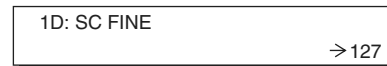

**Memo :**

- [SC COARSE] and [SC FINE] are linked. When the upper or lower limit of [SC FINE] is exceeded, the value of [SC COARSE] changes.  
For example, when the value of [SC COARSE] is "0°" and [SC FINE] is increased, once [SC FINE] exceeds "127", [SC COARSE] will become "90°" and [SC FINE] will become "-128".

**5** After the adjustment, press the [MENU] button to return to the previous display

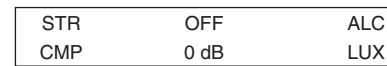

**6** Press the [BARS] button to stop the color bar signal output

## Preparations and Main Functions

### Intercom

Intercommunications between operators are necessary in a system composed of multiple cameras and remote control units.

**■ The factory settings vary depending on the model.**

RM-HP790DU : RTS system. \*1

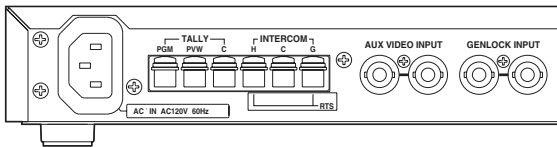

RM-HP790DE : 2-wire system, which uses the [H] and [C] terminals. \*1

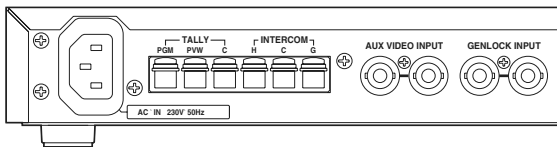

\*1 If tally and intercom settings (for changing model from DU to DE or vice versa) are required, the setting of the internal circuitry should be changed; consult the nearest JVC-authorized service agent. (The modifications and adjustments will be carried out with charge.)

### An intercom connector

An intercom connector is provided on the front panel of the RM-HP790DU/RM-HP790DE.

The volume level of the headset's earphone can be adjusted using the [INTERCOM LEVEL] control.

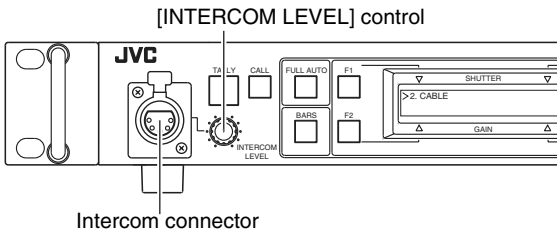

### Intercom Input Connector (XLR 5 Pin)

Input connector for intercom headset. (Dynamic only)  
Recommended headset: DT109 (Beyerdynamic)

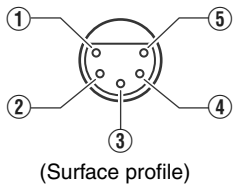

Signal	
①	MIC (H)
②	MIC (C)
③	EAR (C)
④	EAR (H) - LEFT
⑤	EAR (H) - RIGHT

**Memo :**

- Examples of suitable headsets  
DT109 (Beyerdynamic)  
Headsets from other manufacturers with:  
Microphone output impedance: 50 Ω to 200 Ω  
Earphone input impedance: 50 Ω to 400 Ω

### Camera Operator Call

This function makes it possible to call the camera operator without using the intercom. The camera operator is informed of the call by the blinking of the tally lamp on the camera.

When the [CALL] button is pressed, the button light is lit and the tally lamp on the camera blinks. Pressing the button again turns off both the button light and the blinking of the camera's tally lamp.

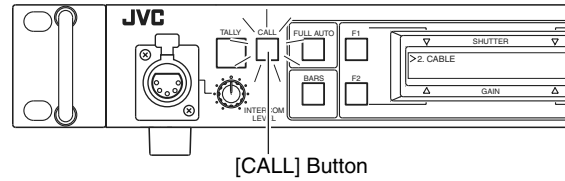

**Memo :**

- The tally lamp on the camera does not blink or light when either the camera or the RM-HP790DU/RM-HP790DE are switched off. When the [CALL] button of the camera is pressed, the [CALL] button of RM-HP790DU/RM-HP790DE blinks in red.

### Tally

The [TALLY] lamp on the front panel lights when signals are applied to the [TALLY] terminals on the rear panel.

**■ The factory settings vary depending on the model.**

RM-HP790DU : Contact supply mode\*1  
RM-HP790DE : Voltage supply mode\*1

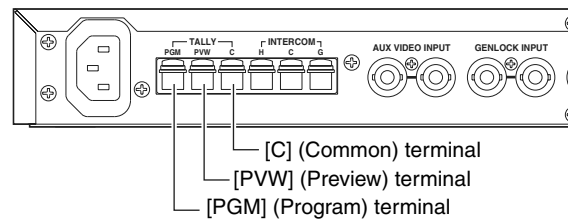

- [TALLY] lamp will light up in red when [PGM] (Program) terminal and [C] (Common) terminal are in the contact status (RM-HP790DU) or when 2 points of rated voltage are ignited (RM-HP790DE).
- [TALLY] lamp will light up in green when [PWV] (Preview) terminal and [C] (Common) terminal are in the contact status (RM-HP790DU) or when 2 points of rated voltage are ignited (RM-HP790DE).

\*1 If tally and intercom settings (for changing model from DU to DE or vice versa) are required, the setting of the internal circuitry should be changed; consult the nearest JVC-authorized service agent. (The modifications and adjustments will be carried out with charge.)



# Function Buttons

Up to four of the functions listed at the bottom of this page can be assigned to function buttons [F1] to [F4] so that each function can be switched on or off by pressing the corresponding button.

(For the assignment of functions: Page 25 [FUNC1] to [FUNC4] in the [OPERATION Menu].)

## Example of factory setting

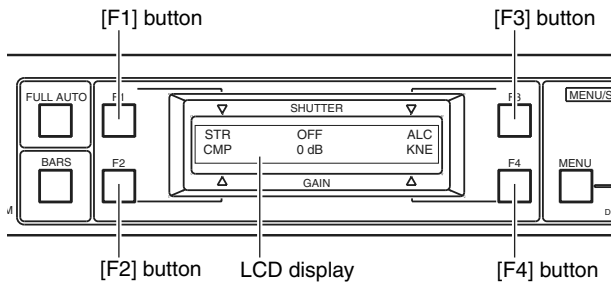

In the example above, the functions are assigned as shown in the following table.

Button	Display	Function
[F1]	STR	BLACK STRETCH
[F2]	CMP	BLACK COMPRESS
[F3]	ALC	ALC + EEI
[F4]	KNE	AUTO KNEE

In the figure above, the lights in all the function buttons are off, this indicates that all these functions are OFF. When a function is not available on the camera, “---” will be displayed.

## Switching an assigned function on/off

**1** When the [F1] button is pressed, the [BLACK STRETCH] function assigned to the [F1] button is switched from OFF to ON and the light in the button lights up

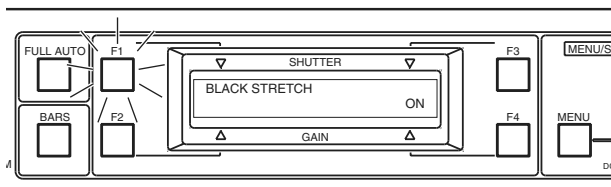

### Memo :

- The on/off condition of each function button can be set independently.

**2** When the [F1] button is pressed again, the [BLACK STRETCH] function is switched from ON to OFF and the light in the button turns off

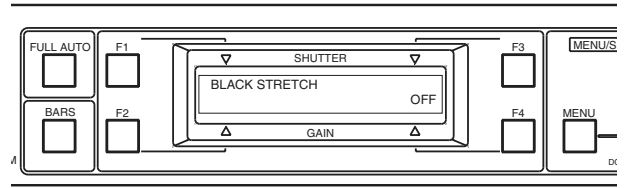

### Checking the assigned functions

Press the [MENU] button to display the functions assigned to the function buttons for about 3 seconds, in up to 7 characters per function as shown in the figure below.

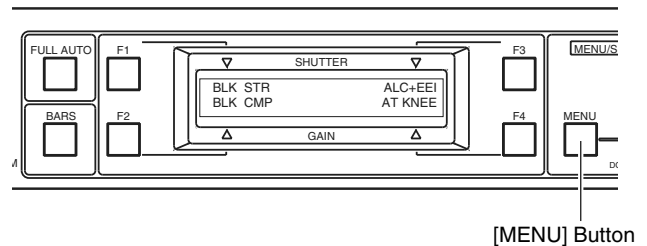

### Memo :

- When BLACK STRETCH and BLACK COMPRESS are assigned to two of the [F1] to [F4] buttons, it is not permitted to switch the two functions ON simultaneously. It is not permitted to switch both ALC + EEI and LOLUX ON.

Function Name	Display (3-Character)	Display (7-Character)
NONE	---	-----
BLACK STRETCH	STR	BLK STR
BLACK COMPRESS	CMP	BLK CMP
ALC + EEI	ALC	ALC + EEI
ALC	ALC	ALC
LOLUX* <sup>1</sup>	LUX	LOLUX
FAW	FAW	FAW
AUTO KNEE	KNE	AT KNEE
SKIN DETAIL	SKN	SKN DTL
COLOR MATRIX * <sup>1</sup>	MAT	COL MAT
DETAIL	DTL	DETAIL
DNR	DNR	DNR

\*<sup>1</sup> This function is unavailable when connected to GY-HM790 series.

# Shutter Speed Adjustment

Turning the [SHUTTER] control knob can vary the shutter speed of the camera. The LCD display shows the shutter speed during the adjustment operation.

**Memo :**

- When the FAS (Full Auto Shooting) is ON, the shutter speed becomes EEI. However, the shutter speed is OFF in the Lolux mode.
- When FAS is ON, the [SHUTTER] control knob cannot be used to vary the shutter speed.
- When [ALC + EEI] is ON, the shutter speed becomes EEI. At this time, the [SHUTTER] control knob cannot be used to vary the shutter speed.

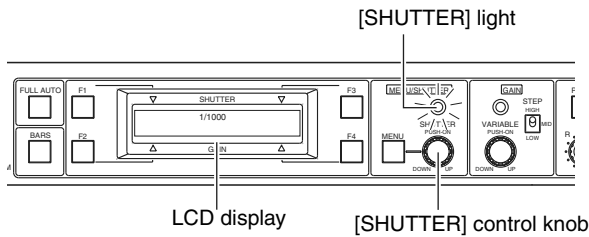

**1** Press the [SHUTTER] control knob to activate the shutter speed variation facility, which is indicated by the lighting of the [SHUTTER] light

**2** Turn the [SHUTTER] control knob to vary the shutter speed. The LCD display shows the shutter speed during the adjustment operation

The shutter speed can be adjusted in either [STEP] mode for adjustments in steps or in [VARIABLE] mode for fine adjustments.

- (☞ Page 25 [SHUTTER])
- (☞ Page 29 [Operable Camera Features])

[STEP] : Change the shutter speed with the fixed values.  
The fixed values differ depending on the Video Format of the camera.

Format	STEP value
HDV-HD60P HDV-HD30P DV-60I HDV-HD24P DV-24P DV-24PA	1/100, 1/250, 1/500, 1/1000, 1/2000, 1/4000, 1/10000
HDV-HD50P HDV-HD25P DV-50I DV-25P	1/120, 1/250, 1/500, 1/1000, 1/2000, 1/4000, 1/10000

[VARIABLE] : Use this mode when shooting an image on a computer monitor, etc.  
(Variation range: approx 1/50 to 1/2000)

\* The "VARIABLE" function is unavailable when connected to GY-HM790 series.

**Memo :**

- Values that are not available on the camera cannot be set on this unit.  
(☞ Page 29 [Operable Camera Features])
- The shutter speed displayed on the RM-HP790DU/RM-HP790DE may be slightly different from the actual shutter speed of the camera.

# Gain Adjustment

When the illumination of the object is insufficient, the electrical gain can be boosted as described below.

**Memo :**

- When the [FULL AUTO] or [ALC + EEI] is ON, the gain becomes ALC. However, the Gain is Lolux in the Lolux mode. The gain cannot be varied in this mode.

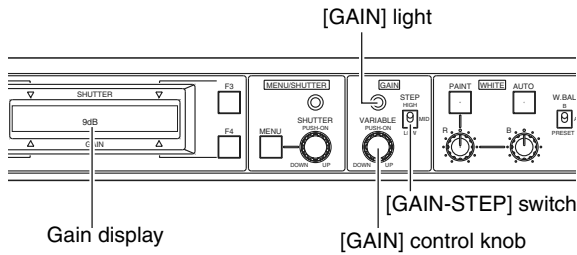

**1** The gain is boosted according to the position of the [GAIN-STEP] switch as shown below (The gain boost values shown below are factory settings.)

- LOW : 0 dB (No gain boost)
- MID : 9 dB (Gain approximately tripled.)
- HIGH : 18 dB (Gain approximately octupled.)

The gain boost values of these switch positions can be modified to the following values.  
 (Available values: -3 dB, 0 dB, 3 dB, 6 dB, 9 dB, 12 dB, 15dB, 18 dB)  
 (☞ Page 25 [GAIN LOW], [GAIN MID] and [GAIN HIGH])

**Memo :**

- Values that are not available on the camera cannot be set on this unit.
- “-3 dB” is not displayed when connected to GY-HM790 series.  
 (☞ Page 29 [Operable Camera Features])

**2** When the [GAIN] control knob is pressed, the Variable Gain mode starts and the [GAIN] light is turned on

**Memo :**

- The gain value set in the Variable Gain mode is applied in priority over the gain switch setting.
- This function is unavailable when connected to GY-HM790 series.

**3** The gain can be fine adjusted between 0.1dB and 18dB in 0.1dB steps in the Variable Gain mode. Also, in this mode, the maximum gain value can be set to “9 dB”, “12 dB” or “18 dB”

When the variation step is set to “1.0 dB”, the gain can be varied from 1dB to 18dB in 1dB steps.  
 (☞ Page 25 [V. GAIN STEP] and [V. GAIN MAX])

# Iris Adjustment

The camera lens iris can be adjusted from the RM-HP790DU/RM-HP790DE.

**Memo :**

- When the light in the [IRIS-AUTO/MANU] button is not lit, the iris control is set to Auto mode, in which the iris level is controlled automatically according to the light intensity. The auto iris value cannot be adjusted with the [IRIS-CLOSE OPEN] control knob.

**1** When the light in the [IRIS-AUTO/MANU] button is lit by pressing the button, the iris control is set to Manual mode, in which the iris level can be controlled using the [IRIS-CLOSE OPEN] control

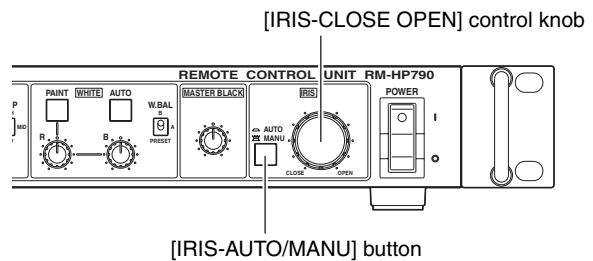

**Memo :**

- Set [IRIS MODE] switch of lens to side “A”.

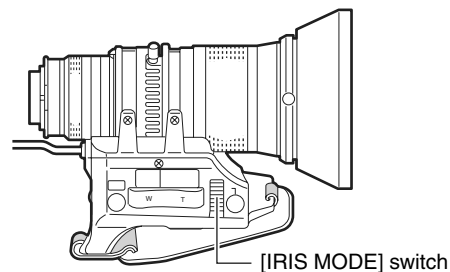

- When [ALC + EEI] or [FULL AUTO] is “ON”, the [IRIS-AUTO/MANU] button is forced to the Auto mode.  
 (☞ Consult the [INSTRUCTION MANUAL] of the camera in use.)

# White Balance Adjustment

Since color temperature varies depending on the light source, the white balance should be adjusted whenever the main light source illuminating the object being shot changes.

## AUTO white balance adjustment (Auto Set)

- 1 Press the [W. BAL] switch to select memory "B" or "A"
- 2 Press the [WHITE-AUTO] button to start the auto white balance adjustment of the camera within a second
  - When the connected camera has an Auto Set function, pressing and holding the button for more than a second initiates the Auto Set mode and starts the auto blackbalance and auto white balance adjustment operations.
  - When the camera does not have the Auto Set function, it is only the auto white balance adjustment that is started by this button.
  - When the white balance is adjusted properly, the LCD display shows "AUTO WHITE A(B) OK".

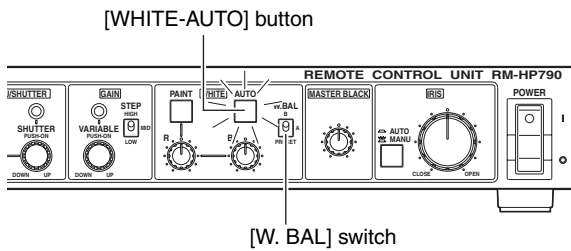

- Memo :**
- The light in the button lights up during an auto white balance adjustment or an Auto Set of the camera and turns off when it completes.
  - The light in the button also lights up when the FAW (Full Auto White) balance adjust function of the camera is working.
  - The LCD display shows the operating status of the auto white balance adjustment or Auto Set operation.
  - If the white balance is not adjusted properly, the LCD display shows an error message. (See Page 28 [Error Messages])

## White paint operation

This can be performed after completion of the auto white balance adjustment and enables the fine adjustment of the white balance using the [R] and [B] gain controls.

- 1 Press the [WHITE-PAINT] button so that the light in it lights up
- 2 While observing the color monitor screen, finely adjust the [R] and [B] gain levels using their respective controls

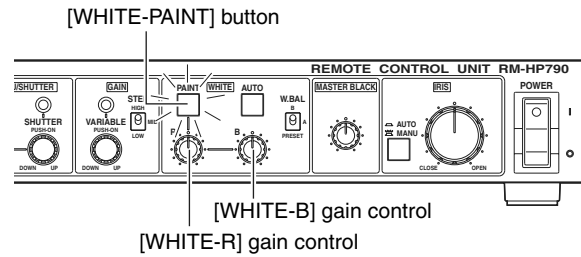

- Memo :**
- The white paint operation is not capable of making large variations in the [R] and [B] gain levels.
  - The white paint operation is turned OFF automatically when the auto white balance adjustment is started.

## MANUAL white balance adjustment

This function enables the manual adjustment of the white balance using the [R] and [B] gain controls. Use an oscilloscope or waveform monitor for this adjustment.

- 1 Set the [W. BAL] switch to "PRESET"
- 2 Press the [WHITE-PAINT] button so that the light in it turns off, indicating the manual white balance adjust mode
- 3 While observing the oscilloscope or waveform monitor, adjust the [R] and [B] gain levels using their respective controls

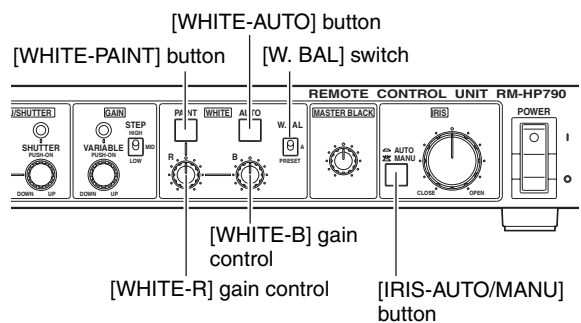

- Memo :**
- When [FULL AUTO] or FAW is ON, the white balance adjustment becomes the FAW (Full-time Auto white) mode. In this mode, the light in the [IRIS-AUTO/MANU] button lights and all of the white balance-related operation ([GAIN] control knob, [W. BAL] switch or [WHITE-PAINT]) are defeated.

# Menu Operation

## Flow of Menus

**Memo :** \_\_\_\_\_  
 ● The items and values that are not available with the camera are not menus displayed.

The menus displayed on the RM-HP790DU/RM-HP790DE are provided in the form shown below.

Category	Item	Variable Value
<b>1: GENLOCK</b> (Page 21)	1A: SD H PHASE	-128 to 0 to 127
	1B: HD H PHASE	-1024 to 0 to 1023
	1C: SC COARSE	0 , 90 , 180 , 270
	1D: SC FINE	-128 to 0 to 127
	1Z: BACK	
<b>2: CABLE</b> (Page 21)	2A: LENGTH	5M, 20M, 50M, 100M
	2Z: BACK	
<b>3: FILE</b> (Page 22)	3A: LOAD FILE	A, B, C, D, BACK
	3B: STORE FILE	A, B, C, D, BACK
	3C: RESET FILE	A, B, C, D, BACK
	3Z: BACK	
<b>4: PROCESS</b> (Page 23, 24)	4A: DETAIL	Netted items <input type="checkbox"/> are saved in the scene file. OFF, ON
	4B: DETAIL LEVEL	-10 to NORMAL to 10
	4C: DETAIL V/H	-10 to NORMAL to 10
	4D: DETAIL FRQ.	LOW, MIDDLE, HIGH, AUTO
	4E: SKIN DETAIL	OFF, ON
	4F: AUTO KNEE	OFF, ON
	4G: KNEE POINT	-10 to NORMAL to 10
	4H: COLOR MATRIX	OFF, ON
	4I: V.RESOLUTION	NORMAL, V.MAX
	4J: GAMMA	OFF, ON
	4K: GAMMA LEVEL	-10 to NORMAL to 10
	4L: BLACK	NORMAL, STRETCH, COMPRESS
	4M: ASPECT RATIO	4:3, 16:9, LETTER
	4N: DNR	OFF, ON
	4O: DNR LEVEL	LOW, MIDDLE, HIGH, AUTO
	4Z: BACK	
<b>5: OPERATION</b> (Page 25)	5A: SHUTTER	Netted items <input type="checkbox"/> are saved in the scene file. STEP, VARIABLE
	5B: V. GAIN STEP	0.1 dB, 1.0 dB
	5C: V. GAIN MAX	9.0 dB, 12.0 dB, 18.0 dB
	5D: GAIN LOW	-3 dB, 0 dB, 3 dB, 6 dB, 9 dB, 12 dB, 15 dB, 18 dB
	5E: GAIN MID	-3 dB, 0 dB, 3 dB, 6 dB, 9 dB, 12 dB, 15 dB, 18 dB
	5F: GAIN HIGH	-3 dB, 0 dB, 3 dB, 6 dB, 9 dB, 12 dB, 15 dB, 18 dB
	5G: SMOOTH TRANS	OFF, ON
	5H: FUNC1	*2
	5I: FUNC2	*2
	5J: FUNC3	*2
	5K: FUNC4	*2
	5Z: BACK	
<b>6: LCD MODE</b> (Page 26)	6A: CONTRAST	-5 to NORMAL to 5
	6B: BACKLIGHT	OFF, ON
	6Z: BACK	
<b>7: SYSTEM</b> (Page 26)	7A: SYSTEM RESET	*3 CANCEL, OK
	7Z: BACK	
<b>8: EXIT</b>		

\*1 Check screens are provided for items LOAD FILE and STORE FILE.

\*2 The options for FUNC1 to FUNC4 are common:  
 BLACK STRETCH, BLACK COMPRESS,  
 ALC + EEI, ALC,  
 LOLUX, FAW,  
 AUTO KNEE, SKIN DETAIL,  
 COLOR MATRIX, DETAIL,  
 DNR, NONE

\*3 This is not displayed when connected to the remote control panel. Operation cannot be performed from the main unit.



## GENLOCK Menu

This menu is used to set the camera cable length to the length actually used.

(☞ Page 12 [Adjustments for Genlock Operation])

\* Default values are indicated in bold characters.

No.	Item	Setting Values	Function
1A	<b>SD H PHASE</b> *1	-128 to <b>0</b> to 127	Adjustment of the Horizontal sync phase of genlocking.
1B	<b>HD H PHASE</b>	-1024 to <b>0</b> to 1023	Adjustment of the Horizontal sync phase of genlocking.
1C	<b>SC COARSE</b> *1	<b>0°</b> , 90°, 180°, 270°	Coarse adjustment of the color phase of genlocking. Use a vectorscope, etc.
1D	<b>SC FINE</b> *1	-128 to <b>0</b> to 127	Fine adjustment of the color phase, which should be performed after completing the [SC COARSE] adjustment. If the subcarrier cannot be adjusted with [SC FINE], restart the adjustment from [SC COARSE].
1Z	<b>BACK</b>	—	Return to the previous display.

\*1 This function is unavailable when connected to GY-HM790 series.

**Memo :** \_\_\_\_\_

- Either [1A: SD H PHASE] or [1B: HD H PHASE] will appear depending on the Video Format of the camera.

## CABLE Menu

This menu sets the camera cable length according to the actual length used.

(☞ Page 12 [Camera Cable Length Setup])

\* Default values are indicated in bold characters.

No.	Item	Setting Values	Function
2A	<b>LENGTH</b>	5M, <b>20M</b> , 50M, 100M	Set according to the total length of the camera cables in use.
2Z	<b>BACK</b>	—	Return to the previous display.

# Menu Operation

## FILE Menu

The values set with the menu and applied to the RM-HP790DU/RM-HP790DE can be saved in four files named A, B, C and D.

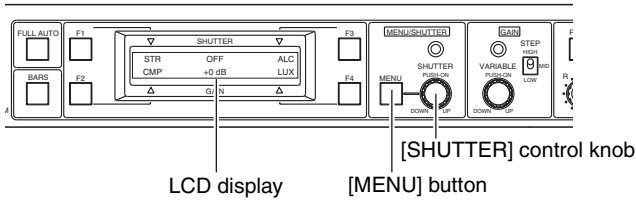

**1** Press and hold the [MENU] button for 3 seconds until the LCD display shows the menu display

The cursor (→) indicates that the item being pointed to can be varied.

Cursor



**2** Turn the [SHUTTER] control knob to move the cursor (→) to “3: FILE”

Cursor



**3** Press the [SHUTTER] control knob to move the cursor (→) below to “3A: LOAD FILE”



### ■ Storing data in a file

**4** To store data in one of the two files, press the [SHUTTER] control knob to move the cursor (→) to “3B: STORE FILE”



**5** Press the [SHUTTER] control knob again to move the cursor (→) to “A”



**6** To store data in file B, turn the control knob to move the cursor (→) to file “A” (Similar for “C”, “D”)



**7** If the [SHUTTER] control knob is pressed now, the LCD display shows “STORE FILE B” and the cursor (→) moves to “CANCEL”

If it is not required to write data now, the [SHUTTER] control knob should be pressed again.



**8** To store data in a selected file, turn the [SHUTTER] control knob to move the cursor (→) moves to “EXECUTE”



**9** Press the [SHUTTER] control knob to write data in a selected file and return to the previous display

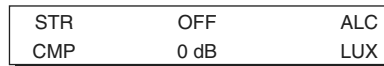

### ■ Loading the data in a file

To read previously written data, in step 3 move the cursor (→) to “3A: LOAD FILE”, then perform the same operations as in steps 4 to 9.

### ■ Resetting data in a file

To reset saved data to the factory settings, in step 3 move the cursor (→) to “3C: RESET FILE”, then perform the same operations as those in steps 4 to 9.

#### Memo :

- During LOAD FILE and RESET FILE, “NOW INITIALIZING” and “JUST A MOMENT” will be displayed on the LCD.



# PROCESS Menu

This menu sets the functions built into the camera.

\* Default values are indicated in bold characters.

**Memo :** \_\_\_\_\_

- Functions not available on the camera cannot be controlled from this unit.

No.	Item	Setting Values	Function
4A	<b>DETAIL</b>	OFF <b>ON</b>	ON/OFF setting of the detail enhancement function. OFF : Detail enhancement is activated. ON : Detail enhancement is deactivated.
4B	<b>DETAIL LEVEL</b>	-10 to <b>NORMAL</b> to 10 (21 steps)	Adjusts the detail enhancement level. Increasing the level : Sharpens details. Decreasing the level : Softens details.
4C	<b>DETAIL V/H</b>	-10 to <b>NORMAL</b> to 10 (21 steps)	Selects whether the detail enhancement is applied more strongly in a horizontal or vertical direction. Increasing the level : Applies detail enhancement more strongly in a H direction. Decreasing the level : Applies low detail enhancement in the H direction. <b>Memo :</b> _____ ● This item cannot vary the detail enhancement in the V direction.
4D	<b>DETAIL FRQ</b>	LOW <b>MIDDLE</b> HIGH AUTO	Sets the detail enhancement frequency according to the object. LOW : Low frequency to be used when shooting a coarsely patterned object. MIDDLE : Standard frequency. HIGH : High frequency to be used when shooting a small or finely patterned object. AUTO*1 : Automatic adjustment of the detail enhancement frequency according to the object.
4E	<b>SKIN DETAIL</b>	OFF <b>ON</b>	ON/OFF setting of the skin tone detail function, which displays natural, wet skin colors by reducing detail enhancement on the skin areas. OFF : Skin tone detail function is deactivated. ON : Skin tone detail function is activated.
4F	<b>AUTO KNEE</b>	OFF <b>ON</b>	ON/OFF setting whether the [AUTO KNEE] function is activated according to the knee point setting to be made below. OFF : [AUTO KNEE] function is deactivated. ON : [AUTO KNEE] function is activated.
4G	<b>KNEE POINT</b>	-10 to <b>NORMAL</b> to 10	Sets the knee point level at which the [AUTO KNEE] function is deactivated. Increasing the level : The knee function is activated at a higher video level. Decreasing the level : The knee function is activated at a lower video level. <b>Memo :</b> _____ ● The actual variation in the knee point occurs step by step because this is set as a result of the knee point setting of the camera.
4H	<b>COLOR MATRIX</b> *1	OFF <b>ON</b>	ON/OFF setting of whether the color matrix function. OFF : The color matrix function is deactivated. ON : The color matrix function improves the color reproducibility. Note that noise increases with this setting.
4I	<b>V.RESOLUTION</b> *1	<b>NORMAL</b> V.MAX	Increases the vertical resolution. NORMAL : Standard value. V.MAX : Increased value. <b>Memo :</b> _____ ● When the vertical resolution is increased, the sensitivity deteriorates and bright areas of objects may appear to be colored.

\*1 This function is unavailable when connected to GY-HM790 series.

## PROCESS Menu (continued)

\* Default values are indicated in bold characters.

No.	Item	Setting Values	Function
4J	<b>GAMMA</b>	OFF <b>ON</b>	ON/OFF setting of the gamma curve correction, which determines the reproduction of black. OFF : Gamma correction is deactivated. ON : Gamma correction is activated.
4K	<b>GAMMA LEVEL</b>	-10 to <b>NORMAL</b> to 10	Adjusts the gamma correction level. Increasing the level : Improves the reproduction of black but leads to loss of gradation of white. Decreasing the level : To be used when the reproduction of black is not strongly required.
4L	<b>BLACK</b>	<b>NORMAL</b> STRETCH COMPRESS	Sets the gain in the dark areas according to the captured video signal. NORMAL : Standard gain. STRETCH : Stretches the signals of the dark areas in the image to enhance them and clarify the difference between the bright and dark areas. COMPRESS : When the captured image is bright in overall and has few contrast, The gain of the dark areas is compressed to provide contrast.
4M	<b>ASPECT RATIO</b> *1	<b>4:3</b> 16:9 LETTER	Sets the picture size of the video signal. 4:3 : 4:3 screen output. 16:9 : 16:9 screen output. LETTER : Letter size (16:9) screen output.
4N	<b>DNR</b>	<b>OFF</b> ON	ON/OFF setting of the DNR (Digital Noise Reduction). OFF : DNR is deactivated. ON : DNR is activated.
4O	<b>DNR LEVEL</b> *1	LOW <b>MIDDLE</b> HIGH AUTO	Sets the DNR effect level. LOW : Low DNR level (effective for fast-moving objects). MIDDLE : Standard DNR level (residual image is noticeable). HIGH : High DNR level (residual image is noticeable). AUTO : Automatic adjustment of the DNR level according to the object.
4Z	<b>BACK</b>	—	Return to the previous display.

\*1 This function is unavailable when connected to GY-HM790 series.

# OPERATION Menu

This menu sets the functions built into the RM-HP790DU/RM-HP790DE.

\* Default values are indicated in bold characters.

No.	Item	Setting Values	Function
5A	SHUTTER *1	STEP VARIABLE	Selects whether the front panel [SHUTTER] control varies the shutter speed in steps or in fine variation. STEP : Shutter speed variation in steps. VARIABLE : Fine, continual variation to be used when shooting a computer monitor, etc.
5B	V. GAIN STEP *1	1.0 dB <b>0.1 dB</b>	Selects the step of the gain variation using the [GAIN] control in the Variable Gain mode. 1.0 dB : Turning the [GAIN] control varies the gain in 0.1 dB steps. 0.1 dB : Turning the [GAIN] control varies the gain in 1.0 dB steps.
5C	V. GAIN MAX *1	9.0 dB 12.0 dB <b>18.0 dB</b>	Selects the maximum gain value in the Variable Gain mode. 9.0 dB : Turning the [GAIN] control can vary the gain up to 9.0 dB. 12.0 dB : Turning the [GAIN] control can vary the gain up to 12.0 dB. 18.0 dB : Turning the [GAIN] control can vary the gain up to 18.0 dB.
5D	GAIN LOW	-3 dB*1, <b>0 dB,</b> 3 dB, 6 dB, 9 dB, 12 dB, 15 dB, 18 dB	Selects the gain value when the front panel [GAIN] switch is set to the "LOW" position.
5E	GAIN MID	-3 dB*1, 3 dB, 6 dB, <b>9 dB,</b> 12 dB, 15 dB, 18 dB	Selects the gain value when the front panel [GAIN] switch is set to the "MID" position.
5F	GAIN HIGH	-3 dB*1, 3 dB, 6 dB, 12 dB, 15 dB, <b>18 dB</b>	Selects the gain value when the front panel [GAIN] switch is set to the "HIGH" position.
5G	SMOOTH TRANS	OFF ON	ON/OFF setting of the smooth transition function which prevents sudden change when the position of the [GAIN] switch or [W. BAL] switch on the front panel is changed. OFF : SMOOTH TRANS is deactivated. ON : SMOOTH TRANS is activated.
5H	FUNC1	NONE, BLACK STRETCH, BLACK COMPRESS, ALC + EEI*1*2, ALC*2, LOLUX*1, FAW, AUTO KNEE,	Sets the function assigned to function button [F1] on the front panel. <b>(Default values: BLACK STRETCH)</b>
5I	FUNC2		Sets the function assigned to function button [F2] on the front panel. <b>(Default values: BLACK COMPRESS)</b>
5J	FUNC3		Sets the function assigned to function button [F3] on the front panel. <b>(Default values: ALC + EEI)</b>
5K	FUNC4		Sets the function assigned to function button [F4] on the front panel. <b>(Default values: AUTO KNEE)</b>
5Z	BACK	—	Return to the previous display.

\*1 This function is unavailable when connected to GY-HM790 series.

\*2 "ALC + EEI" and "ALC" cannot be registered at the same time.

## Menu Operation

### LCD MODE Menu

This menu sets up the LCD display.

\* Default values are indicated in bold characters.

No.	Item	Setting Values	Function
6A	CONTRAST	-5 to <b>NORMAL</b> to 5	Adjusts the contrast of the LCD display.
6B	BACKLIGHT	OFF <b>ON</b>	Adjusts the setting of the backlight of the LCD display. OFF : Backlight is turned off. ON : Backlight is turned on.
6Z	BACK	—	Return to the previous display.

### SYSTEM Menu

This menu performs setting regarding System.

\* Default values are indicated in bold characters.

No.	Item	Setting Values	Function
7A	CONTRAST	<b>CANCEL</b> EXECUTE	Resets the values set by the user to the initial values. (☞ Page 26 [SYSTEM RESET])
7Z	BACK	—	Return to the previous display.

### SYSTEM RESET

This menu resets the values set by the user to the initial values.

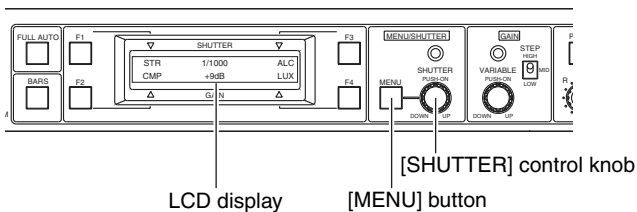

**1** Press and hold the [MENU] button (approx. 1 second) until the LCD display shows the menu display

**2** Turn the [SHUTTER] control knob to move the cursor (→) to “7: SYSTEM”

Cursor



**3** Press the [SHUTTER] control knob to display “7A: SYSTEM RESET”



**4** Press the [SHUTTER] control knob to move the cursor (→) to “CANCEL”

If you do not want to reset the values you have set, press the control knob now.



**5** If you want to reset the values, turn the [SHUTTER] control knob to move the cursor (→) to “EXECUTE”

“NOW INITIALIZING” and “JUST A MOMENT” will be displayed during SYSTEM RESET.

7A: SYSTEM RESET	→ EXECUTE
------------------	-----------

NOW INITIALIZING
JUST A MOMENT

**6** Press the [SHUTTER] control knob to reset the values you have set to the initial values and return to the normal display

STR	OFF	ALC
CMP	0 dB	LUX

## Initial values

- The values you've set in the menu items will be reset to the initial values shown on pages 21 to 26.
- Other status settings are reset as shown below.

Status Setting	Default values
[IRIS-AUTO/MANU] button	[MANUAL]
[W. BAL] switch	Switch position
[WHITE-PAINT] button	OFF
[WHITE-PAINT] switch	[A] [B] ch [R] ch Central value of the control
	[B] [B] ch [R] ch Central value of the control
[WHITE-PAINT] switch	[B] ch [R] ch Central value of the control
[GAIN-STEP] switch	Switch position
[GAIN-VARIABLE] control	[0.1 dB]
SHUTTER	[OFF]
V.SCAN LEVEL	Approx. 1/100(AU), 1/120(DE)
[FULL AUTO]	[OFF]
[BARS]	[OFF]
[F1] to [F4] buttons	Initial value, [OFF]
[LOLUX]	[OFF]
[ALC + EEI]	[OFF]

## Warning Messages

To prevent operational errors, the LCD display shows one of the following warning messages when an erroneous operation is performed.

Displayed Message	Cause	Check Point
<b>INVALID ENTRY GAIN : LOLUX</b>	The gain is set to the Lolux mode.	Exit from the Lolux mode, and then adjust the gain again.
<b>INVALID ENTRY FULL AUTO : ON</b>	The [FULL AUTO] button is ON.	Press the [FULL AUTO] button so that the lamp in it turns off, then retry operation.
<b>INVALID ENTRY GAIN : ALC + EEI</b>	[ALC + EEI] is "ON".	Exit from the [ALC + EEI] mode, and then retry operation.
<b>INVALID ENTRY GAIN : ALC</b>	[ALC] is "ON".	Exit from the [ALC] mode, and then retry operation.
<b>INVALID ENTRY W.BAL : FAW</b>	The white balance is set to the FAW mode.	Cancel FAW and start the white balance adjustment.
<b>INVALID ENTRY W.BAL : PRESET</b>	The [W. BAL] button is set to "PRESET".	Auto white balance adjustment cannot be started in this mode.
<b>INVALID ENTRY W.BAL : MANUAL</b>	The white balance adjustment is set to manual mode by the [WHITE-AUTO] button.	Auto white balance adjustment cannot be started in this mode.
<b>INVALID ENTRY BARS : ON</b>	The [BARS] button is pressed.	Press the [BARS] button so that the lamp in it turns off, then retry operation.

## Error Messages

When the LCD display shows one of the following error messages during an auto white balance adjustment and Auto Set mode, check "Cause" and "Check Point" below and then retry the auto white balance adjustment. (The error message is displayed for about 5 seconds.)

Displayed Message	Cause	Check Point
<b>AUTO WHITE A (B) ERROR: LOW LIGHT</b>	The light intensity is insufficient.	Increase the lighting (illumination) or boost the gain with the [GAIN] button. (Note that the sensitivity deteriorates when the gain is boosted.)
<b>AUTO WHITE A (B) NG: OBJECT</b>	The object is not suitable for shooting.	Check if the object is white and change the object if required.
<b>AUTO WHITE A (B) ERROR: OVER LIGHT</b>	The amount of incident light is too high.	Check if a strong light source, such as the sun, is shining into the camera either directly or as a result of a reflection caused by the object.
	The color temperature conversion filter is not set properly.	Set the color temperature conversion filter to the correct position.
<b>AUTO BLACK LENS NOT CLOSED?</b>	The lens will not close for auto black-balance adjustment.	Set the camera so that the lens can be closed.
<b>AUTO BLACK ERROR!</b>	Auto black adjustment is not working properly.	Check the setups of the RM-HP790DU/RM-HP790DE and camera again.

# Operable Camera Features

Function		GY-HM790 series ✓: Available -: Not available	
IRIS	AUTO IRIS	✓	
	AI LEVEL	✓	
	MANUAL IRIS	✓	
	IRIS LEVEL	✓	
MASTER BLACK		✓	
WHITE	MODE		
	MANUAL	✓	
	PRESET	✓	
	AUTO1	✓	
	AUTO2	✓	
	FAW	✓	
	AUTO		
	SET	-	
	WHITE	✓	
	MANUAL LEVEL		
	R, B	✓	
	WHITE PAINT		
	R, B	✓	
	FAW	✓	
GAIN	-3 dB	-	
	0 dB	✓	
	3 dB	✓	
	6 dB	✓	
	9 dB	✓	
	12 dB	✓	
	15 dB	✓	
	18 dB	✓	
	24 dB	-	
	ALC + EEI	✓	
	ALC	✓	
	VARIABLE	-	
	LOLUX	OFF	-
		ON	-
SHUTTER* <sup>1</sup>	OFF	✓	
	1/100 or 1/120	✓* <sup>2</sup>	
	1/250	✓	
	1/500	✓	
	1/1000	✓	
	1/2000	✓	
	1/4000	✓	
	1/10000	✓	
VARIABLE	-		
TALLY		✓	
PREVIEW		✓	
CALL		✓	

Function		GY-HM790 series ✓: Available -: Not available
BARS	OFF	✓
	ON	✓
DETAIL (CONTOUR)	OFF	✓
	ON	✓
DETAIL LEVEL		✓
DETAIL V/H		✓
DETAIL FRQ* <sup>1</sup>	LOW	✓
	MIDDLE	✓
	HIGH	✓
	AUTO	-
AUTO KNEE	OFF	✓
	ON	✓
KNEE POINT		✓
COLOR MATRIX	OFF	-
	ON	-
GAMMA	OFF	✓
	ON	✓
GAMMA LEVEL		✓
BACK		✓
ASPECT RATIO		-
DNR	OFF	✓
	ON	✓
DNR LEVEL		-
SMOOTH TRANS	OFF	✓
	ON	✓
FULL AUTO	OFF	✓
	ON	✓
SD H PHASE		-
HD H PHASE		✓* <sup>2</sup>
SC COARSE		-
SC FINE		-

\*1 : Equivalent to [DTL H FREQ] on the camera.

\*2 : Changes depending on the Video Format.

## Operation of Connected Camera

When RM-HP790DU/RM-HP790DE is connected to a camera, all features that are available on RM-HP790DU/RM-HP790DE can only be controlled by RM-HP790DU/RM-HP790DE, and control of these features using the camera is disabled.

Switches on the camera that are disabled, as well as disabled menu items are as follows.

### Standard connection of RM-HP790DU/RM-HP790DE (Connection of 2 units)

- GAIN
- SHUTTER\*1
- WHT.BAL
- FULL AUTO\*2
- User 1, 2 and 3 with the following features assigned
  - BARS
  - B.STRETCH1-5
  - B.COMPRESS1-5
  - AE LEVEL +
  - AE LEVEL -

\*1 : [SHUTTER] will also be disabled if the setting is "VARIABLE" or below "1/30" (When Frame rate is "60/24") or "1/25" (When Frame rate is "50").

\*2 : Setting is configured from RM-HP790DU/RM-HP790DE regardless of the status of the [FULL AUTO] switch.

### Menu items that are disabled

Menu Page	Function	Menu Display on RM-HP790DU/RM-HP790DE
CAMERA OPERATION	AE LEVEL	REMOTE
	SMOOTH TRANS	
	BARS	
CAMERA PROCESS [1/2]	MASTER BACK	REMOTE
	DETAIL	
	DETAIL V/H	
	DETAIL FRQ	
CAMERA PROCESS [2/2]	SKIN DETECT	REMOTE
	BACK	
	KNEE	
	LEVEL	
ADVANCED PROCESS	DNR	[OFF]*3
	CINEMA	
	GAMMA	
	LEVEL	
WHITE BALANCE	WHITE PAINT R	[STANDARD]*4
	WHITE PAINT B	
GENLOCK	[CINEMA]*4	REMOTE
	[FILMOUT]*4	
	SD H PHASE	
	HD H PHASE	
	SC COARSE	
	SC FINE	

\*3 : [CINEMA] is forcibly set to "OFF". To adjust MATRIX, make use of the menu on the camera.

\*4 : [GAMMA] is fixed at the menu setting value of the camera before connecting to the remote control. However, when the menu setting value is "OFF", [GAMMA] will be forcibly set to "STANDARD".



# Troubleshooting

Symptom		Check Points	Action
Video troubles	Colors in the monitor screen are abnormal. (During genlocking)	<ul style="list-style-type: none"> <li>Is the SC phase adjusted properly?</li> </ul>	☞ P 12
	Synchronization is not possible.	<ul style="list-style-type: none"> <li>Are the Tri-level sync signal or BB signals applied to the [GENLOCK INPUT] connectors?</li> <li>Is the VTR playback signal supplied directly without passing through a TBC?</li> </ul>	☞ P 12
Control troubles	Pressing the corresponding button cannot start the operation. “<EXT>” is displayed on the LCD.	<ul style="list-style-type: none"> <li>Functions that are not available on the camera cannot be controlled. ⇒ Check the camera functions again.</li> </ul>	—
	The LCD display keeps on displaying “NOW INITIALIZING JUST A MOMENT”.	<ul style="list-style-type: none"> <li>Are cables connected properly?</li> <li>Is the power switch of the camera set to ON?</li> </ul>	☞ P 8 ☞ P 9 ☞ P 10
	The LCD display keeps on display “PLEASE CHECK THE CAMERA”.	<ul style="list-style-type: none"> <li>Are cables connected properly?</li> <li>Is the power switch of the camera set to ON? (When power of camera is turned off while RM-HP790DU/RM-HP790DE is on, “PLEASE CHECK THE CAMERA” will be displayed after about 20 seconds if RM-HP790DU/RM-HP790DE is operated. In addition, when turning on RM-HP790DU/RM-HP790DE while the power switch of camera is off, similar display will appear after about 30 seconds.)</li> </ul>	☞ P 8 ☞ P 9 ☞ P 10
	LCD display shows “---”.	<ul style="list-style-type: none"> <li>The connected camera does not have the assigned function. Check the camera functions again and assign the proper functions to the [F1] to [F4] buttons.</li> </ul>	☞ P 25
	white balance adjustment cannot be started.	<ul style="list-style-type: none"> <li>Is the [W. BAL] switch set to “A” or “B”?</li> <li>Is FAS or FAW ON (which is indicated by the lighting of the [AUTO] light)?</li> </ul>	☞ P 18
	The white balance adjustment will not complete.	<ul style="list-style-type: none"> <li>Are the color temperature filters and lighting conditions appropriate?</li> <li>Does the object have colors?</li> </ul>	☞ P 18
	The tally lamp does not light.	<ul style="list-style-type: none"> <li>Is the tally system of the RM-HP790DU/RM-HP790DE compatible with that of the camera system? The RM-HP790DU/RM-HP790DE has been set to the voltage supply at the factory. If it is required to use the [TALLY] input in the contact supply mode, the setting of the internal circuitry should be changed ; consult the nearest JVC-authorized service agent.</li> </ul>	☞ P 14
	Incorrect operation even when FAS button is ON.	<ul style="list-style-type: none"> <li>Is the Studio cable of KA-M790G pulled out or loose? ⇒ Connect the cable properly.</li> </ul>	—
	“E.02” will be displayed on RM-LP25U	<ul style="list-style-type: none"> <li>Are cables connected properly?</li> <li>Is the power switch of the camera set to ON? (When power of camera is turned off while RM-HP790DU/RM-HP790DE/RM-LP25U is on, similar display will appear after about 10 seconds.)</li> </ul>	☞ P 8 ☞ P 9 ☞ P 10
	[OPERATE] button of RM-LP25U keeps blinking.	<ul style="list-style-type: none"> <li>Are cables connected properly?</li> <li>Is the power switch of the camera set to ON? (When turning on RM-HP790DU/RM-HP790DE/RM-LP25U while the power switch of camera is off, the [OPERATE] button will keep blinking.)</li> </ul>	☞ P 8 ☞ P 9 ☞ P 10

# Specifications

## Output Signals

Composite video signal	: 1 V (p-p), 75 Ω, 1 output
R/G/B signals	: 0.7 V (p-p), 75 Ω, x1 each (without sync)
Y/PB/PR signals	
Y	: 1 V (p-p), 75 Ω
PB	: 0.7 V (p-p), 75 Ω
PR	: 0.7 V (p-p), 75 Ω (75% color bar)
Intercom	
RM-HP790DU	: 2-line system, -10 dB, 220 Ω, unbalanced RTS (The RTS terminals are not designed to accept a voltage supply.)
RM-HP790DE	: 2-line system, -10 dB, 600 Ω, balanced
Remote	: 5.0 V (p-p)
[HD/SD SDI OUTPUT]	
HD SDI	: SMPTE292M-compliant Signal level: 0.8 V(p-p) Max transfer distance: 100 m
SD SDI	: SMPTE259M-compliant Signal level: 0.8 V(p-p) Max transfer distance: 100 m
TC	: Supported
AUDIO	: Supported
No. of output connectors	: 2 outputs

## Input Signals

Tally	
RM-HP790DU	: Contact supply : DC 10 V, 3 mA or more
RM-HP790DE	: Voltage supply : AC 6.3 V, DC 5 to 24 V Non-switching between AC and DC
Intercom	
RM-HP790DU	: 2-line system, -10 dB, 220 Ω, unbalanced RTS (The RTS terminals are not designed to accept a voltage supply.)
RM-HP790DE	: 2-line system, -10 dB, 600 Ω, balanced
Remote	: 5.0 V (p-p)
[HD/SD SDI INPUT]	
HD SDI	: SMPTE292M-compliant 720p/60/50 1080i/60/50
SD SDI	: SMPTE259M-compliant 480i/60 576i/50
No. of output connectors	: 1 input
[GENLOCK INPUT]	
HD	: Y signal: 1 Vp-p, 75 Ω or Tri-level sync signal: 0.6 V(p-p), 75 Ω loop-through output
SD	
RM-HP790DU	: VBS signal: 1 V(p-p), 75 Ω or Black Burst signal: 0.43 V(p-p), 75 Ω loop-through output
RM-HP790DE	: VBS signal: 1 V(p-p), 75 Ω or Black Burst signal: 0.45 V(p-p), 75 Ω loop-through output
[AUX VIDEO INPUT]	
SD	: VBS signal: 1 V(p-p), 75 Ω loop-through output

## General

### Input Voltage

- RM-HP790DU : AC 120V, 60 Hz
- RM-HP790DE : AC 230V, 50 Hz

### Power Consumption (Consumed current)

- RM-HP790DU : 80 W  
(GY-HM790 series+KA-M790G+VF-HP790G+RM-LP25U+Headset)
- RM-HP790DE : 0.4 A  
(GY-HM790 series+KA-M790G+VF-HP790G+RM-LP25U+Headset)

Mass : Approx. 5.5 kg

### Allowable operating temperature

: -5 °C to 40 °C (23 °F to 104 °F)

### Allowable storage temperature

: -20 °C to 60 °C (-4 °F to 140 °F)

### Allowable operating humidity

: 30 %RH to 80 %RH

### Allowable storage humidity

: 85 %RH and below

## Accessories

- Power Cord (2.5 m) ..... 1
- Instructions ..... 1
- Warranty Card (RM-HP790DU only) ..... 1

## Dimensional Outline Drawing (Unit: mm)

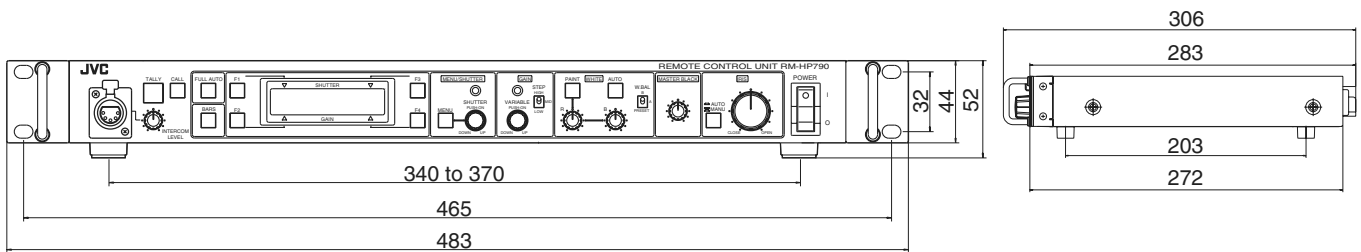

### RM-HP790DU

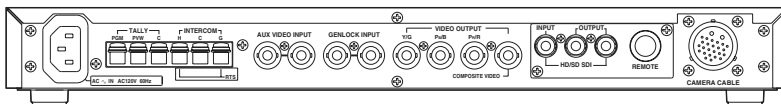

### RM-HP790DE

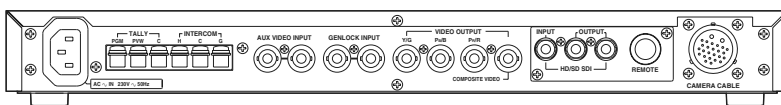

\* The specifications and appearance of this product are subject to changes for further improvement without prior notice.

RM-HP790DU/RM-HP790DE  
REMOTE CONTROL UNIT

---

**JVC**