

# JVC

## HD MEMORY CARD CAMERA RECORDER

---

### Detailed User Guide

# GY-HM70E

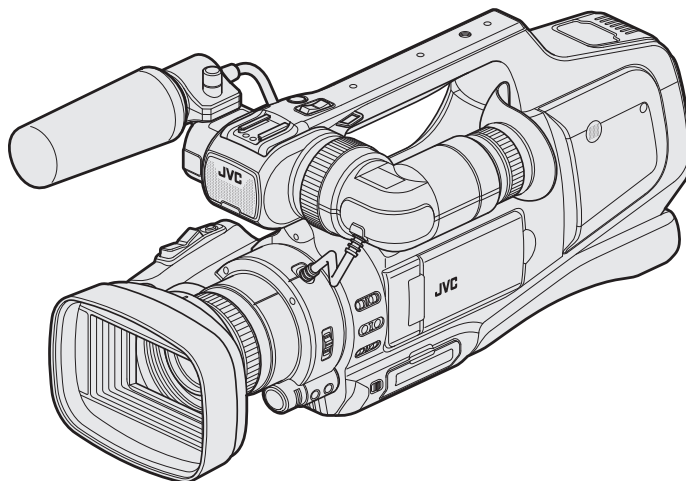

\* This illustration shows the GY-HM70E with an optional microphone.

## Table of Contents

### Getting Started

Verifying the Accessories .....	4
Charging the Battery Pack .....	5
Inserting an SD Card .....	6
Types of Usable SD Card .....	7
Using the Touch Screen .....	8
Adjusting the Touch Panel .....	8
Names of Buttons and Functions on the LCD Monitor .....	9
Turning On/Off the Power .....	11
Clock Setting .....	12
Resetting the Clock .....	12
Changing the Display Language .....	13
Viewing the Viewfinder/LCD Monitor .....	14
Adjusting the Grip Belt .....	14
Removing the Hood .....	14
Opening the Lens Cover .....	14
Preparing the Remote Control .....	15
Attaching the Headphones .....	15
Attaching the External Microphone .....	15
Tripod Mounting .....	15
Using this Unit Overseas .....	16
Charging the Battery Pack Overseas .....	16
Setting the Clock to Local Time when Traveling .....	16
Setting Daylight Saving Time .....	17
Optional Accessories .....	17

### Recording

Selecting Recording Mode .....	18
Selecting Intelligent Auto/Manual Recording Mode .....	18
Selecting Focus Mode .....	18
Selecting Video/Still Image Recording Mode .....	19
Taking Videos in Auto Mode .....	20
Capturing Still Images During Video Recording .....	23
Taking Still Images in Auto Mode .....	24
Zooming .....	26
Adjusting Focus Manually .....	27
Adjusting Focus by Using Focus Assist .....	27
Displaying Zebra Pattern .....	28
Adjusting Brightness Manually .....	29
Setting Backlight Compensation .....	29
Adjusting Shutter Speed .....	30
Adjusting Aperture .....	30
Setting White Balance .....	31
Shooting According to Scene (Subject) .....	32
Taking Close-up Shots .....	33
Capturing Subjects Clearly (TOUCH PRIORITY AE/AF) .....	34
Capturing Smiles Automatically (SMILE SHOT) .....	35
Setting SMILE% .....	36
Reducing Camera Shake .....	37
Slow-motion (High-speed) Recording .....	38
Recording at Intervals (TIME-LAPSE RECORDING) .....	39
Recording Automatically by Sensing Movements (AUTO REC) .....	40
Taking Group Shots (Self-timer) .....	41
Checking the Remaining Recording Time .....	43

### Playback

Playing Back Videos .....	45
Normal Playback .....	47
Checking the Recording Date and Other Information .....	48
DIGEST PLAYBACK .....	49
PLAYBACK PLAYLIST .....	50
PLAYBACK OTHER FILE .....	51
Playing Back Still Images .....	52
Slideshow Playback .....	53
Searching for a Specific Video/Still Image by Date .....	54
Connecting to and Viewing on TV .....	55

Connecting via the HDMI Connector .....	55
Connecting via the AV Connector .....	57
Playing Back a DVD or Blu-ray Disc Created on this Unit .....	58
Digest Playback on a Blu-ray or DVD Player .....	58

### Editing

Deleting Unwanted Files .....	59
Deleting the Currently Displayed File .....	59
Deleting Selected Files .....	59
Protecting Files .....	60
Protecting/Releasing Protection of the Currently Displayed File .....	60
Protecting/Releasing Protection of Selected Files .....	60
Capturing a Still Image in the Video during Playback .....	61
Capturing a Required Part in the Video (TRIMMING) .....	62
Creating Playlists from the Recorded Videos .....	63
Creating Playlists with Selected Files .....	63
Creating Playlists by Date .....	64
Editing Playlists .....	66
Deleting Playlists .....	68

### Copying

Creating Discs with a BD Writer (External Blu-ray Drive) .....	69
Preparing a BD Writer (External Blu-ray Drive) .....	69
Creating a Disc .....	70
Playing Back with a BD Writer (External Blu-ray Drive) .....	77
Creating Discs with a DVD Writer .....	77
Preparing a DVD Writer (CU-VD3) .....	78
Preparing a DVD Writer (CU-VD50) .....	78
Creating a Disc .....	79
Playing Back with a DVD Writer .....	83
Creating a Disc Using a Connected Blu-ray Recorder .....	84
Dubbing Files to a Disc by Connecting to a DVD Recorder .....	85
Dubbing Files to a VHS Tape by Connecting to a VCR .....	86
Using a USB External Hard Disk Drive .....	87
Preparing a USB External Hard Disk Drive .....	87
Copying All Files .....	88
Playing Back Files in the USB External Hard Disk Drive .....	90
Deleting Folders in the USB External Hard Disk Drive .....	90
Formatting the USB External Hard Disk Drive .....	91
Copying to Windows PC .....	92
List of Files and Folders .....	93
Copying to Mac Computer .....	94

### Menu Settings

Operating the Menu .....	95
Operating the Top Menu .....	95
Operating the Shortcut Menu .....	95
RECORD SETTING Menu (video) .....	96
SPECIAL RECORDING Menu (video) .....	100
RECORD SETTING Menu (still image) .....	101
SPECIAL RECORDING Menu (still image) .....	103
PLAYBACK SETTING Menu (video) .....	104
EDIT Menu (video) .....	104
PLAYBACK SETTING Menu (still image) .....	105
EDIT Menu (still image) .....	105
SETUP (video/still image) .....	106
CONNECTION SETTINGS (video/still image) .....	108
MEDIA SETTINGS (video/still image) .....	109

### Names of Parts ..... 110

### Indications on the LCD monitor ..... 112

### Troubleshooting

When the unit is not working properly .....	115
Battery Pack .....	116
Recording .....	116
Card .....	117

---

Playback .....	117
Editing/Copying .....	118
Computer .....	119
Screen/Image .....	119
Other Problems .....	120
Error Message? .....	121

---





**Maintenance .....** 123

---

**Specifications .....** 124

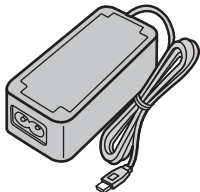
## Verifying the Accessories

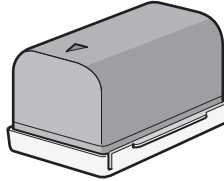
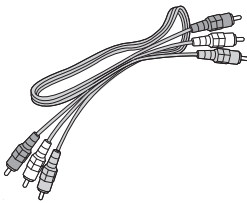
If any of the items are missing or defective, consult your JVC dealer or the nearest JVC service center.

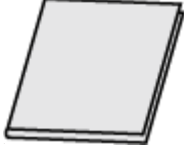
Illustration	Description
	<p>AC Adapter UIA324-1220 (1.2 m)</p> <ul style="list-style-type: none"> <li>Connects to this unit to charge the battery pack. It can also be used when recording or playing back videos indoors.</li> </ul>
	<p>Power Cord (1 m)</p> <ul style="list-style-type: none"> <li>Connect the power cord to the AC adapter.</li> </ul>
	<p>Battery Pack BN-VF823U (x1)</p> <ul style="list-style-type: none"> <li>Attaches to this unit to supply power.</li> </ul>
	<p>AV Cable (1 m)</p> <ul style="list-style-type: none"> <li>Connects this unit to a TV to play back recorded images on the TV.</li> </ul>
	<p>USB Cable (Type A - Mini Type B) (1 m)</p> <ul style="list-style-type: none"> <li>Connects this unit to a computer.</li> </ul>
	<p>CD-ROM</p> <ul style="list-style-type: none"> <li>Detailed User Guide is provided in PDF file.</li> </ul>
	<p>Basic User Guide</p> <ul style="list-style-type: none"> <li>Read well and keep in a safe place where it can be accessed easily when necessary.</li> </ul>

**Memo :**

- SD cards are sold separately.

“Types of Usable SD Card” (p. 7)

- When using the AC adapter overseas, please prepare a commercially available converter plug for the country or region of visit.

“Charging the Battery Pack Overseas” (p. 16)

## Charging the Battery Pack

Charge the battery pack immediately after purchase and when the remaining battery power is low.

The battery pack is not charged at the time of purchase.

- 1 Set the "STANDBY/ON OFF" switch to "OFF".

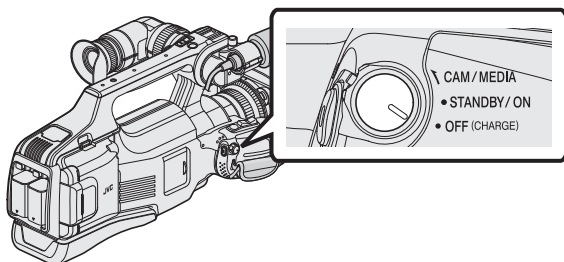

- 2 Attach the battery pack.

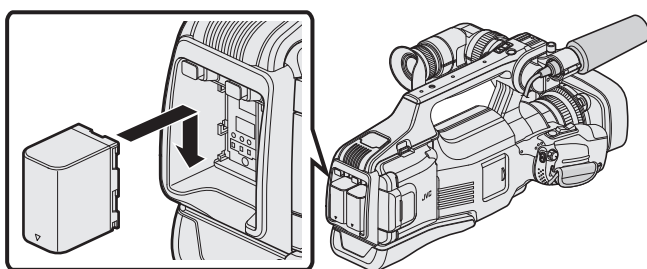

- Align the terminal of the battery pack with this unit.
- You can use this unit even if only one battery pack is attached.
- Either BATT.1 or BATT.2 can be charged.
- If two battery packs are attached, BATT.1 is charged first. After the charging of BATT.1 is completed, BATT.2 is charged. However, if BATT.1 is attached while BATT.2 is being charged, BATT.1 will be charged after the charging of BATT.2 is completed. Both battery packs cannot be charged at the same time.

- 3 Connect the AC adapter to the DC connector and plug in the power.

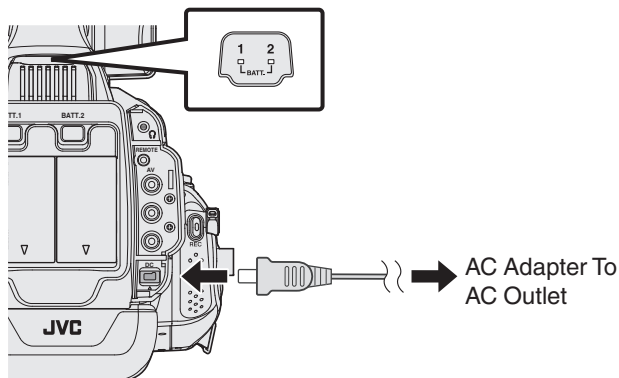

- The charging lamp blinks when charging is in progress. It goes out when charging is finished.

### Warning

- Make sure not to insert the battery pack in the wrong direction. It may cause damage to the unit and battery pack.

### Caution :

Be sure to use JVC battery packs.

- If you use any other battery packs besides JVC battery packs, safety and performance cannot be guaranteed.
- Charging time: Approx. 3 h 30 m (using supplied battery pack)  
The charging time is when the unit is used at 25°C. If the battery pack is charged outside the room temperature range of 10°C to 35°C, charging may take a longer time or it may not start.  
CHARGE lamp blinks 2 times in a slow cycle for notification if the battery charge does not start.
- If malfunctions (overvoltage, etc) occur, or if any battery manufactured other than by JVC is attempted for battery charge, charging stops. In these cases, the CHARGE lamp blinks quickly for notification.

Be sure to use the supplied AC adapter.

- If you use any other AC adapters besides the supplied AC adapter, malfunctions may occur.
- You can record or play back videos while the AC adapter is connected. (Battery charging cannot be performed during recording or playback.)  
Remove the battery when the unit is to be used for a long time.  
Performance of the battery may drop if it is left attached to the unit.

Rechargeable Batteries :

- When using the battery in a low temperature environment (10°C or below), the operating time may be shortened, or it may not function properly. When using this unit outdoors in the winter weather, warm the battery, such as by placing it in the pocket, before attaching it. (Keep away from direct contact with a warm pack.)
- Do not expose the battery to excessive heat, such as direct sunlight or fire.
- After removing the battery, store it in a dry place between 15°C to 25°C.
- Keep a 30 % battery level ( ) if the battery pack is not to be used for a long period of time. In addition, fully charge and then fully discharge the battery pack every 6 months, then continue to store it at a 30 % battery level ( ).

Memo :

- You can connect this unit to the AC adapter to record for long hours indoors.

### Detaching the Battery Pack

To detach the battery pack, press the battery lock release button, and slide the battery pack out of this unit.

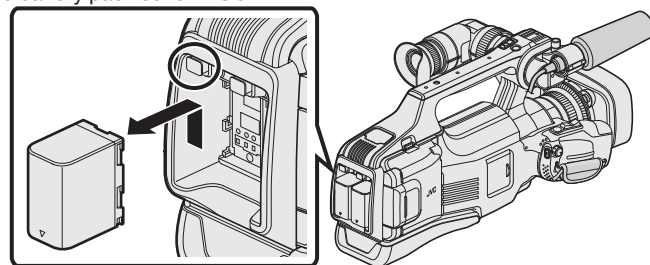

### Approximate Battery Charging Time (Using AC Adapter)

Battery Pack	Charging time
BN-VF815U	2 h 10 m
BN-VF823U (Provided)	3 h 30 m

- The charging time stated above is the time required when charging one battery pack.
- When the battery life is reached, the recording time becomes shorter even if the battery pack is fully charged.  
(Replace the battery pack with a new one.)

\* The charging time is when the unit is used at 25°C. If the battery pack is charged outside the room temperature range of 10°C to 35°C, charging may take a longer time or it may not start. The recordable and playable time may also be shortened under some usage conditions such as at low temperature. "Approximate Recording Time (Using Battery)" ( p. 44)

## Inserting an SD Card

Insert a commercially available SD card before recording.

This unit comes with two SD card slots. When two SD cards are inserted and “SEAMLESS RECORDING” in the “RECORD SETTING” menu is set to “ON”, recordings can be continued on the other card even if one card is full or error occurs on one card.

“Types of Usable SD Card” (p. 7)

“Approximate Video Recording Time” (p. 44)

• By default, files are recorded to the SD card in slot A. To record to the SD card in slot B, change the “REC VIDEO TO SLOTS” or “REC STILL TO SLOTS” setting.

“REC VIDEO TO SLOTS” (p. 109)

“REC STILL TO SLOTS” (p. 109)

1 Set the “STANDBY/ON OFF” switch to “OFF”.

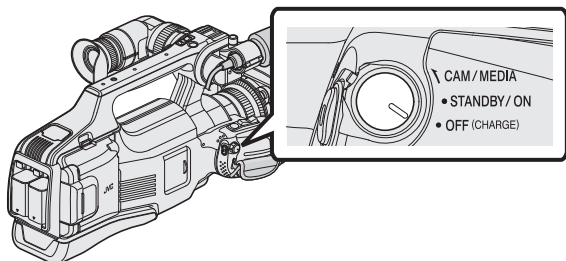

2 Open the door.

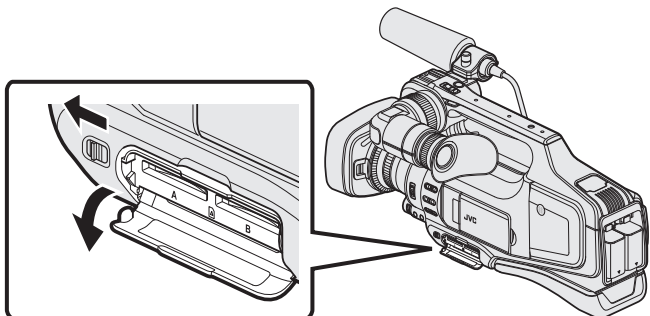

• Slide the “DOOR LOCK” lever to the left, and pull the door towards you.

3 Insert an SD card into slot A.

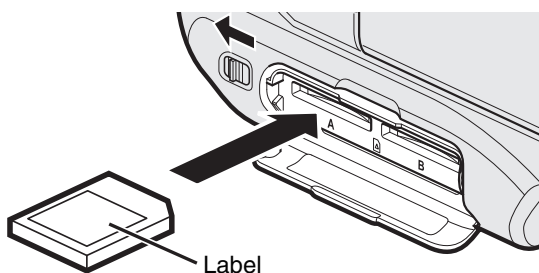

• Insert with the label facing upwards.

4 Close the door.

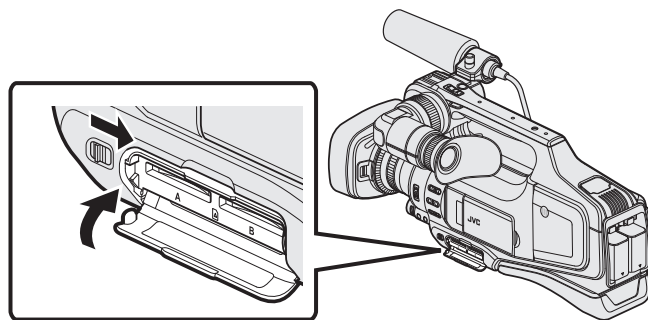

• After closing the door, slide the “DOOR LOCK” lever to the right to lock the door.

### Warning

- Make sure not to insert the card in the wrong direction. It may cause damage to the unit and card.
- Turn off the power of this unit before inserting or removing a card.
- Do not touch the metal contact area when inserting the card.

### Memo :

- When “SEAMLESS RECORDING” is set to “ON”, recordings can still be made to the other SD card without stopping when the remaining recording time on recording SD card runs out or when error occurs on the current recording media.

“SEAMLESS RECORDING (Seamless recording/Auto recovery recording)” (p. 98)

- Both videos and still images can be recorded on one SD card. It is recommended to confirm the video operation of the SD card before usage.
- To use cards that have been used on other devices, it is necessary to format (initialize) the card using “FORMAT SD CARD” from media settings.

“FORMAT SD CARD” (p. 109)

### Removing the Card

Push the SD card inward once, then pull it out straight.

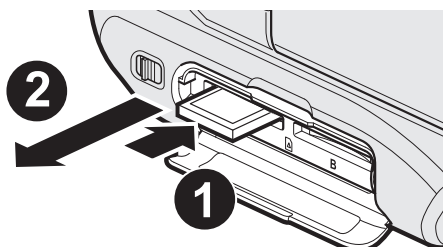

## Types of Usable SD Card

The following SD cards can be used on this unit.

Operations are confirmed on the SD cards from the following manufacturers.

- Panasonic
- TOSHIBA
- SanDisk

### SD Card



- This unit supports 256 MB to 2 GB SD cards.
- Use a Class 4 or higher compatible SD card (2 GB) for video recording.

### SDHC Card



- Use a Class 4 or higher compatible SDHC card (4 GB to 32 GB) for video recording.

### SDXC Card



- Use a Class 4 or higher compatible SDXC card (Max. 128 GB) for video recording.

### Memo :

- Using SD cards (including SDHC/SDXC cards) other than those specified above may result in recording failure or data loss.
- This unit is not guaranteed to operate with all SD cards. Some SD cards may not work due to specification changes, etc.
- To record videos with "VIDEO QUALITY" set to "UXP", use of a Class 6 compliant SDHC/SDXC card is recommended.
- When recording in progressive format (50p), Class 6 or higher is required.
- Class 4 and Class 6 are guaranteed to have a minimum transfer rate of 4 MB/s and 6 MB/s respectively during reading or writing of data.
- You can also use a Class 10 compliant SDHC/SDXC card.
- Both videos and still images can be recorded on one SD card. It is recommended to confirm the video operation of the SD card before usage.
- To protect the data, do not touch the terminals of the SD card.
- UHS-I SDHC/SDXC cards can be used in the same manner as standard SDHC/SDXC cards.  
UHS Speed Class is not supported.

## When your computer cannot recognize the SDXC card

Confirm and update the OS of your computer.

<b>Windows XP</b>	<ul style="list-style-type: none"> <li>• Make sure that the operating system version is SP2 or higher.</li> <li>• Download and install the updating program (KB955704) from the following URL. <a href="http://www.microsoft.com/downloads/details.aspx?familyid=1CBE3906-DDD1-4CA2-B727-C2DFF5E30F61&amp;displaylang=ja">http://www.microsoft.com/downloads/details.aspx?familyid=1CBE3906-DDD1-4CA2-B727-C2DFF5E30F61&amp;displaylang=ja</a></li> </ul>
<b>Windows Vista</b>	<ul style="list-style-type: none"> <li>• Make sure that the operating system version is SP1 or higher.</li> <li>• Download and install the updating program (KB975823) from the following URL. <a href="http://www.microsoft.com/downloads/en/details.aspx?FamilyID=2d1abe01-0942-4f8a-abb2-2ad529de00a1">http://www.microsoft.com/downloads/en/details.aspx?FamilyID=2d1abe01-0942-4f8a-abb2-2ad529de00a1</a></li> <li>• 32 bit version <a href="http://www.microsoft.com/downloads/en/details.aspx?FamilyID=7d54c53f-017c-4ea5-ae08-34c3452ba315">http://www.microsoft.com/downloads/en/details.aspx?FamilyID=7d54c53f-017c-4ea5-ae08-34c3452ba315</a></li> <li>• 64 bit version <a href="http://www.microsoft.com/downloads/en/details.aspx?FamilyID=73f766dd-7127-4445-b860-47084587155f">http://www.microsoft.com/downloads/en/details.aspx?FamilyID=73f766dd-7127-4445-b860-47084587155f</a></li> </ul>
<b>Windows 7</b>	Download and install the updating program (KB976422) from the following URL. <ul style="list-style-type: none"> <li>• 32 bit version <a href="http://www.microsoft.com/downloads/en/details.aspx?FamilyID=3ee91fc2-a9bc-4ee1-aca3-2a9aff5915ea">http://www.microsoft.com/downloads/en/details.aspx?FamilyID=3ee91fc2-a9bc-4ee1-aca3-2a9aff5915ea</a></li> <li>• 64 bit version <a href="http://www.microsoft.com/downloads/en/details.aspx?FamilyID=73f766dd-7127-4445-b860-47084587155f">http://www.microsoft.com/downloads/en/details.aspx?FamilyID=73f766dd-7127-4445-b860-47084587155f</a></li> </ul>
<b>Mac OS X 10.4 Tiger / Mac OS X 10.5 Leopard</b>	Not compatible.
<b>Mac OS X 10.6 Snow Leopard</b>	Update the OS version to 10.6.5 or later.

## Using the Touch Screen

Icon operation buttons, thumbnails, and menu items are displayed on the touch screen according to the mode in use.

- There are two ways to operate the touch screen, namely “tap” and “drag”. The following are some examples.

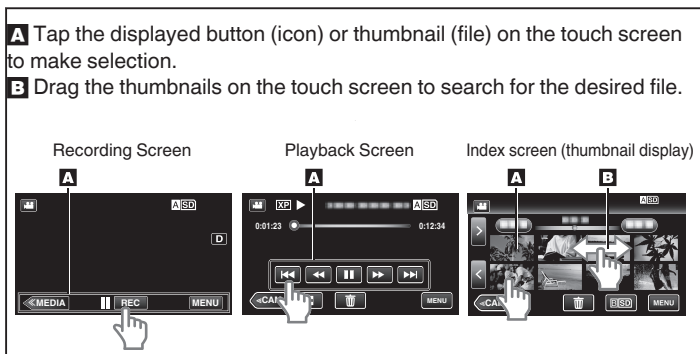

**Memo :**

- The touch screen of this unit is pressure-sensitive. When the touch screen does not respond smoothly, apply slightly more force to your fingertip.
- Tap the buttons (icons) on the touch screen accurately. The buttons may not respond if they are not tapped on the right area.
- Do not press or rub with excessive force.
- Do not operate the touch screen using an object with a sharp or hard tip.
- Pressing two or more places at a time may cause a malfunction.
- Perform “TOUCH SCREEN ADJUST” if the reactive area of the screen is misaligned with the touched area. (Adjust by lightly tapping with a corner of an SD card, etc. Do not press with an object with a sharp tip or do not press hard.)

“Adjusting the Touch Panel” (p. 8)

## Adjusting the Touch Panel

Adjusts the response position of the buttons on the touch screen.

- 1 Tap “MENU”.

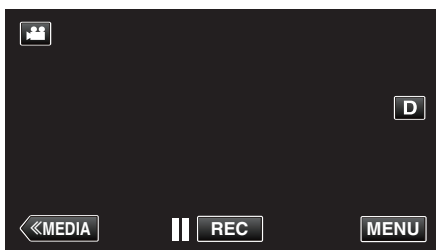

- 2 Tap “SETUP”.

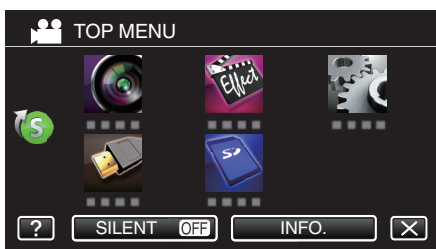

- 3 Tap “TOUCH SCREEN ADJUST”.

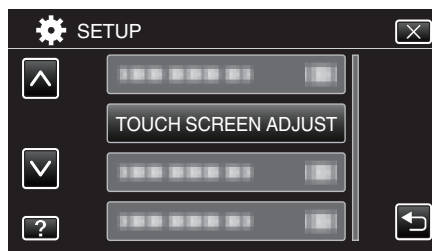

- The touch screen adjustment screen appears.

- 4 Tap “+”. (3 times in total)



- Keep tapping “+” as its position changes with every tap.
- If areas other than the “+” mark are tapped, errors will occur. Make sure to tap the “+” mark.

- 5 Tap “+” again to confirm the adjusted positions. (3 times in total)

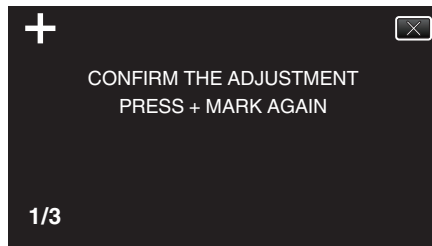

- Keep tapping “+” as its position changes with every tap.

- 6 Tap “OK”.

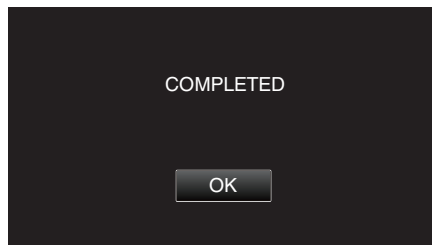

- Setting ends and returns to the menu screen.

**Caution :**

- Do not tap areas other than the “+” mark during touch screen adjustment (steps 4 - 5). Doing so may cause the touch screen to malfunction.

**Memo :**

- Adjust by lightly tapping with a corner of an SD card, etc.
- Do not press with an object with a sharp tip or do not press hard.





## Menu Screen (Recording Mode)

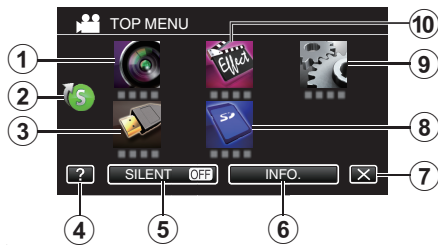

- 1** RECORD SETTING Menu  
"RECORD SETTING Menu (video)" (☞ p. 96)
- 2** Shortcut Menu  
"Operating the Shortcut Menu" (☞ p. 95)
- 3** CONNECTION SETTINGS Menu  
"CONNECTION SETTINGS (video/still image)" (☞ p. 108)
- 4** Help Button  
Tap the ? (help) button and item to display descriptions.
- 5** SILENT Button  
"Using the Silent Mode" (☞ p. 22)
- 6** INFO. Button  
"Checking the Remaining Recording Time" (☞ p. 43)
- 7** Close Button  
Exit the menu.
- 8** MEDIA SETTINGS Menu  
"MEDIA SETTINGS (video/still image)" (☞ p. 109)
- 9** SETUP Menu  
"SETUP (video/still image)" (☞ p. 106)
- 10** SPECIAL RECORDING Menu  
"SPECIAL RECORDING Menu (video)" (☞ p. 100)

## Menu Screen (Playback Mode)

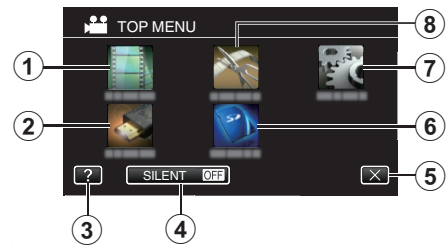

- 1** PLAYBACK SETTING Menu  
"PLAYBACK SETTING Menu (video)" (☞ p. 104)  
"PLAYBACK SETTING Menu (still image)" (☞ p. 105)
- 2** CONNECTION SETTINGS Menu  
"CONNECTION SETTINGS (video/still image)" (☞ p. 108)
- 3** Help Button  
Tap the ? (help) button and item to display descriptions.
- 4** SILENT Button  
"Using the Silent Mode" (☞ p. 22)
- 5** Close Button  
Exit the menu.
- 6** MEDIA SETTINGS Menu  
"MEDIA SETTINGS (video/still image)" (☞ p. 109)
- 7** SETUP Menu  
"SETUP (video/still image)" (☞ p. 106)
- 8** EDIT Menu  
"EDIT Menu (video)" (☞ p. 104)  
"EDIT Menu (still image)" (☞ p. 105)

## Turning On/Off the Power

### Turning On the Power

- To use the battery, refer to “Charging the Battery Pack” (☞ p. 5).

#### ■ When the AC adapter is connected

- 1 Connect the AC adapter to the “DC” terminal

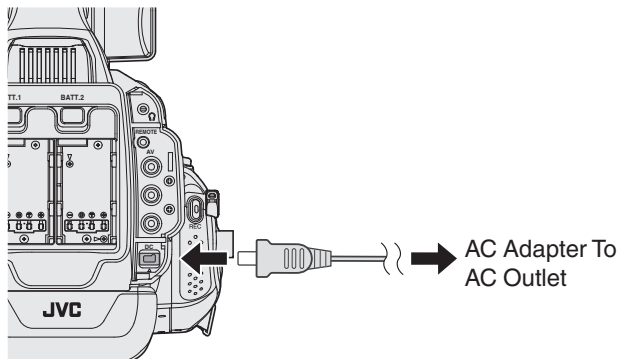

- 2 Set the “STANDBY/ON OFF” switch to “ON”.

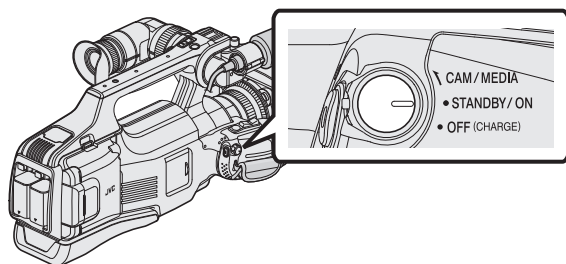

- The camera recorder starts up in Camera mode.
- The camera recorder always start up in Camera mode when the power is turned on.

#### ■ “CAM/MEDIA” operation mode and lamp status

Use the “CAM/MEDIA” operation mode selection switch to switch to a different mode. The “CAM” lamp and “MEDIA” lamp change as below.

Mode	“CAM” lamp	“MEDIA” lamp
During Camera mode	Lights up in red	Light goes out
During Media mode	Light goes out	Lights up in red

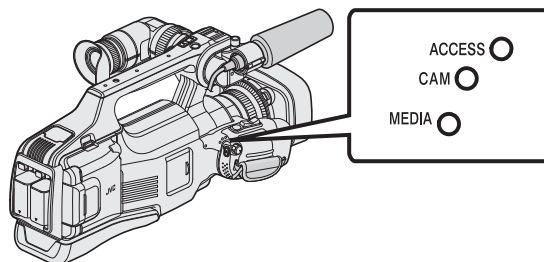

- To switch to the Media mode, turn the “CAM/MEDIA” selection switch, or press the “CAM/MEDIA” button.  
(You can also use the “<<CAM/<<MEDIA” button on the touch screen.)

### Turning Off the Power

- 1 Set the “STANDBY/ON OFF” switch to “OFF”.

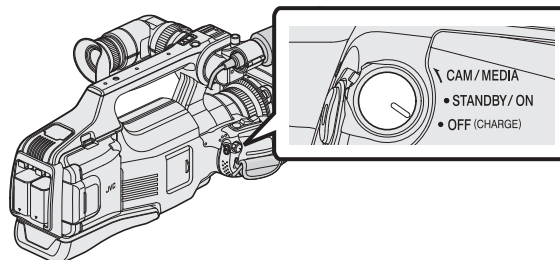

#### ■ Auto power off feature

If the unit is running on battery alone, and “AUTO POWER OFF” in the common menu is set to “ON”, the unit will turn off automatically if it is not operated or does not operate for 5 minutes.  
“AUTO POWER OFF” (☞ p. 107)

#### Memo :

- When both the battery and AC adapter are connected, power from the AC adapter connection will be used. As such, the “AUTO POWER OFF” function will not have any effect.

## Clock Setting

“SET DATE/TIME!” appears when you turn on this unit for the first time after purchase.

Set the clock before recording.

- 1 Set the “STANDBY/ON OFF” switch to “ON”.

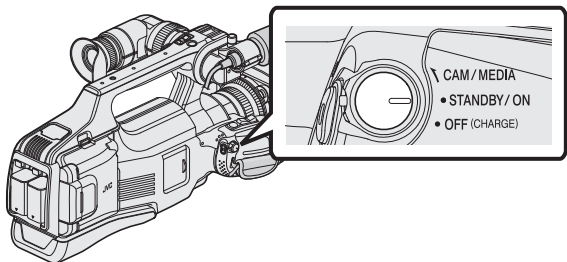

- 2 Open the LCD monitor.

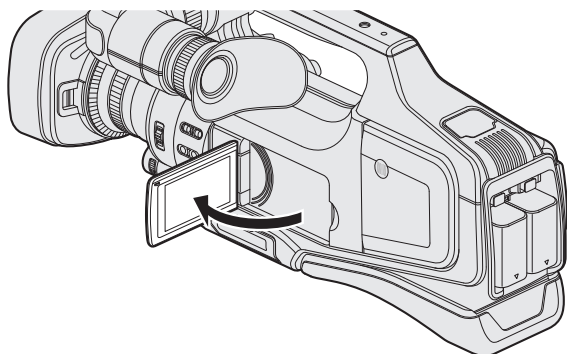

- 3 Tap “YES” when “SET DATE/TIME!” is displayed.

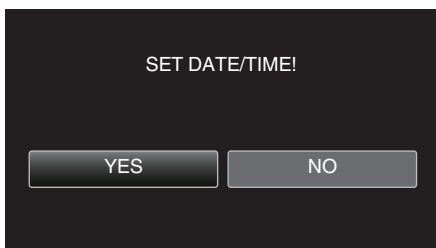

- 4 Set the date and time.

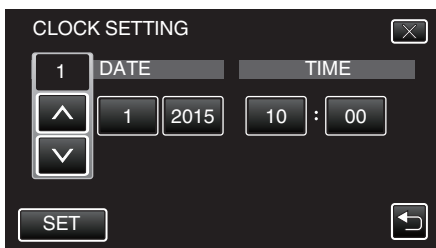

- When the year, month, day, hour, or minute item is tapped, “^” and “v” will be displayed.
- Tap ^ or v to adjust the year, month, day, hour, and minute.

- 5 After setting the date and time, tap “SET”.

- 6 Select the region where you live and tap “SAVE”.

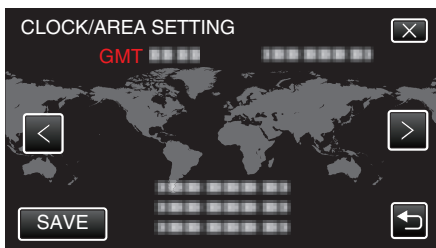

- Time difference between the selected city and the GMT (Greenwich Mean Time) is displayed.
- Tap <or> to select the city name.

### Memo :

- The clock can be reset again later.
- “Resetting the Clock” (p. 12)
- When using this unit overseas, you can set it to the local time for recording. “Setting the Clock to Local Time when Traveling” (p. 16)
- If “SET DATE/TIME!” appears after the clock has been set, the internal clock battery is drained. For details on replacing the battery, please consult the dealer from which the camera recorder is purchased, or your nearest service center.

### Resetting the Clock

Set the clock with “CLOCK ADJUST” from the menu.

- 1 Tap “MENU”.

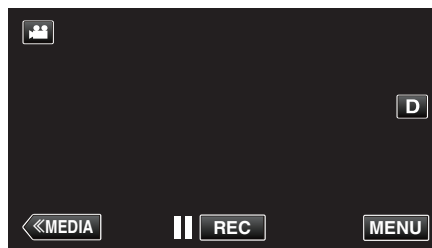

- 2 Tap “SETUP”.



- 3 Tap “CLOCK ADJUST”.

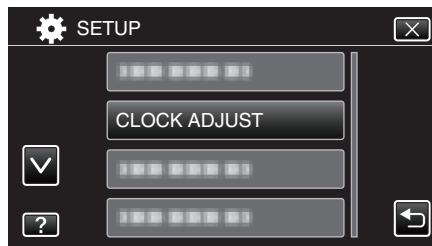

- Tap ^ or v to scroll the screen.

- 4 Tap “CLOCK SETTING”.

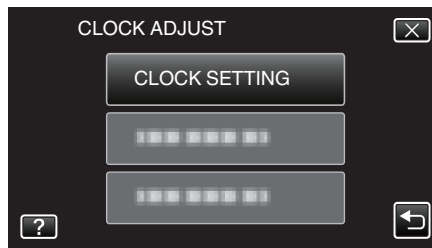

- 5 Set the date and time.

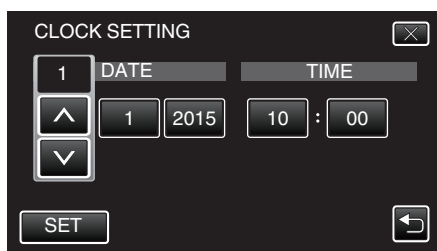

- When the year, month, day, hour, or minute item is tapped, “^” and “v” will be displayed.
  - Tap ^ or v to adjust the year, month, day, hour, and minute.
- 6 After setting the date and time, tap “SET”.
- 7 Select the region where you live and tap “SAVE”.

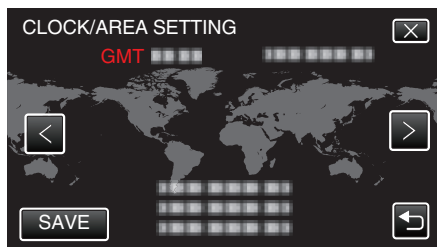

- Time difference between the selected city and the GMT (Greenwich Mean Time) is displayed.
- Tap <or> to select the city name.

## Changing the Display Language

The language on the display can be changed.

- 1 Tap “MENU”.

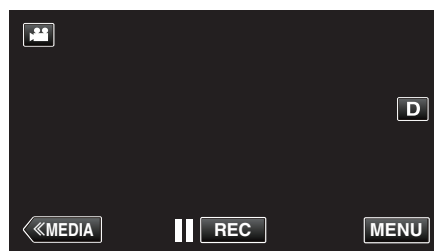

- 2 Tap “SETUP”.



- 3 Tap “LANGUAGE”.

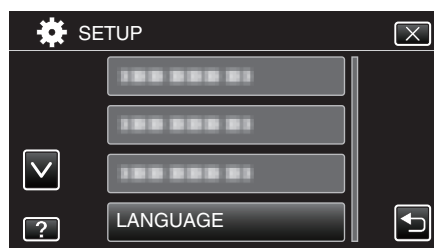

- Tap ^ or v to scroll the screen.

- 4 Tap to the desired language.



- Tap ^ or v to scroll the screen.

### Viewing the Viewfinder/LCD Monitor

You can monitor video images on this camera recorder using the viewfinder or LCD monitor.

#### ■ Viewing with the viewfinder

- 1 Adjust the viewfinder to an easy-to-see position.
- 2 Turn the eyepiece focus lever to adjust the focus.

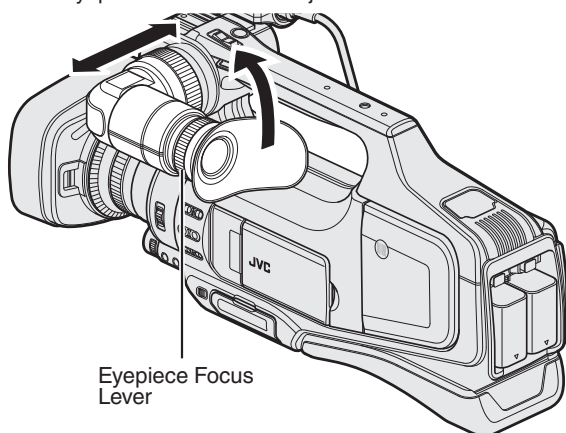

#### ■ Viewing on LCD monitor

- 1 Open the LCD monitor.
- 2 Adjust the LCD monitor to an easy-to-see position.

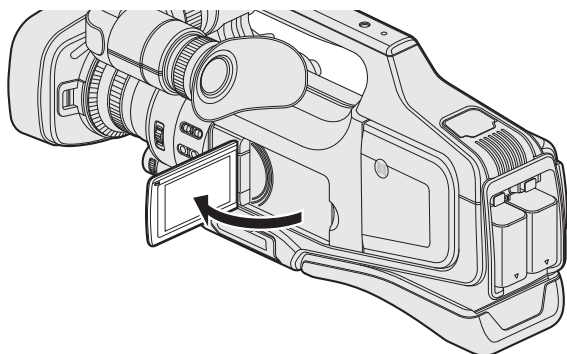

#### Memo :

- While the LCD monitor is opened, there will be no image display on the viewfinder.

#### ■ Adjusting the brightness of LCD monitor

Set the brightness using "MONITOR BRIGHTNESS" in the "SETUP" menu. "MONITOR BRIGHTNESS" (p. 106)

### Adjusting the Grip Belt

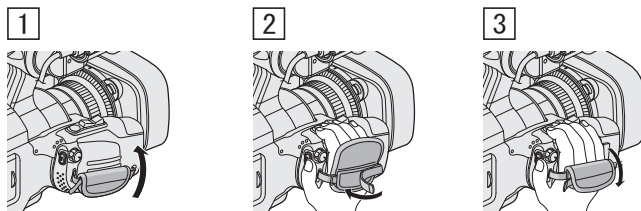

- 1 Open the pad.
- 2 Adjust the length of the belt
- 3 Close the pad.

#### Caution :

- Be sure to fasten the grip belt properly. If the belt is loose, this unit may drop and result in injuries or damages.

### Removing the Hood

Remove the hood when attaching a filter, teleconverter or wide converter to the front of the lens.

- Press and hold the release button on the back of the hood, turn the hood in the anti-clockwise direction to remove it.

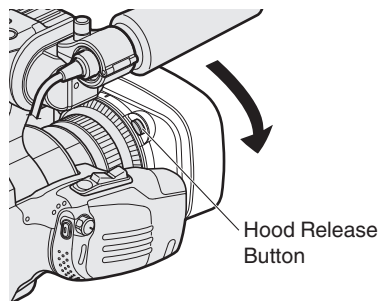

- To attach a hood, press it against the lens, and turn it in the clockwise direction.

### Opening the Lens Cover

Use the lens cover switch to open or close the lens cover. Before shooting, open the lens cover.

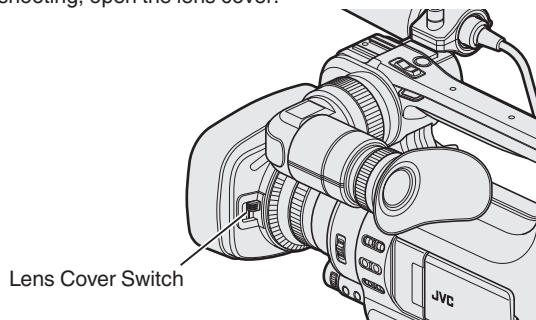

#### Memo :

- When this camera recorder is not in use, close the lens cover to protect the lens.
- Do not press against the lens cover with force. Doing so may damage the lens or the cover.

## Preparing the Remote Control

The functions of the camera recorder can be configured using a wired remote control.

- 1 Connect a wired remote control to the camera recorder.

Connect the wired remote control (sold separately) to the "REMOTE" jack of this camera recorder.

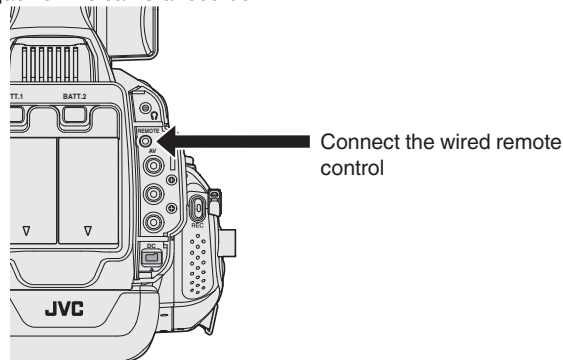

- 2 Turn on the power of the camera recorder.

### Caution :

- Turn off the power of the camera recorder when connecting a wired remote control.

## Attaching the Headphones

You can attach optional headphones to this unit.

- 1 Connect the headphones to the headphones connector.

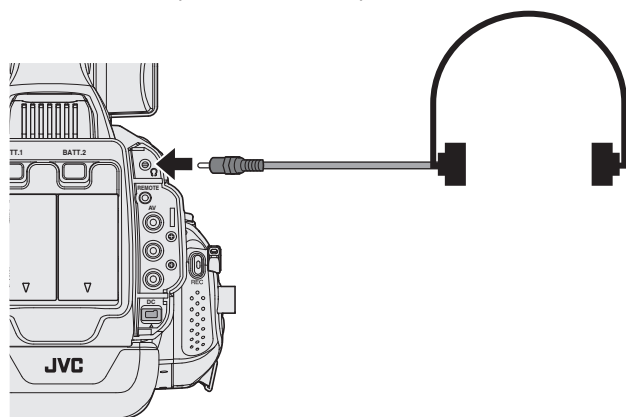

### Memo :

- The volume level of the headphones can be adjusted using the "ADJ." dial.
- The built-in speaker is usable only in the Media mode. Audio is not output from the built-in speaker during Camera mode.
- Audio level in the Camera mode and Media mode can be adjusted separately.
- When in the Media mode, the volume of the headphone and speaker are adjusted at the same time.
- The built-in speaker cannot be used when the headphone jack is connected.

## Attaching the External Microphone

You can attach a microphone (optional) to the microphone holder.

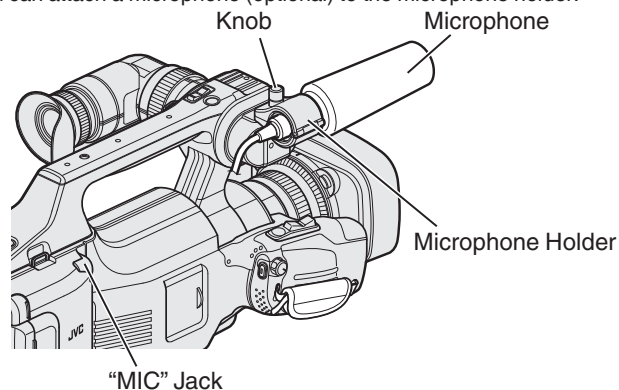

- 1 Turn the knob on the microphone holder anticlockwise to loosen it and open the microphone holder.
- 2 Place the microphone in the microphone holder.
- 3 Turn the knob on the microphone holder clockwise to secure the microphone.
- 4 Connect the cable of the microphone to the "MIC" jack.

### Memo :

- Phantom microphones are not supported. Use a microphone that supports plug-in power.

## Tripod Mounting

This unit can be mounted on a tripod (or monopod). This is useful for preventing camera shake and recording from the same position.

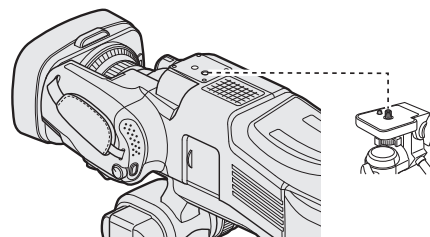

- To prevent this unit from falling off, check the tripod mounting screw holes and positioning holes on the unit carefully before mounting, and turn the screws until they are fastened firmly.

### Caution :

- To prevent injuries or damages which may result if this unit falls off, read the instruction manual of the tripod (or monopod) to be used and make sure that it is securely attached.

### Memo :

- It is recommended to use a tripod or monopod when recording in conditions prone to camera shake (such as in dark places or when zoomed to the telephoto end).
  - Set the image stabilizer to "OFF" when using a tripod for shooting.
- "Reducing Camera Shake" (p. 37)

## Using this Unit Overseas

The shape of the power outlet varies according to countries and regions. To charge the battery pack, you need a converter plug that matches the shape of the outlet.

“Charging the Battery Pack Overseas” (p. 16)

Change the date and time display to the local time by selecting your travel destination in “AREA SETTING” of “CLOCK ADJUST”.

“Setting the Clock to Local Time when Traveling” (p. 16)

When “ON” is selected in “DST SETTING” of “CLOCK ADJUST”, the time is set 1 hour ahead.

“Setting Daylight Saving Time” (p. 17)

## Charging the Battery Pack Overseas

The shape of the power outlet varies according to countries and regions. To charge the battery pack, you need a converter plug that matches the shape of the outlet.

A	B	BF	C	O

North America	Europe	Oceania	Middle East
United States A	Iceland C	Australia O	Israel C
Canada A	Ireland C	Guam A	Iran C
Mexico A	United Kingdom B,BF	Tahiti C	Kuwait B,C
	Italy C	Tonga O	Jordan B,BF
Asia	Austria C	New Zealand O	
Japan A	Netherlands C	Fiji O	Africa
India B,C,BF	Canary Islands C		Algeria A,B,BF,C
Indonesia C	Greece C	Latin	Egypt B,BF,C
Singapore B,BF	Switzerland C	Argentina O	Guinea C
Sri Lanka B,C,BF	Sweden C	Colombia A	Kenya B,C
Thailand A,BF,C	Spain A,C	Jamaica A	Zambia B,BF
South Korea A,C	Denmark C	Chile B,C	Tanzania B,BF
China A,B,BF,C,O	Germany C	Haiti A	Republic of South Africa B,C,BF
Nepal C	Norway C	Panama A	Mozambique C
Pakistan B,C	Hungary C	Bahamas A	Morocco C
Bangladesh C	Finland C	Puerto Rico A	
Philippines A,BF,O	France C	Brazil A,C	
Vietnam A,C	Belgium C	Venezuela A	
Hong Kong Special Administrative Region B,BF	Poland B,C	Peru A,C	
Macau Special Administrative Region B,C	Portugal B,C		
Malaysia B,BF,C	Romania C		

## Setting the Clock to Local Time when Traveling

Change the date and time display to the local time by selecting your travel destination in “AREA SETTING” of “CLOCK ADJUST”.

Restore the region settings after you returned from the trip.

1 Tap “MENU”.

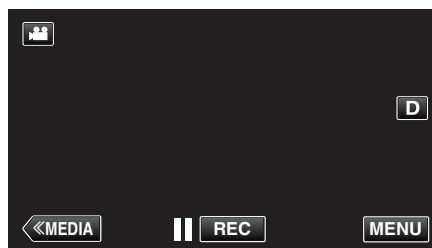

2 Tap “SETUP”.



3 Tap “CLOCK ADJUST”.

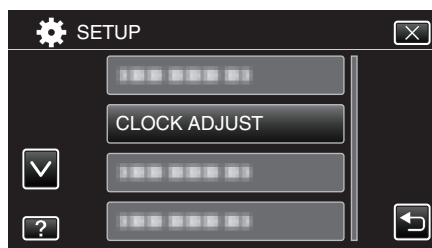

• Tap ^ or v to scroll the screen.

4 Tap “AREA SETTING”.

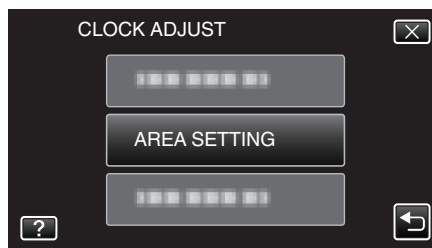

5 Select the area you are traveling to and tap “SAVE”.



• Time difference between the selected city and the GMT (Greenwich Mean Time) is displayed.

• Tap <or> to select the city name.

### Memo :

• Setting “AREA SETTING” changes the clock time such that time difference is accounted for.

After returning to your country, re-select the region that was set initially to restore the original clock settings.



## Setting Daylight Saving Time

When "ON" is selected in "DST SETTING" of "CLOCK ADJUST", the time is set 1 hour ahead.

1 Tap "MENU".

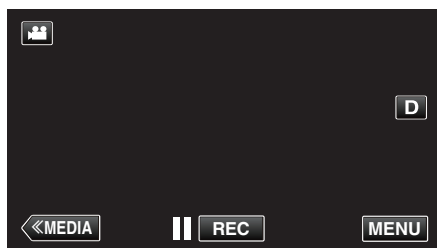

2 Tap "SETUP".

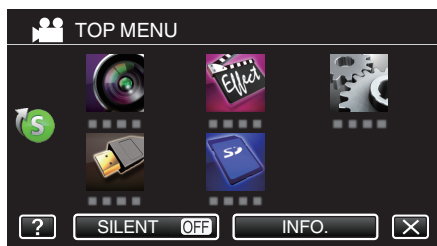

3 Tap "CLOCK ADJUST".

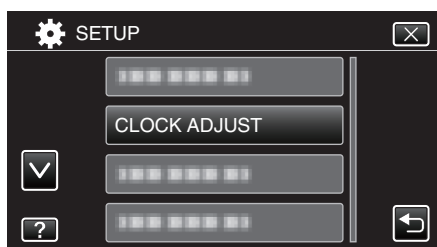

- Tap ^ or v to scroll the screen.

4 Tap "DST SETTING".

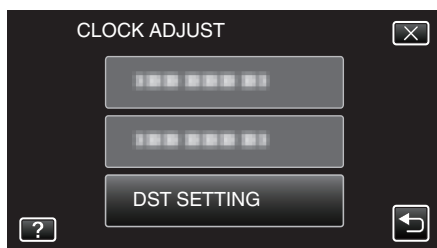

5 Tap "ON".

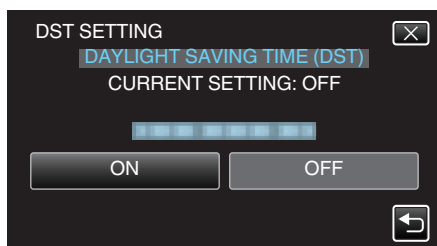

### Memo :

- What is daylight saving time?  
Daylight saving time is the system of setting the clock 1 hour ahead for a fixed period in summer.  
It is used mainly in the Western countries.
- Restore the daylight saving time settings after you returned from the trip.

## Optional Accessories

You can record for a longer time by using the optional battery pack.

Product Name	Description
Battery Pack BN-VF815U BN-VF823U	<ul style="list-style-type: none"> <li>• It can be used as a spare battery pack.</li> </ul>
Battery Charger • AA-VF8U	<ul style="list-style-type: none"> <li>• Enables the battery pack to be charged without using this unit.</li> </ul>

### Memo :

- The optional accessories above may not be supported in some regions.
- For more information, refer to the catalog.
- For details on the provided accessories, refer to "Verifying the Accessories".

"Verifying the Accessories" (p. 4)

## Approximate Recording Time (Using Battery)

Battery Pack	Actual recording time	Continuous recording time (Maximum Recording Time)
BN-VF815U	1 h 15 m	2 h 25 m
BN-VF823U (Provided)	1 h 50 m	3 h 30 m

- The recording time stated above is when one battery pack is used.
- The above are values when "MONITOR BRIGHTNESS" is set to "3" (standard) and "SYSTEM SELECT" is set to "50".
- The actual recording time is an estimate in case that such operations as zooming is used or recording is stopped repeatedly. It may be shorter in the actual usage.  
(It is recommended to prepare battery packs ready for three times the expected recording time.)
- When the battery life is reached, the recording time becomes shorter even if the battery pack is fully charged.  
(Replace the battery pack with a new one.)

## Selecting Recording Mode

### Selecting Intelligent Auto/Manual Recording Mode

There are two recording modes, namely Intelligent Auto and Manual.

#### ■ Selecting Intelligent Auto Mode

Pressing the "i.AUTO" button once displays the current recording mode. Pressing the "i.AUTO" button while the mode is being displayed changes the setting.

#### Memo :

You can also select the Intelligent Auto/Manual recording mode on the touch screen.

Tap **i.A.** (Intelligent Auto) or **M** (Manual) to display the selection screen. Tap the icon of the desired mode.

- 1 Press the "i.AUTO" button a few times to display "i.A.intelligent AUTO" on the screen.

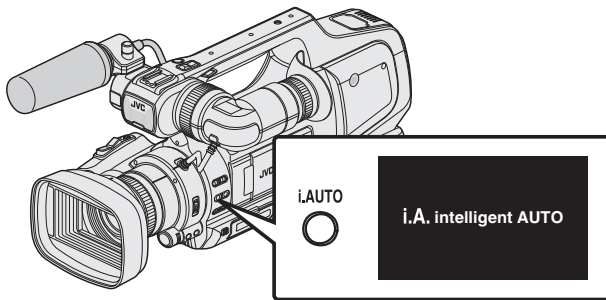

- Exposure, aperture, shutter speed, and white balance are adjusted automatically.
- During Intelligent Auto recording mode, you can also adjust the focus and brightness manually.

#### ■ Setting to the Manual shooting mode

- 1 Press the "i.AUTO" button a few times to display "M MANUAL" on the screen.

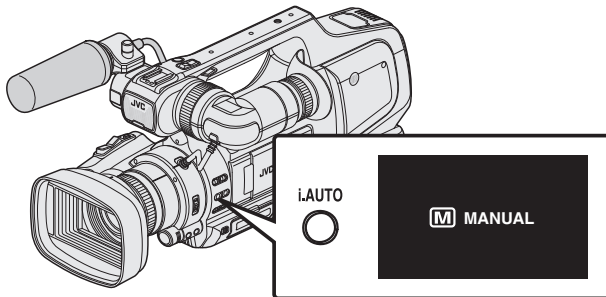

- Even when the Manual shooting mode is set, the aperture and shutter speed are adjusted automatically if their icons are not displayed.
- To adjust the shutter speed manually, press the "SHUTTER" button and change the value using the "ADJ." knob.  
"Adjusting Shutter Speed" (p. 30)
- To adjust the aperture manually, press the "IRIS" button and change the value using the "ADJ." knob.  
"Adjusting Aperture" (p. 30)

### Selecting Focus Mode

There are two ways to adjust the focus, namely Auto and Manual.

#### ■ Setting to the Auto Focus mode

- 1 Set the focus switch to "AF" to display the Auto Focus icon (AF) on the screen.

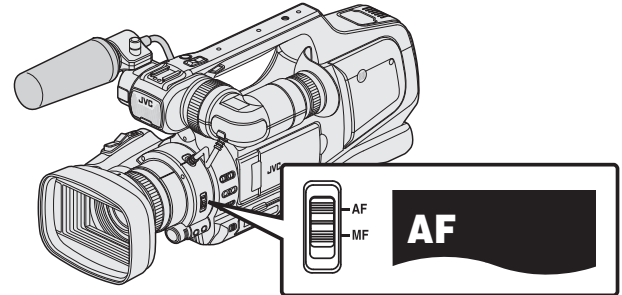

- Focus is adjusted automatically.

#### ■ Setting to the Manual Focus mode

- 1 Set the focus switch to "MF" to display the Manual Focus icon (MF) on the screen.

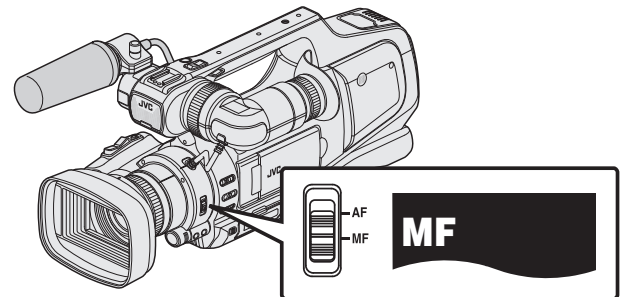

- Adjust the focus manually.  
"Adjusting Focus Manually" (p. 27)

## Selecting Video/Still Image Recording Mode

There are two recording modes, namely Video recording and Still Image recording.

### ■ Selecting Video Recording Mode

This unit enters into the video recording mode when the power is turned on. If the unit is in the still image recording mode, press the “MODE” button to switch to video recording mode.

- 1 Press the “MODE” button to display the icon (📹) of video recording mode on the screen

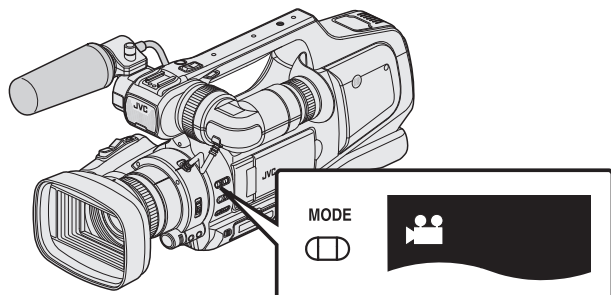

- You can start video recording.  
“Taking Videos in Auto Mode” (☞ p. 20)

### ■ Selecting Still Image Recording Mode

- 1 Press the “MODE” button to display the icon (📷) of still image recording mode on the screen

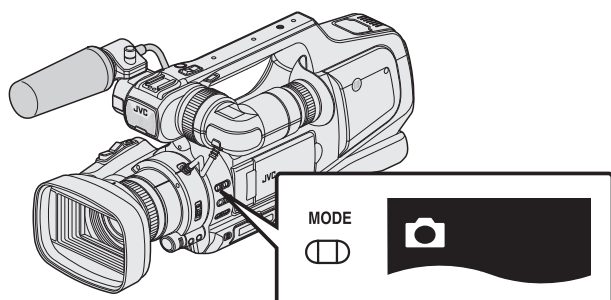

- You can start still image recording.  
“Taking Still Images in Auto Mode” (☞ p. 24)

### Memo :

You can also select the video/still image recording mode on the touch screen.

Tap 📹 (video) or 📷 (still image) to display the selection screen. Tap the icon of the desired mode.

The “MODE” button cannot be used to switch between the 50i mode (interlace) and 50p mode (progressive).

## Taking Videos in Auto Mode

You can record without worrying about the setting details by using the Intelligent Auto mode. Settings such as brightness will be adjusted automatically to suit the shooting conditions.

- Before recording an important scene, it is recommended to conduct a trial recording.

1 Open the lens cover.

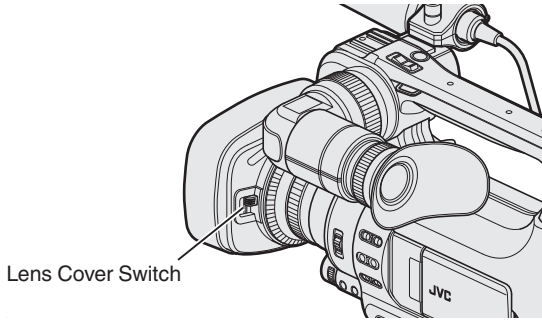

2 Set the "STANDBY/ON OFF" switch to "ON".

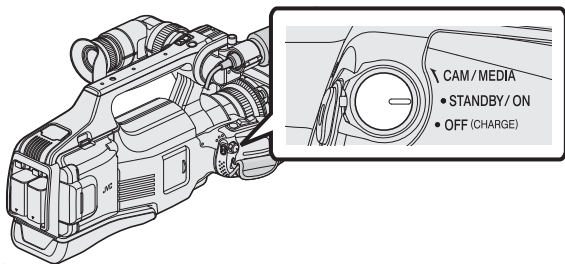

3 Check that the unit is in the video mode.

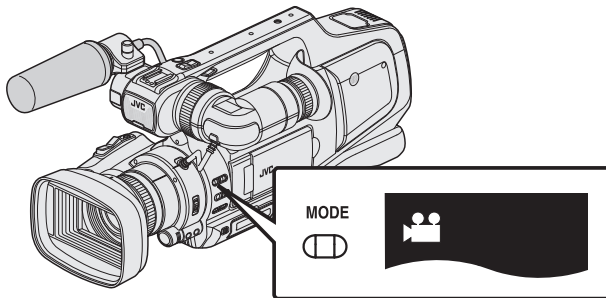

- Check if video mode (📹) is activated.
  - If still image mode (📷) is activated, switch to video mode (📹).
- "Selecting Video/Still Image Recording Mode" (☞ p. 19)

4 Check if the recording mode is **i.A.** Intelligent Auto.

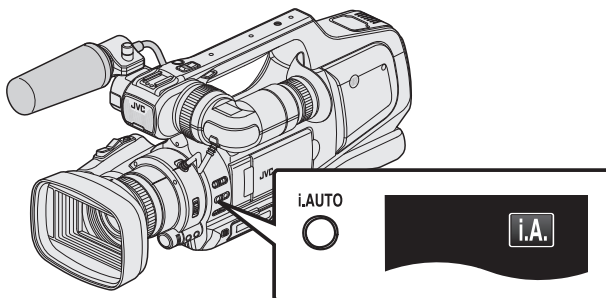

- If Manual (M) is activated, switch to Intelligent Auto (i.A.).
- "Selecting Intelligent Auto/Manual Recording Mode" (☞ p. 18)

5 Start recording.

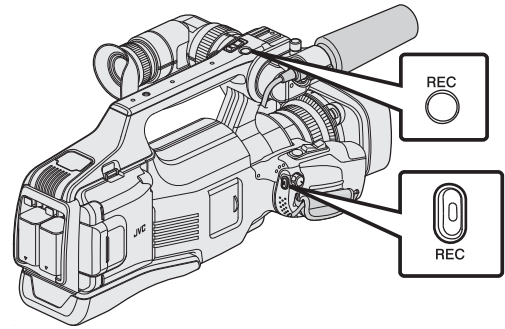



- Press again to stop.
- Some displays disappear after approximately 3 seconds. Use the **D** button to change the displays.
- To use the viewfinder during recording, close the LCD monitor. "Viewing the Viewfinder/LCD Monitor" (☞ p. 14)
- After recording, close the lens cover.

### Memo :

- Depending on the subject and shooting conditions, recording may not be performed properly even in the Intelligent Auto mode.

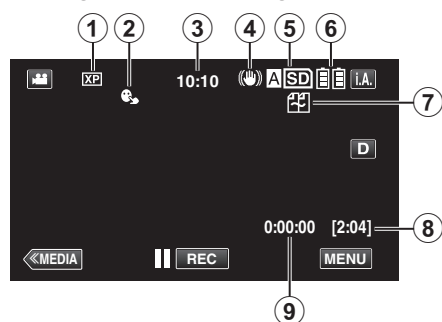

## Indications During Video Recording

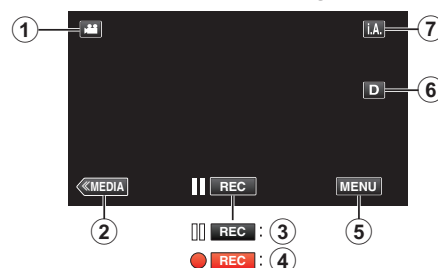

	Display Icon	Description
①	VIDEO QUALITY	Displays the icon of the "VIDEO QUALITY" setting selected in the recording menu. "VIDEO QUALITY" (☞ p. 97)
②	TOUCH PRIORITY AE/AF	Displays the setting of "TOUCH PRIORITY AE/AF". By default, it is set to "OFF". "Capturing Subjects Clearly (TOUCH PRIORITY AE/AF)" (☞ p. 34)
③	Time	Displays the current time. "Clock Setting" (☞ p. 12)
④	IS	Displays the image stabilizer setting. "Reducing Camera Shake" (☞ p. 37)
⑤	Recording Media	Displays the icon of the media where videos are recorded to. The recording media can be changed. "REC VIDEO TO SLOTS" (☞ p. 109)
⑥	Battery Indicator	Displays the approximate remaining battery power during use. "Checking the Remaining Recording Time" (☞ p. 43)
⑦	SEAMLESS RECORDING/Auto Recovery Recording	Displays the seamless recording/auto recovery recording icon when it is set. When only one SD card is being inserted, seamless recording and auto recovery recording cannot be performed.  will appear. <ul style="list-style-type: none"> <li>The icon does not appear when "SEAMLESS RECORDING" is set to "OFF".</li> </ul> "SEAMLESS RECORDING (Seamless recording/Auto recovery recording)" (☞ p. 98)
⑧	Remaining Recording Time	Displays the remaining time for video recording. "Checking the Remaining Recording Time" (☞ p. 43)
⑨	Scene Counter (Recorded Time)	Displays the elapsed time of the video that is currently being recorded.

## Operation Buttons for Video Recording



	Operation Buttons	Description
①	Video/Still Image Mode	Switches between video (50i/50p) and still image modes.
②	Media Mode	Switches to the media (playback) mode.
③ / ④	Recording Start  REC Record-Standby  REC	Functions as the REC button.
⑤	MENU	Displays the various menus of video recording. "Operating the Menu" (☞ p. 95)
⑥	Display Button <b>D</b>	Switches the display between full ( <b>D?</b> ) and simple ( <b>D</b> ) with every tap of the button. <ul style="list-style-type: none"> <li>Simple display: Some displays disappear after approximately 3 seconds.</li> <li>Full display: Displays everything. The display button changes from <b>D</b> to <b>D?</b>.</li> <li>When the power is turned off, simple display (<b>D</b>) will be set.</li> </ul>
⑦	Recording Mode <b>i.A.M</b>	Switches the recording mode.

## Using the Silent Mode

When the Silent mode is used, the LCD monitor darkens and operation sounds will not be output. Use this mode to record quietly in dark places such as during a performance.

-  appears when "SILENT MODE" is set to "ON".

### ■ Operating procedure

1 Tap "MENU".

- The top menu appears.

2 Tap "SILENT".

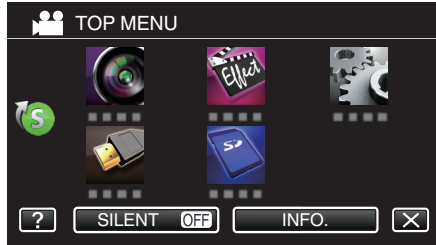

3 Tap "ON".

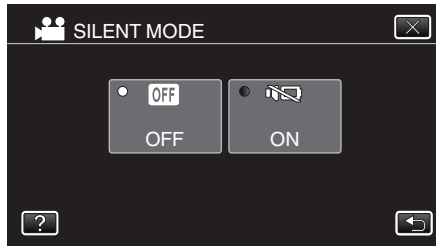

## Useful Settings for Recording

- When "AUTO POWER OFF" is set to "ON", this unit turns itself off automatically to conserve power when it is not operated for 5 minutes. (only when using the battery pack)

"AUTO POWER OFF" (☞ p. 107)

- When "TOUCH PRIORITY AE/AF" is set to "FACE TRACKING", this unit detects faces and automatically adjusts its brightness and focus to record the faces more clearly.

"Capturing Subjects Clearly (TOUCH PRIORITY AE/AF)" (☞ p. 34)

- When "SEAMLESS RECORDING" is set to "ON" with two SD cards inserted, recordings can be made to the other media without stopping when the remaining recording time on current recording media runs out or when error occurs on the current recording media.

"SEAMLESS RECORDING (Seamless recording/Auto recovery recording)" (☞ p. 98)

- When progressive (50p) recording is set, high quality images with a smooth depth of field can be recorded. In addition, fast-moving subjects can also be captured sharply without flickering.

"System Select" (☞ p. 96)

## Caution :

- Do not expose the lens to direct sunlight.
- Do not use this unit in the rain, snow, or places with high humidity like the bathroom.
- Do not use this unit in places subject to excessive humidity or dust, as well as places exposed to steam or smoke directly.
- The power may turn off to protect the circuit if the temperature of this unit rises too much.
- When recording is performed with one battery pack attached, you can attach the other battery pack without stopping the recording.
- If two battery packs are attached, detaching one battery pack does not turn off the power when one or both battery packs contain sufficient battery charge.
- Do not remove the AC adapter or SD card when the access lamp is lighted. The recorded data may become unreadable.
- Do not turn off the camera when the access lamp is lighted. The recorded data may become unreadable.
- This unit is a microcomputer-controlled device. Electrostatic discharge, external noise and interference (from a TV, a radio, etc.) might prevent it from functioning properly. In such a case, turn off the power, then remove the AC adapter and battery pack. This unit will be reset.
- Videos that are recorded in the 50p mode (when "SYSTEM SELECT" is set to "50p") are playable only on AVCHD Progressive compatible devices.

"System Select" (☞ p. 96)

### • Disclaimer

- We shall not be held responsible for loss of recorded contents when recording videos/audio or playback cannot be operated due to malfunctions in this unit, provided parts, or SD card.
- Once deleted, recorded contents (data), including data loss due to malfunctions in this unit, cannot be restored. Please be forewarned.
- JVC will not be responsible for any lost data. Please be forewarned.
- In order for quality improvement, defective recording medium is subject to be analyzed. Therefore, it may not be returned.

## Memo :

- Check the remaining recording time in the media before you start shooting. If there is not enough space, move (copy) the data to a computer or disc.
- When there are many files in the media, it may take time for them to be displayed on the playback screen. Wait for a while as the access lamp appears blinking, which indicates normal operation.
- Do not forget to make copies after recording!
- Recording stops automatically as it cannot be performed for 12 or more consecutive hours according to specifications. (It may take some time to resume recording.)
- For long recordings, the file is split into two or more files if the size exceeds 4 GB.
- 1000 videos (\*\*000.mts to \*\*999.mts) can be recorded.
- You can connect this unit to the AC adapter to record for long hours indoors.
- Depending on the shooting conditions, the four corners of the screen may appear dark, but this is not a malfunction. In this case, change the shooting conditions by moving the zoom lever, etc.

---

### Capturing Still Images During Video Recording

Still images can be captured by pressing the SNAPSHOT button while in the video mode (standby or recording).

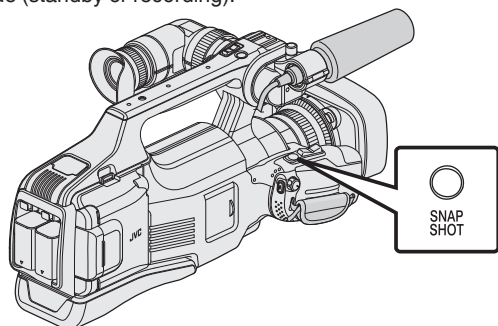

- "PHOTO" lights up on the screen when a still image is being captured.

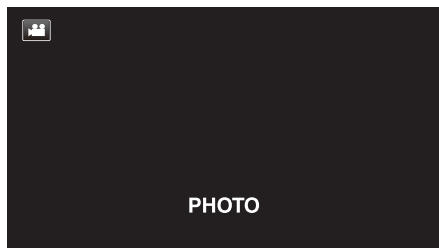

- The still images captured during video recording are saved to the destination set in "REC STILLS TO SLOTS".

---

#### Memo :

- The size of the still image that is captured in the video mode is 1920 x 1080.
  - Operation is invalid under the following conditions:
    - when menu is being displayed
    - when remaining recording time or battery power is being displayed
    - when any functions in "SPECIAL RECORDING" is set
  - When "VIDEO QUALITY" is set to "SSW" or "SEW", it is not possible to capture still image during video recording.
-

## Taking Still Images in Auto Mode

You can record without worrying about the setting details by using the Intelligent Auto mode.

- 1 Open the lens cover.

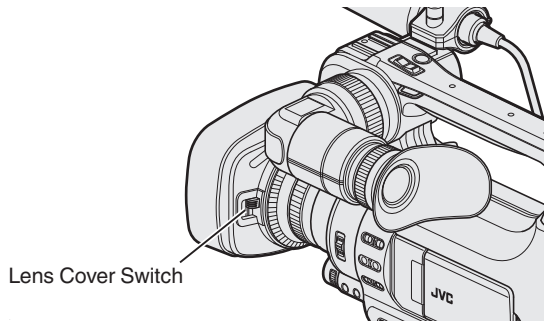

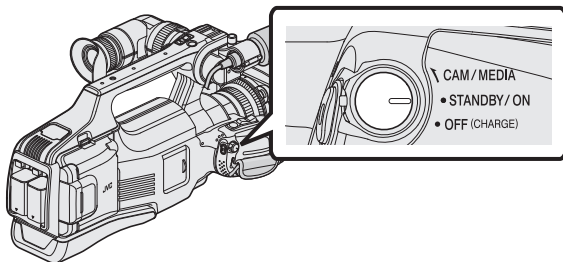

- 2 Set the "STANDBY/ON OFF" switch to "ON".

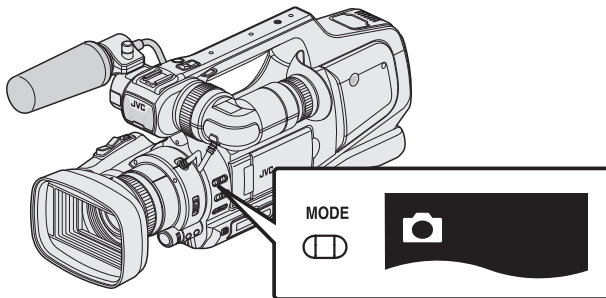

- 3 Check that the unit is in the still image mode.



- Check if still image mode  is activated.
  - If video mode  is activated, switch to still image mode ().
- "Selecting Video/Still Image Recording Mode" (p. 19)

- 4 Check if the recording mode is **i.A.** Intelligent Auto.

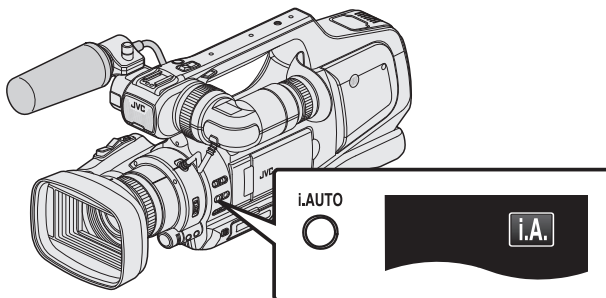

- If Manual (**M**) is activated, switch to Intelligent Auto (**i.A.**).
- "Selecting Intelligent Auto/Manual Recording Mode" (p. 18)

- 5 Set the focus on the subject.

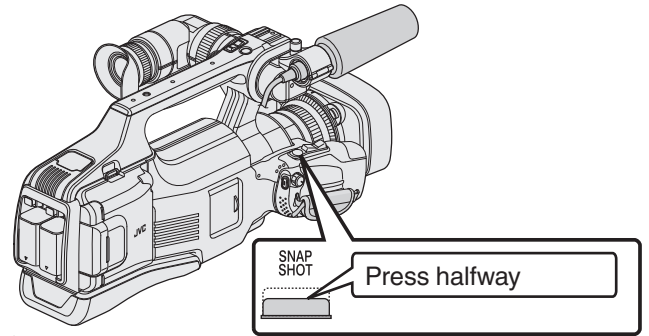

- When focused, the focus icon lights up in green.

- 6 Take a still image.

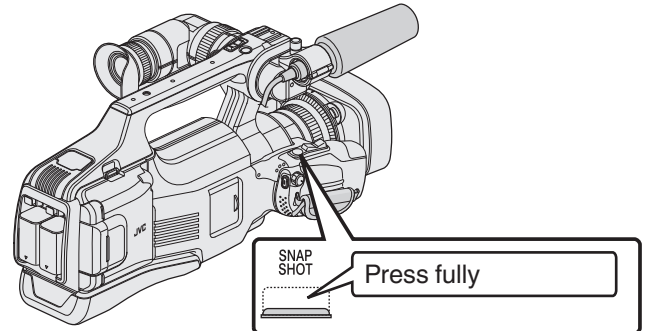

- PHOTO lights up when a still image is being captured.
- Some displays disappear after approximately 3 seconds. Use the **D** button to change the displays.
- To use the viewfinder during recording, close the LCD monitor. "Viewing the Viewfinder/LCD Monitor" (p. 14)
- After recording, close the lens cover.

**Memo :**

- Depending on the subject and shooting conditions, recording may not be performed properly even in the Intelligent Auto mode.



## Indications During Still Image Recording

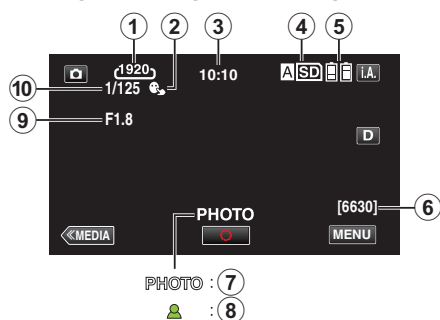

	Display Icon	Description
①	IMAGE SIZE	Displays the icon of the image size. • The size of still images can be changed. “IMAGE SIZE” (☞ p. 103)
②	TOUCH PRIORITY AE/AF	Displays the setting of “TOUCH PRIORITY AE/AF”. By default, it is set to “OFF”. “Capturing Subjects Clearly (TOUCH PRIORITY AE/AF)” (☞ p. 34)
③	Time	Displays the current time. “Clock Setting” (☞ p. 12)
④	Recording Media	Displays the icon of the media where still images are recorded to. The recording media can be changed. “REC STILLS TO SLOTS” (☞ p. 109)
⑤	Battery Indicator	Displays the approximate remaining battery power during use. “Checking the Remaining Recording Time” (☞ p. 43)
⑥	Remaining Number of Shots	Displays the remaining number of shots for still image recording. “Approximate Number of Still Images (Unit: Number of Shots)” (☞ p. 44)
⑦	Recording in Progress	“PHOTO” appears when a still image is being captured.
⑧	Focus	Lights up in green when focused.
⑨	Aperture Value	Displays the aperture value.
⑩	SHUTTER SPEED	Displays the shutter speed.

## Operation Buttons for Still Image Recording



	Operation Buttons	Description
①	Video/Still Image Mode	Switches between video (50i/50p) and still image modes.
②	Media Mode	Switches to the media (playback) mode.
③	Snapshot	Functions as the SNAPSHOT button. However, focus cannot be set by pressing halfway.
④	MENU	Displays the various menus of still image recording. “Operating the Menu” (☞ p. 95)
⑤	Display Button <b>D</b>	Switches the display between full ( <b>D?</b> ) and simple ( <b>D</b> ) with every tap of the button. • Simple display: Some displays disappear after approximately 3 seconds. • Full display: Displays everything. The display button changes from <b>D</b> to <b>D?</b> . • When the power is turned off, simple display ( <b>D</b> ) will be set.
⑥	Recording Mode <b>i.A.M</b>	Switches the recording mode.

## Recording

### Using the Silent Mode

When the Silent mode is used, the LCD monitor darkens and operation sounds will not be output. Use this mode to record quietly in dark places such as during a performance.

-  appears when "SILENT MODE" is set to "ON".

#### ■ Operating procedure

- 1 Tap "MENU".
- The top menu appears.
- 2 Tap "SILENT".



- 3 Tap "ON".

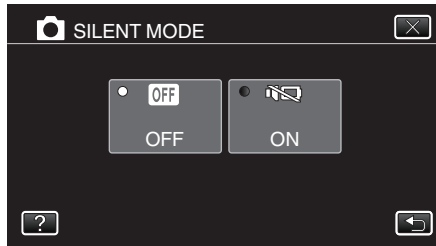

### Useful Settings for Recording

- When "AUTO POWER OFF" is set to "ON", this unit turns itself off automatically to conserve power when it is not operated for 5 minutes. (only when using the battery pack)

"AUTO POWER OFF" (☞ p. 107)

- When "TOUCH PRIORITY AE/AF" is set to "FACE TRACKING", this unit detects faces and automatically adjusts its brightness and focus to record the faces more clearly.

"Capturing Subjects Clearly (TOUCH PRIORITY AE/AF)" (☞ p. 34)

#### Caution :

- Do not expose the lens to direct sunlight.
- Do not use this unit in the rain, snow, or places with high humidity like the bathroom.
- Do not use this unit in places subject to excessive humidity or dust, as well as places exposed to steam or smoke directly.
- The power may turn off to protect the circuit if the temperature of this unit rises too much.
- Do not remove the battery pack, AC adapter, or SD card when the access lamp is lighted. The recorded data may become unreadable.
- Do not turn off the camera when the access lamp is lighted. The recorded data may become unreadable.
- This unit is a microcomputer-controlled device. Electrostatic discharge, external noise and interference (from a TV, a radio, etc.) might prevent it from functioning properly. In such a case, turn off the power, then remove the AC adapter and battery pack. This unit will be reset.

#### Memo :

- Before recording an important scene, it is recommended to conduct a trial recording.
- Depending on the shooting conditions, the four corners of the screen may appear dark, but this is not a malfunction. In this case, change the shooting conditions by moving the zoom lever, etc.

## Zooming

The angle of view can be adjusted using zoom.

- Use the W end (wide angle end) to shoot a wider field of view.
- Use the T end (telephoto end) to magnify the subject for shooting.

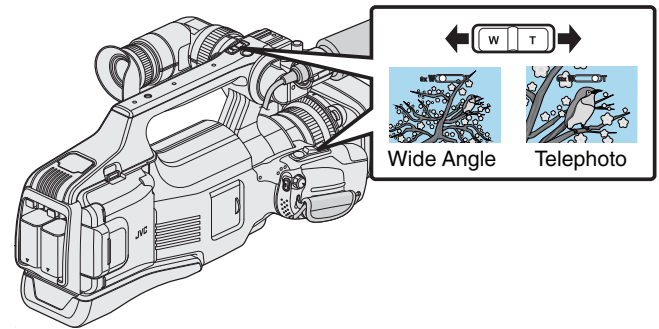

#### Memo :

- When digital zoom is used, the image becomes grainy as it is digitally enlarged.
- The zoom ratio range can be changed.

"ZOOM" (☞ p. 99)

## Adjusting Focus Manually

Turn the focus ring to adjust the focus manually.

- 1 Set the focus switch to "MF".

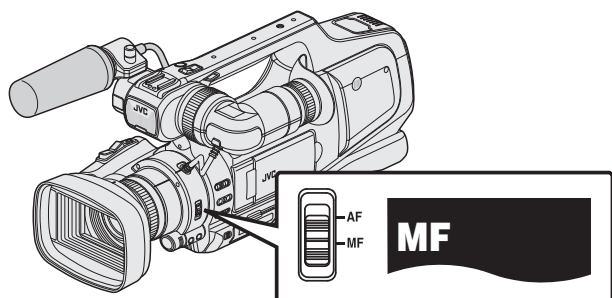

- The manual focus icon "MF" appears.
- 2 Turn the focus ring to adjust the focus.
    - Using the Focus Assist function helps to enable easy focusing.

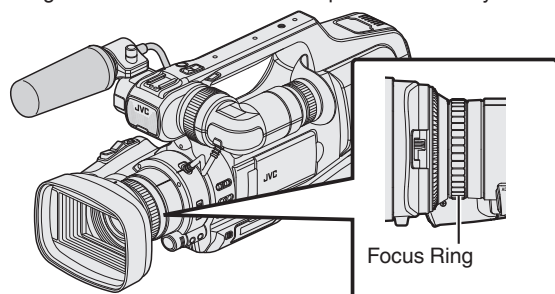

## Adjusting Focus by Using Focus Assist

Focused subject is outlined in color for more precise focus.

- 1 Tap "MENU".

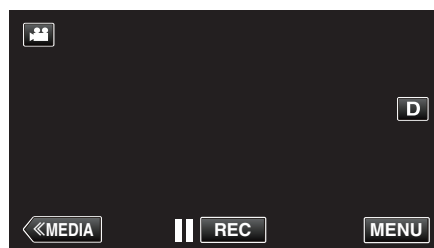

- The top menu appears.

- 2 Tap "RECORD SETTING".



- 3 Tap "FOCUS ASSIST".

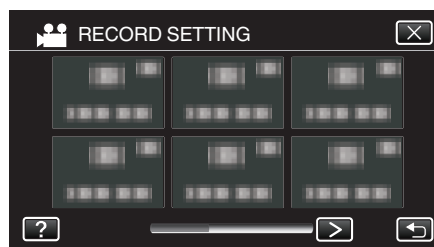

- Tap < or > to move to the previous/next menu.
- Tap X to exit the menu.
- Tap ↶ to return to the previous screen.

- 4 Tap "ON".

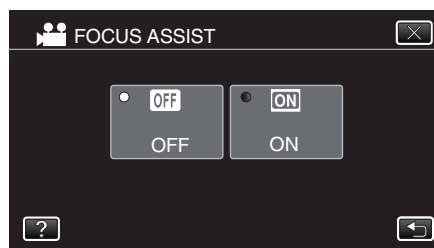

- The screen is displayed in black and white, and contour of focused parts are highlighted in color.

### Memo :

- When setting the Focus Assist function, screen is displayed in black and white, and contour of focused parts are highlighted in pre-set color. Change the color if the contour line is difficult to see.

"RECORD SETTING Menu (video)" (p. 96)

## Displaying Zebra Pattern

During video recording, diagonal lines (zebra pattern) are displayed only at areas with the specified luminance levels.

Zebra Pattern



1 Tap "MENU".

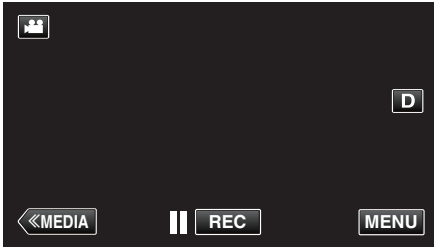

- The top menu appears.

2 Tap "RECORD SETTING".

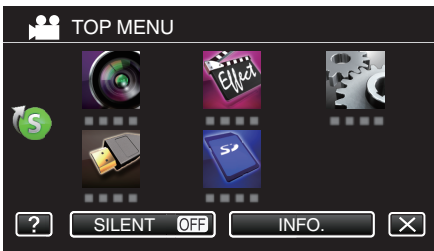

3 Tap "ZEBRA".

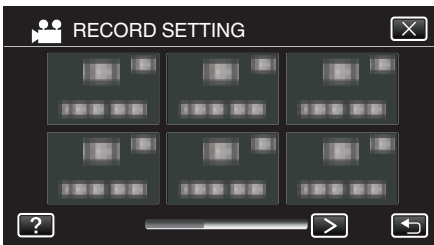

- Tap < or > to move to the previous/next menu.
- Tap X to exit the menu.
- Tap ↶ to return to the previous screen.

4 Tap "70-80%" or "OVER100%".

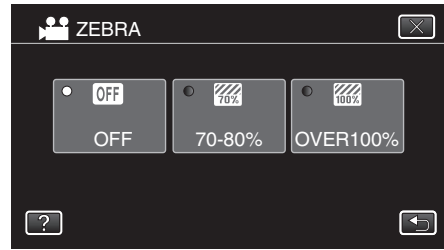

Display	Setting
OFF	Deactivates the function.
70-80%	Sections that are close to be over-exposed are displayed in striped pattern.
OVER100%	Sections that are over-exposed are displayed in striped pattern.

## Adjusting Brightness Manually

Generally, the brightness of the subject that is being shot is automatically adjusted according to the reference values of the camera. However, the brighter or darker areas of an image may appear unclear depending on the shooting conditions. To prevent this from occurring, you can correct the exposure manually.

- 1 Press the "AE ±" button.
  - The AE value appears on the screen, and the adjustment mode is enabled.

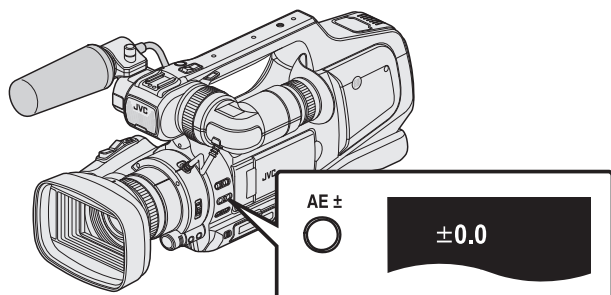

- 2 Turn the "ADJ." dial.

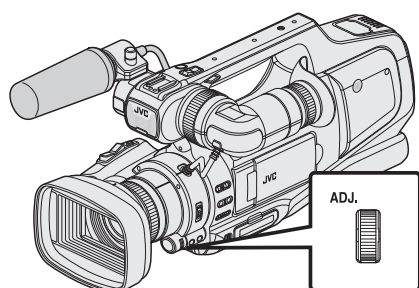

- Turn upward to increase the value and make the image brighter.
- Turn downward to decrease the value and make the image darker.

- 3 Press the "SET" button.

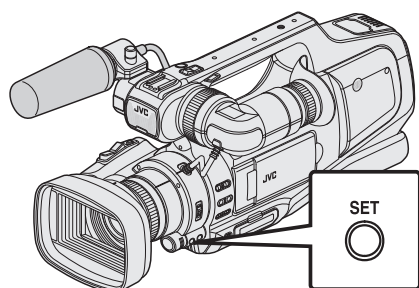

- The manual setting value is set.  
(The setting value (-2.0 to +2.0) is displayed on the screen.)

### Memo :

- Settings can be adjusted separately for videos and still images.
- Brightness, shutter speed and aperture cannot be manually set at the same time.

## Setting exposure compensation to Auto

- 1 Press the "AE ±" button several times until the AE value display disappears.

## Setting Backlight Compensation

You can correct the image when the subject appears too dark due to backlight.

- 1 Tap "MENU".

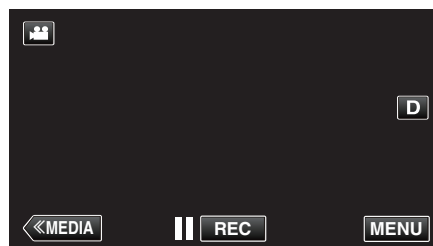

- The top menu appears.

- 2 Tap "RECORD SETTING". (Go to step 4.)  
Alternatively, tap "BACKLIGHT COMP." in the shortcut menu. (Go to step 5.)

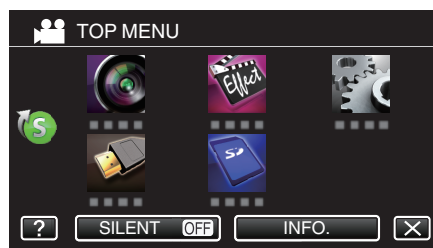

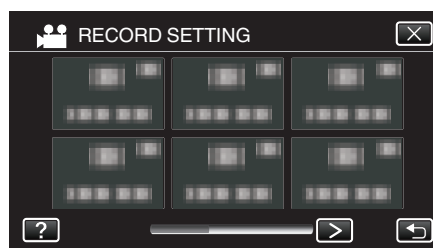

- 3 Tap "BACKLIGHT COMP.".

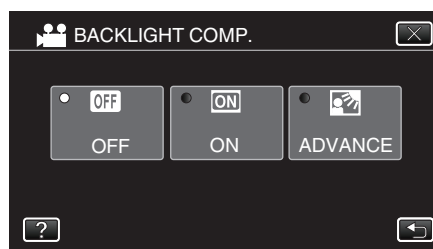

- Tap < or > to move to the previous/next menu.
- Tap X to exit the menu.
- Tap ↶ to return to the previous screen.

- 4 Tap "ON" or "ADVANCE".



- "ADVANCE" is designed to perform more effective backlight compensation. Choose this when the backlight compensation is not adjusted appropriately by "ON".
- After setting, the tele macro icon  appears.

Setting	Details
OFF	Backlight compensation is disabled.
ON	Backlight compensation is enabled.
ADVANCE	Should be selected for a better backlight compensation effect.

### Memo :

- If the exposure compensation has been set manually, backlight compensation cannot be used.

## Adjusting Shutter Speed

The shutter speed can be set to a value according to the user's preference. When this is set to Auto, the shutter speed is automatically controlled.

- 1 Select the Manual recording mode.

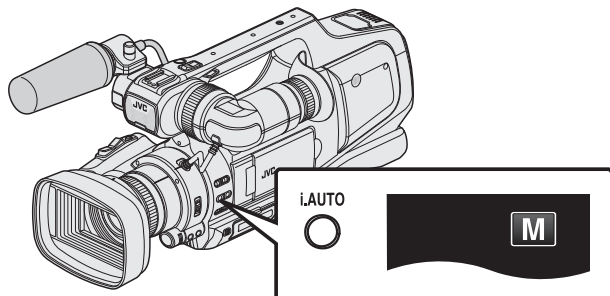

- If Intelligent Auto (**i.A.**) is activated, switch to Manual (**M**).  
“Selecting Intelligent Auto/Manual Recording Mode” (☞ p. 18)

- 2 Press the “SHUTTER” button.

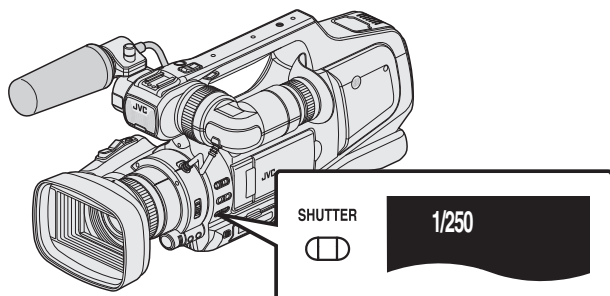

- The current value is displayed.

- 3 Turn the “ADJ.” dial.

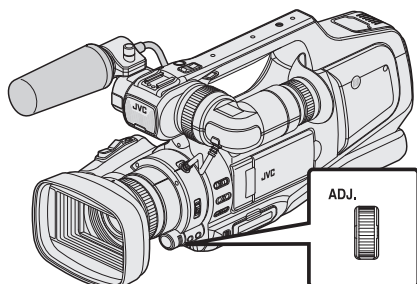

- Turning upwards increases the value.
- Turning downwards decreases the value.

- 4 Press the “SET” button.

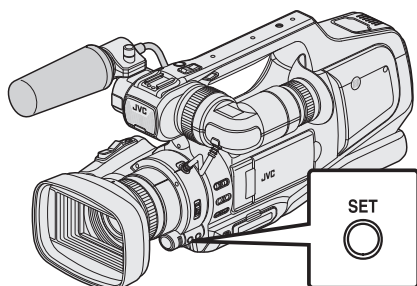

- Confirm the setting and exit the adjustment mode.

### Memo :

- Settings can be adjusted separately for videos and still images.
- Brightness, shutter speed and aperture cannot be manually set at the same time.

### ■ Setting shutter speed to Auto

- 1 Press the “SHUTTER” button several times until the shutter speed value display disappears.

## Adjusting Aperture

The aperture value (F-number) of the lens can be set as follows.

F-number	Details
Decrease	The subject appears brighter. The focused range becomes sharper, while the background is blurred to produce a soft image.
Increase	The subject appears darker. Background of image becomes focused as well.

- 1 Select the Manual recording mode.

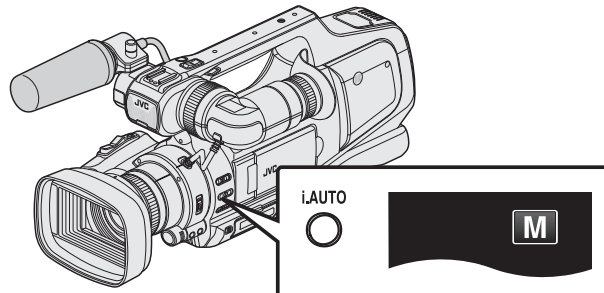

- If Intelligent Auto (**i.A.**) is activated, switch to Manual (**M**).  
“Selecting Intelligent Auto/Manual Recording Mode” (☞ p. 18)

- 2 Press the “IRIS” button.

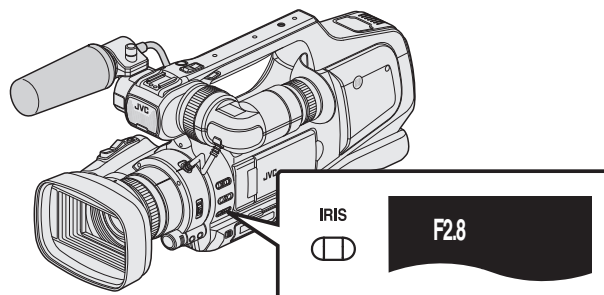

- The current F-number is displayed.

- 3 Turn the “ADJ.” dial.

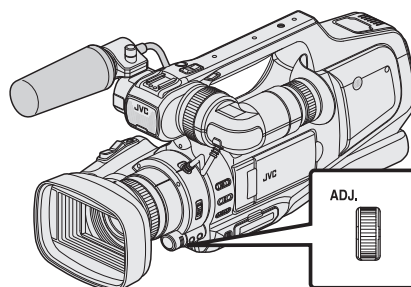

- Turning upwards increases the value.
- Turning downwards decreases the value.

- 4 Press the “SET” button.

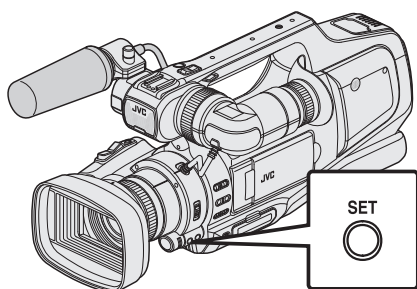

- Confirm the setting and exit the adjustment mode.

**Memo :**

- When zooming to the Tele end, the aperture value is set according to the zoom and indicated in yellow. Set the zoom to the wide angle end to enable the smallest F-number to be set.
- Settings can be adjusted separately for videos and still images.
- Brightness, shutter speed and aperture cannot be manually set at the same time.

**■ Setting aperture to Auto**

- 1 Press the “IRIS” button several times until the F-number display disappears.

## Setting White Balance

You can set the color tone to suit the light source.

- 1 Select the Manual recording mode.

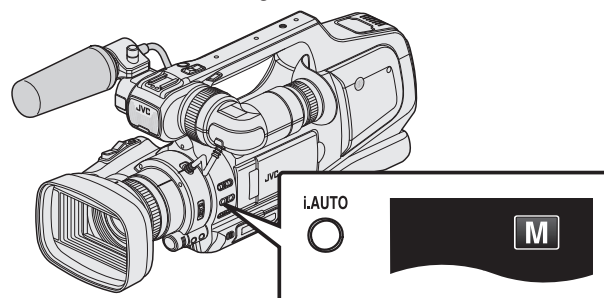

- If Intelligent Auto (**i.A.**) is activated, switch to Manual (**M**). “Selecting Intelligent Auto/Manual Recording Mode” (p. 18)

- 2 Press the “WHT BAL” button.

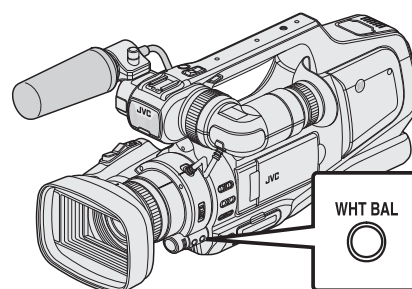

- 3 Tap the appropriate shooting environment.

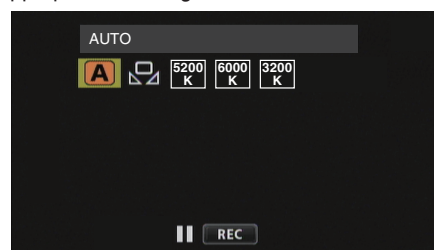

- Turn the “ADJ.” dial to select an item, and press the “SET” button. (Tap the icon directly to select.)
- The White Balance icon appears on the screen upon completing the setting.

Setting	Details
<b>A</b> AUTO	Adjusts automatically to the natural colors.
MWB	Use this when the problem of unnatural colors is not resolved.
5200K	Set this when shooting outdoors on a sunny day.
6000K	Set this when shooting on a cloudy day or inside a shade.
3200K	Set this when shooting under illumination such as a video light.

### Using MWB

- 1 Hold a sheet of plain white paper in front of the lens so that the white paper fills the screen.
- 2 Position the cursor to “MWB”, and press and hold “SET”. Or, press and hold the “MWB” icon.
- The menu disappears and appears.

**Memo :**

- The setting will not change if “MWB” is being tapped too fast (less than 1 second).

## Shooting According to Scene (Subject)

Common scenes that are often encountered can be recorded with the most suitable settings.

1 Select the Manual recording mode.

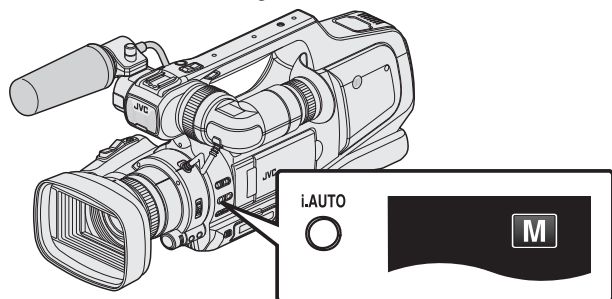

- If Intelligent Auto (i.A.) is activated, switch to Manual (M).  
“Selecting Intelligent Auto/Manual Recording Mode” (p. 18)

2 Tap “MENU”.

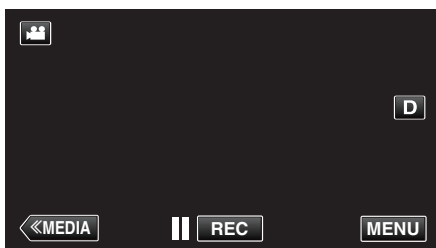

- The top menu appears.

3 Tap “RECORD SETTING”.

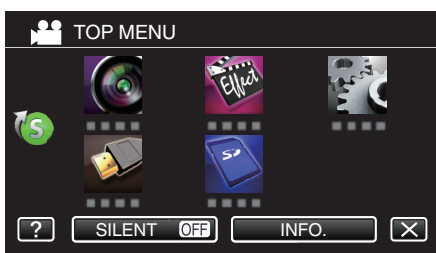

4 Tap “SCENE SELECT”.

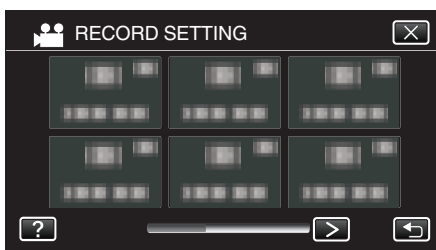

- Tap < or > to move to the previous/next menu.
- Tap X to exit the menu.
- Tap ↶ to return to the previous screen.

5 Tap the appropriate scene.

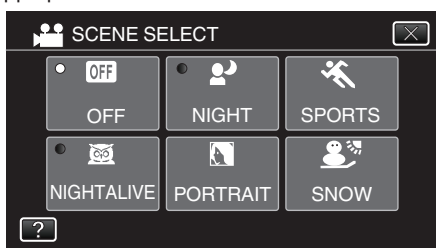

- Tap “OFF” to cancel the selection.
- Tap X to exit the menu.

\*The image is only an impression.

Setting	Effect
NIGHTALIVE	Increases gain and brightens the scene automatically using a slow shutter when the surrounding is dark. To prevent camera shake, use a tripod. <b>OFF</b> <b>ON</b>
NIGHT	Captures night scenes naturally. <b>OFF</b> <b>ON</b> • Capture the image brighter than the actual scene by using a slow shutter in the still image mode.
PORTRAIT	Blurs the background to bring out the people in the picture. <b>OFF</b> <b>ON</b>
SPORTS	Captures fast-moving subjects clearly in every single frame. <b>OFF</b> <b>ON</b>
SNOW	Prevents the subject from appearing too dark when recording snow scenes on a sunny day. <b>OFF</b> <b>ON</b>
SPOTLIGHT	Prevents the human subject from appearing too bright under light. <b>OFF</b> <b>ON</b>

**Memo :**

- All scenes of “SCENE SELECT” cannot be set during “HIGH SPEED RECORDING” or “AUTO REC”.



## Taking Close-up Shots

You can take close-up shots of an object using the tele macro function.



\*The image is only an impression.

1 Select the Manual recording mode.

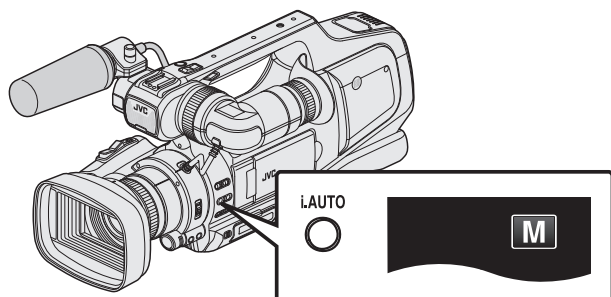

- If Intelligent Auto (**i.A.**) is activated, switch to Manual (**M**).  
“Selecting Intelligent Auto/Manual Recording Mode” (p. 18)

2 Tap “MENU”.

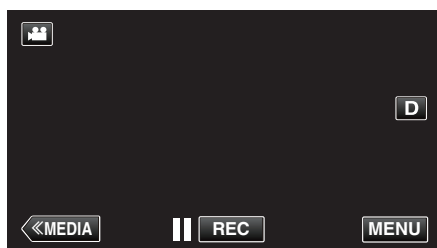

- The top menu appears.

3 Tap “RECORD SETTING”.



4 Tap “TELE MACRO”.

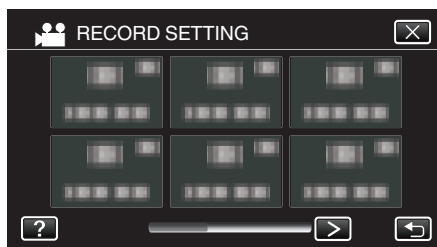

- Tap < or > to move to the previous/next menu.
- Tap X to exit the menu.
- Tap ↶ to return to the previous screen.

5 Tap “ON”.

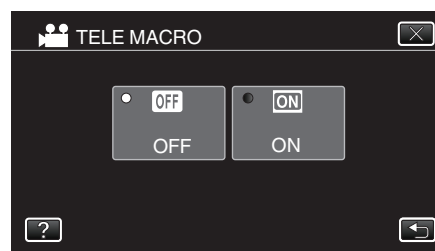

- After setting, the tele macro icon appears.

Setting	Details
OFF	Enables close-up shots up to 1 m at the telephoto (T) end. Enables close-up shots up to 5 cm at the wide angle (W) end.
ON	Enables close-up shots up to 60 cm at the telephoto (T) end. Enables close-up shots up to 5 cm at the wide angle (W) end.

### Caution :

- When you are not taking close-up shots, set “TELE MACRO” to “OFF”.  
Otherwise, the image may be blur.

## Capturing Subjects Clearly (TOUCH PRIORITY AE/AF)

“TOUCH PRIORITY AE/AF” is a function that adjusts focus and brightness based on a tapped position.

This function is available for both videos and still images.

- “TOUCH PRIORITY AE/AF” is disabled when the focus switch is set to “MF”.

1 Tap “MENU”.

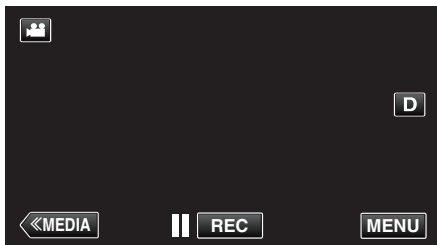

- The top menu appears.

2 Tap “RECORD SETTING”.

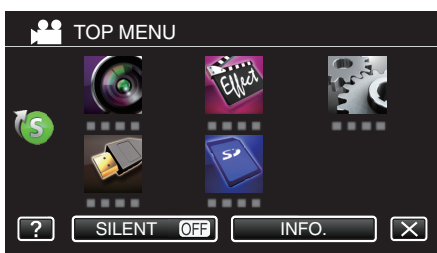

3 Tap “TOUCH PRIORITY AE/AF”.

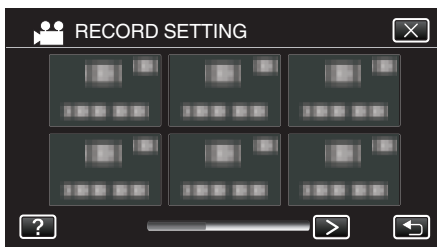

- Tap < or > to move to the previous/next menu.
- Tap X to exit the menu.
- Tap ↶ to return to the previous screen.

4 Tap the desired setting.



FACE TRACKING

COLOR TRACKING

AREA SELECT



- Focus and brightness will be adjusted automatically based on the tapped position (face/color/area). A blue frame appears around the selected subject (face/color), while a white frame appears around the selected area.
- To reset, tap the desired position (face/color/area) again.
- To cancel “FACE TRACKING” or “COLOR TRACKING”, tap the blue frame.
- To cancel “AREA SELECT”, tap the white frame.

Setting	Details
OFF	Deactivates the function.
FACE TRACKING	appears on the screen. Recording is performed while tracking and automatically adjusting the tapped face (subject) with appropriate focus and brightness. In addition, a blue frame appears around the tapped face (subject). (When the face of a person is registered, it becomes the main subject and the blue frame appears even without specific selection.)
COLOR TRACKING	appears on the screen. Recording is performed while tracking and automatically adjusting the tapped color (subject) with appropriate focus and brightness. In addition, a blue frame appears around the tapped color (subject).
AREA SELECT	appears on the screen. Recording is performed while automatically adjusting the tapped area (fixed position) with appropriate focus and brightness. In addition, a white frame appears around the tapped area. AREA SELECT in TOUCH PRIORITY AE/AF is only available within the optical zoom range. (unavailable when digital zoom is being used)

**Memo :**

- Tap the selected position (face/color/area) again to cancel the setting.
- Tap on an unselected position (face/color/area) to reset.
- If the camera loses track of a subject, tap the subject again.
- Settings are canceled when zoom operation is performed. (“AREA SELECT” only)
- When “COLOR TRACKING” is set, the targeted subject (color) may change if similar colors are detected. In this case, tap the subject again. The targeted subject (color) may also be tracked back again if it appears in the center of the screen within a specific time.

**Caution :**

- Subjects near the sides of the LCD monitor may not respond or be recognized when tapped. In this case, move the subject to the center and tap again.
- “FACE TRACKING” may not work properly depending on the shooting conditions (distance, angle, brightness, etc.) and the subject (direction of face, etc.). It is also particularly difficult to detect faces in backlight.
- “COLOR TRACKING” may not function properly in the following cases:
  - when recording subjects with no contrast
  - when recording subjects that are moving at high speed
  - when recording in a dark place
  - when the surrounding brightness changes
- “AREA SELECT” is not available while the digital zoom is in use.
- When “FACE TRACKING” is set, the subject may be lost if the camera is moved vertically or horizontally very fast. For unregistered faces, they cannot be tracked back again. To track back the subject, tap on it again.

## Capturing Smiles Automatically (SMILE SHOT)

“SMILE SHOT” automatically captures a still image upon detection of a smile.

This function is available for both videos and still images.

Set “TOUCH PRIORITY AE/AF” to “FACE TRACKING” before selecting “SMILE SHOT”.

“Capturing Subjects Clearly (TOUCH PRIORITY AE/AF)” (p. 34)

1 Tap “MENU”.

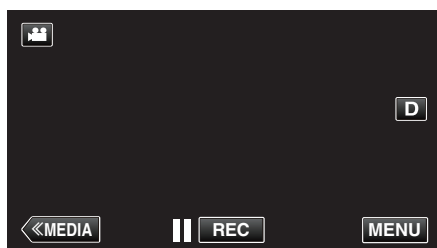

- The top menu appears.

2 Tap “RECORD SETTING”. (Go to step 4.)

Alternatively, tap “SMILE SHOT” in the shortcut menu. (Go to step 5.)

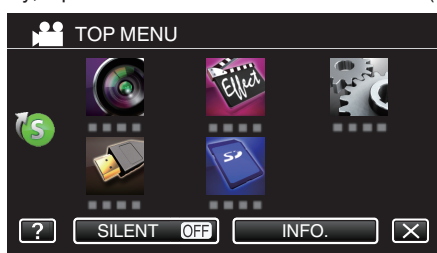

3 Tap “SMILE SHOT”.

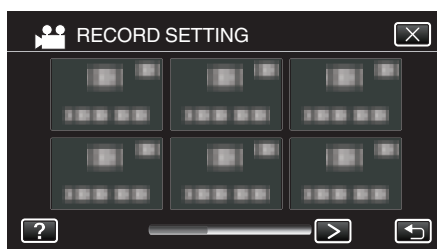

- Tap < or > to move to the previous/next menu.
- Tap X to exit the menu.
- Tap ↶ to return to the previous screen.

4 Tap “ON”.

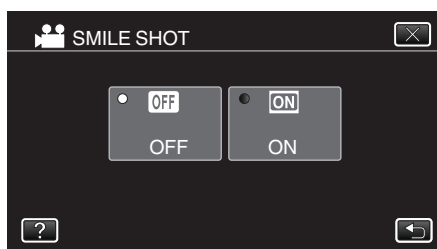

- Tap X to exit the menu as the previous screen appears.

5 Point the camera toward the human subject.

- A still image is automatically captured when smiles are detected.

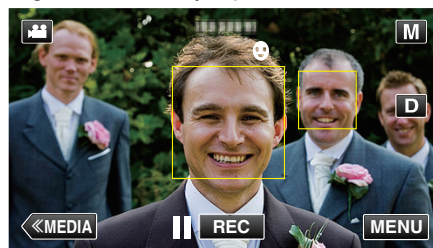

- PHOTO lights up when a still image is being captured.
- You can display the smile level (%) together with the frame by setting “SMILE%” in the menu to “ON” before recording.

“Setting SMILE%” (p. 36)

### Memo :

- The camera is able to detect up to 16 faces. Smile levels will be displayed for up to 3 of the largest faces displayed on the screen.
- This function may not work properly depending on the shooting conditions (distance, angle, brightness, etc.) and the subject (direction of face, smile level, etc.). It is also difficult to detect a smile in backlight.
- After a smile is detected and captured, it takes time before the next recording may be performed.
- “SMILE SHOT” does not work in the following cases:
  - when menu is being displayed
  - when remaining recording time or battery power is being displayed
  - when any functions in “SPECIAL RECORDING” is set

### Caution :

- If “TOUCH PRIORITY AE/AF” is not set to “FACE TRACKING”, “SMILE SHOT” will not work.
- If appropriate results cannot be obtained, record with “SMILE SHOT” set to “OFF”.
- When “VIDEO QUALITY” is set to “SSW” or “SEW”, smile shot does not function.

## Setting SMILE%

“SMILE%” allows you to set the items to display when faces are detected. This item is only displayed when “TOUCH PRIORITY AE/AF” is set to “FACE TRACKING”.

This function is available for both videos and still images.

“Capturing Subjects Clearly (TOUCH PRIORITY AE/AF)” (p. 34)

1 Tap “MENU”.

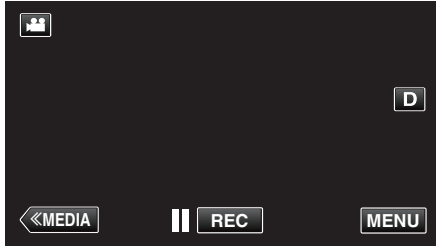

- The top menu appears.

2 Tap “RECORD SETTING”. (Go to step 4.)

Alternatively, tap “SMILE%” in the shortcut menu. (Go to step 5.)

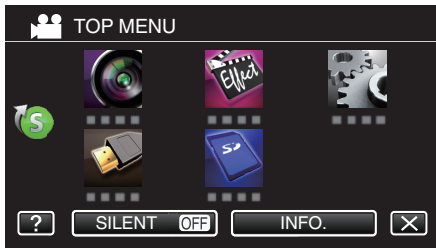

3 Tap “SMILE%”.

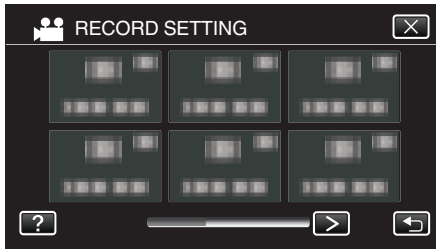

- Tap < or > to move to the previous/next menu.
- Tap X to exit the menu.
- Tap ↶ to return to the previous screen.

4 Tap the desired setting.

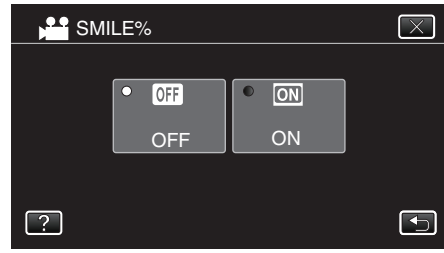

Setting	Details
OFF	Displays only the frames when faces are detected.
ON	Displays the frames and smile levels (%) when faces are detected.

- Frame: Appears around detected faces.  
Smile level: Appears in value (0 % - 100 %) for detected smiles.



### Memo :

- The camera is able to detect up to 16 faces. Smile levels will be displayed for up to 3 of the largest faces displayed on the screen.
- Some faces may not be detected depending on the shooting environment.

## Reducing Camera Shake

When the image stabilizer is set, camera shake during recording can be effectively reduced.

- 1 Tap "MENU".

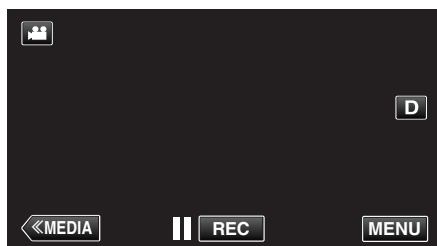

- The top menu appears.

- 2 Tap "RECORD SETTING".

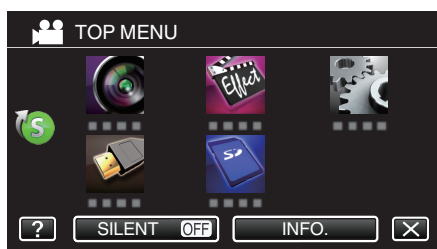



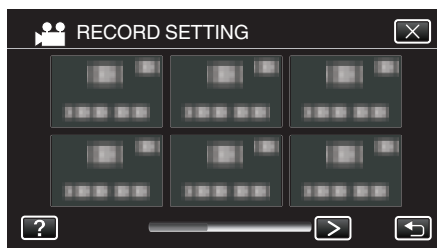



- 3 Tap "IS".



- Tap < or > to move to the previous/next menu.
- Tap X to exit the menu.
- Tap ↶ to return to the previous screen.

- 4 Tap the desired setting.

Setting	Details
 OFF	Deactivates image stabilizer.
 ON	Reduces camera shake under normal shooting conditions.
 ON (AIS)  video mode only	Reduces camera shake more effectively when shooting bright scenes on the wide angle end. Only on the wide angle end (approx. 5x).
 ON (Enhanced AIS)  video mode only	The area of correction in the enhanced AIS mode is greater than that in the AIS mode. Camera shake can be reduced more effectively even when recording is performed by zooming from wide angle to telephoto, or moving together with the subject.

- For still image mode, only "OFF" and "ON" are available.
- When "VIDEO QUALITY" is set to "SSW" or "SEW", Enhanced AIS mode cannot be used.

### Memo :

- It is recommended to set the image stabilizer to "OFF" when shooting a subject of little movement with the unit on a tripod.
- Complete stabilization may not be possible if camera shake is excessive.
- When "ON (AIS)" is set, the angle of view becomes narrower. In the enhanced AIS mode, the angle of view becomes even narrower than "ON (AIS)".
- Image stabilization only starts when the SNAPSHOT button is pressed halfway during still image recording.

## Slow-motion (High-speed) Recording

You can record videos in slow-motion by increasing the recording speed to emphasize the movements, and play back the slow-motion video smoothly. This is a handy function for checking movements, such as golf swings.

<b>Recording Speed</b>	250 fps
<b>Image Size</b>	720x576
<b>Maximum Recording Time</b>	144 m
<b>Maximum Playback Time</b>	12 h
<b>Image Size when Connected to Monitor</b>	1920x1080

- The playback time will be 5 times of the actual recorded time. (Example: If the recorded time is 1 minute, the playback time will be 5 minutes.)

1 Check that the unit is in the video mode.

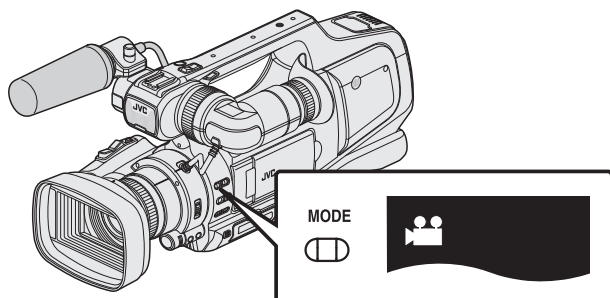

- Check if video mode is activated.
  - If still image mode is activated, switch to video mode .
- “Selecting Video/Still Image Recording Mode” (p. 19)

2 Tap “MENU”.

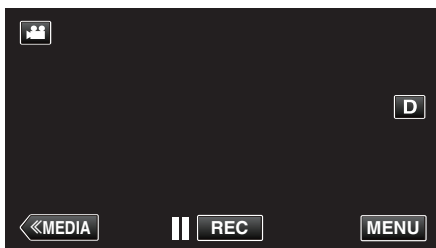

- The top menu appears.

3 Tap “SPECIAL RECORDING”.

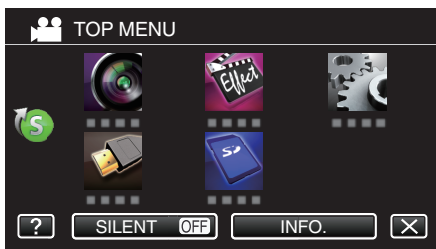

4 Tap “HIGH SPEED RECORDING”.

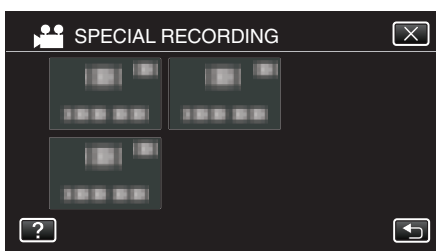

- Tap X to exit the menu.
- Tap to return to the previous screen.

5 Tap “ON”.

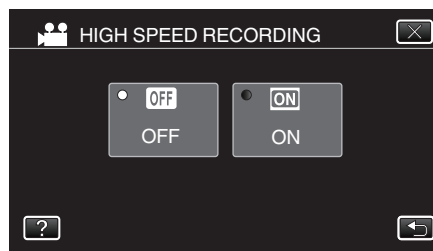

- When “ON” is tapped, 250 frames can be recorded in 1 second.
- To cancel high-speed recording, tap “OFF”.

6 Start recording.

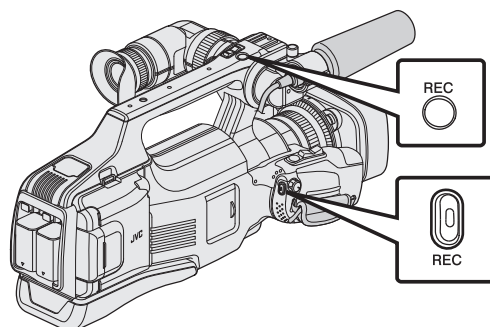

- Press again to stop.
- Settings of high-speed recording are not saved when the power is turned off.

### Memo :

- Images may appear grainier than other videos. The image displayed on the LCD monitor during recording may also appear grainier.
- Audio sound is not recorded together with the video.
- When high-speed recording is enabled, only the optical zoom can be used.
- During high-speed recording, “TOUCH PRIORITY AE/AF” is set to “OFF”. In addition, as image stabilizer is set to “OFF”, it is recommended that a tripod be used, and recording be performed in a bright location with the subject magnified as much as possible.

“Tripod Mounting” (p. 15)

## Recording at Intervals (TIME-LAPSE RECORDING)

Enables the changes of a scene that occur slowly over a long period to be shown within a short time by taking frames of it at a certain interval. This is useful for making observations such as the opening of a flower bud.

- 1 Check that the unit is in the video mode.

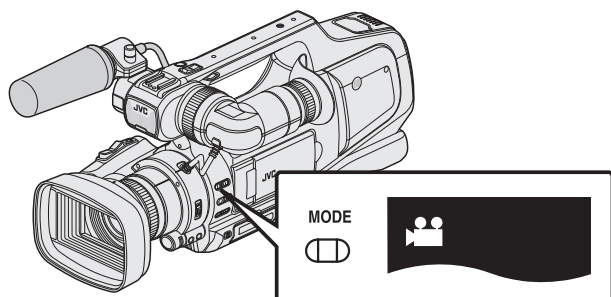

- Check if video mode is activated.
  - If still image mode is activated, switch to video mode ().
- “Selecting Video/Still Image Recording Mode” (p. 19)

- 2 Tap “MENU”.

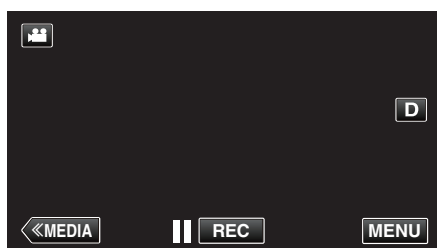

- The top menu appears.

- 3 Tap “SPECIAL RECORDING”.

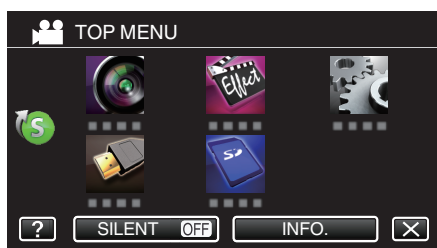

- 4 Tap “TIME-LAPSE RECORDING”.

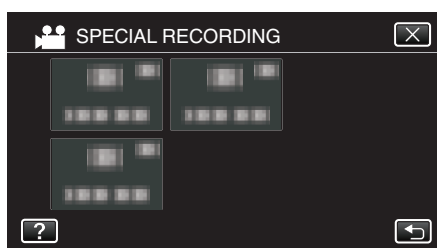

- Tap to exit the menu.
- Tap to return to the previous screen.

- 5 Tap to select a recording interval (1 to 80 seconds).

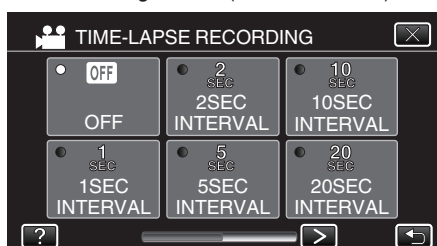

- The greater the number of seconds, the longer the recording interval.
- Tap or to scroll the screen.

- 6 Start recording.

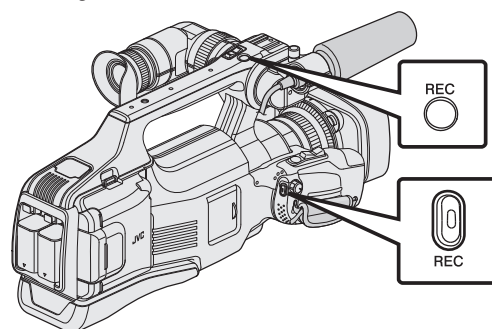

- A frame is taken at intervals of the selected period.
- When the recording interval is set to “20SEC INTERVAL” or higher, this unit switches to the power-saving mode between recordings. At the next point to record, the power-saving mode will be turned off and recording will start automatically.
- Press again to stop.
- Settings of Time-Lapse recording are not saved when the power is turned off.

### Indications During Time-Lapse Recording

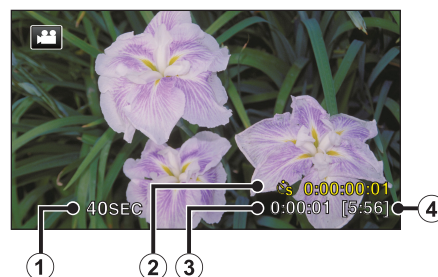

	Display	Description
①	Recording interval	Displays the recording interval that is set.
②	Recorded Time	Displays the actual recorded time of the video. Recorded time increases in units of frames.
③	Actual Elapsed Time	Displays the actual elapsed time after recording starts.
④	Remaining Recording Time	Remaining time left to record with the currently selected video quality.

## Time-Lapse Setting

The greater the number of seconds, the longer the recording interval.

Setting	Details
<b>OFF</b>	Deactivates the function.
<b>1SEC INTERVAL</b>	Takes a frame at 1-second intervals. Recorded videos will be played back at 25 times speed.
<b>2SEC INTERVAL</b>	Takes a frame at 2-second intervals. Recorded videos will be played back at 50 times speed.
<b>5SEC INTERVAL</b>	Takes a frame at 5-second intervals. Recorded videos will be played back at 125 times speed.
<b>10SEC INTERVAL</b>	Takes a frame at 10-second intervals. Recorded videos will be played back at 250 times speed.
<b>20SEC INTERVAL</b>	Takes a frame at 20-second intervals. Recorded videos will be played back at 500 times speed.
<b>40SEC INTERVAL</b>	Takes a frame at 40-second intervals. Recorded videos will be played back at 1000 times speed.
<b>80SEC INTERVAL</b>	Takes a frame at 80-second intervals. Recorded videos will be played back at 2000 times speed.

### Caution :

- Audio cannot be recorded during time-lapse recording.
- Zooming, simultaneous still image recording, and image stabilizer are not available in time-lapse recording.
- When recording is stopped with the recorded time less than "0:00:00:14", the video will not be saved.
- Seamless recording is disabled in time-lapse recording.

### Memo :

- Settings of time-lapse recording are reset when the power is turned off. To start time-lapse recording again, it is necessary to make the selection once more.
- Recording stops automatically 99 hours after it is started.
- Make use of a tripod and AC adapter for time-lapse recordings with long intervals. It is also recommended to fix the focus and white balance manually.

"Tripod Mounting" (p. 15)

"Adjusting Focus Manually" (p. 27)

"Setting White Balance" (p. 31)

- If the video is recorded in progressive format (50p), the playback speed is doubled.  
(Example) A video recorded using "1SEC INTERVAL" is played back at 50 times normal speed.

## Recording Automatically by Sensing Movements (AUTO REC)

This function enables the unit to record automatically by sensing the changes in subject's movement (brightness) within the red frame displayed on the LCD monitor. (AUTO REC)

It can be set for both video and still image modes.

- 1 Compose the picture according to the subject.
  - Adjust the angle of view with the zoom, etc.
- 2 Tap "MENU".

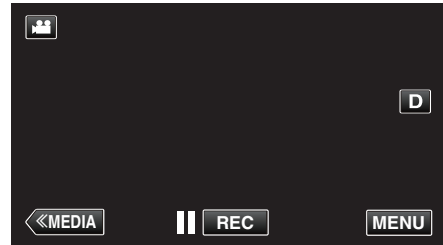

- The top menu appears.

- 3 Tap "SPECIAL RECORDING".

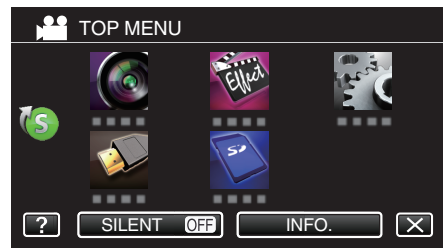

- 4 Tap "AUTO REC".



- Tap X to exit the menu.
- Tap ↶ to return to the previous screen.

- 5 Tap "ON".

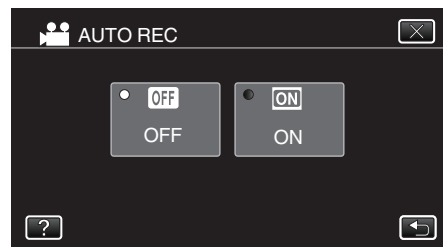



- 6 Recording starts automatically when the subject within the red frame moves.

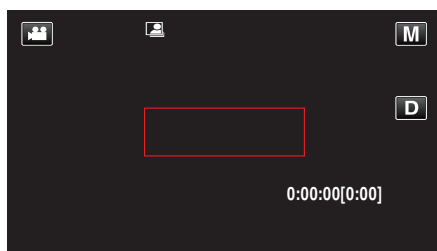

- A red frame appears 2 seconds after the menu display disappears.
- For video recording, recording continues while there are still movements of the subject (changes in brightness) within the red frame. When there are no more movements of the subject (changes in brightness) within the red frame, recording will stop in 5 seconds.
- To stop video recording manually, press the REC button. However, as the "AUTO REC" setting remains at "ON" even after the video recording is stopped, recording starts again when movements of the subject (changes in brightness) are detected within the red frame. To cancel "AUTO REC", set it to "OFF".

**Caution :** \_\_\_\_\_

- Digital zoom, image stabilizer, self-timer, and continuous shooting are not available after "AUTO REC" is set.
- "AUTO REC" cannot be used together with "TIME-LAPSE RECORDING". When both are set, priority is given to "TIME-LAPSE RECORDING".
- "IMAGE SIZE" cannot be changed after "AUTO REC" is selected. Set it before selecting "AUTO REC".
- The auto power off and power-saving modes are not available after "AUTO REC" is set.

**Memo :** \_\_\_\_\_

- Recording stops when there are no changes for 5 seconds during video recording.
- Settings of "AUTO REC" are not saved when the power is turned off.
- Recording may not start when the movements of the subject within the red frame are too fast or the changes in brightness are too small.
- Recording may start due to changes in brightness even if there is no movement within the red frame.
- While zooming, recording cannot be started.

## Taking Group Shots (Self-timer)



The 10-second self-timer and Face Detection self-timer are convenient functions for taking group photos. The 2-second self-timer is useful for preventing camera shake caused by pressing the shutter button.

**Memo :** \_\_\_\_\_  
When shooting a photo using the self-timer function, use of a tripod is recommended.  
"Tripod Mounting" (☞ p. 15)

### Using the 2-/10-second Self-timer

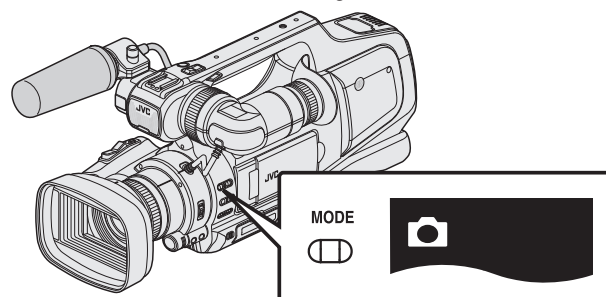
- 1 Check that the unit is in the still image mode.



- Check if still image mode  is activated.
  - If video mode  is activated, switch to still image mode .
- "Selecting Video/Still Image Recording Mode" (☞ p. 19)

- 2 Tap "MENU".

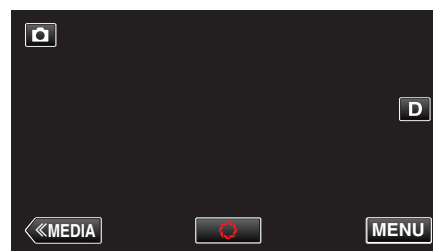

- The top menu appears.

- 3 Tap "RECORD SETTING".



4 Tap "SELF-TIMER".

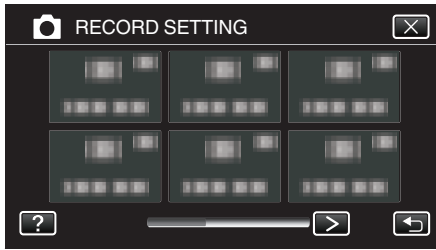

- Tap < or > to move to the previous/next menu.
- Tap X to exit the menu.
- Tap ↶ to return to the previous screen.

5 Tap "2SEC" or "10SEC".

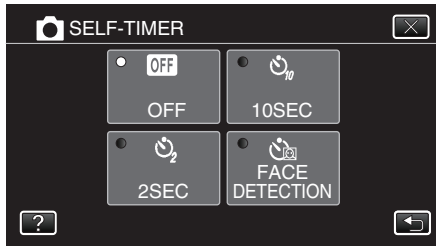

6 Set the focus on the subject.

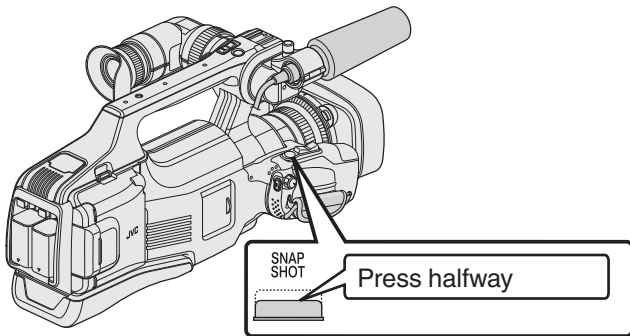

- When focused, the focus icon lights up in green.

7 Take a still image.

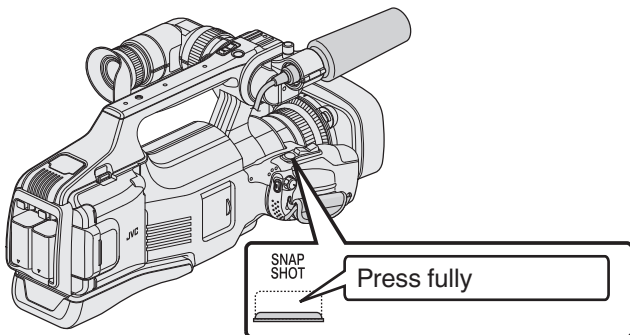

- A timer appears and countdown to shooting starts.
- To stop the self-timer, press the SNAPSHOT button again.

## Using the Face Detection Self-timer

Pressing the SNAPSHOT button starts face detection, and shooting is performed three seconds after another person enters the frame. This function is useful when you want to include the photographer in the group photo.

1 Check that the unit is in the still image mode.

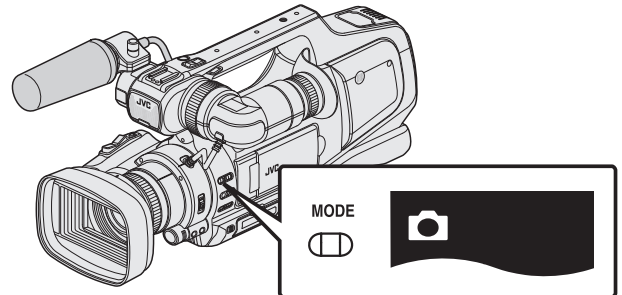

- Check if still image mode is activated.
- If video mode is activated, switch to still image mode . "Selecting Video/Still Image Recording Mode" (p. 19)

2 Tap "MENU".

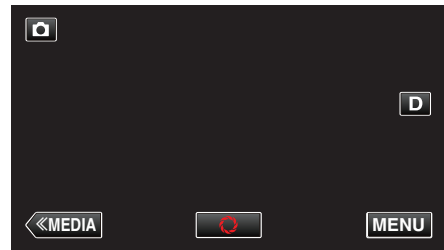

- The top menu appears.

3 Tap "RECORD SETTING".



4 Tap "SELF-TIMER".

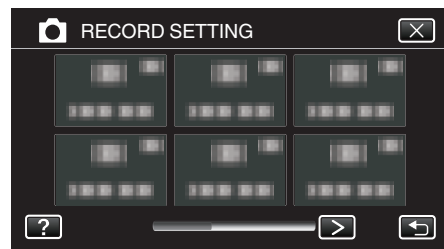

- Tap < or > to move to the previous/next menu.
- Tap X to exit the menu.
- Tap ↶ to return to the previous screen.

5 Tap "FACE DETECTION".

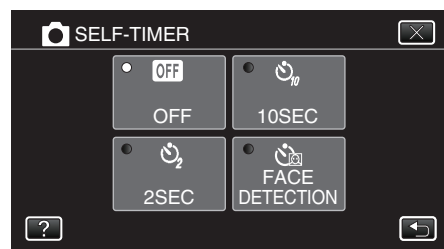

- 6 After making sure that everyone is facing the camera, press the SNAPSHOT button.

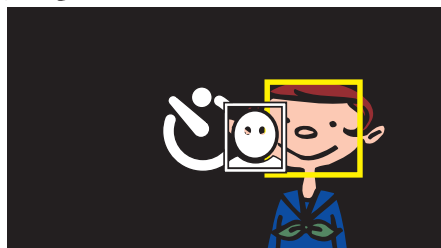
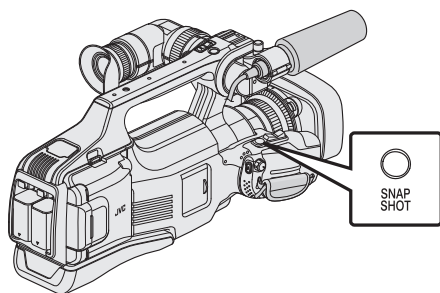

- Frames appear around the faces of the subjects.
- Pressing the SNAPSHOT button again starts the 10-second self-timer.

- 7 The photographer enters the frame.

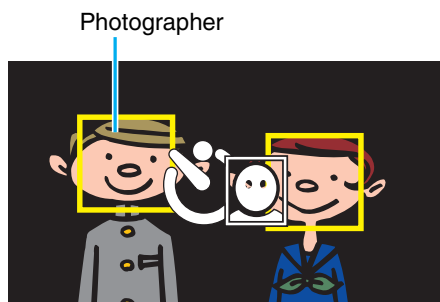

- The shutter is released three seconds after the photographer enters the frame.
- To stop the self-timer, press the SNAPSHOT button again.

**Memo :** \_\_\_\_\_

- The "FACE DETECTION" function may fail to detect faces depending on the shooting environment.

## Checking the Remaining Recording Time

You can check the remaining recording time on the SD card as well as the remaining battery power.

- 1 Tap "MENU".

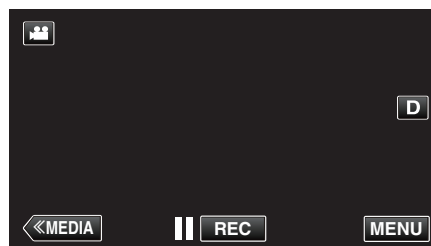

- The top menu appears.

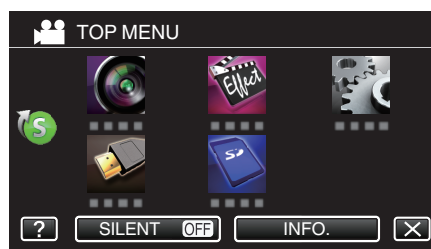

- 2 Tap "INFO.".

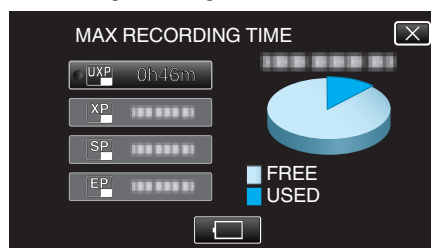

- If in the still image mode, go directly to step 4.

- 3 Display the remaining recording time.



- The remaining recording time is displayed only in the video recording mode.
- To display the remaining battery power, tap .
-  will not be displayed when the AC adapter is connected.
- To exit the display, tap X.

- 4 Display the remaining battery power.

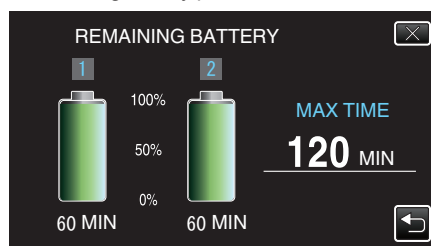

- "MAX TIME" is an approximate value.
- When two battery packs are attached, "MAX TIME" displays the total time of both battery packs.
- For video recording, tap  to return to the remaining recording time display.
- Tap X to exit the display.
- Remaining battery power will not be displayed when the AC adapter is connected.

**Memo :** \_\_\_\_\_

- You can change to the desired video quality by tapping on it from the remaining recording time display.

## Recording

### Approximate Video Recording Time

Quality	SDHC/SDXC card						
	4 GB	8 GB	16 GB	32 GB	48 GB	64 GB	128 GB
50p	15 m	35 m	1 h 10 m	2 h 30 m	3 h 50 m	5 h	10 h 10 m
UXP	20 m	40 m	1 h 20 m	2 h 50 m	4 h 10 m	5 h 40 m	11 h 30 m
XP	30 m	1 h	2 h	4 h	6 h	8 h 10 m	16 h 20 m
SP	40 m	1 h 20 m	2 h 50 m	5 h 50 m	8 h 30 m	11 h 30 m	23 h 10 m
EP	1 h 40 m	3 h 30 m	7 h 10 m	14 h 40 m	21 h 30 m	28 h 50 m	57 h 50 m
SSW	1 h 20 m	2 h 40 m	5 h 30 m	11 h 20 m	16 h 40 m	22 h 20 m	44 h 50 m
SEW	2 h 50 m	5 h 40 m	11 h 30 m	23 h 30 m	34 h 30 m	46 h 10 m	92 h 40 m

- The actual recording time may shorten depending on the shooting environment.

### Approximate Number of Still Images (Unit: Number of Shots)

Image Size	SDHC Card			
	4 GB	8 GB	16 GB	32 GB
4000x3000 (12M) (4:3)	500	1100	2200	4500
2816x2112 (5.9M) (4:3)	1100	2200	4500	9200
2048x1536 (3.1M) (4:3)	2100	4200	8500	9999
1920x1080 (2.1M) (16:9)	3100	6500	9999	9999
640x480 (0.3M) (4:3)	9999	9999	9999	9999

- Still images that are captured during video recording or video playback are saved at a size of 1920 x 1080.

### Approximate Recording Time (Using Battery)

Battery Pack	Actual Recording Time		Continuous Recording Time	
	50i	50p	50i	50p
BN-VF815U	1 h 15 m	1 h 10 m	2 h 25 m	2 h 15 m
BN-VF823U (supplied)	1 h 50 m	1 h 45 m	3 h 30 m	3 h 25 m

- The recording time stated above is when one battery pack is used.
- The above are values when "MONITOR BRIGHTNESS" is set to "3" (standard).
- The actual recording time is an estimate in case that such operations as zooming is used or recording is stopped repeatedly. It may be shorter in the actual usage. (It is recommended to prepare battery packs ready for three times the expected recording time.)
- Recording time may differ depending on the shooting environment and usage.
- When the battery life is reached, the recording time becomes shorter even if the battery pack is fully charged. (Replace the battery pack with a new one.)

## Playing Back Videos

The followings are the types of playback that can be performed by this unit.

Normal Playback	Plays back the recorded videos.
DIGEST PLAYBACK	You can play back a digest of the recorded videos (Digest Playback).
PLAYBACK PLAYLIST	Plays back the playlists that you have created. Start the playback from "PLAYBACK PLAYLIST" in the "PLAYBACK SETTING" menu.

### Switching to the video playback screen

1 Check that the unit is in the video mode.

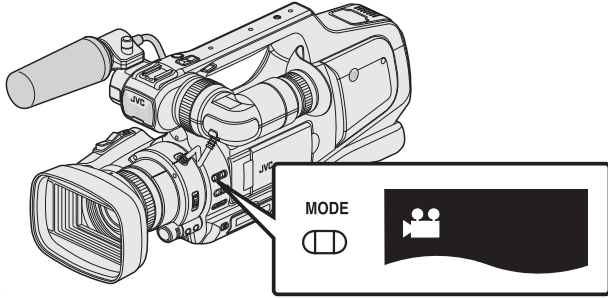

- Check if video mode is activated.
  - If still image mode is activated, switch to video mode .
- "Selecting Video/Still Image Recording Mode" (p. 19)

2 Tap <<MEDIA to select the playback mode.

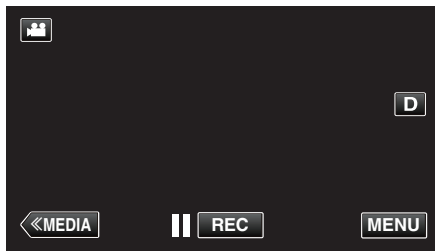

3 The video playback screen is displayed.



## Operation Buttons for Video Playback

### During Index Screen Display

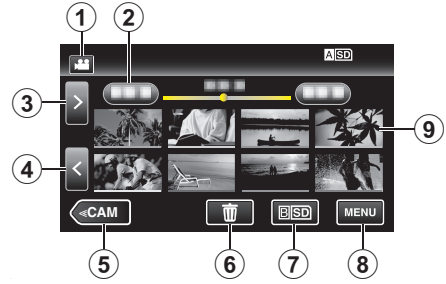

	Display	Description
①	Video/Still Image Mode	Switches between video (50i/50p) and still image modes.
②	Date	Moves to the previous/next date
③	>	Displays the next index screen (thumbnail display) <ul style="list-style-type: none"> <li>• You can perform the same operation with the zoom lever.</li> </ul>
④	<	Displays the previous index screen (thumbnail display) <ul style="list-style-type: none"> <li>• You can perform the same operation with the zoom lever.</li> </ul>
⑤	<<CAM	Switches to the camera (recording) mode.
⑥		Displays the index screen (thumbnail display) to perform deletion
⑦	A/SD/B/SD	Switches between the SD card slots.
⑧	MENU	Displays the menu screen
⑨	Thumbnail (File)	Tap on thumbnail - Starts playback Drag to right - Scrolls to the right to show the previous index screen (thumbnail display) Drag to left - Scrolls to the left to show the next index screen (thumbnail display) Images with the same underlined color indicates the same recording date.

## During Video Playback

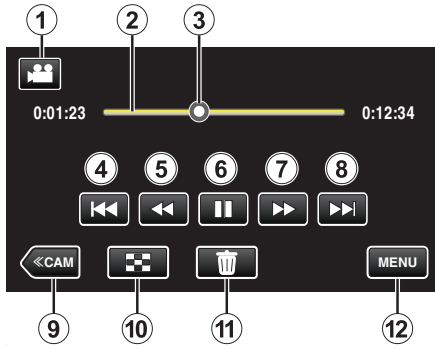

### Memo :

- Tap or drag on the operation area of the touch screen.
  - Operations buttons on the touch screen disappear if the unit is not operated for about 5 seconds. Tap on the screen to display the operation buttons again.
  - You can search for a specific file by the recording date.
- “Searching for a Specific Video/Still Image by Date” (☞ p. 54)
- The recording date and time can be displayed on the screen during playback.
- “DISPLAY DATE/TIME” (☞ p. 104)
- Displays the approximate remaining battery power during use.

	Display	Description
①	Video/Still Image Mode	Switches between video (50i/50p) and still image modes.
②	Timeline Bar	Drag the playback point to the left or right to move the position on a video. Tap on a random position to move to the tapped position.
③	Pointer	Displays the current estimated playback position within the scene
④	⏮	Returns to the beginning of the scene Returns to the previous scene if tapped at the beginning of a scene. • You can perform the same operation with the zoom lever.
⑤	⏪	Reverse search (speed increases with each tap)
⑤	⏩	Reverse slow-motion / Press and hold to start reverse slow playback
⑥	▶ / ⏸	Playback/pause
⑦	⏭	Forward search (speed increases with each tap)
⑦	⏩	Forward slow-motion / Press and hold to start slow playback
⑧	⏮	Advances to the next scene • You can perform the same operation with the zoom lever.
⑨	<<CAM	Switches to the camera (recording) mode.
⑩	⏹	Stop (returns to index screen)
⑪	🗑	Deletes the currently displayed video.
⑫	MENU	Displays the menu screen

## Adjusting the Volume of Videos

The volume level can be adjusted using the "ADJ." dial.

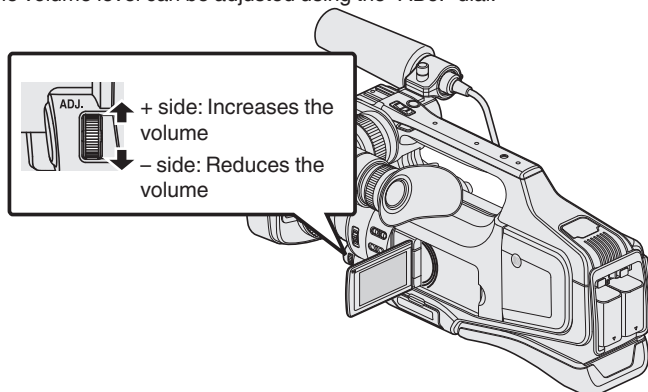

### Caution :

- Make a backup of important recorded data. It is recommended to copy your important recorded data to a DVD or other recording media for storage.
- This unit is a microcomputer-controlled device. Electrostatic discharge, external noise and interference (from a TV, a radio, etc.) might prevent it from functioning properly. In such a case, turn off the power, then remove the AC adapter and battery pack. This unit will be reset.
- Disclaimer
  - We shall not be held responsible for loss of recorded contents when recording videos/audio or playback cannot be operated due to malfunctions in this unit, provided parts, or SD card.
  - Once deleted, recorded contents (data), including data loss due to malfunctions in this unit, cannot be restored. Please be forewarned.
  - JVC will not be responsible for any lost data. Please be forewarned.
  - In order for quality improvement, defective recording medium is subject to be analyzed. Therefore, it may not be returned.

## Normal Playback

Plays back the recorded videos.

- 1 Check that the unit is in the video mode.

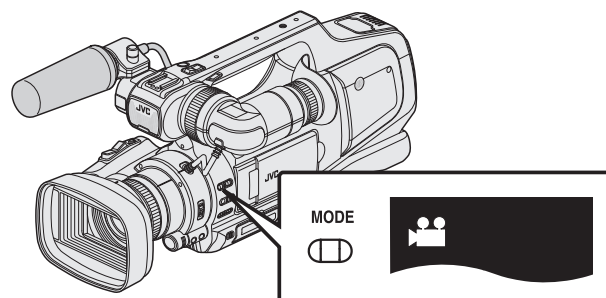

- Check if video mode is activated.
- If still image mode is activated, switch to video mode . "Selecting Video/Still Image Recording Mode" (p. 19)

- 2 Tap <<MEDIA to select the playback mode.

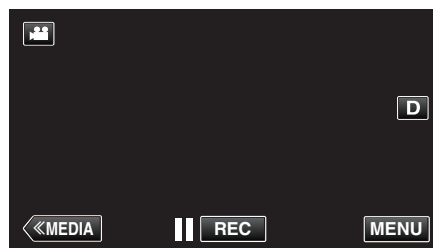

- 3 Tap on the file to start playback.

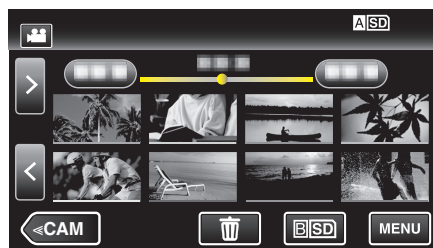

- Tap **A|SD**/**B|SD** to select the media for playback and change the index screen (thumbnail display).
- Tap to pause.
- Tap to return to the index screen.
- appears on the last image played back.
- Lines in different colors are displayed to distinguish the recording date.
- Images recorded in 50p mode and 50i mode are displayed on the index screen separately. To switch between the 50p mode and 50i mode index screen (thumbnail display), tap . In cases such as during Digest Playback or when playing back/editing a playlist, select the 50p mode and 50i mode before operating.





## DIGEST PLAYBACK

You can play back a digest of the recorded videos (Digest Playback). This is useful for checking the content of the videos quickly.

1 Check that the unit is in the video mode.

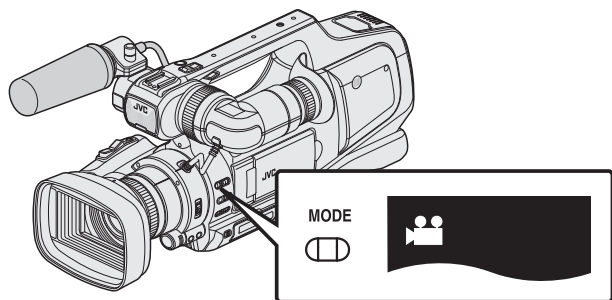

- Check if video mode is activated.
- If still image mode is activated, switch to video mode ().  
“Selecting Video/Still Image Recording Mode” (p. 19)

2 Tap <<MEDIA to select the playback mode.

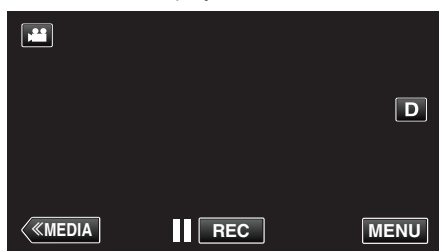

3 Tap “MENU”.



4 Tap “PLAYBACK SETTING”.

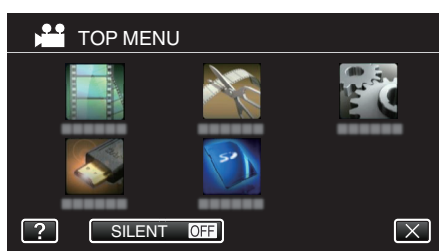

5 Tap “DIGEST PLAYBACK”.

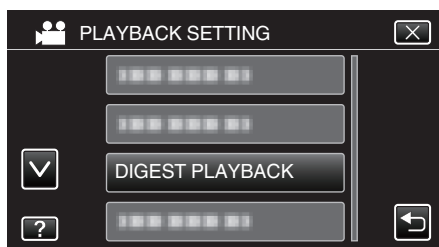

6 Tap to select a date for Digest Playback.

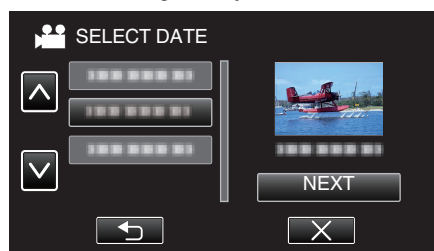

- After selecting a date, tap “NEXT”.
- When “ALL” is tapped, Digest Playback will be performed for all the dates.
- Tap X to exit the menu.
- Tap ↶ to return to the previous screen.

7 Select the Digest Playback time

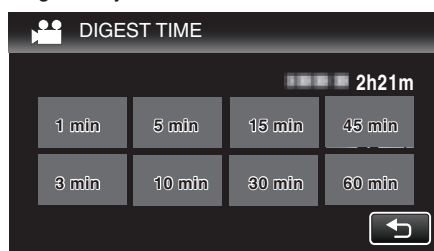

- The time display of Digest Playback varies according to the recording time.
- When it takes time (more than 2 seconds) for “DIGEST PLAYBACK” to start after selecting Digest Playback time, a progress status will be displayed.
- The Digest Playback time is only a guide.

8 Digest Playback starts.

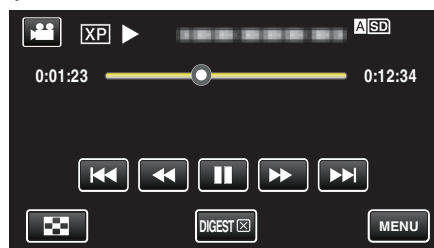

- Tap to pause.
- Tap to return to the index screen.
- Tap “DIGEST [X]” to return to the normal playback screen.
- Operations During Video Playback  
“Operation Buttons for Video Playback” (p. 45)

9 Digest playback stops automatically, or display the next screen by tapping “MENU”.

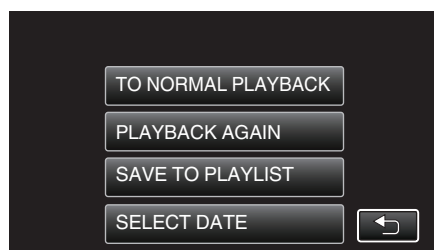

- TO NORMAL PLAYBACK: Starts normal playback.
- PLAYBACK AGAIN: Starts digest playback again.
- SAVE TO PLAYLIST: Saves the images of digest playback to the playlist.  
“PLAYBACK PLAYLIST” (p. 50)
- SELECT DATE: Returns to step 6.

## PLAYBACK PLAYLIST

Play back the playlists that you have created.

1 Check that the unit is in the video mode.

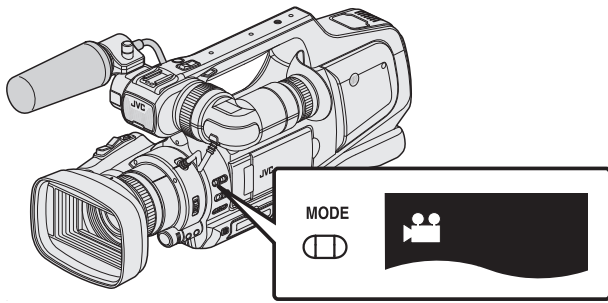

- Check if video mode is activated.
  - If still image mode is activated, switch to video mode .
- “Selecting Video/Still Image Recording Mode” (p. 19)

2 Tap <<MEDIA to select the playback mode.

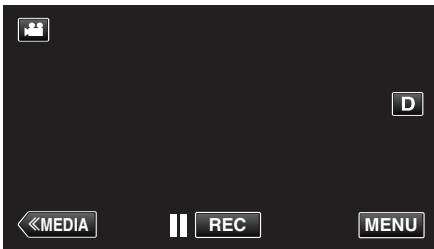

3 Tap “MENU”.

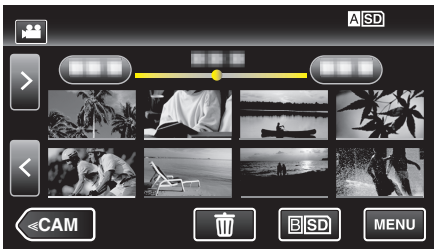

4 Tap “PLAYBACK SETTING”.

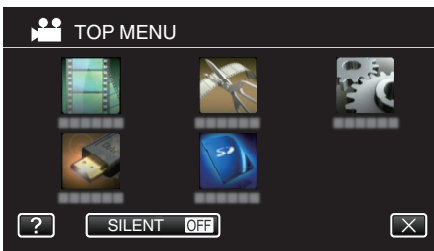

5 Tap “PLAYBACK PLAYLIST”.

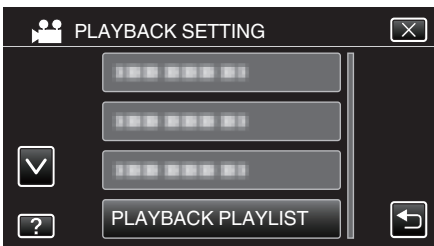

6 Tap to select a playlist.

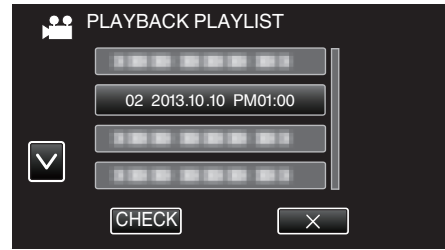

- Playback of the playlist starts.
- “Playing Back Videos” (p. 45)
- Tap to return to the index screen.
  - Tap “CHECK” and select a playlist to check its content. After checking, tap .
  - Playlists with a (Digest Playback) icon are the playlists created during Digest Playback.

Creating Playlists: \_\_\_\_\_  
 “Creating Playlists from the Recorded Videos” (p. 63)

### PLAYBACK OTHER FILE

The management information of a video may be damaged if recording is not performed correctly, such as turning off the power in the middle of recording. You can perform the following operations to play back the videos with defective management information.

1 Check that the unit is in the video mode.

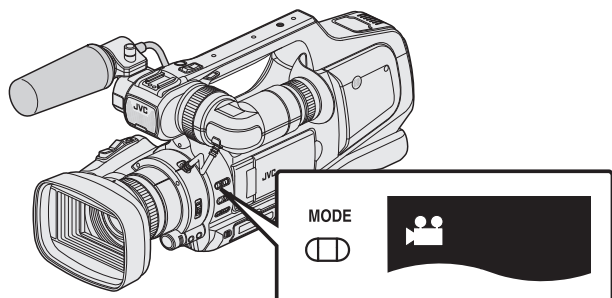

- Check if video mode is activated.
  - If still image mode is activated, switch to video mode .
- “Selecting Video/Still Image Recording Mode” (p. 19)

2 Tap <<MEDIA to select the playback mode.

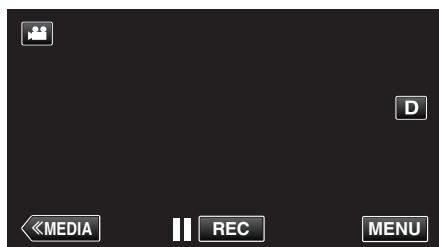

3 Tap “MENU”.



4 Tap “PLAYBACK SETTING”.

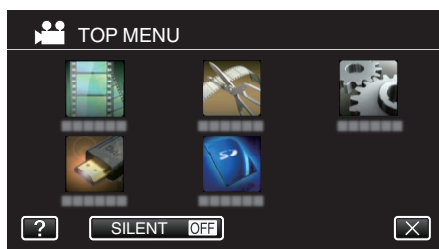

5 Tap “PLAYBACK OTHER FILE”.

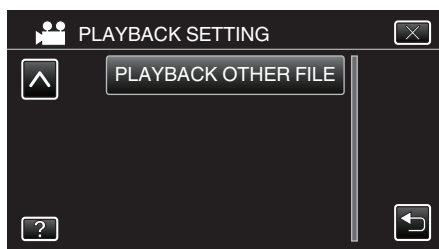

6 Tap on the file to start playback.



“Playing Back Videos” (p. 45)

**Memo :**



- An MTS file is created in the EXTMOV folder when management information is corrupted.
- Depending on the condition of the damaged file, playback might fail or may not run smoothly.

## Playing Back Still Images

You can select and play back the recorded still images from an index screen (thumbnail display).

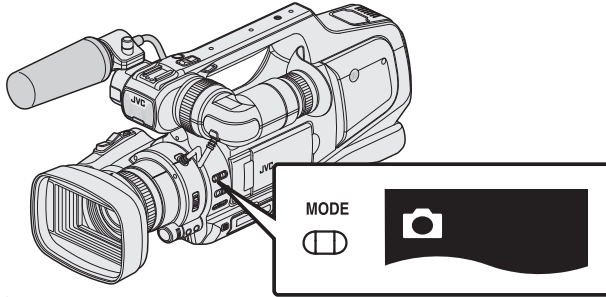
1 Check that the unit is in the still image mode.



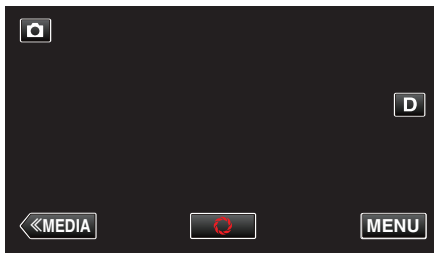

- Check if still image mode  is activated.
  - If video mode  is activated, switch to still image mode .
- “Selecting Video/Still Image Recording Mode” (p. 19)

2 Tap <<MEDIA to select the playback mode.

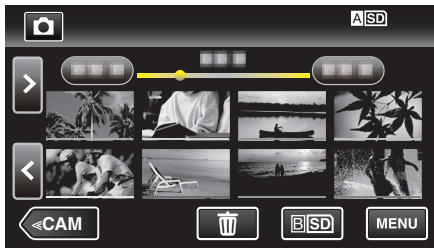

3 Tap on the file to start playback.





- Tap **A/SD/B/SD** to select the media for playback and change the index screen (thumbnail display).
- Tap  to return to the index screen.
-  appears on the last image played back.
- Lines in different colors are displayed to distinguish the recording date.

## Operation Buttons for Still Image Playback

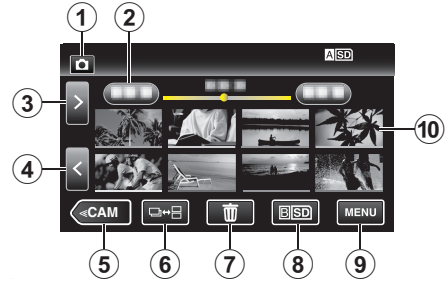
### During Index Screen Display



	Display	Description
①	Video/Still Image Mode	Switches between video (50i/50p) and still image modes.
②	Date	Moves to the previous/next date
③	>	Displays the next index screen (thumbnail display) <ul style="list-style-type: none"> <li>• You can perform the same operation with the zoom lever.</li> </ul>
④	<	Displays the previous index screen (thumbnail display) <ul style="list-style-type: none"> <li>• You can perform the same operation with the zoom lever.</li> </ul>
⑤	<<CAM	Switches to the camera (recording) mode.
⑥		Still images that are recorded continuously within 2 seconds or with the continuous shooting mode will be grouped together and displayed with a green frame on a separate index screen. The index screen changes between the normal index screen and group index screen with every tap of the button.
⑦		Displays the index screen (thumbnail display) to perform deletion
⑧	<b>A/SD/B/SD</b>	Switches between the SD card slots.
⑨	MENU	Displays the menu screen
⑩	File (Still Image)	Tap on thumbnail - Starts playback Drag to right - Scrolls to the right to show the previous index screen (thumbnail display) Drag to left - Scrolls to the left to show the next index screen (thumbnail display)

**During Still Image Playback**

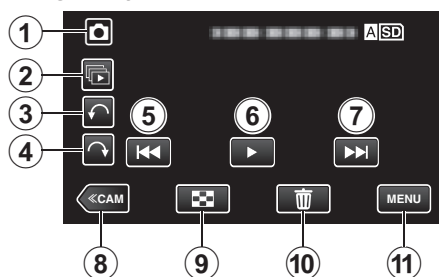

	Display	Description
①	Video/Still Image Mode	Switches between video (50i/50p) and still image modes.
②		Continuous playback of still images that are recorded with the continuous shooting mode.
③		Rotates to the left (rotates by -90° with each tap)
④		Rotates to the right (rotates by 90° with each tap)
⑤		Returns to the previous still image • You can perform the same operation with the zoom lever.
⑥		Starts/pauses slideshow “Slideshow Playback” (☞ p. 53)
⑦		Advances to the next still image • You can perform the same operation with the zoom lever.
⑧	<<CAM	Switches to the camera (recording) mode.
⑨		Returns to index screen
⑩		Deletes the currently displayed still image.
⑪	MENU	Displays the menu screen

**Memo :**

- Tap or drag on the operation area of the touch screen.
- Operations buttons on the touch screen disappear if the unit is not operated for about 5 seconds. Tap on the screen to display the operation buttons again.
- You can rotate a still image 90° to the right or left during playback. Rotation applies to the on-screen display only.
- You can search for a specific file by the recording date. This is useful when searching from a large number of files.  
 “Searching for a Specific Video/Still Image by Date” (☞ p. 54)

**Caution :**

- This unit is a microcomputer-controlled device. Electrostatic discharge, external noise and interference (from a TV, a radio, etc.) might prevent it from functioning properly. In such a case, turn off the power, then remove the AC adapter and battery pack. This unit will be reset.

**Slideshow Playback**

Still images can be played back in a slideshow.  
 Tap during still image playback to start the slideshow.

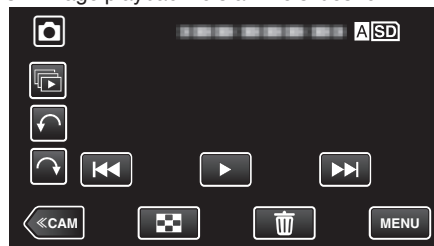

“Operation Buttons for Still Image Playback” (☞ p. 52)

**Memo :**

- Effects can be added to the transitions in slideshow playback.  
 “SLIDE SHOW EFFECTS” (☞ p. 105)

## Searching for a Specific Video/Still Image by Date

When there is a large number of recorded videos and still images, it is difficult to look for the desired file from the index screen. Use the search function to find the file you want. You can search and play videos or still images according to recording dates.

1 Tap <<MEDIA to select the playback mode.

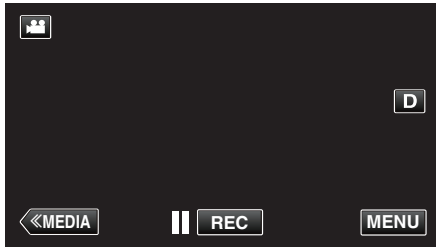

2 Tap "MENU".



- Tap **A/SD**/**B/SD** to select the media for playback and change the index screen (thumbnail display).
- Searching can be performed in both the video and still image modes.  
\*The image shows the video mode.

3 Tap "PLAYBACK SETTING".

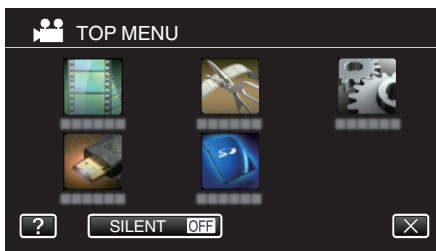

4 Tap "SEARCH DATE".

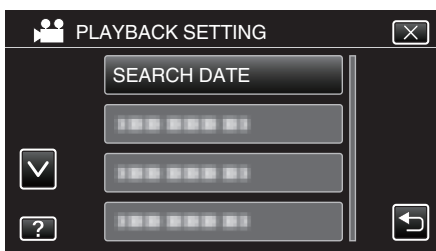

5 Tap a recording date, then tap "NEXT".

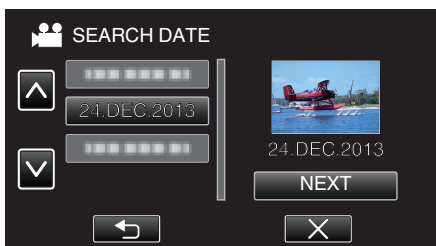

- Tap again to cancel the selected date.

6 Tap on the file to start playback.



- You can select videos in the video mode and still images in the still image mode.
- Only the files recorded on the selected date are displayed.
- Tap X to stop searching and return to the index screen (thumbnail display).

Deleting Files of a Selected Date : \_\_\_\_\_  
Tap **X** on the index screen (thumbnail display) to delete unwanted files. "Deleting Unwanted Files" (p. 59)

## Connecting to and Viewing on TV

You can connect this unit to a TV for playback. The image quality on TV varies with the type of TV and the connecting cable. Select the connector that best suits your TV.

- Refer also to the instruction manual of the TV in use.

“Connecting via the HDMI Connector” (☞ p. 55)

“Connecting via the AV Connector” (☞ p. 57)

- To display the date and time on TV, set both “DISPLAY DATE/TIME” and “DISPLAY ON TV” to “ON”.

“DISPLAY DATE/TIME” (☞ p. 104)

“DISPLAY ON TV” (☞ p. 108)

## Unnatural Displays on TV

Trouble	Action
Images do not appear on the TV properly.	<ul style="list-style-type: none"> <li>• Disconnect the cable and connect again.</li> <li>• Turn off and on this unit again.</li> <li>• Images may not appear properly when the remaining battery power is low. Use an AC adapter.</li> </ul>
Images are projected vertically on the TV.	<ul style="list-style-type: none"> <li>• Set “VIDEO OUTPUT” in the “CONNECTION SETTINGS” menu to “4:3”.</li> </ul> <p>“VIDEO OUTPUT” (☞ p. 108)</p>
Images are projected horizontally on the TV.	<ul style="list-style-type: none"> <li>• Adjust the TV’s screen accordingly.</li> </ul>
The color of images looks strange.	<ul style="list-style-type: none"> <li>• Adjust the TV’s screen accordingly.</li> </ul>
HDMI-CEC functions do not work properly, and the TV does not work in conjunction with this unit.	<ul style="list-style-type: none"> <li>• TVs may operate differently depending on the specifications, even if they are HDMI-CEC compliant. Therefore, the HDMI-CEC functions of this unit cannot be guaranteed to operate in combination with all the TVs. In such cases, set “HDMI CONTROL” to “OFF”.</li> </ul> <p>“HDMI CONTROL” (☞ p. 108)</p>
The language on the display changed.	<ul style="list-style-type: none"> <li>• It may occur when you connect this unit to a TV with different language setting using an HDMI cable.</li> </ul>

### Caution :

- Do not remove the recording medium or perform any other operation (such as turning off the power) while accessing files. Also, be sure to use the provided AC adapter, as the data on the recording medium may be corrupted if the battery becomes exhausted during operation. If the data on the recording medium becomes corrupted, format the recording medium to use the medium again.

## Connecting via the HDMI Connector

If you are using an HDTV, you can play back in HD quality by connecting to the HDMI connector.

- Use a High Speed HDMI cable as the HDMI cable.
- Refer also to the instruction manual of the TV in use.

1 Connect to a TV.

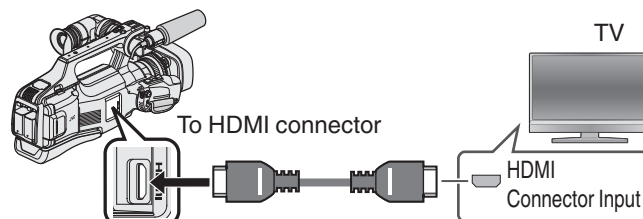

- Turn off the power of the camera.

2 Connect the AC adapter to this unit.

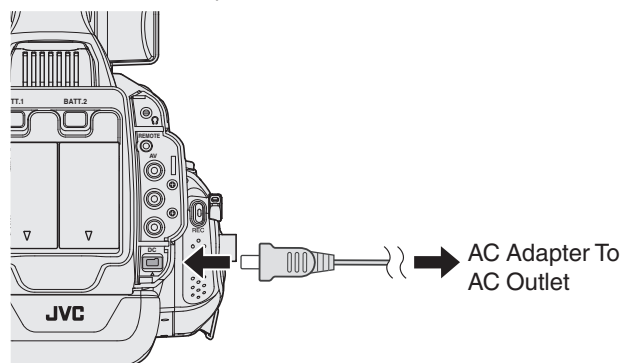

3 Set the “STANDBY/ON OFF” switch to “ON”.

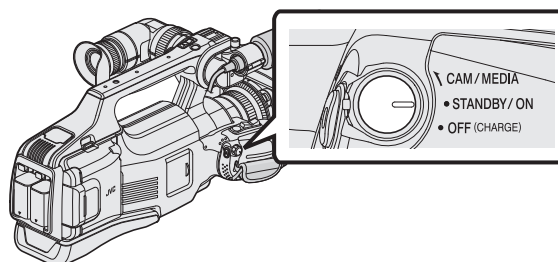

4 Press the external input button on the TV to switch to the input from this unit via the connected connector.

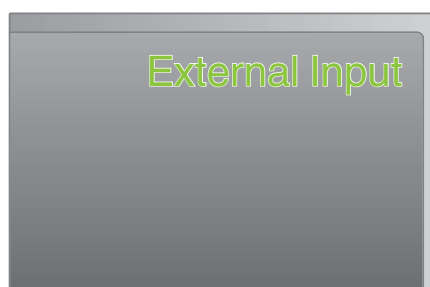

### 5 Play back a file.



“Playing Back Videos” (☞ p. 45)

“Playing Back Still Images” (☞ p. 52)

#### Memo :

- Change the settings in “HDMI OUTPUT” according to the connection. “HDMI OUTPUT” (☞ p. 108)
- When connected to the TV via the HDMI cable, images and sounds may not be output properly depending on the TV connected. In such cases, perform the following operations.
  - 1) Disconnect the HDMI cable and connect it again.
  - 2) Turn off and on this unit again.
- For questions about the TV or method of connection, contact your TV’s manufacturer.

## Operating in Conjunction with TV via HDMI

Connecting this unit to an HDMI-CEC-enabled TV using the HDMI cable allows linked operations with the TV to be performed.

- HDMI-CEC (Consumer Electronics Control) is an industry standard that enables interoperability between HDMI-CEC compliant devices that are connected via HDMI cables.

#### Memo :

- Not all HDMI-control devices comply with the HDMI-CEC standard. The HDMI control function of this unit will not work when connected to these devices.
- This unit is not guaranteed to operate with all HDMI-CEC-enabled devices.
- Depending on the specifications of each HDMI-CEC-enabled device, some functions may not work with this unit. (For details, refer to the instruction manual of the TV.)
- Unintended operations may occur with some connected devices. In these cases, set “HDMI CONTROL” to “OFF”.

“HDMI CONTROL” (☞ p. 108)

## Preparations

- Connect an HDMI cable between this unit and the TV. “Connecting via the HDMI Connector” (☞ p. 55)
- Turn on the TV and set the HDMI-CEC related setting to “ON”. (For details, refer to the instruction manual of the TV.)
- Turn on this unit and set “HDMI CONTROL” in the “COMMON” menu to “ON”.

“HDMI CONTROL” (☞ p. 108)

## Operation Method 1

- 1 Turn on this unit.
- 2 Select the playback mode.
- 3 Connect the HDMI cable.
  - TV turns on automatically and switches to HDMI input mode when this unit is turned on.

## Operation Method 2

- 1 Turn off the TV.
  - This unit turns off automatically.

#### Memo :

- Depending on the TV connected, the display language of this unit will automatically switch to the language that is selected for the TV when this unit is turned on. (This is applicable only if this unit supports the language selected for the TV.) To use this unit with a language that differs from the display language of the TV, set “HDMI CONTROL” to “OFF”.
- The display language of the TV will not switch automatically, even if the display language of this unit is changed.
- These functions may not work correctly when devices such as amplifier and selector are connected. In such cases, set “HDMI CONTROL” to “OFF”.
- If HDMI-CEC does not work properly, turn off and on this unit again.



### Connecting via the AV Connector

To playback videos on TV, connect the provided AV cable to the AV connector of this unit.

- Refer also to the instruction manual of the TV in use.

1 Connect to a TV.

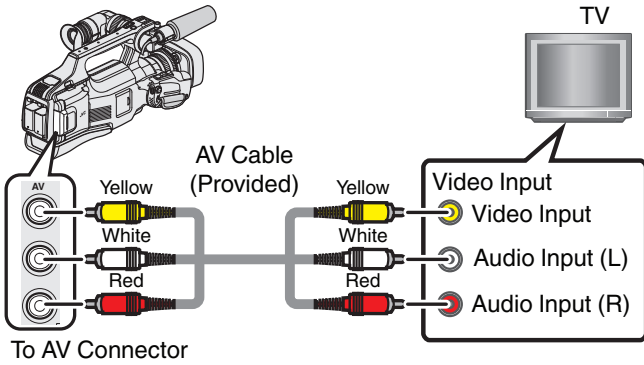

- Turn off the power of the camera.

2 Connect the AC adapter to this unit.

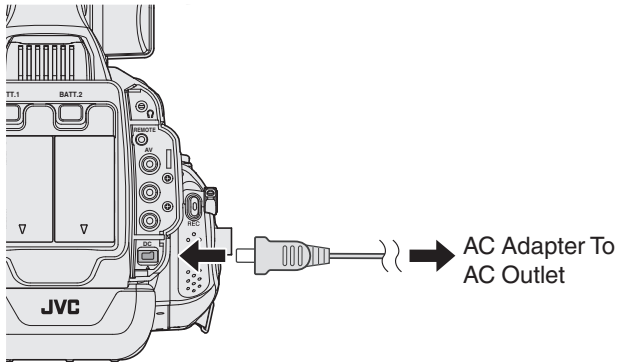

3 Set the "STANDBY/ON OFF" switch to "ON".

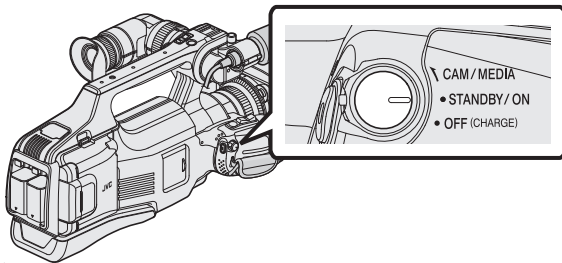

4 Press the external input button on the TV to switch to the input from this unit via the connected connector.

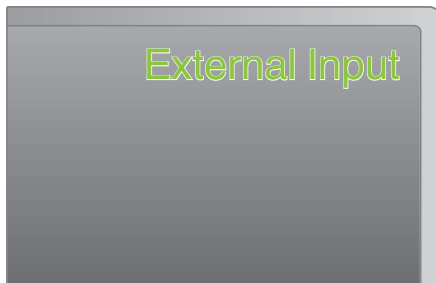

5 Play back a file.



"Playing Back Videos" (☞ p. 45)

"Playing Back Still Images" (☞ p. 52)

**Memo :**

- For questions about the TV or method of connection, contact your TV's manufacturer.

## Playing Back a DVD or Blu-ray Disc Created on this Unit

BD/DVDs created using the backup function on this unit can be played back on TV using an optional DVD writer (DVDs only) with playback function (CU-VD50U) or a normal BD/DVD player. DVDs can also be played back on this unit by connecting the optional DVD writer with playback function.

“Creating Discs with a BD Writer (External Blu-ray Drive)” (p. 69)

“Creating Discs with a DVD Writer” (p. 77)

- For details on how to play back on a normal DVD or Blu-ray disc player, refer to the instruction manual of the player.

Playback Device	DVD (AVCHD format)	Blu-ray Disc
DVD writer connected to this unit	✓	-
BD writer (external Blu-ray drive) connected to this unit	✓	✓
DVD player/ DVD recorder	✓*	-
Blu-ray player/ Blu-ray recorder	✓*	✓
DVD writer with playback function (CU-VD50U)	✓	-

\*Only for AVCHD compatible devices

### Caution :

- DVDs that are created in AVCHD format cannot be played back on DVD players with standard quality. You may not be able to remove the disc from the player.

## Digest Playback on a Blu-ray or DVD Player

You can play back a few seconds from each scene of the recorded videos in the created disc.

- Load the created disc on a player.
- Select “DIGEST PLAYBACK” on the TV.
  - The digest is played back continuously.

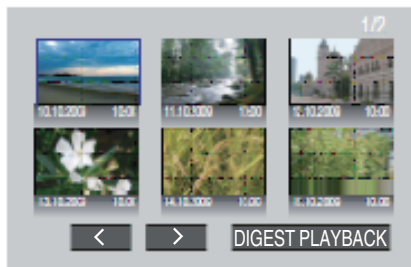

(The screen does not appear on this unit.)

### Memo :

- To normal playback/To index menu
  - Press the top menu button on the remote control of the player during digest playback.
  - Select the desired item.
- Digest Playback is not available when playing back by connecting this unit to a DVD writer or BD writer.

## Deleting Unwanted Files

Delete unwanted videos and still images when the space in the recording media is running out.

Doing so frees up more space in the recording media.

“Deleting the Currently Displayed File” (p. 59)

“Deleting Selected Files” (p. 59)

### Memo :

- Deleted files cannot be restored.
  - When files in a playlist are deleted, the playlist changes.
  - Files that are protected cannot be deleted.  
Release protection before deleting the file.
- “Protecting Files” (p. 60)
- Be sure to back up important files on a computer.
- “Copying to Mac Computer” (p. 94)

## Deleting the Currently Displayed File

Deletes the currently displayed file.

### Caution :

- Deleted files cannot be restored.

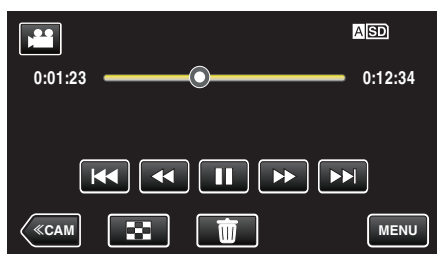

1 Tap .

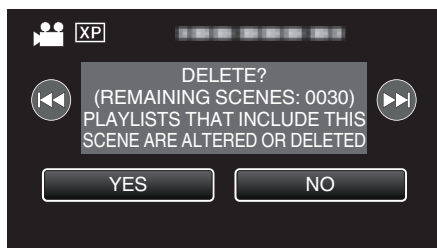

- While the video mode is shown in the image, the same operations apply for the still image mode.

2 Tap “YES”.



- Tap  /  to select the previous or next file.
- When no file remains, the screen returns to the index screen.

## Deleting Selected Files

Deletes the selected files.

### Caution :

- Deleted files cannot be restored.

1 Select video or still image mode.

2 Tap  to select the playback mode.

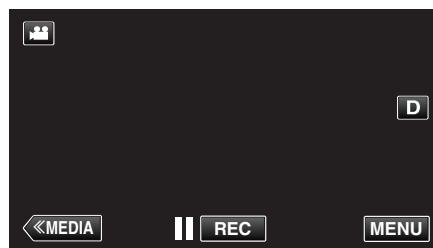

- While the video mode is shown in the image, the same operations apply for the still image mode.

3 Tap .



4 Tap on the files to delete.



- ✓ appears on the selected files.  
To remove ✓ from a file, tap on the file again.
- Tap “SEL ALL” to select all files.
- Tap “REL ALL” to release all selections.

5 Tap “SET”.



6 Tap “EXECUTE” to confirm the deletion.

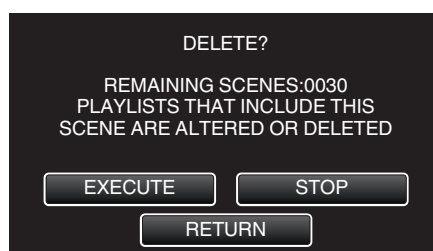

- After deleting is complete, tap “OK”.
- To cancel the deletion, tap “QUIT”.

## Protecting Files

Prevent important videos/still images from being deleted accidentally by protecting them.

“Protecting/Releasing Protection of the Currently Displayed File”

(☞ p. 60)

“Protecting/Releasing Protection of Selected Files” (☞ p. 60)

### Caution :

- When the recording media is formatted, even the protected files will be deleted.

## Protecting/Releasing Protection of the Currently Displayed File

Protects or releases protection of the currently displayed file.

- 1 Tap “MENU”.

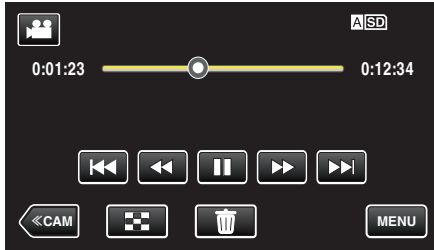

- 2 Tap “EDIT”.



- 3 Tap “PROTECT/CANCEL”.

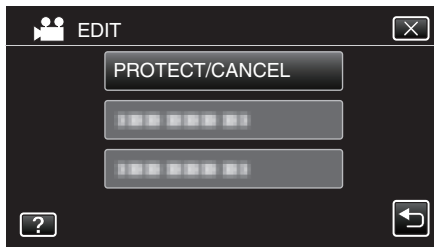

- 4 Tap “YES”.

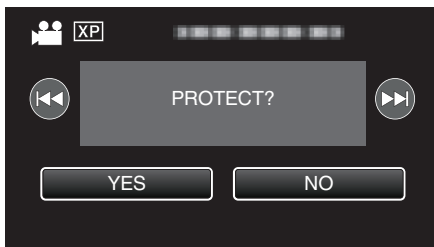

- Tap **◀◀/▶▶** to select the previous or next file.
- After setting, tap “OK”.

## Protecting/Releasing Protection of Selected Files

Protects or releases protection of the selected files.

- 1 Select video or still image mode.
- 2 Tap <<MEDIA to select the playback mode.

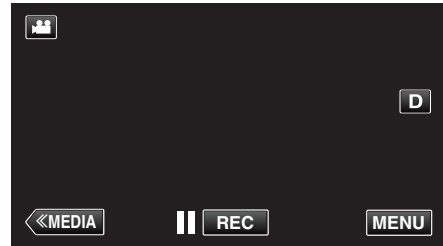

- 3 Tap “MENU”.

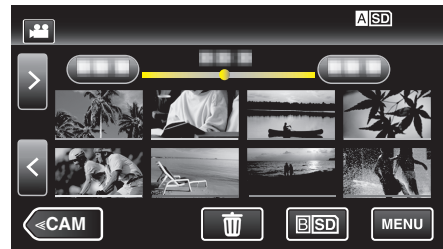

- 4 Tap “EDIT”.

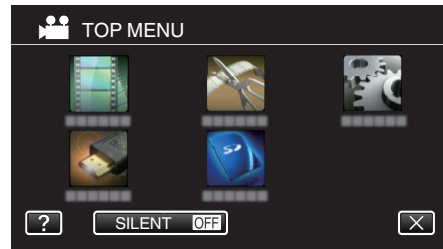

- 5 Tap “PROTECT/CANCEL”.

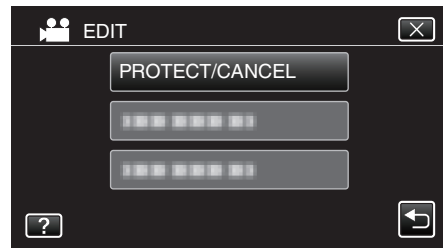

- 6 Tap on the files to protect or release protection of.

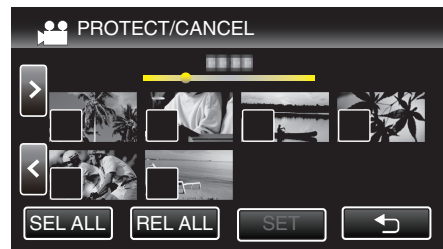

- ✓ appears on the selected files.  
To remove ✓ from a file, tap on the file again.
- On and ✓ are displayed on the files that are already protected.  
To release protection of a file, tap on the file such that ✓ is removed.
- Tap “SEL ALL” to select all files.
- Tap “REL ALL” to release all selections.

7 Tap "SET" to complete the setting.

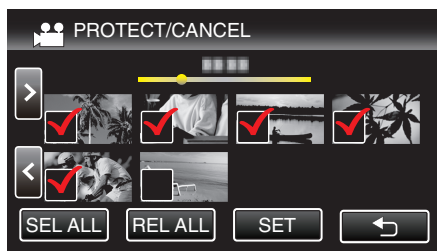

- Protect marks appear on the selected files.  
Protect marks disappear from the deselected files.

## Capturing a Still Image in the Video during Playback

You can capture still images of the scenes you like in the recorded videos.

1 Check that the unit is in the video mode.

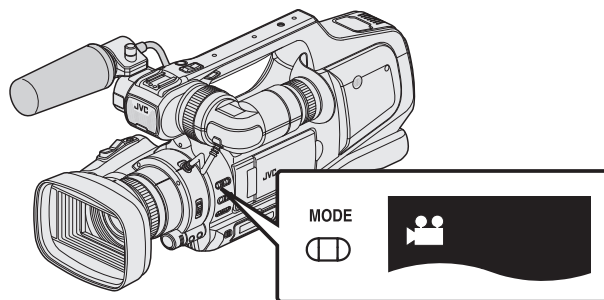

- Check if video mode is activated.
- If still image mode is activated, switch to video mode ()  
"Selecting Video/Still Image Recording Mode" (p. 19)

2 Tap <<MEDIA to select the playback mode.

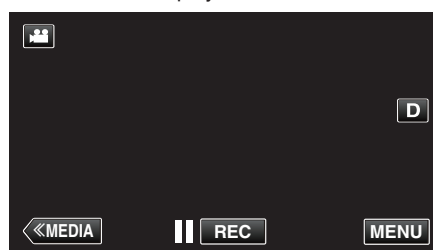

3 Tap on the desired video.



4 Tap pause at the desired scene during playback.

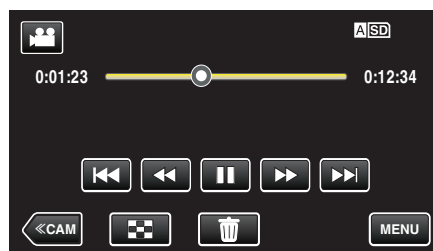

- After pausing the video, you can fine-tune the point to capture by tapping forward slow-motion and reverse slow-motion .

5 Press the SNAPSHOT button.

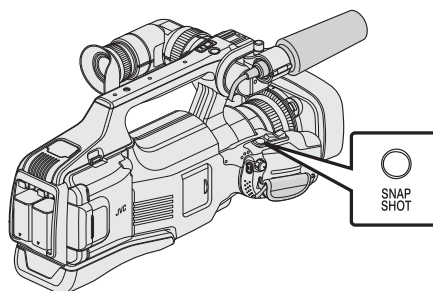

### Memo :

- Still images are captured with a size of 1920x1080.
- Captured still images are stored in the media where the video is being played back from.

## Capturing a Required Part in the Video (TRIMMING)

Select the required part of a video and save it as a new video file.

- The original video remains in its existing location.

1 Check that the unit is in the video mode.

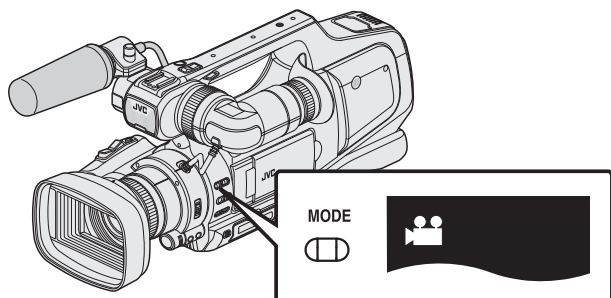

- Check if video mode is activated.
  - If still image mode is activated, switch to video mode .
- “Selecting Video/Still Image Recording Mode” (p. 19)

2 Tap <<MEDIA to select the playback mode.

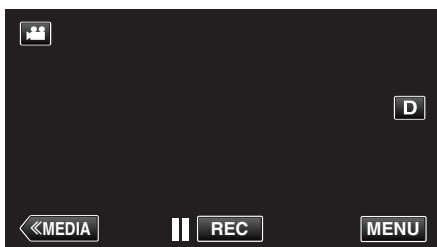

3 Tap “MENU”.



4 Tap “EDIT”.

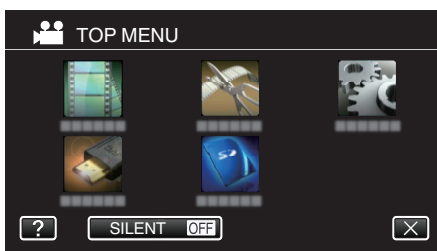

5 Tap “TRIMMING”.

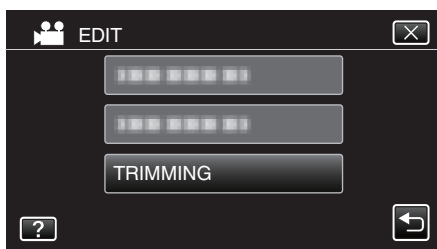

6 Tap the video to edit.



7 Tap to pause playback at the desired start point, then tap “A”.

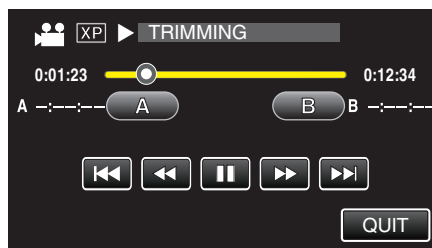

- When “A” is tapped, the start point is set.
- After setting the start point, tap to continue playback.

8 Tap to pause playback at the desired end point, then tap “B”.

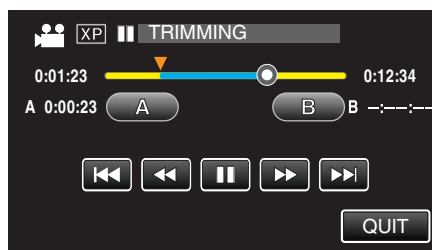

- When “B” is tapped, the end point is set.
- To reset the start or end point, tap “A” or “B” at the desired scene (position).

9 Tap “SET”.

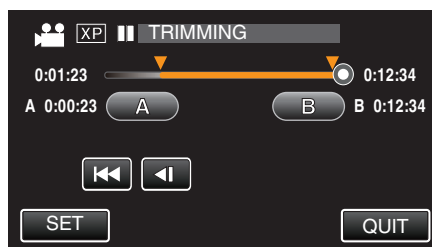

- When “SET” is tapped, the trimming area is confirmed.

10 Tap “YES”.

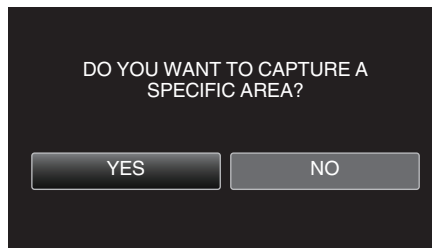

- After copying, tap “OK”.
- When copying finishes, the copied file is added to the index screen.

**Memo :** \_\_\_\_\_

- The division point may deviate slightly from the selected scene.

## Creating Playlists from the Recorded Videos

A list created by selecting your favorite videos from the recorded ones is called a playlist.

By creating a playlist, you can play back only your favorite videos in the order you like.

The original video file remains even when it is registered to a playlist.

- To create a new playlist

“Creating Playlists with Selected Files” (p. 63)

“Creating Playlists by Date” (p. 64)

- To edit or delete a created playlist

“Editing Playlists” (p. 66)

“Deleting Playlists” (p. 68)

### Memo :

- When a video file is deleted or moved, the same file will be removed from the playlist.

## Creating Playlists with Selected Files

Create a playlist by arranging the files one by one.

- 1 Check that the unit is in the video mode.

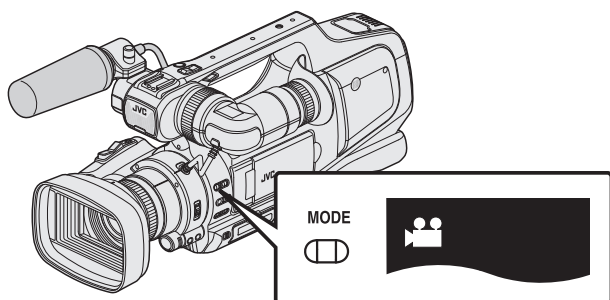

- Check if video mode is activated.
  - If still image mode is activated, switch to video mode ().
- “Selecting Video/Still Image Recording Mode” (p. 19)

- 2 Tap <<MEDIA to select the playback mode.

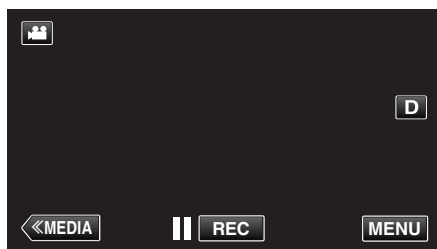

- 3 Tap “MENU”.



- 4 Tap “EDIT”.

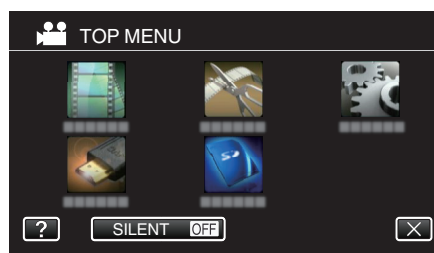

- 5 Tap “EDIT PLAYLIST”.

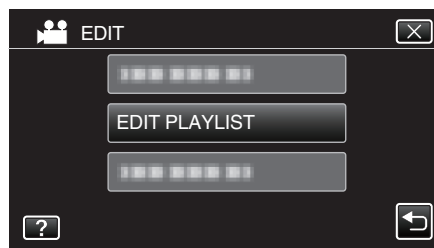

- 6 Tap “NEW LIST”.

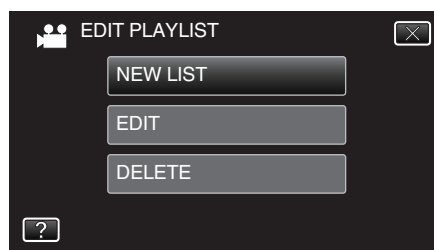

- 7 Tap “CREATE FROM SCENE”.

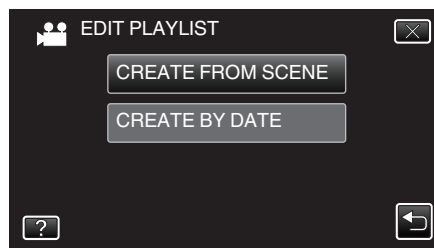

- 8 Tap on the video to add to playlist.



- appears on the selected video.
- Tap on the selected video again to check the video. After checking, tap .
- Tap or move the zoom lever to display the previous/next video.
- indicates the size of the video.
- Video files of different sizes cannot be imported to the same playlist.

9 Tap "ADD" to insert the video onto the lower section.

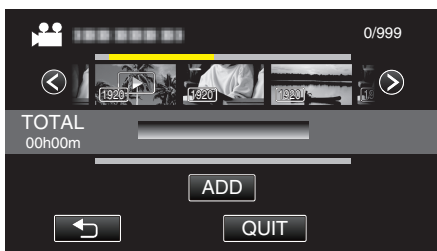

- Repeat steps 8-9 and arrange the videos in the playlist.
- To change the position of a video in the playlist (lower row), select the insertion point with ←/→ after step 8 and tap "ADD".
- ▶ appears when the inserted video is selected. Tap ↶ to deselect.
- Tap on the selected video again to check the video. After checking, tap ↶.
- To delete of a video in the playlist (lower row), tap the video, then tap "CANCEL".
- 1920 indicates the size of the video.

10 After arranging, tap "SAVE".



11 Tap "YES".

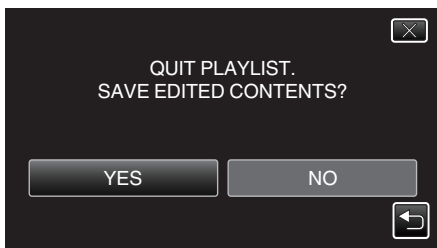

**Memo :**

- Tap X on each screen to exit the menu.

**Creating Playlists by Date**

Create a playlist by arranging multiple files according to recording date.

1 Check that the unit is in the video mode.

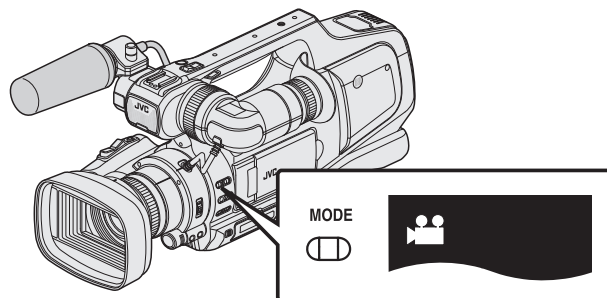

- Check if video mode is activated.
- If still image mode is activated, switch to video mode. "Selecting Video/Still Image Recording Mode" (p. 19)

2 Tap <<MEDIA to select the playback mode.

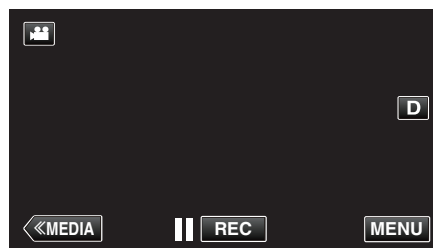

3 Tap "MENU".



4 Tap "EDIT".

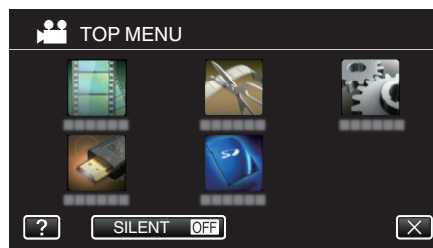

5 Tap "EDIT PLAYLIST".

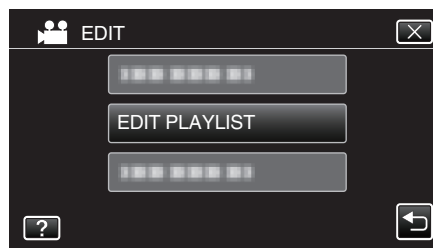



- 6 Tap "NEW LIST".

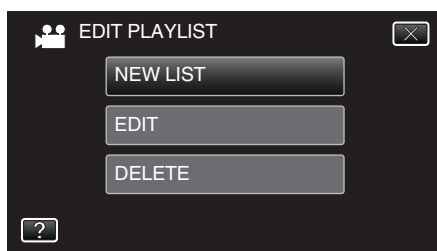

- 7 Tap "CREATE BY DATE".

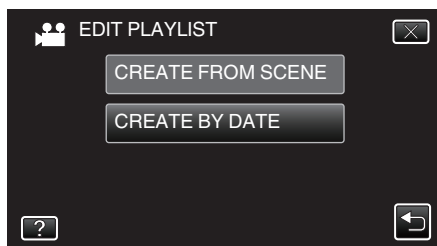

- 8 Tap on the video of the date to add to playlist.

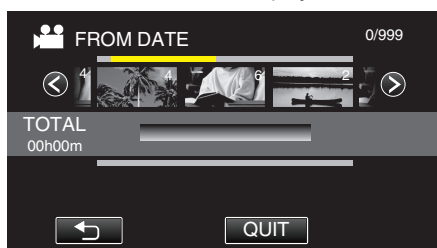

- ▶ appears on the selected video.
- Tap on the selected video again to check all the videos of the same date. After checking, tap ↶.
- Tap </> or move the zoom lever to display the previous/next video.
- The number on the video indicates the number of videos recorded on the same day.

- 9 Tap "ADD" to insert the video onto the lower section.

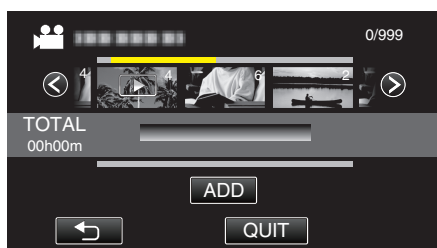

- Repeat steps 8-9 and arrange the videos in the playlist.
- To change the position of a video in the playlist (lower row), select the insertion point with ←/→ after step 8 and tap "ADD".
- ▶ appears when the inserted video is selected. Tap ↶ to deselect.
- Tap on the selected video again to check all the videos of the same date. After checking, tap ↶.
- To delete of a video in the playlist (lower row), tap the video, then tap "CANCEL".

- 10 After arranging, tap "SAVE".

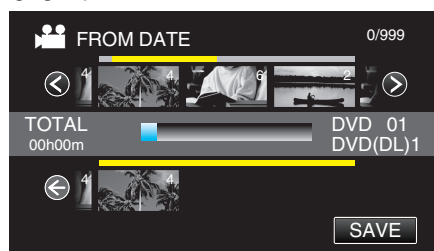

- 11 Tap "YES".

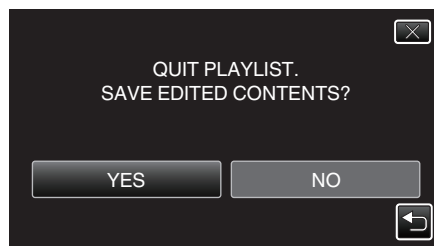

**Memo :**

- Tap X on each screen to exit the menu.

## Editing Playlists

You can change the content of a created playlist. However, the playlists created from Digest Playback cannot be changed.

- 1 Check that the unit is in the video mode.

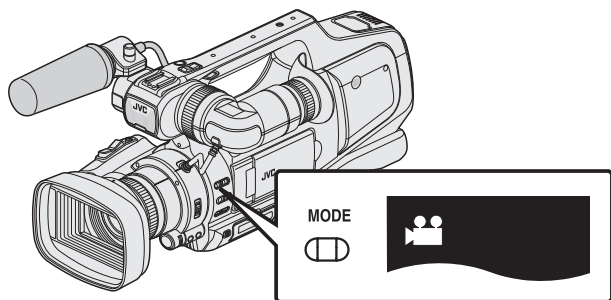

- Check if video mode is activated.
- If still image mode is activated, switch to video mode . "Selecting Video/Still Image Recording Mode" (p. 19)

- 2 Tap <<MEDIA to select the playback mode.

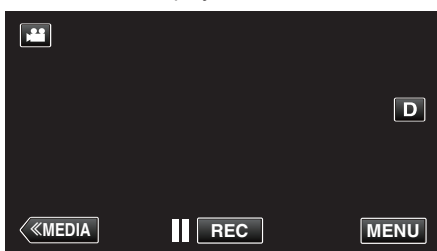

- 3 Tap "MENU".



- 4 Tap "EDIT".

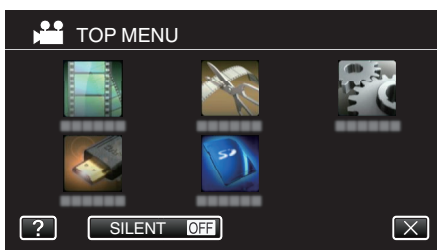

- 5 Tap "EDIT PLAYLIST".

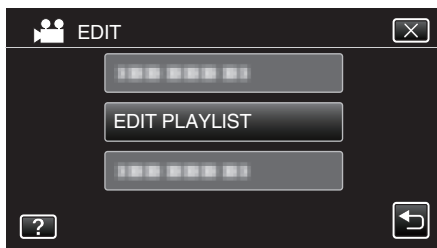

- 6 Tap "EDIT".

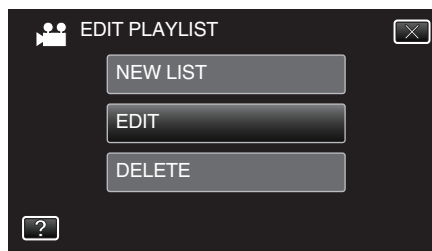

- 7 Tap on the playlist to edit, and tap "NEXT".

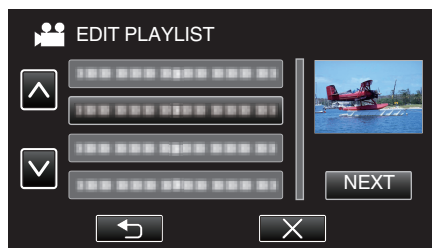

- 8 Tap on the video (upper row) to arrange in the playlist.

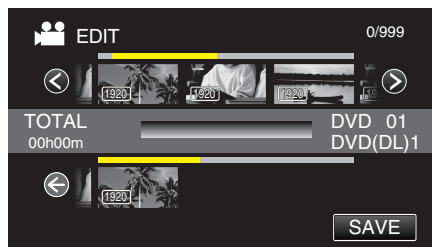

- appears on the selected video.
- Tap on the selected video again to check the video. After checking, tap .
- Tap or to move the zoom lever to display the previous/next video.
- indicates the size of the video.

- 9 Tap "ADD" to insert the video onto the lower section.

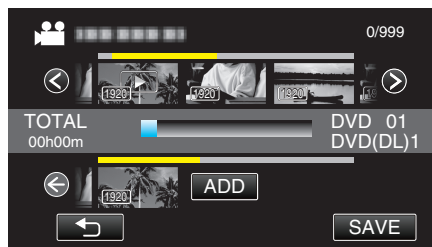

- Repeat steps 8-9 and arrange the videos in the playlist.
- To change the position of a video in the playlist (lower row), select the insertion point with / after step 8 and tap "ADD".
- appears when the inserted video is selected. Tap to deselect.
- Tap on the selected video again to check the video. After checking, tap .
- To delete of a video in the playlist (lower row), tap the video, then tap "CANCEL".
- indicates the size of the video.

10 After arranging, tap "SAVE".

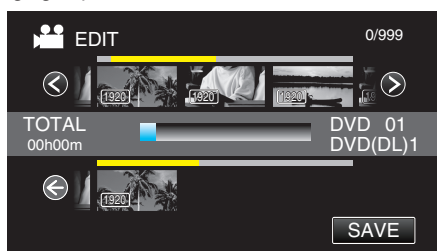

11 Tap "YES".

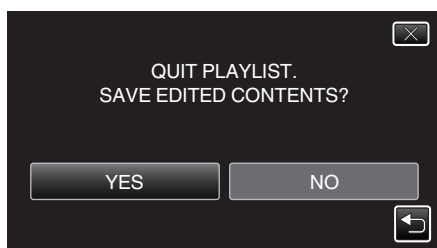

**Memo :**

- Tap X on each screen to exit the menu.

**Deleting Playlists**

Delete the playlists that you have created.

1 Check that the unit is in the video mode.

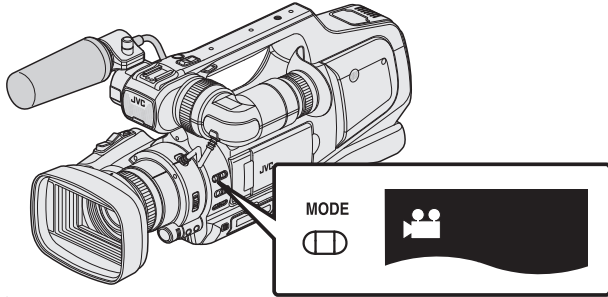

- Check if video mode is activated.
- If still image mode is activated, switch to video mode . "Selecting Video/Still Image Recording Mode" (p. 19)

2 Tap <<MEDIA to select the playback mode.

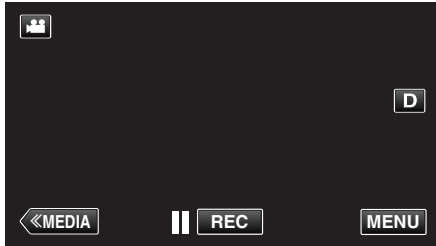

3 Tap "MENU".

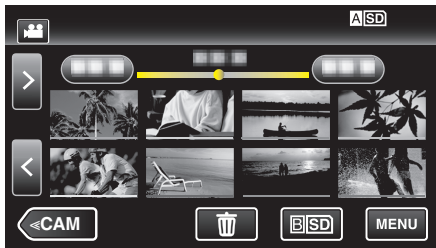

4 Tap "EDIT".

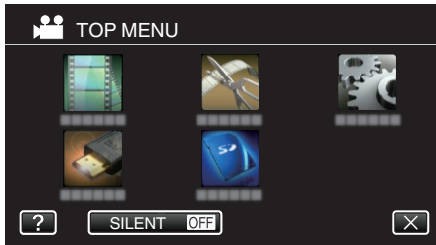

5 Tap "EDIT PLAYLIST".

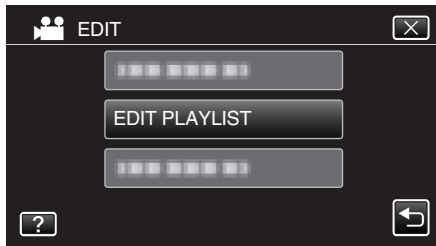

6 Tap "DELETE".

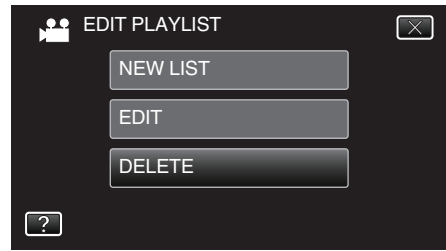

7 Tap on the playlist to delete, and tap "NEXT".

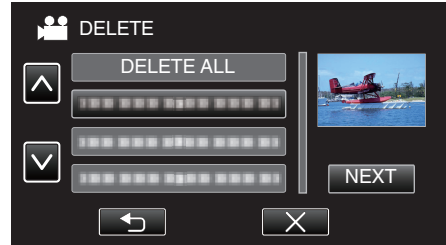

- All created playlists will be deleted when "DELETE ALL" is selected.

8 Tap "YES" to confirm the deletion.

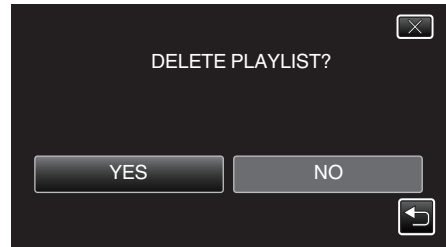

- After deleting, tap "OK".
- After deleting is complete, the screen returns to the delete playlist selection screen.

**Memo :**

- Tap X on each screen to exit the menu.

## Creating Discs with a BD Writer (External Blu-ray Drive)

\*The JVC external Blu-ray drive is known as “BD writer”.  
You can copy the recorded files to discs or play back the created discs using an optional BD writer (external Blu-ray drive).

### Compatible BD Writers (External Blu-ray Drives)

You can use BE12LU30 from LG. (as of April, 2013)

## Creating Discs with a BD Writer (External Blu-ray Drive)

### ■ Preparing a BD Writer (External Blu-ray Drive)

“Preparing a BD Writer (External Blu-ray Drive)” (p. 69)

### ■ Copying to Discs

“Copying All Files” (p. 70)

“Copying Files by Date” (p. 72)

“Copying Selected Playlists” (p. 73)

“Copying Selected Files” (p. 75)

Select and copy the desired videos or still images individually.

### ■ Other Operations

“Playing Back with a BD Writer (External Blu-ray Drive)” (p. 77)

### Memo :

- Discs in the DVD-Video format cannot be created.
- 50i videos, 50p videos and still images cannot be saved together on a disc.
- The recordable time on the disc varies according to the way of recording.
- When there are many files to back up, it may take time for the backup to be completed. Wait for a while as the access lamp appears blinking, which indicates normal operation.
- Date and time information as saved as subtitles in the created discs.

## Preparing a BD Writer (External Blu-ray Drive)

### Memo :

- When connecting this unit to the BD writer (external Blu ray drive), use an Mini-A (male) - B (male) USB conversion cable. Please note that the supplied USB cable cannot be used for this purpose.
- To use the USB cable provided with the BD writer (external Blu-ray drive), purchase the following USB conversion cable.

Part number: QAM0852-001 \* Mini-A (Male) – A (Female)

\*Consult your nearest service center.

- 1 Remove the AC adapter and battery pack from this unit.
- 2 Connect the USB cable and the AC adapter.

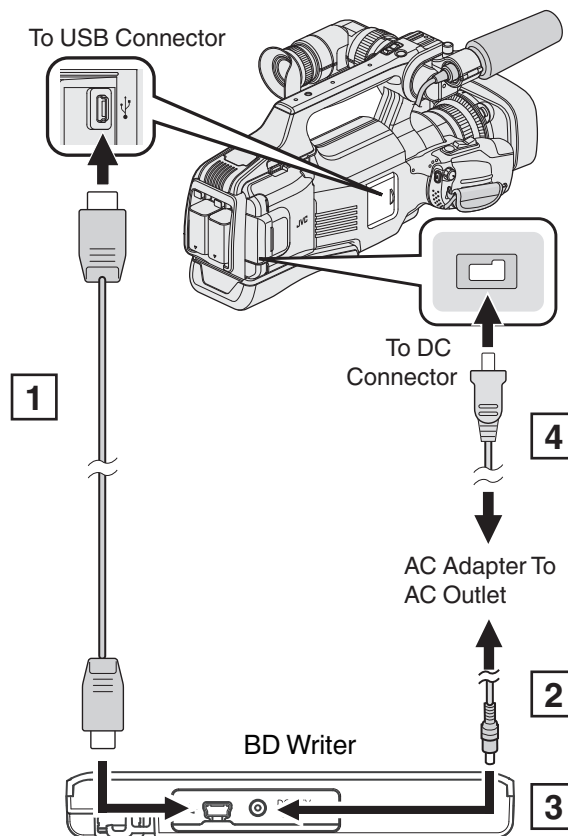

- 1 Connect the USB cable of the BD writer (external Blu-ray drive) to this unit.
- 2 Connect the AC adapter of the BD writer (external Blu-ray drive).
- 3 Turn on the BD writer (external Blu-ray drive).
- 4 Connect the AC adapter to this unit.
  - Refer also to the instruction manual of the BD writer (external Blu-ray drive).

- 3 Set the "STANDBY/ON OFF" switch to "ON".

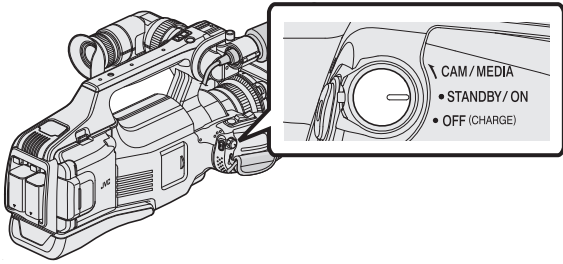

- When this unit is turned on, the "BACK-UP" menu appears.
- While the USB cable is connected, the "BACK-UP" menu is displayed.

- 4 Insert a new disc.

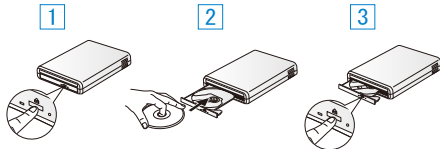

- 1 Press the eject button to open the disc tray.
- 2 Load a new disc properly.
- 3 Press the eject button to close the disc tray.

### Caution :

- Be sure to turn off the power when connecting the devices. Otherwise, electric shocks or malfunctions may occur.
- Do not connect the AC adapter provided with this unit to the BD writer.
- Do not connect the AC adapter provided with the BD writer to this unit.

## Creating a Disc

### Creating a Disc

- 1 Prepare a BD writer (external Blu-ray drive).
  - Insert a new disc into the BD writer (external Blu-ray drive). "Preparing a BD Writer (External Blu-ray Drive)" (p. 69)
- 2 Copy files to the disc with the following methods.
  - "Copying All Files" (p. 70)
  - "Copying Files by Date" (p. 72)
  - "Copying Selected Playlists" (p. 73)
  - "Copying Selected Files" (p. 75)

### Copying All Files

All videos or still images recorded on this unit will be copied. You can also select and copy only the videos or still images that have never been copied.

- 1 Select video or still image mode.
- 2 Tap "CREATE FROM ALL" (video) or "SAVE ALL" (still image).

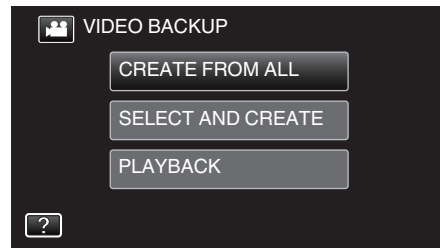

- While the video mode is shown in the image, the same operations apply for the still image mode.
- Tap the person icon to switch between the video (50i), video (50p), and still image modes. Switch to the mode in which you want to copy files.

- 3 Tap "Blu-ray DISC" or "DVD(AVCHD)".

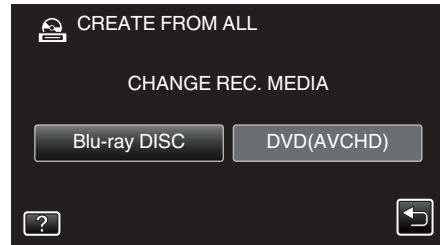

- The media changes to the tapped item. Select the appropriate setting according to the disc.
- Selecting "Blu-ray DISC" enables you to save videos in a Blu-ray disc in the high definition quality.
- Selecting "DVD(AVCHD)" enables you to save videos in a DVD in the high definition quality.
- If you have selected 50p videos in step 2, this screen will not appear because "Blu-ray DISC" is automatically selected.

- 4 Tap on the media to copy.

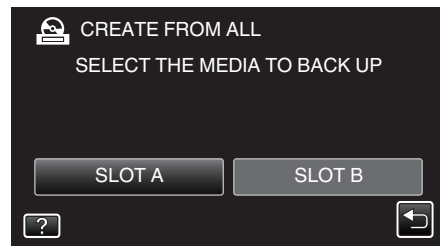

5 Tap the desired method.

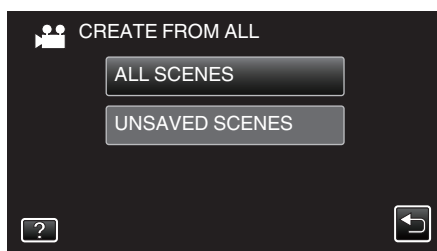

- **“ALL SCENES” (video)/“ALL IMAGES” (still image):**  
All videos or still images in this unit are copied.
- **“UNSAVED SCENES” (video)/“UNSAVED IMAGES” (still image):**  
Videos or still images that have never been copied are automatically selected and copied.

6 Tap “EXECUTE”.

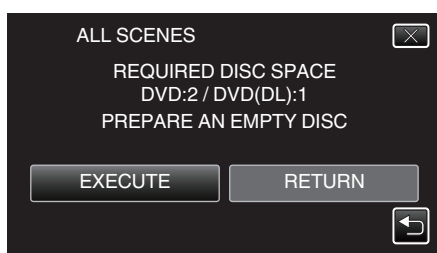

- The number of discs required to copy the files is displayed. Prepare the discs accordingly.

7 Tap “AUTO” or “BY DATE”. (👤 mode only)

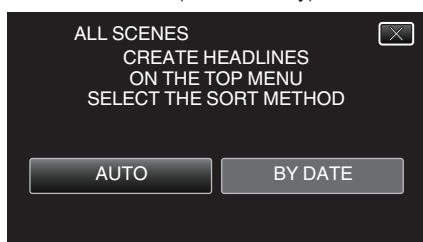

- When “AUTO” is selected, videos with similar recording dates are displayed in groups.
- When “BY DATE” is selected, videos are displayed according to recording dates.

8 Tap “EXECUTE”.

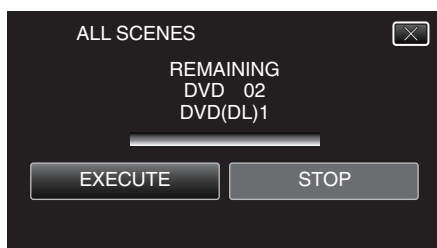

- When “INSERT THE NEXT DISC TO CREATE OR PRESS STOP TO EXIT” appears, change the disc.

9 Tap “OK” when “COMPLETED” is displayed.

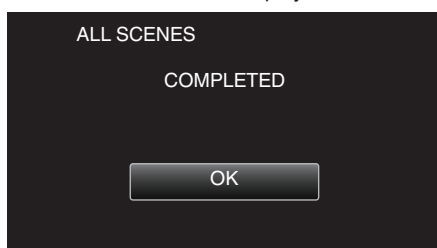

10 Turn off this unit and disconnect the USB cable.

**Caution :**

- Do not turn off the power or remove the USB cable until copying is complete.
- Files that are not on the index screen during playback cannot be copied. Special files cannot be copied either.
- All DVDs will be finalized automatically. While files cannot be added to the DVD-R/DVD-RW later, files can still be added to the BD-R/BD-RE.
- DVDs that are created in “DVD(AVCHD)” format are playable only on AVCHD compatible devices.
- Videos that are recorded in the 50p mode (when “SYSTEM SELECT” is set to “50p”) can only be copied to Blu-ray discs.
- Blu-ray discs containing videos that are recorded in the 50p mode (when “SYSTEM SELECT” is set to “50p”) are playable only on AVCHD Progressive compatible devices.

**Memo :**

- To check the created disc, refer to ““Playing Back with a BD Writer (External Blu-ray Drive)” (p. 77) ”.

“Playing Back with a BD Writer (External Blu-ray Drive)” (p. 77)

## Copying Files by Date

Videos or still images are sorted and copied according to the date on which they were recorded.

- 1 Select video or still image mode.
- 2 Tap "SELECT AND CREATE" (video) or "SELECT AND SAVE" (still image).

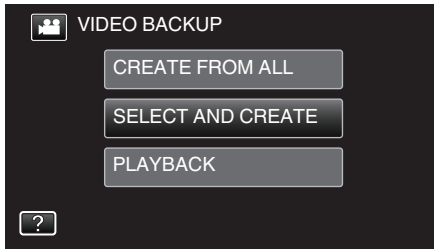

- While the video mode is shown in the image, the same operations apply for the still image mode.
- Tap to switch between the video (50i), video (50p), and still image modes. Switch to the mode in which you want to copy files.

- 3 Tap "Blu-ray DISC" or "DVD(AVCHD)".

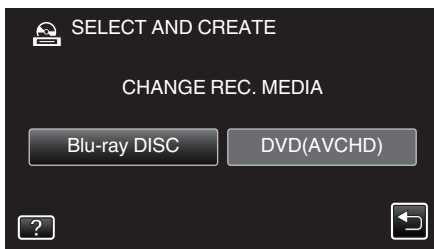

- The media changes to the tapped item. Select the appropriate setting according to the disc.
- Selecting "Blu-ray DISC" enables you to save videos in a Blu-ray disc in the high definition quality.
- Selecting "DVD(AVCHD)" enables you to save videos in a DVD in the high definition quality.
- If you have selected 50p videos in step 2, this screen will not appear because "Blu-ray DISC" is automatically selected.

- 4 Tap on the media to copy.

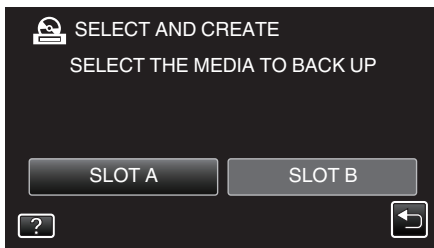

- 5 Tap "CREATE BY DATE" (video) or "SAVE BY DATE" (still image).

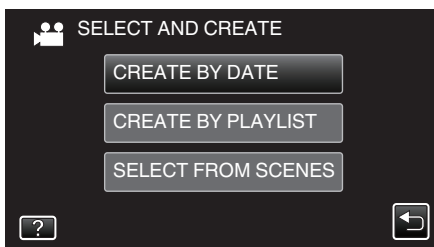

- While the video mode is shown in the image, the same operations apply for the still image mode.

- 6 Tap to select a recording date.

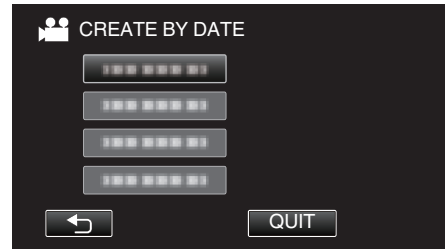

- If the desired date cannot be found, switch the mode to video (50i), video (50p), or still image accordingly in step 2.

### Memo :

- You cannot select more than one recording date for copying. To copy files from multiple recording dates, it is recommended to copy by creating a playlist.

"Creating Playlists from the Recorded Videos" (p. 63)

"Copying Selected Playlists" (p. 73)

- 7 Tap "EXECUTE".

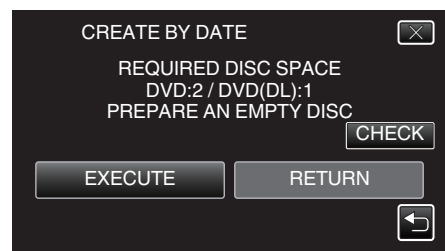

- The number of discs required to copy the files is displayed. Prepare the discs accordingly.

- 8 Tap "AUTO" or "BY DATE". (camera mode only)

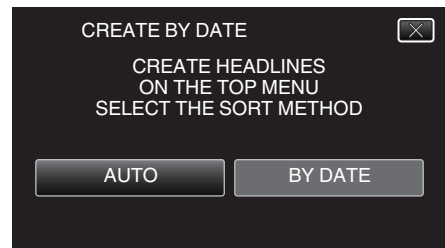

- When "AUTO" is selected, videos with similar recording dates are displayed in groups.
- When "BY DATE" is selected, videos are displayed according to recording dates.

- 9 Tap "EXECUTE".

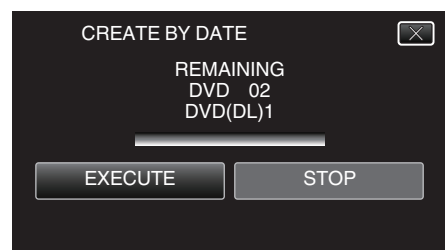

- When "INSERT THE NEXT DISC TO CREATE OR PRESS STOP TO EXIT" appears, change the disc.



10 Tap "OK" when "COMPLETED" is displayed.

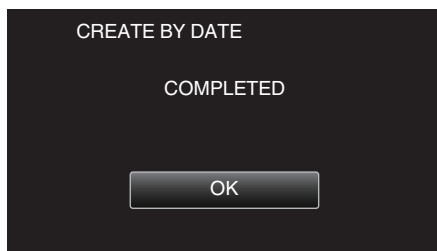

11 Turn off this unit and disconnect the USB cable.

**Caution :**

- Do not turn off the power or remove the USB cable until copying is complete.
- Files that are not on the index screen during playback cannot be copied. Special files cannot be copied either.
- All DVDs will be finalized automatically. While files cannot be added to the DVD-R/DVD-RW later, files can still be added to the BD-R/BD-RE.
- DVDs that are created in "DVD(AVCHD)" format are playable only on AVCHD compatible devices.
- Videos that are recorded in the 50p mode (when "SYSTEM SELECT" is set to "50p") can only be copied to Blu-ray discs.
- Blu-ray discs containing videos that are recorded in the 50p mode (when "SYSTEM SELECT" is set to "50p") are playable only on AVCHD Progressive compatible devices.

**Memo :**

- To check the created disc, refer to "Playing Back with a BD Writer (External Blu-ray Drive)" (p. 77).

"Playing Back with a BD Writer (External Blu-ray Drive)" (p. 77)

**Copying Selected Playlists**

Arrange and copy the created playlists in the order you like.

- 1 Select video mode.
- 2 Tap "SELECT AND CREATE".

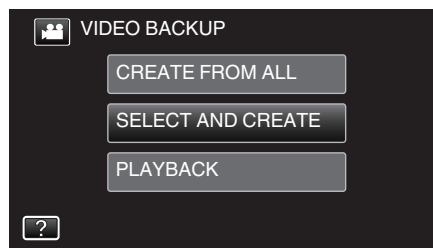

- Tap to switch between the video (50i), video (50p), and still image modes. Switch to the mode in which you want to copy files.

3 Tap "Blu-ray DISC" or "DVD(AVCHD)".

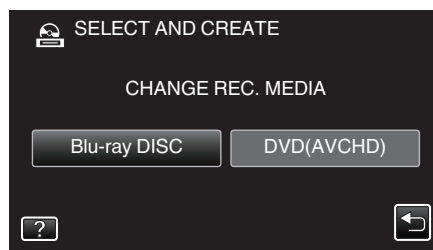

- The media changes to the tapped item. Select the appropriate setting according to the disc.
- Selecting "Blu-ray DISC" enables you to save videos in a Blu-ray disc in the high definition quality.
- Selecting "DVD(AVCHD)" enables you to save videos in a DVD in the high definition quality.

4 Tap on the media to copy.

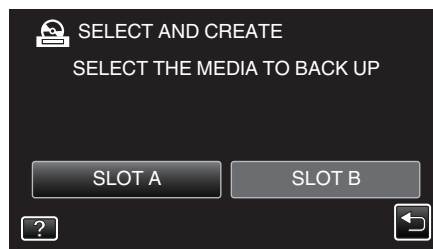

5 Tap "CREATE BY PLAYLIST".

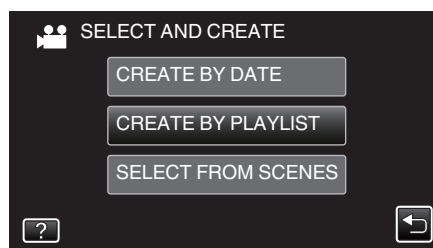

6 Tap on the playlist to copy to disc.

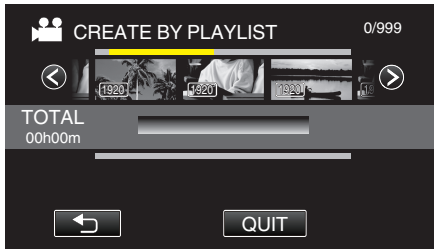

- ▶ appears on the selected playlist (upper row). Tap ↵ to deselect.
- Tap on the selected playlist again to check the content of the playlist. After checking, tap ↵.
- Tap </> or move the zoom lever to display the previous/next playlist.
- If the desired playlist cannot be found, switch the mode to video (50i) or video (50p) accordingly in step 2.

7 Tap "ADD" to insert a playlist.

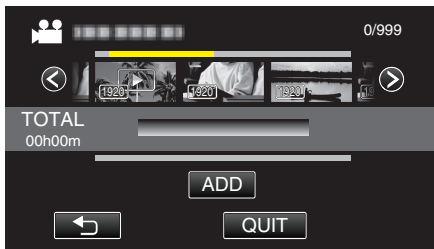

- Repeat steps 6-7 and arrange the playlists.
- To change the position of a playlist (lower row), select the insertion point with ←/→ after step 6 and tap "ADD".
- ▶ appears when the inserted playlist is selected. Tap ↵ to deselect.
- Tap on the selected playlist again to check the content of the playlist. After checking, tap ↵.
- To delete a video in the playlist (lower row), tap the video, then tap "CANCEL".

8 After arranging, tap "SAVE".

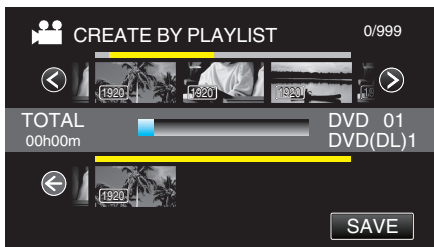

9 Tap "EXECUTE".

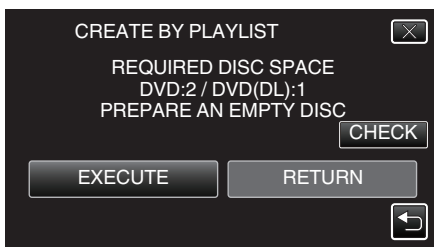

- The number of discs required to copy the files is displayed. Prepare the discs accordingly.
- Tap "CHECK" to check the content.

10 Tap "OK".

- If step 10 is not displayed, go to step 11.

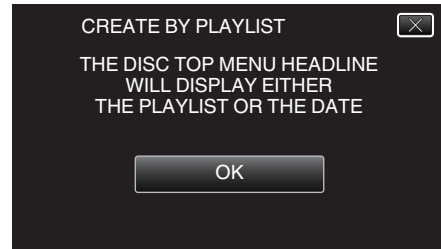

Alternatively, tap "AUTO" or "BY DATE".

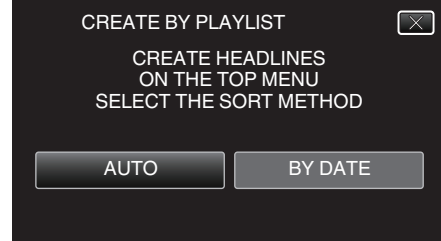

- When "AUTO" is selected, videos with similar recording dates are displayed in groups.
- When "BY DATE" is selected, videos are displayed according to recording dates.

11 Tap "EXECUTE".

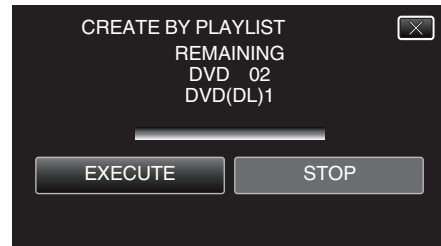

- When "INSERT THE NEXT DISC TO CREATE OR PRESS STOP TO EXIT" appears, change the disc.

12 Tap "OK" when "COMPLETED" is displayed.

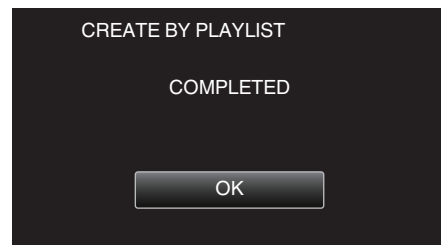

13 Turn off this unit and disconnect the USB cable.

**Caution :**

- Do not turn off the power or remove the USB cable until copying is complete.
- Files that are not on the index screen during playback cannot be copied. Special files cannot be copied either.
- All DVDs will be finalized automatically. While files cannot be added to the DVD-R/DVD-RW later, files can still be added to the BD-R/BD-RE.
- DVDs that are created in "DVD(AVCHD)" format are playable only on AVCHD compatible devices.
- Videos that are recorded in the 50p mode (when "SYSTEM SELECT" is set to "50p") can only be copied to Blu-ray discs.
- Blu-ray discs containing videos that are recorded in the 50p mode (when "SYSTEM SELECT" is set to "50p") are playable only on AVCHD Progressive compatible devices.

**Memo :**

- A list of playlists is displayed on the top menu of the created DVD.
- To check the created disc, refer to "Playing Back with a BD Writer (External Blu-ray Drive)" (p. 77).
- To create a playlist "Playing Back with a BD Writer (External Blu-ray Drive)" (p. 77)
- To create a playlist "Creating Playlists from the Recorded Videos" (p. 63)

**Copying Selected Files**

Select and copy the desired videos or still images individually.

- 1 Select video or still image mode.
- 2 Tap "SELECT AND CREATE" (video) or "SELECT AND SAVE" (still image).

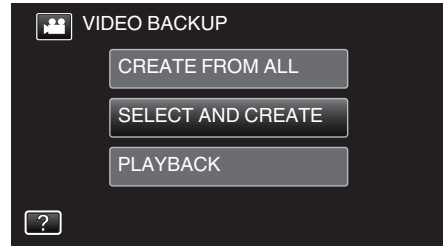

- While the video mode is shown in the image, the same operations apply for the still image mode.
- Tap the camera icon to switch between the video (50i), video (50p), and still image modes. Switch to the mode in which you want to copy files.

- 3 Tap "Blu-ray DISC" or "DVD(AVCHD)".

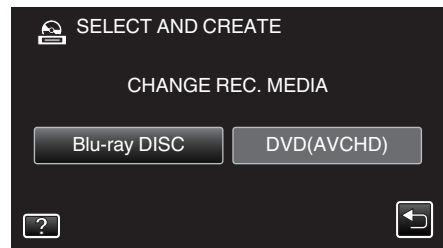

- The media changes to the tapped item. Select the appropriate setting according to the disc.
- Selecting "Blu-ray DISC" enables you to save videos in a Blu-ray disc in the high definition quality.
- Selecting "DVD(AVCHD)" enables you to save videos in a DVD in the high definition quality.

- 4 Tap on the media to copy.

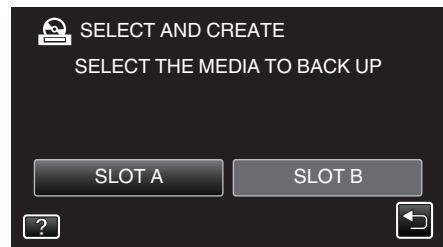

- 5 Tap "SELECT FROM SCENES" (video) or "SELECT FROM IMAGES" (still image).

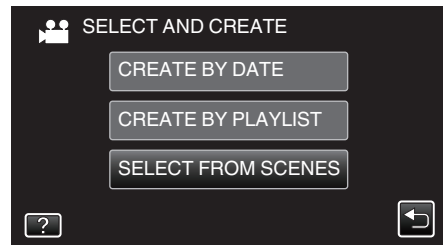

- While the video mode is shown in the image, the same operations apply for the still image mode.

6 Tap on the videos or still images to copy.

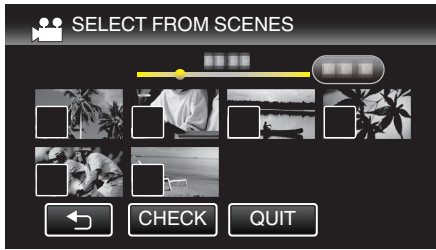

- ✓ appears on the selected files.  
To remove ✓ from a file, tap on the file again.
- Tap "CHECK" to check the file.
- If the desired video or still image cannot be found, switch the mode to video (50i), video (50p), or still image accordingly in step 2.

7 After selecting all the files, tap "SAVE".

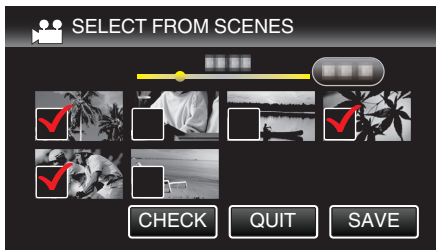

8 Tap "EXECUTE".



- The number of discs required to copy the files is displayed.  
Prepare the discs accordingly.

9 Tap "AUTO" or "BY DATE". (👤 mode only)

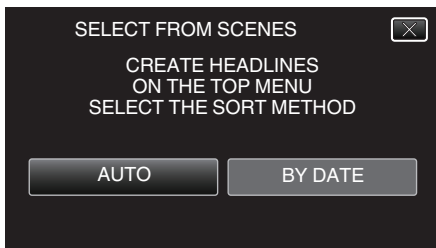

- When "AUTO" is selected, videos with similar recording dates are displayed in groups.
- When "BY DATE" is selected, videos are displayed according to recording dates.

10 Tap "EXECUTE".



- When "INSERT THE NEXT DISC TO CREATE OR PRESS STOP TO EXIT" appears, change the disc.

11 Tap "OK" when "COMPLETED" is displayed.

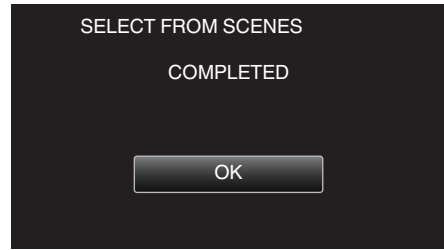

12 Turn off this unit and disconnect the USB cable.

**Caution :**

- Do not turn off the power or remove the USB cable until copying is complete.
- Files that are not on the index screen during playback cannot be copied. Special files cannot be copied either.
- All DVDs will be finalized automatically.  
While files cannot be added to the DVD-R/DVD-RW later, files can still be added to the BD-R/BD-RE.
- DVDs that are created in "DVD(AVCHD)" format are playable only on AVCHD compatible devices.
- Videos that are recorded in the 50p mode (when "SYSTEM SELECT" is set to "50p") can only be copied to Blu-ray discs.
- Blu-ray discs containing videos that are recorded in the 50p mode (when "SYSTEM SELECT" is set to "50p") are playable only on AVCHD Progressive compatible devices.

**Memo :**

- To check the created disc, refer to "Playing Back with a BD Writer (External Blu-ray Drive)" (📖 p. 77).

"Playing Back with a BD Writer (External Blu-ray Drive)" (📖 p. 77)

### Playing Back with a BD Writer (External Blu-ray Drive)

You can play back the Blu-ray discs created on this unit.

- 1 Connect this unit to a BD writer and a TV.  
(If this unit is not connected to a TV, images can be played back on the LCD monitor of this unit.)

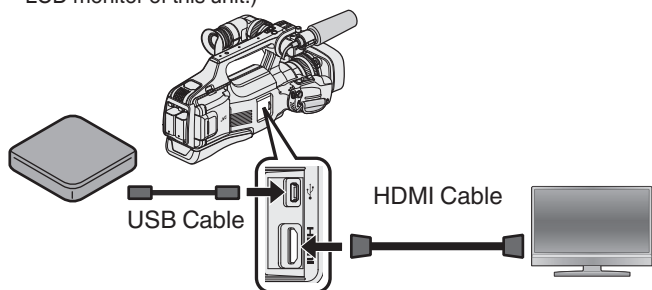

“Preparing a BD Writer (External Blu-ray Drive)” (p. 69)

“Connecting to and Viewing on TV” (p. 55)

- Insert the Blu-ray disc to play back into the BD writer (external Blu-ray drive).

- 2 Tap “PLAYBACK” in the BACK-UP menu.

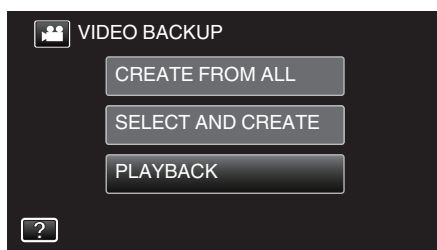

- An index screen (thumbnail display) of the videos in the disc appears.
- Tap to switch between the video (50i), video (50p), and still image modes. Switch to the mode in which you want to play back files.

- 3 Tap on the file to start playback.

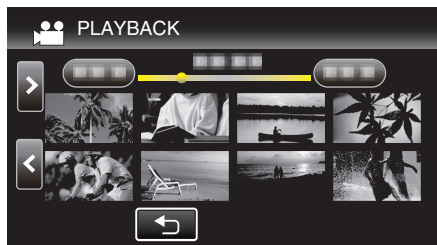

- For details on video playback, refer to ““Operation Buttons for Video Playback” (p. 45)”.

“Operation Buttons for Video Playback” (p. 45)

- To exit, stop playback and turn off this unit. Then, disconnect the USB cable.

**Memo :**

- To play back the recorded image on TV, connect this unit via the HDMI cable or the AV cable while this unit is connected to the BD writer (external Blu-ray drives).

“Connecting via the HDMI Connector” (p. 55)

“Connecting via the AV Connector” (p. 57)

### Creating Discs with a DVD Writer

You can copy the recorded files to discs or play back the created discs using an optional DVD writer.

#### Compatible DVD Writers

Product Name	Description
DVD Writer • CU-VD3U	• Enables the images recorded on this unit to be copied to a DVD without using a PC.
DVD Writer • CU-VD50U	• Creates DVDs and functions as an external DVD drive when connected to a PC. In addition, created DVDs can be played back by connecting the CU-VD50U to a TV.

### Creating Discs with a DVD Writer

#### ■ Preparing a DVD Writer

“Preparing a DVD Writer (CU-VD3)” (p. 78)

“Preparing a DVD Writer (CU-VD50)” (p. 78)

#### ■ Copying to Discs

“Copying All Files” (p. 79)

“Copying Files by Date” (p. 80)

“Copying Selected Playlists” (p. 81)

“Copying Selected Files” (p. 82)

#### ■ Other Operations

“Playing Back with a DVD Writer” (p. 83)

**Memo :**

- Discs created on this unit are saved in the AVCHD format. Play back on an AVCHD compatible device (such as Blu-ray recorder). In addition, discs in DVD-Video format cannot be created.
- Images recorded in UXP mode cannot be copied to a DVD writer.
- 50i videos, 50p videos and still images cannot be saved together on a disc.
- When there are many files to back up, it may take time for the backup to be completed. Wait for a while as the access lamp appears blinking, which indicates normal operation.
- Date and time information as saved as subtitles in the created discs.

**Preparing a DVD Writer (CU-VD3)**

- 1 Remove the AC adapter and battery pack from this unit.
- 2 Connect the USB cable and the AC adapter.

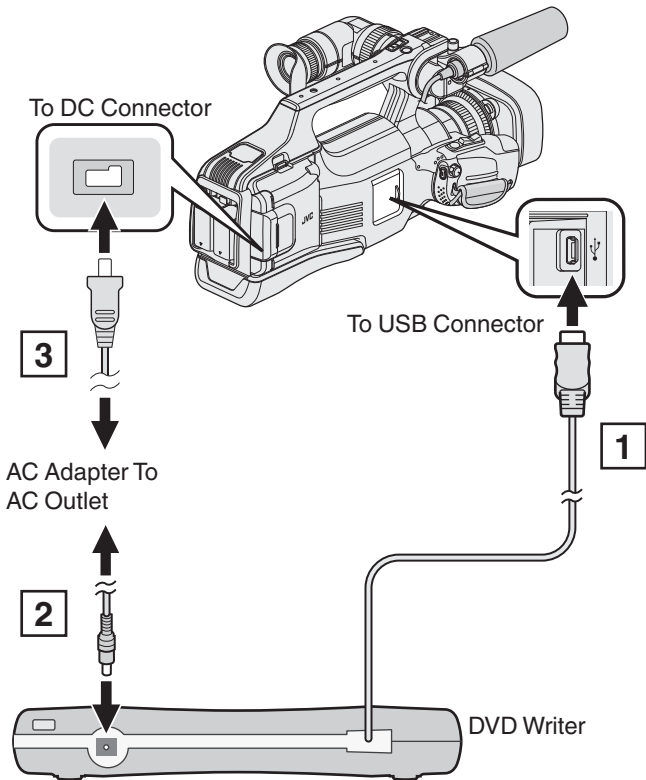

- 1 Connect the USB cable of the DVD writer to this unit.
- 2 Connect the AC adapter of the DVD writer.
- Turn on the DVD writer.
- 3 Connect the AC adapter to this unit.
  - Refer also to the instruction manual of the DVD writer.
- 3 Set the "STANDBY/ON OFF" switch to "ON".

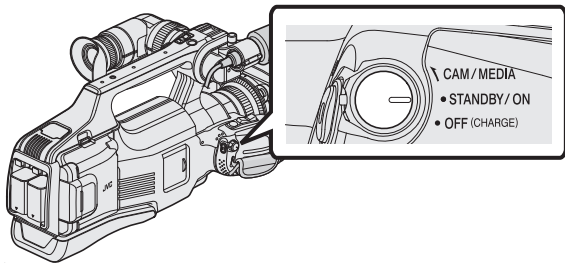

- When this unit is turned on, the "BACK-UP" menu appears.
- While the USB cable is connected, the "BACK-UP" menu is displayed.

- 4 Insert a new disc.

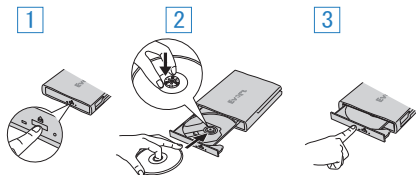

- 1 Press the eject button to open the disc tray.
- 2 Pull out the tray completely and load a new disc properly.
- 3 Push the disc tray in until it clicks into place.

**Caution :**

- Be sure to turn off the power when connecting the devices. Otherwise, electric shocks or malfunctions may occur.

**Preparing a DVD Writer (CU-VD50)**

- 1 Remove the AC adapter and battery pack from this unit.
- 2 Connect the USB cable and the AC adapter.

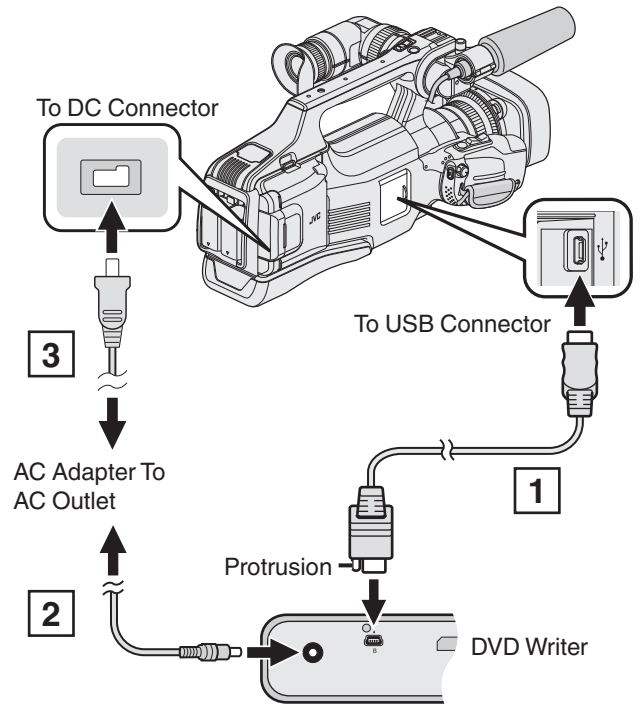

- 1 Connect the USB cable provided with the DVD writer.
- 2 Connect the AC adapter of the DVD writer.
- Turn on the DVD writer.
- 3 Connect the AC adapter to this unit.
  - Refer also to the instruction manual of the DVD writer.
- 3 Set the "STANDBY/ON OFF" switch to "ON".

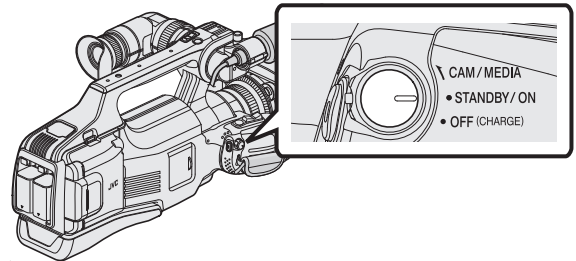

- When this unit is turned on, the "BACK-UP" menu appears.
- While the USB cable is connected, the "BACK-UP" menu is displayed.

- 4 Insert a new disc.

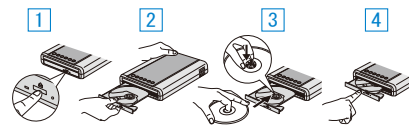

- 1 Press the eject button.
- 2 Pull out the disc tray.
- 3 Pull out the tray completely and load a new disc properly.
- 4 Push the disc tray in until it clicks into place.

**Caution :**

- Be sure to turn off the power when connecting the devices. Otherwise, electric shocks or malfunctions may occur.

**Memo :**

- All buttons on the DVD writer CU-VD50U, other than the power and eject buttons, will not work when connected to this unit.

## Creating a Disc

- 1 Prepare a DVD writer.
  - Insert a new disc into the DVD writer.
  - “Preparing a DVD Writer (CU-VD3)” (p. 78)
  - “Preparing a DVD Writer (CU-VD50)” (p. 78)
- 2 Copy files to the disc with the following methods.
  - “Copying All Files” (p. 79)
  - “Copying Files by Date” (p. 80)
  - “Copying Selected Playlists” (p. 81)
  - “Copying Selected Files” (p. 82)

## Copying All Files

All videos or still images recorded on this unit will be copied. You can also select and copy only the videos or still images that have never been copied.

- 1 Select video or still image mode.
- 2 Tap “CREATE FROM ALL” (video) or “SAVE ALL” (still image).

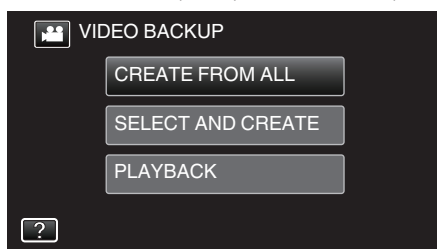

- While the video mode is shown in the image, the same operations apply for the still image mode.
- Tap to switch between the video and still image modes.

- 3 Tap on the media to copy.

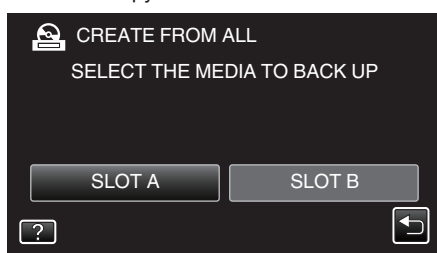

- 4 Tap the desired method.

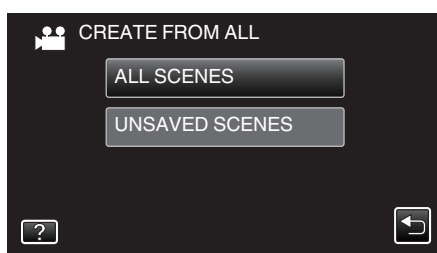

- While the video mode is shown in the image, the same operations apply for the still image mode.
- **“ALL SCENES” (video)/“ALL IMAGES” (still image):**  
All videos or still images in this unit are copied.
- **“UNSAVED SCENES” (video)/“UNSAVED IMAGES” (still image):**  
Videos or still images that have never been copied are automatically selected and copied.

- 5 Tap “EXECUTE”.

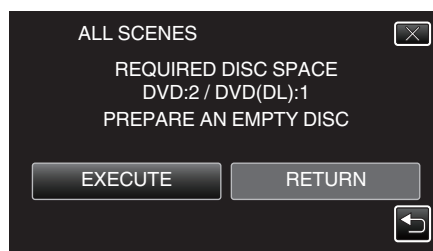

- The number of discs required to copy the files is displayed. Prepare the discs accordingly.

- 6 Tap “AUTO” or “BY DATE”. ( mode only)

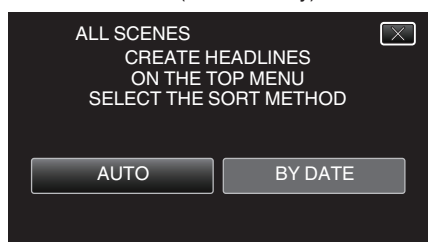

- When “AUTO” is selected, videos with similar recording dates are displayed in groups.
- When “BY DATE” is selected, videos are displayed according to recording dates.

- 7 Tap “EXECUTE”.

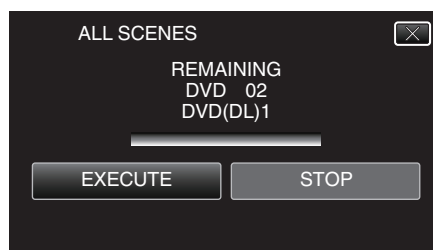

- When “INSERT THE NEXT DISC TO CREATE OR PRESS STOP TO EXIT” appears, change the disc.

- 8 Tap “OK” when “COMPLETED” is displayed.

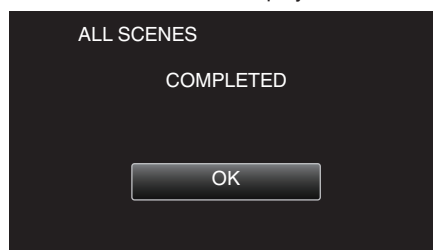

- 9 Turn off this unit and disconnect the USB cable.

### Caution :

- Do not turn off the power or remove the USB cable until copying is complete.
- Files that are not on the index screen during playback cannot be copied. Special files cannot be copied either.
- All DVDs will be finalized automatically. Files cannot be added to the DVD-R/DVD-RW later.

### Memo :

- To check the created disc, refer to ““Playing Back with a DVD Writer” (p. 83) ”.

“Playing Back with a DVD Writer” (p. 83)

## Copying Files by Date

Videos or still images are sorted and copied according to the date on which they were recorded.

- 1 Select video or still image mode.
- 2 Tap "SELECT AND CREATE" (video) or "SELECT AND SAVE" (still image).

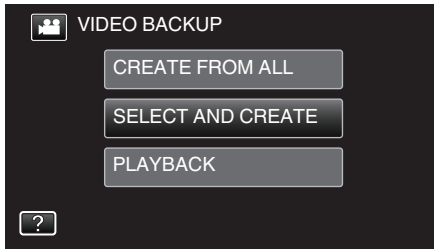

- While the video mode is shown in the image, the same operations apply for the still image mode.
- Tap to switch between the video and still image modes.

- 3 Tap on the media to copy.

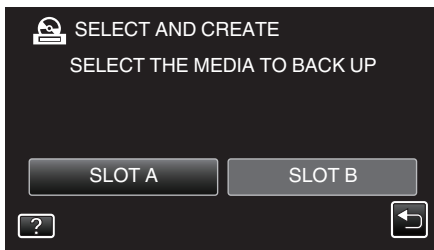

- 4 Tap "CREATE BY DATE" (video) or "SAVE BY DATE" (still image).

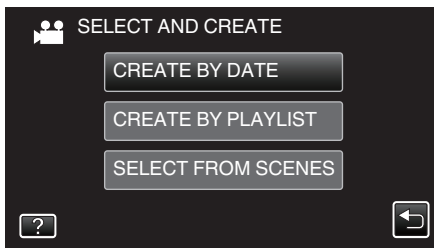

- While the video mode is shown in the image, the same operations apply for the still image mode.

- 5 Tap to select a recording date.



- You cannot select more than one recording date for copying. To copy files from multiple recording dates, it is recommended to copy by creating a playlist.

"Creating Playlists from the Recorded Videos" (p. 63)  
 "Copying Selected Playlists" (p. 81)

- 6 Tap "EXECUTE".



- The number of discs required to copy the files is displayed. Prepare the discs accordingly.
- Tap "CHECK" to check the content.

- 7 Tap "AUTO" or "BY DATE". (mode only)

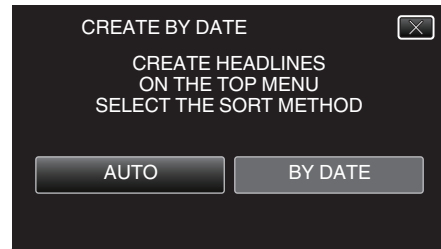

- When "AUTO" is selected, videos with similar recording dates are displayed in groups.
- When "BY DATE" is selected, videos are displayed according to recording dates.

- 8 Tap "EXECUTE".

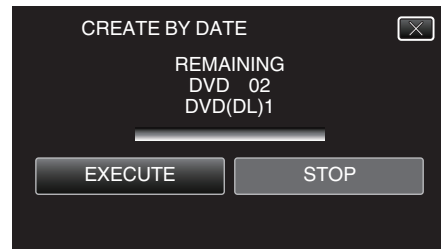

- When "INSERT THE NEXT DISC TO CREATE OR PRESS STOP TO EXIT" appears, change the disc.

- 9 Tap "OK" when "COMPLETED" is displayed.

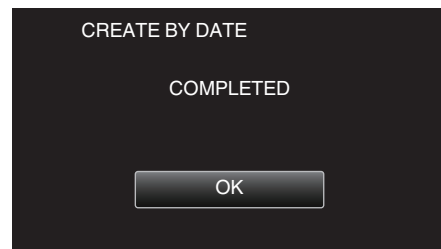

- 10 Turn off this unit and disconnect the USB cable.

### Caution :

- Do not turn off the power or remove the USB cable until copying is complete.
- Files that are not on the index screen during playback cannot be copied. Special files cannot be copied either.
- All DVDs will be finalized automatically. Files cannot be added to the DVD-R/DVD-RW later.

### Memo :

- To check the created disc, refer to "Playing Back with a DVD Writer" (p. 83).

"Playing Back with a DVD Writer" (p. 83)



### Copying Selected Playlists

Arrange and copy the created playlists in the order you like.

- 1 Select video mode.
- 2 Tap "SELECT AND CREATE".

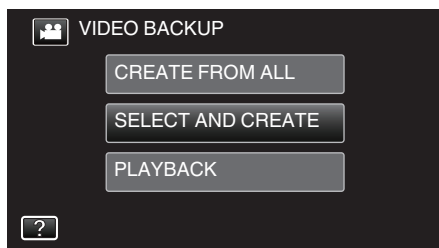

- 3 Tap on the media to copy.

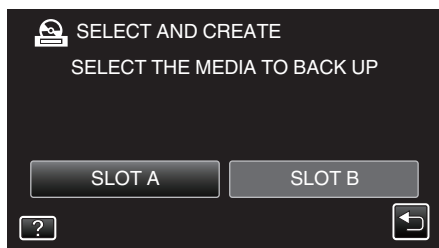

- 4 Tap "CREATE BY PLAYLIST".

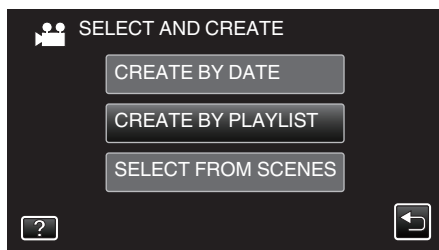

- 5 Tap on the playlist to copy to disc.



- ▶ appears on the selected playlist (upper row). Tap ↵ to deselect.
- Tap on the selected playlist again to check the content of the playlist. After checking, tap ↵.
- Tap </> or move the zoom lever to display the previous/next playlist.

- 6 Tap "ADD" to insert a playlist.



- Repeat steps 5-6 and arrange the playlists.
- To change the position of a playlist (lower row), select the insertion point with ←/→ after step 5 and tap "ADD".
- ▶ appears when the inserted playlist is selected. Tap ↵ to deselect.
- Tap on the selected playlist again to check the content of the playlist. After checking, tap ↵.
- To delete of a video in the playlist (lower row), tap the video, then tap "CANCEL".

- 7 After arranging, tap "SAVE".

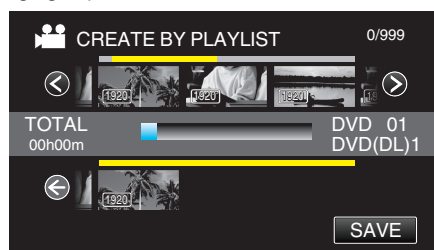

- 8 Tap "EXECUTE".

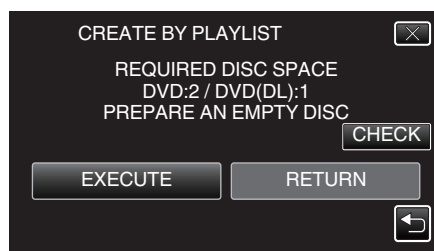

- The number of discs required to copy the files is displayed. Prepare the discs accordingly.
- Tap "CHECK" to check the content. After checking, tap ↵.

- 9 Tap "OK".

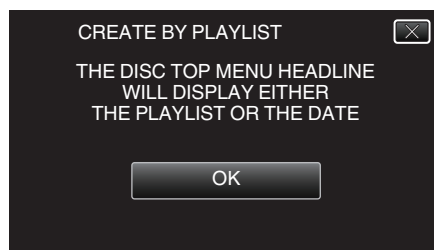

10 Tap "EXECUTE".

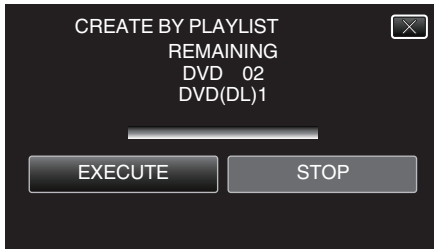

- When "INSERT THE NEXT DISC TO CREATE OR PRESS STOP TO EXIT" appears, change the disc.

11 Tap "OK" when "COMPLETED" is displayed.

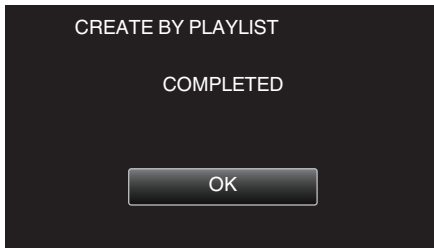

12 Turn off this unit and disconnect the USB cable.

### Caution :

- Do not turn off the power or remove the USB cable until copying is complete.
- Files that are not on the index screen during playback cannot be copied. Special files cannot be copied either.
- All DVDs will be finalized automatically. Files cannot be added to the DVD-R/DVD-RW later.

### Memo :

- A list of playlists is displayed on the top menu of the created DVD.
- To check the created disc, refer to "Playing Back with a DVD Writer" (p. 83).

"Playing Back with a DVD Writer" (p. 83)

- To create a playlist
- "Creating Playlists from the Recorded Videos" (p. 63)

## Copying Selected Files

Select and copy the desired videos or still images individually.

- 1 Select video or still image mode.
- 2 Tap "SELECT AND CREATE" (video) or "SELECT AND SAVE" (still image).

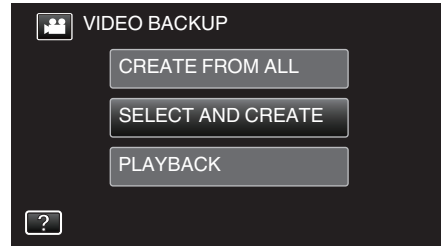

- While the video mode is shown in the image, the same operations apply for the still image mode.
- Tap to switch between the video and still image modes.

3 Tap on the media to copy.

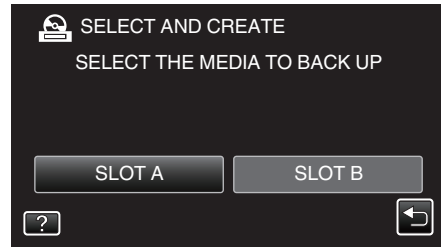

4 Tap "SELECT FROM SCENES" (video) or "SELECT FROM IMAGES" (still image).

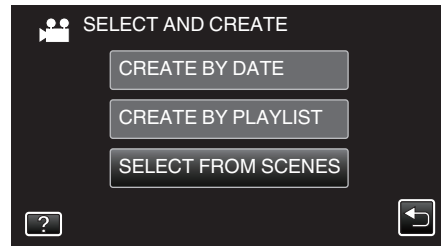

- While the video mode is shown in the image, the same operations apply for the still image mode.

5 Tap on the videos or still images to copy.

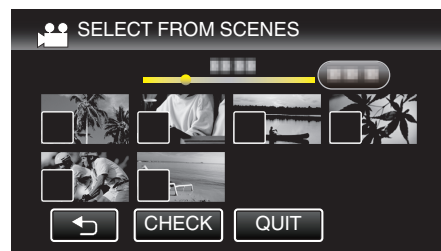

- ✓ appears on the selected files. To remove ✓ from a file, tap on the file again.
- Tap "CHECK" to check the file.
- While the video mode is shown in the image, the same operations apply for the still image mode.

6 After selecting all the files, tap "SAVE".

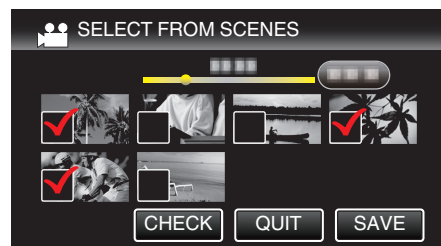

- While the video mode is shown in the image, the same operations apply for the still image mode.

7 Tap "EXECUTE".

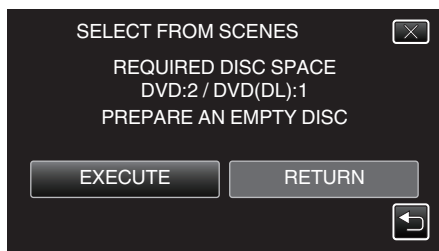

- The number of discs required to copy the files is displayed. Prepare the discs accordingly.

8 Tap "AUTO" or "BY DATE". (👤 mode only)

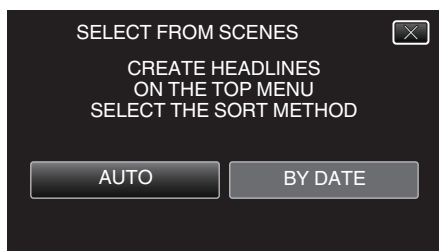

- When "AUTO" is selected, videos with similar recording dates are displayed in groups.
- When "BY DATE" is selected, videos are displayed according to recording dates.

9 Tap "EXECUTE".



- When "INSERT THE NEXT DISC TO CREATE OR PRESS STOP TO EXIT" appears, change the disc.

10 Tap "OK" when "COMPLETED" is displayed.

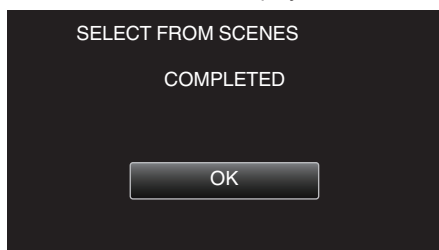

11 Turn off this unit and disconnect the USB cable.

**Caution :**

- Do not turn off the power or remove the USB cable until copying is complete.
- Files that are not on the index screen during playback cannot be copied. Special files cannot be copied either.
- All DVDs will be finalized automatically. Files cannot be added to the DVD-R/DVD-RW later.

**Memo :**

- To check the created disc, refer to "Playing Back with a DVD Writer" (p. 83).

"Playing Back with a DVD Writer" (p. 83)

**Playing Back with a DVD Writer**

You can play back the DVDs created on this unit.

- 1 Connect this unit to the DVD writer and TV. (If this unit is not connected to a TV, images can be played back on the LCD monitor of this unit.)

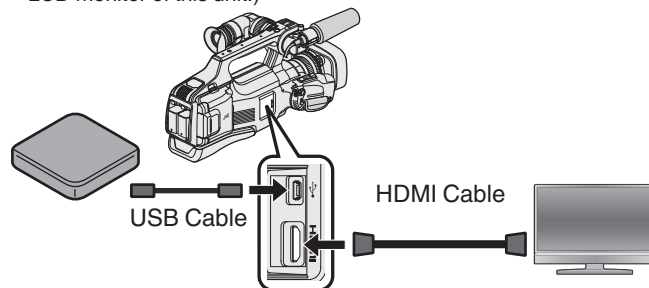

- "Preparing a DVD Writer (CU-VD3)" (p. 78)
- "Preparing a DVD Writer (CU-VD50)" (p. 78)
- "Connecting to and Viewing on TV" (p. 55)

- Insert the DVD to play back into the DVD writer.

2 Tap "PLAYBACK" in the BACK-UP menu.

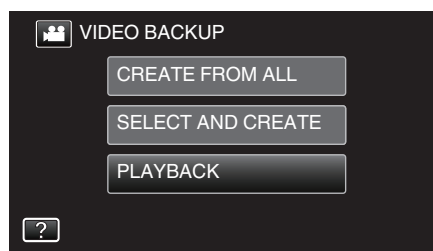

- An index screen (thumbnail display) of the videos in the disc appears.

3 Tap on the file to start playback.



- Tap "⏪" to return to the "BACK-UP" menu.
- For details on video playback, refer to "Operation Buttons for Video Playback" (p. 45).
- "Operation Buttons for Video Playback" (p. 45)
- To exit, stop playback and turn off this unit. Then, disconnect the USB cable.

**Memo :**

- To play back the recorded image on TV, connect this unit via the HDMI cable or the AV cable while this unit is connected to the DVD writer.
- "Connecting via the HDMI Connector" (p. 55)
- "Connecting via the AV Connector" (p. 57)

## Creating a Disc Using a Connected Blu-ray Recorder

You can create discs using a Blu-ray recorder by connecting it to this unit using a USB cable.

- 1 Remove the AC adapter and battery pack from this unit.
- 2 Connect to a Blu-ray recorder.

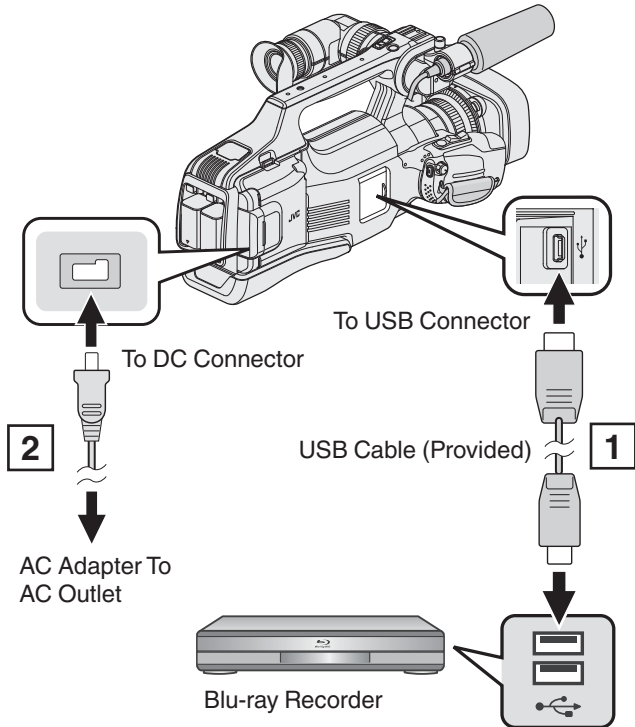

- 1 Connect using the provided USB cable.
- 2 Connect the AC adapter to this unit.

- 3 Set the "STANDBY/ON OFF" switch to "ON".

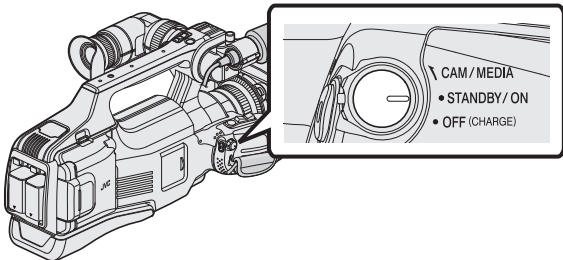

- When this unit is turned on, the "SELECT DEVICE" screen appears.

- 4 Tap "CONNECT TO OTHER".

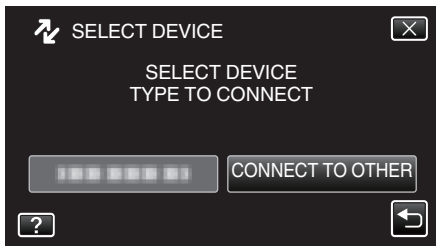

- 5 Tap the desired media.

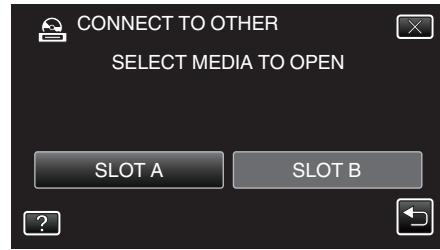

- The following screen is displayed after the camera operation is completed.



- Operations are to be performed on the Blu-ray recorder after the screen switches.

- 6 Perform dubbing on the Blu-ray recorder.

- Refer also to the instruction manual of the Blu-ray recorder.
- After dubbing is complete, disconnect the USB cable. Operations cannot be performed on this unit until the USB cable is disconnected.

**Memo :**

- To copy videos that are recorded in the 50p mode (when "SYSTEM SELECT" is set to "50p"), use an AVCHD Progressive compatible Blu-ray recorder.
- Videos that are recorded in the 50p mode (when "SYSTEM SELECT" is set to "50p") can only be copied to Blu-ray discs.

## Dubbing Files to a Disc by Connecting to a DVD Recorder

You can dub videos in standard quality by connecting to a DVD recorder.

- Refer also to the instruction manuals of the TV and DVD recorder.

- 1 Remove the AC adapter and battery pack from this unit.
- 2 Connect to a DVD recorder.

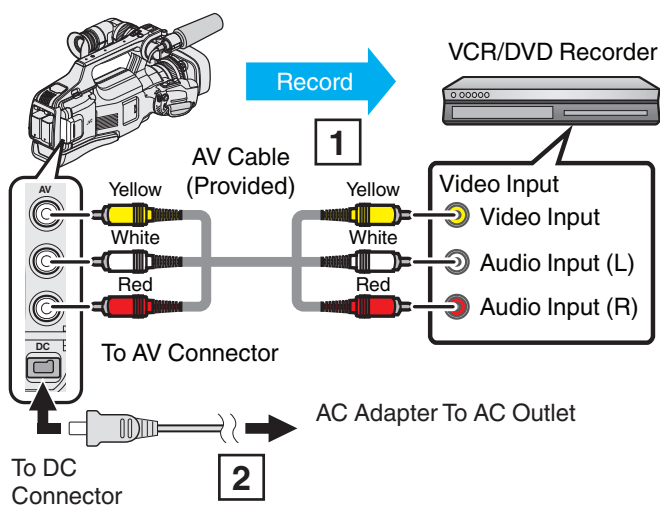

- 1 Connect using the provided AV cable.
- 2 Connect the AC adapter to this unit.

- 3 Set the "STANDBY/ON OFF" switch to "ON".

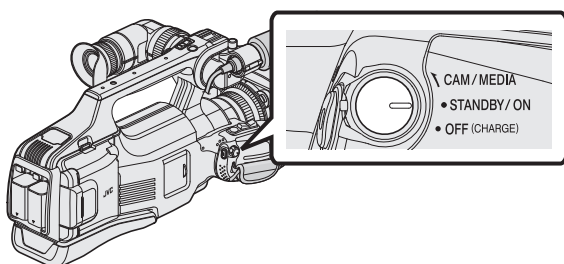

- 4 Tap <<MEDIA to select the playback mode.

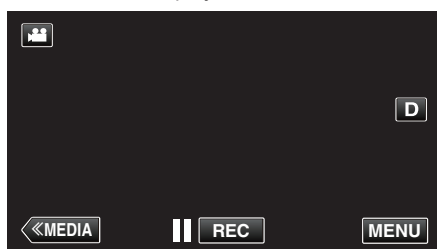

- 5 Prepare the TV/DVD recorder for recording.
  - Switch to a compatible external input.
  - Insert a disc (DVD-R, etc.) into the DVD recorder.
- 6 Prepare this unit for playback.
  - Set "VIDEO OUTPUT" in the "CONNECTION SETTINGS" menu to the aspect ratio ("4:3" or "16:9") of the connecting TV.

"VIDEO OUTPUT" (p. 108)
- 7 Start recording.
  - Start playback on this unit and press the record button on the recorder.

"Playing Back Videos" (p. 45)

  - After playback is complete, stop the recording.

**Memo :** \_\_\_\_\_

- When there are many videos to dub, you can create a playlist in advance and play it back so that all your favorite videos can be dubbed at once.
  - "Creating Playlists with Selected Files" (p. 63)
  - "PLAYBACK PLAYLIST" (p. 50)
- To include the recording date and time during dubbing, set "DISPLAY DATE/TIME" in the "PLAYBACK SETTING" menu to "ON". Or, set "DISPLAY ON TV" in the "CONNECTION SETTINGS" menu to "ON".

## Dubbing Files to a VHS Tape by Connecting to a VCR

You can dub videos in standard quality by connecting to a VCR.

- Refer also to the instruction manuals of the TV and VCR.

- 1 Remove the AC adapter and battery pack from this unit.
- 2 Connect to a VCR/DVD recorder.

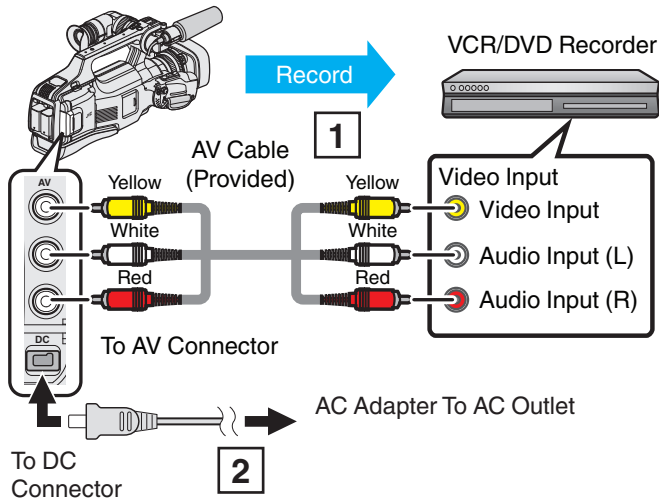

- 1 Connect using the provided AV cable.
- 2 Connect the AC adapter to this unit.

- 3 Set the "STANDBY/ON OFF" switch to "ON".

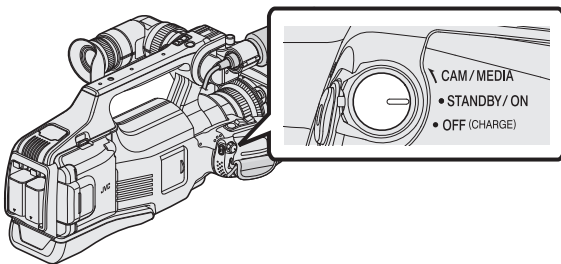

- 4 Tap <<MEDIA to select the playback mode.

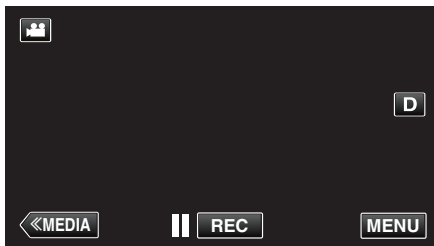

- 5 Prepare the TV/VCR for recording.
  - Switch to a compatible external input.
  - Insert a video tape.
- 6 Prepare this unit for playback.
  - Set "VIDEO OUTPUT" in the "CONNECTION SETTINGS" menu to the aspect ratio ("4:3" or "16:9") of the connecting TV.
  - "VIDEO OUTPUT" (p. 108)
- 7 Start recording.
  - Start playback on this unit and press the record button on the recorder.
  - "Playing Back Videos" (p. 45)
  - After playback is complete, stop the recording.

### Memo :

- When there are many videos to dub, you can create a playlist in advance and play it back so that all your favorite videos can be dubbed at once.
  - "Creating Playlists with Selected Files" (p. 63)
  - "PLAYBACK PLAYLIST" (p. 50)
- To include the recording date and time during dubbing, set "DISPLAY DATE/TIME" in the "PLAYBACK SETTING" menu to "ON". Or, set "DISPLAY ON TV" in the "CONNECTION SETTINGS" menu to "ON".

## Using a USB External Hard Disk Drive

You can copy video and still image files to a USB external hard disk drive from this unit. You can also play the files in the USB external hard disk drive on this unit.

- Refer also to the instruction manual of the external hard disk drive.

### Compatible External Hard Disk Drives

You can use the “LaCie Hard Disk Sleek black design USB2.0” series from LaCie.

**Memo :** \_\_\_\_\_

Before purchasing, check the compatible devices on the LaCie website.

- LaCie

<http://www.lacie.com/home.htm?cc=1>

- USB external hard disk drives up to 2 TB can be used.

### Copying and Playback with a USB External Hard Disk Drive

“Preparing a USB External Hard Disk Drive” (p. 87)

“Copying All Files” (p. 88)

“Playing Back Files in the USB External Hard Disk Drive” (p. 90)

“Deleting Folders in the USB External Hard Disk Drive” (p. 90)

**Memo :** \_\_\_\_\_

- Format the USB external hard disk drive when connecting it to this unit for the first time. (All data will be deleted.)

“Formatting the USB External Hard Disk Drive” (p. 91)

- USB external hard disk drives with the capacity over 2 TB cannot be used.
- Copying may take time. (For example, saving 1 hour video in XP mode takes about 20 minutes.)
- When there are many files to back up, it may take time for the backup to be completed. Wait for a while as the access lamp appears blinking, which indicates normal operation.
- Sound or video may be interrupted during playback.

**Caution :** \_\_\_\_\_

- Do not connect a USB hub between this unit and the USB external hard disk drive.
- Disconnect the USB external hard disk drive when using other USB devices such as DVD writer, BD writer (external Blu-ray drive), or another USB external hard disk drive.
- Avoid the following operations during copying and playing back.
  - Turning off the unit or the USB external hard disk drive.
  - Disconnecting the USB cable.
- Do not format the USB external hard disk drive using the PC. If you did, format again using this unit. (All the data in the USB external hard disk drive will be erased.)
- Avoid the following operations using the PC.
  - Deleting files or folders in the USB external hard disk drive.
  - Moving files or folders in the USB external hard disk drive.
  - Changing the name of files or folders in the USB external hard disk drive.
 These operations make the data impossible to be played back on this unit.
- When you use the PC to edit the data in the USB external hard disk drive, copy the data to the PC before editing. Editing the data in the USB external hard disk drive directly from the PC makes the data impossible to be played back on this unit.

### Preparing a USB External Hard Disk Drive

**Memo :** \_\_\_\_\_

- When connecting to the external hard disk drive, use a USB cable with Mini-A (Male) – B (Male) connectors. The USB cable provided with this unit cannot be used.
- To use the USB cable provided with the USB external hard disk drive, purchase the following USB conversion cable. Part number: QAM0852-001 \* Mini-A (Male) – A (Female) \*Consult your nearest service center.

- 1 Remove the AC adapter and battery pack from this unit.
- 2 Connect the USB cable and the AC adapter.

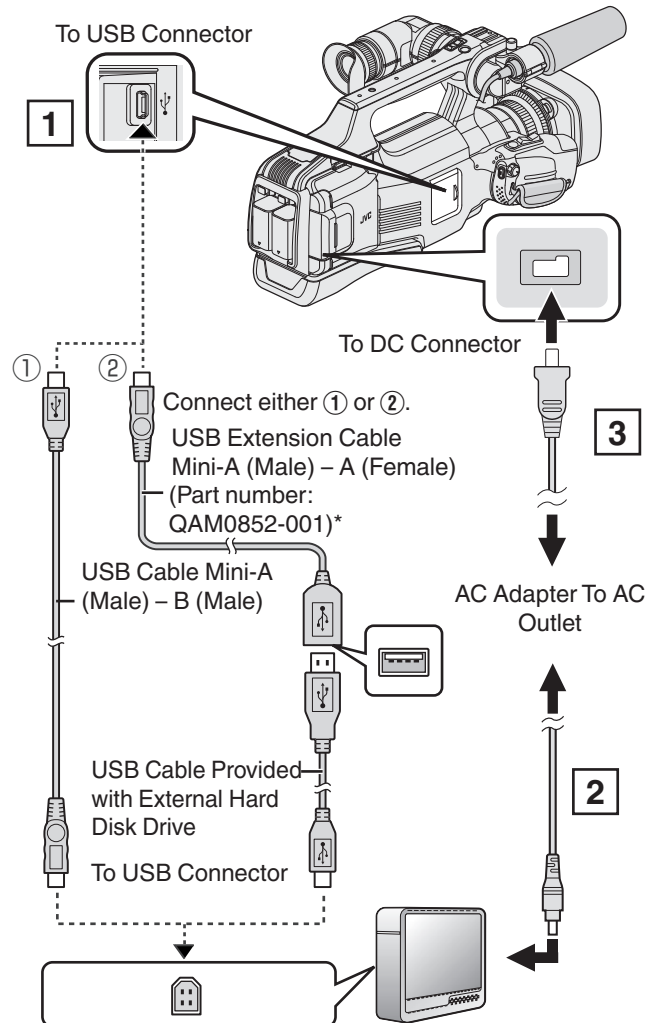

\* Consult your nearest service center.

- 1 Connect the USB cable with the USB external hard disk drive.
  - 2 Connect the AC adapter of the USB external hard disk drive.
  - 3 Connect the AC adapter to this unit.
- Turn on the external hard disk drive.
  - Refer also to the instruction manual of the external hard disk drive.

3 Set the "STANDBY/ON OFF" switch to "ON".

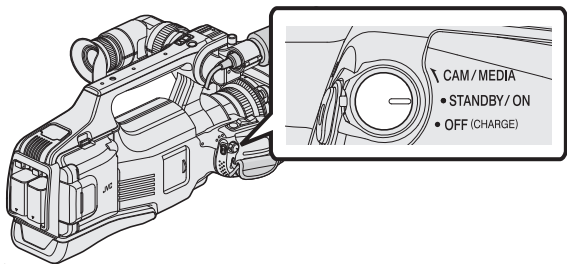

- When this unit is turned on, the "BACK-UP" menu appears.
- While the USB cable is connected, the "BACK-UP" menu is displayed.

**Caution :**

- Be sure to turn off the power when connecting the devices. Otherwise, electric shocks or malfunctions may occur.
- Do not connect a USB hub between this unit and the USB external hard disk drive.

### Copying All Files

All videos or still images recorded on this unit will be copied. You can also select and copy only the videos or still images that have never been copied.

- 1 Select video or still image mode.
- 2 Tap "BACK UP".

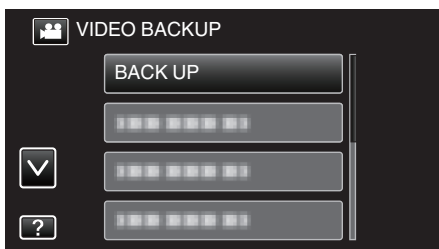

- While the video mode is shown in the image, the same operations apply for the still image mode.
- Tap the video/still image icon to switch between the video (50i), video (50p), and still image modes. Switch to the mode in which you want to copy files.

3 Tap on the media to copy.

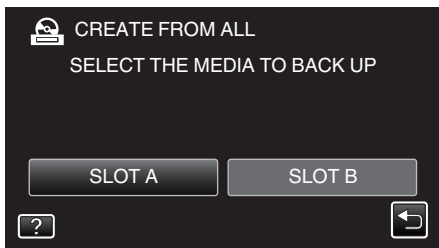

4 Tap the desired method.

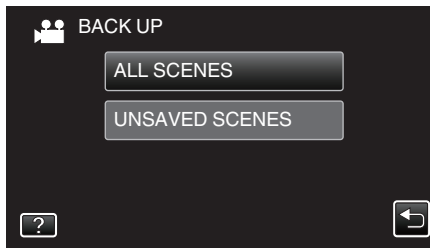

- **"ALL SCENES" (video)/"ALL IMAGES" (still image):**  
All videos or still images in this unit are copied.
- **"UNSAVED SCENES" (video)/"UNSAVED IMAGES" (still image):**

Videos or still images that have never been copied are automatically selected and copied.

5 Check that there is sufficient remaining space on the hard disk drive and tap "YES".

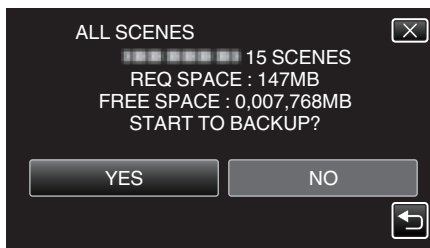

- Backup starts when "YES" is tapped.

6 Tap "OK" when "COMPLETED" is displayed.

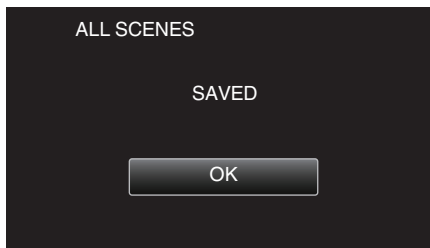

7 Turn off this unit and disconnect the USB cable.

**Caution :**

- Do not turn off the power or remove the USB cable until copying is complete.
- Files that are not on the index screen during playback cannot be copied. Special files cannot be copied either.
- If the desired video or still image is not copied, switch the mode to video (50i), video (50p), or still image accordingly in step 2.
- Copying may take time. (For example, saving 1 hour video in XP mode takes about 20 minutes.)



**Folder Structure on an External Hard Disk Drive**

Folders and files are created in the external hard disk drive as shown below. They are created only when necessary.

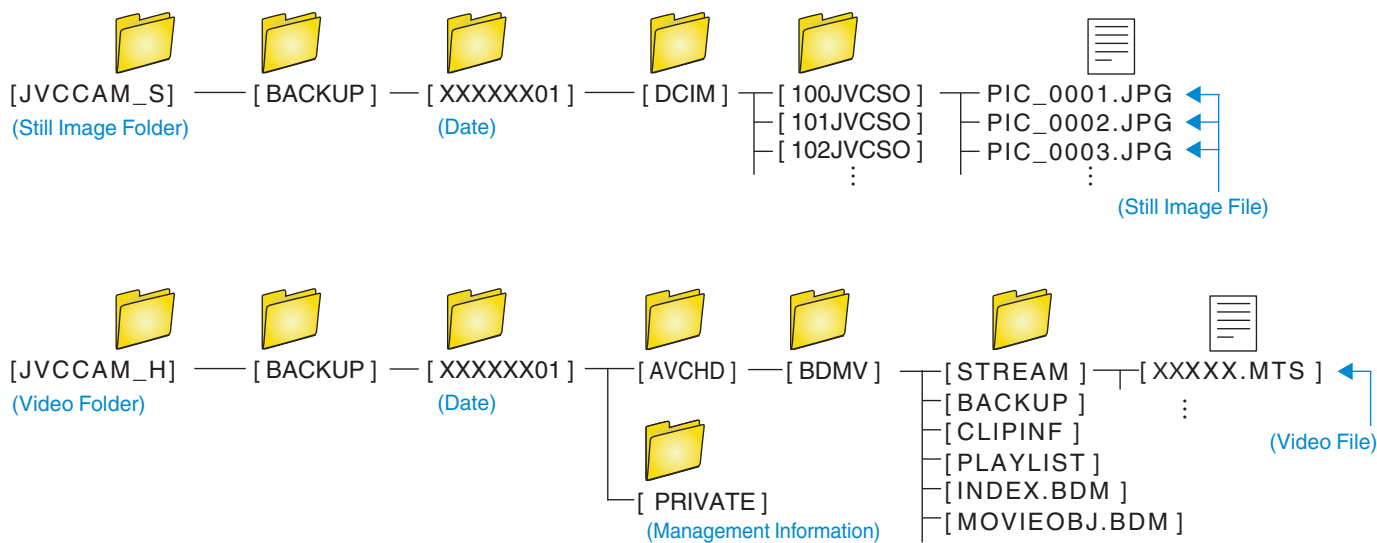

**Memo :**

- Videos recorded in the progressive format (50p) will be saved in [JVCCAM\_X].

## Copying

### Playing Back Files in the USB External Hard Disk Drive

Videos or still images saved in an external hard disk drive can be played back on this unit.

- 1 Tap "PLAYBACK".

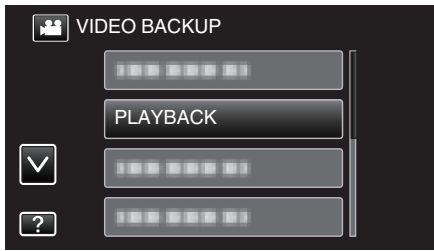

- 2 Select video (50i or 50p), or still image mode.

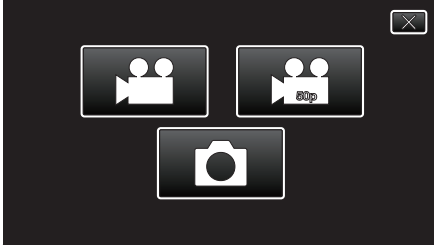

- If step 2 is not displayed, go to step 3.
- If the backup files of video (50i or 50p), or still image are not made, these icons won't be displayed.

- 3 Tap on the folder to play back.

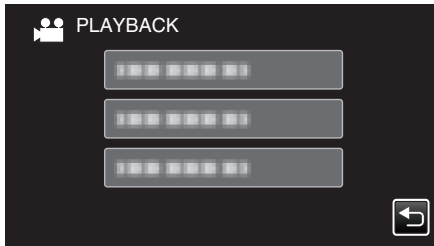

- Tap "←" to return to the "BACK-UP" menu.

- 4 Tap on the file to play back.

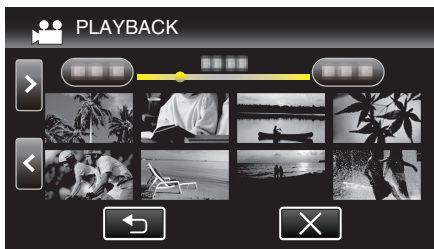

- Tap "←" to return to the folder index screen.
  - For details on video playback, refer to "Operation Buttons for Video Playback" (p. 45).
- "Operation Buttons for Video Playback" (p. 45)
- To exit, stop playback and turn off this unit. Then, disconnect the USB cable.

### Memo :

- Sound or video may be interrupted during playback.

### Deleting Folders in the USB External Hard Disk Drive

Files that are copied to the external hard disk drive can be deleted.

#### Caution :

- Deleted files cannot be restored.
  - Be sure to back up important files on a PC.
- "Copying to Mac Computer" (p. 94)

- 1 Select video or still image mode.
- 2 Tap "DELETE".

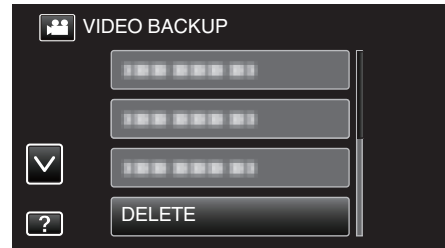

- While the video mode is shown in the image, the same operations apply for the still image mode.
- Tap the video camera icon to switch between the video (50i), video (50p), and still image modes. Switch to the mode in which you want to delete files.

- 3 Tap on the folder to delete.

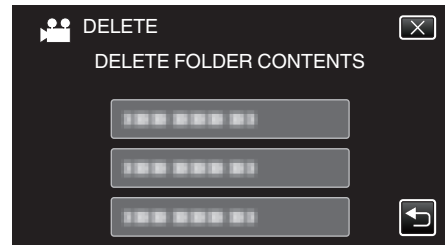

- 4 Tap "YES".

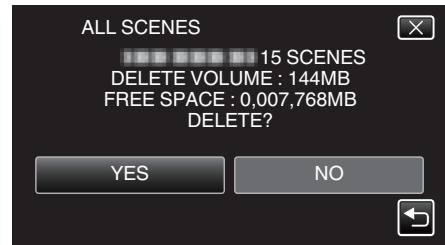

- After deleting, tap "OK".

## Formatting the USB External Hard Disk Drive

All files on the external hard disk drive can be deleted.

### Caution :

- All data on the external hard disk drive will be deleted when it is formatted. Copy all files on the card to a PC before formatting.

1 Select video or still image mode.

2 Tap "FORMAT".

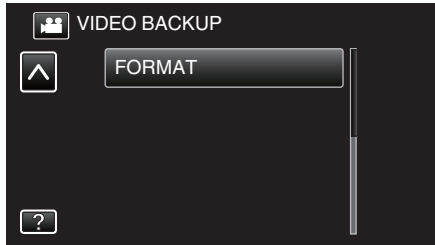

- While the video mode is shown in the image, the same operations apply for the still image mode.
- Tap the camera icon to switch between the video and still image modes.

3 Tap "YES".

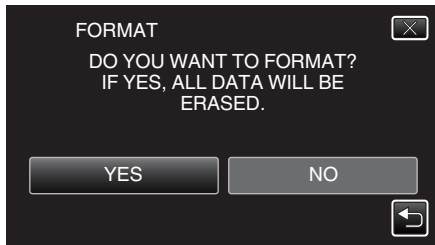

- After formatting, tap "OK".

## Copying to Windows PC

Copy the files to a computer using the following method.

- 1 Remove the AC adapter and battery pack from this unit.
- 2 Connect the USB cable and the AC adapter.

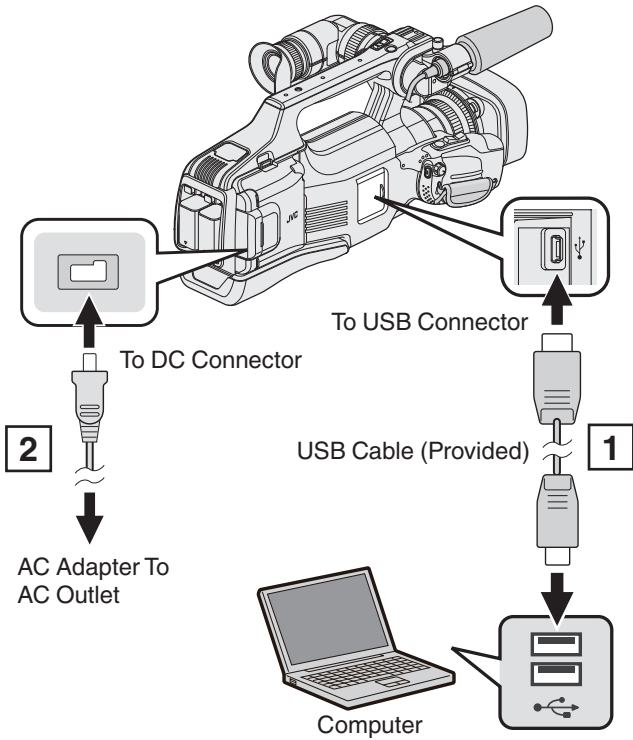

- 1 Connect using the provided USB cable.
- 2 Connect the AC adapter to this unit.

- 3 Set the "STANDBY/ON OFF" switch to "ON".

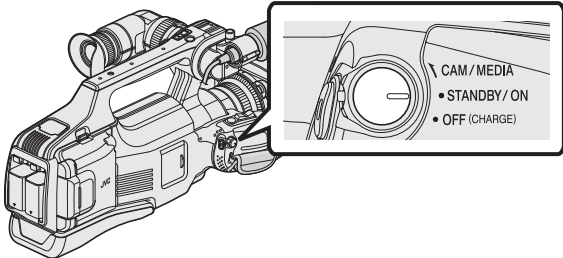

- When this unit is turned on, the "SELECT DEVICE" screen appears.

- 4 Tap "CONNECT TO PC".



- The following screen is displayed after the camera operation is completed.



- Operations are to be performed on the computer after the screen switches.

- 5 Select "Computer" (Windows Vista)/"My Computer" (Windows XP)/"Computer" (Windows 7) from the "Start" menu, then click on the "JVCCAM\_SD" icon.
  - Open the folder with the desired files.
  - "List of Files and Folders" (p. 93)
- 6 Copy the files to any folder in the computer (desktop, etc).

**Memo :**

- To edit/view the files, use a software that supports AVCHD (video)/JPEG (still image) files.
- The above operations on computer may vary with the system used.

### Disconnecting this Unit from Computer

- 1 Click "Safely Remove Hardware and Eject Media".

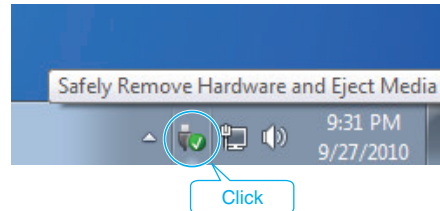

- 2 Click "Safely Remove USB Mass Storage Device".
- 3 (For Windows Vista) Click "OK".
- 4 Disconnect the USB cable from the computer.

**List of Files and Folders**

Folders and files are created in the SD card as shown below.  
They are created only when necessary.

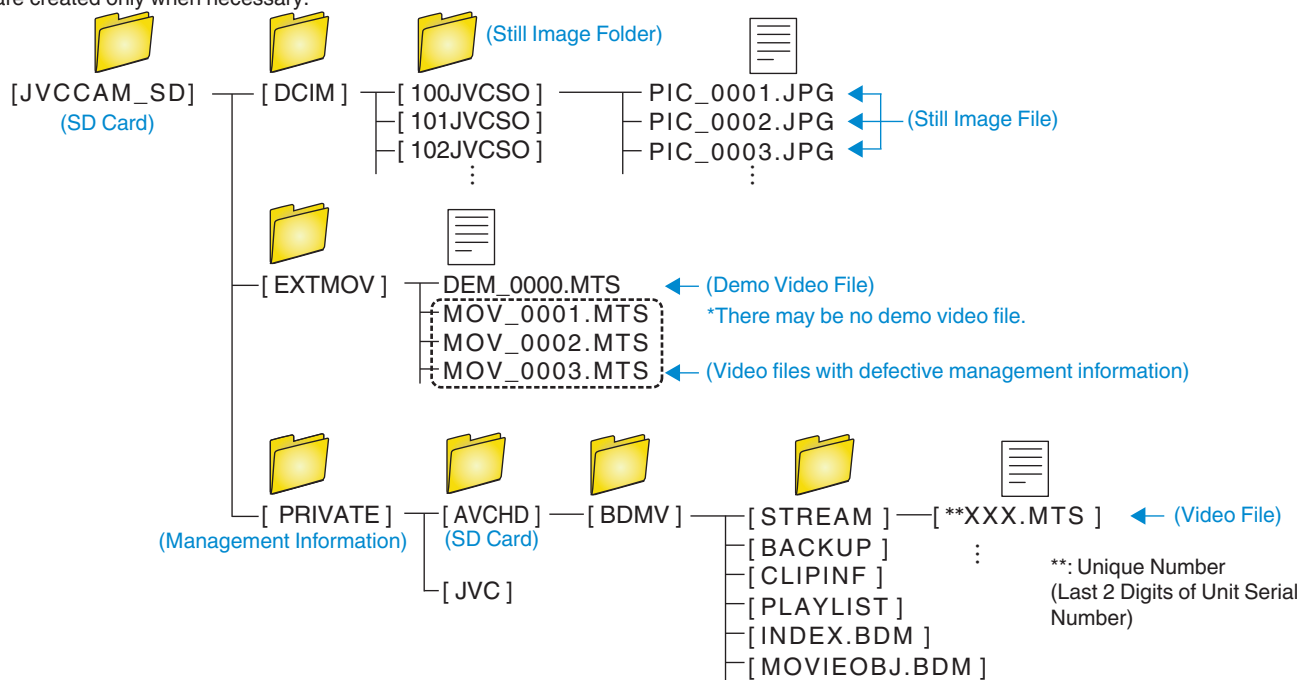

**Caution :**

- When the camera and PC are connected by an USB cable, recorded media are read-only.

## Copying to Mac Computer

Copy the files to a Mac computer using the following method.

- 1 Remove the AC adapter and battery pack from this unit.
- 2 Connect the USB cable and the AC adapter.

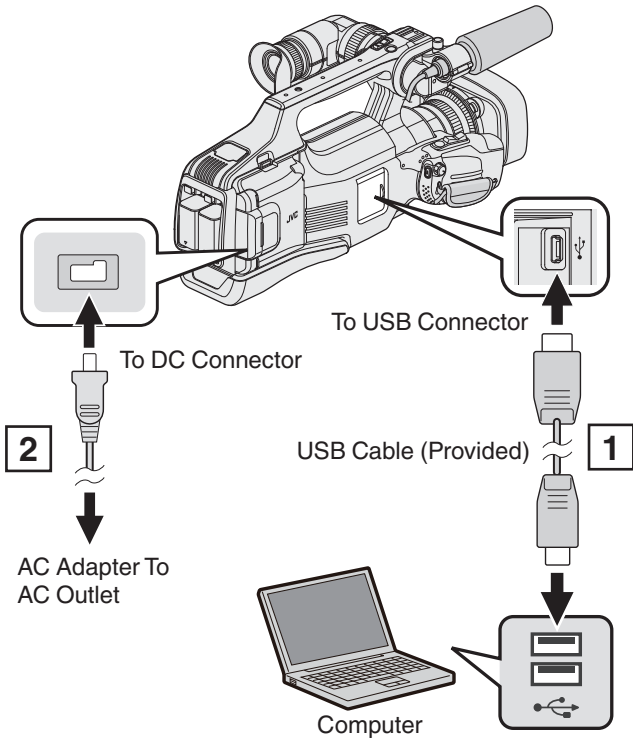

- 1 Connect using the provided USB cable.
- 2 Connect the AC adapter to this unit.

- 3 Set the "STANDBY/ON OFF" switch to "ON".

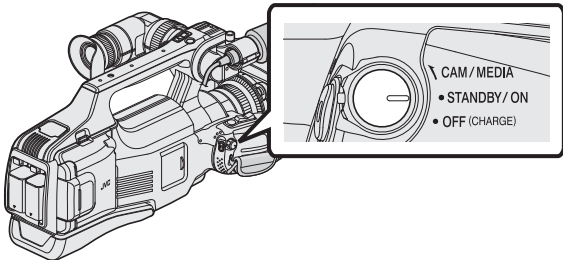

- When this unit is turned on, the "SELECT DEVICE" screen appears.

- 4 Tap "CONNECT TO PC".



- The following screen is displayed after the camera operation is completed.



- The "JVCCAM\_SD" icon appears on the desktop.

- 5 Start iMovie.

- The subsequent operations are to be performed on the Mac computer.

### Caution :

- When the camera and PC are connected by a USB cable, recorded media are read-only.
- MTS files that are copied to a Mac computer cannot be imported to iMovie. To use MTS files with iMovie, import the files using iMovie.
- Videos recorded in the 50p mode (when "SYSTEM SELECT" is set to "50p") are not supported.

### Memo :

- To edit/view the files, use a software that supports AVCHD (video)/JPEG (still image) files.
- When removing this unit from the computer, drag & drop the "JVCCAM\_SD" icon on the desktop to the trash bin.

### iMovie and iPhoto

You can import files from this unit to a computer using Apple's iMovie '08, '09, '11 (video) or iPhoto (still image). To verify the system requirements, select "About This Mac" from the Apple menu. You can determine the operating system version, processor and amount of memory.

- For the latest information on iMovie or iPhoto, refer to the Apple website.
- For details on how to use iMovie or iPhoto, refer to the help file of the respective software.
- There is no guarantee that the operations will work with all computer environments.

## Operating the Menu

There are two types of menus in this unit.

- TOP MENU: Menu that contains all the items specific to the video recording, still image recording, video playback, and still image playback modes respectively.
- SHORTCUT MENU: Menu that contains the recommended functions for video/still image recording.

### Operating the Top Menu

You can configure various settings using the menu.

1 Tap "MENU".



- The top menu appears.
- The menu differs according to the mode in use.

2 Tap the desired menu.

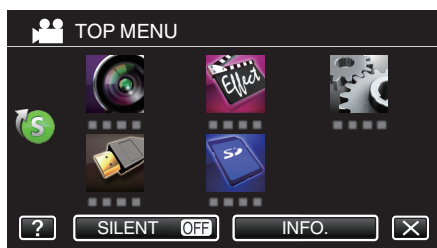

3 Tap the desired setting.

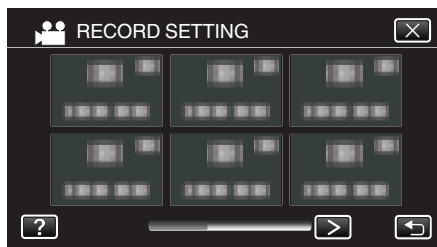

**Memo :**

- To display the previous/next menu  
Tap < or >.
  - To exit the screen  
Tap X (quit).
  - To display the help file  
Tap ? (help) and tap the item.
- Help file may not be available for some items.

## Operating the Shortcut Menu



You can configure various settings of the recommended functions in the video/still image recording mode using the shortcut menu.

1 Tap "MENU".

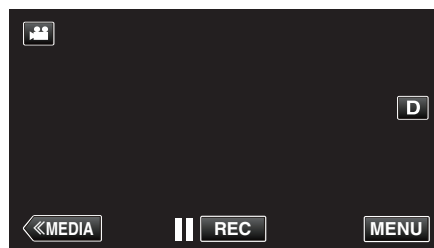

2 Tap the shortcut icon (S).



- The shortcut menu appears.

3 Tap the desired menu and setting.

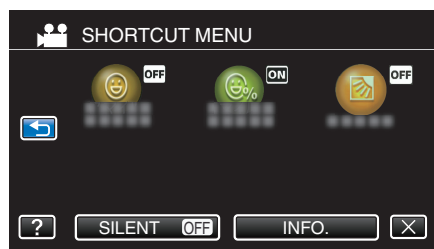

- Allows settings of "SMILE SHOT", "SMILE%" and "BACKLIGHT COMP."

**Memo :**

- To exit the screen  
Tap X (quit).
- To display the help file  
Tap ? (help) and tap the item.

### RECORD SETTING Menu (video)



#### SCENE SELECT

Settings to suit the shooting condition can be selected.

“Shooting According to Scene (Subject)” (☞ p. 32)

\*Displayed only in the manual recording mode.

#### FOCUS ASSIST

To adjust focus easily, the contour of focused parts are highlighted in color.

“Adjusting Focus by Using Focus Assist” (☞ p. 27)

#### ASSIST COLOR

Sets the color of contour line which is displayed in the “Focus Assist” function.

Setting	Details
RED	Sets the color of contour line to red.
GREEN	Sets the color of contour line to green.
BLUE	Sets the color of contour line to blue.

#### ZEBRA

Diagonal lines (zebra pattern) are displayed only at areas with the specified luminance levels.

“Displaying Zebra Pattern” (☞ p. 28)



#### SYSTEM SELECT

Sets whether to perform progressive recording of videos.

When progressive recording is set, high quality images with a smooth depth of field can be recorded. In addition, fast-moving subjects can also be captured sharply without flickering.

Setting	Details
50p	Records in progressive format.
50i	Does not record in progressive format.

#### Memo :

- Video quality cannot be set in the 50p mode.
- Videos that are recorded in the 50p mode are playable only on AVCHD Progressive compatible devices.
- Videos that are recorded in the 50p mode can only be copied to Blu-ray discs. (unable to be copied to DVD discs)
- Blu-ray discs containing videos that are recorded in the 50p mode are playable only on AVCHD Progressive compatible devices.
- You can also use the  (video)/ (still image) button on the touch screen to switch the mode.



**VIDEO QUALITY**

Sets the video quality.

Setting	Details
UXP	Enables recording in the best picture quality. (1920 x 1080 pixels) • Applies to Blu-ray discs only. Videos taken in high-definition quality cannot be saved to DVDs.
XP	Enables recording in high picture quality. (1920 x 1080 pixels)
SP	Enables recording in standard quality. (1920 x 1080 pixels)
EP	Enables long recordings. (1920 x 1080 pixels)
SSW	Enables recording in standard quality. (720 x 576 pixels)
SEW	Enables long recordings. (720 x 576 pixels)

**Memo :**

- The video quality becomes better in the order of “SEW”, “SSW”...“UXP”. And the recordable time to the SD card becomes longer in the order of “UXP”, “XP”...“SEW”.
- Set to “UXP” or “XP” mode when recording fast-moving scenes or scenes with extreme changes of brightness to avoid noise.
- Use an external Blu-ray drive to save videos recorded in “UXP” mode.
- Use an BD writer (external Blu-ray drive) to save videos recorded in “UXP” mode.
- You can change to the desired “VIDEO QUALITY” by tapping on it from the remaining recording time display.
- Video quality cannot be set in the 50p mode.

**BACKLIGHT COMP.**

Corrects the image when the subject appears dark due to backlight.  
“Setting Backlight Compensation” (☞ p. 29)

**TELE MACRO**

Enables close-up shots when using the telephoto (T) end of the zoom.

“Taking Close-up Shots” (☞ p. 33)

\*Displayed only in the manual recording mode.

**TOUCH PRIORITY AE/AF**

Automatically adjusts focus and brightness based on the subjects’ faces or selected area.

“Capturing Subjects Clearly (TOUCH PRIORITY AE/AF)” (☞ p. 34)

**IS**

Camera shake during video recording can be effectively reduced.

“Reducing Camera Shake” (☞ p. 37)

**GAIN UP**

Makes the subject appear bright automatically when recording in dark places.

Setting	Details
OFF	Deactivates the function.
ON	Electrically brightens the scene when it is dark.
AUTO SLOW-SHUTTER	Slows down the shutter speed to brighten the scene when it is dark.

**Memo :**

- Although “AUTO SLOW-SHUTTER” brightens the scene more than “ON”, movements of the subject may become unnatural.

## Menu Settings

### WIND CUT

Reduces the noise caused by wind.

Setting	Details
OFF	Deactivates the function.
ON	Activates the function.
AUTO	Activate the function automatically.

### GRID

Displays grid lines to identify tilt of the subject.

Setting	Details
OFF	Does not display grids.
ON	Displays grids.

### SHUTTER MODE

Continuous shooting settings can be adjusted.

Setting	Details
RECORD ONE SHOT	Records one still image.
CONTINUOUS SHOOTING	Records still images continuously while the SNAPSHOT button is pressed.

#### Memo :

- “LOW SPEED” is set in the video mode.
- The size of the still image that is captured in the video mode is 1,920 x 1,080.
- Some SD cards may not support continuous shooting.
- The continuous shooting speed will drop if this function is used repeatedly.

### SMILE SHOT

Automatically captures a still image upon detection of a smile.

“Capturing Smiles Automatically (SMILE SHOT)” (p. 35)

### SMILE%

Displays the smile level of people in percentage.



“Setting SMILE%” (p. 36)

### SEAMLESS RECORDING (Seamless recording/Auto recovery recording)

When “SEAMLESS RECORDING” is set to “ON” with two SD cards inserted, recordings can be made to the other media without stopping when the remaining recording time on current recording media runs out or when error occurs on the current recording media.

Setting	Details
OFF	Does not switch recording media automatically.
ON	Switches recording media automatically.

#### Memo :

- Seamless recording cannot be performed if there is not enough free space in the SD card.
-  appears if seamless recording is allowed.
- When only one SD card is being inserted, SEAMLESS RECORDING and auto recovery recording cannot be performed.  will appear.
- The icon does not appear when “SEAMLESS RECORDING” is set to “OFF”.
- Seamless recording cannot be performed when “HIGH SPEED RECORDING” or “TIME-LAPSE RECORDING” is set to “ON”.

**ZOOM**

Sets the maximum zoom ratio.

Setting	Details
10x OPTICAL	Enables recording with 1 - 10x optical zoom. Set this when digital zoom is not desired.
16(14)x DYNAMIC	Enables recording with 1 - 10x optical zoom and the following dynamic zoom. Zoom ratio varies according to the image stabilizer setting. "IS" OFF: 11 - 16x "IS" ON: 11 - 14x "IS" ON (AIS): 11 - 13x "IS" ON (Enhanced AIS): 1 - 10x optical zoom
39(34)x/DYNAMIC	Enables recording with 1 - 10x optical zoom and the following dynamic zoom. Zoom ratio varies according to the image stabilizer setting. "IS" OFF: 11 - 39x "IS" ON: 11 - 34x "IS" ON (AIS): 11 - 32x * Displayed only when "VIDEO QUALITY" is set to "SSW" or "SEW". In this case, "16(14)x DYNAMIC" is not displayed.
64x DIGITAL	Enables recording with 1 - 10x optical zoom and 11 - 64x digital zoom.
200x DIGITAL	Enables recording with 1 - 10x optical zoom and 11 - 200x digital zoom.

**Memo :**

- When digital zoom is used, the image becomes grainy as it is digitally enlarged.
- The angle of view changes when the image stabilizer is turned on or off.

**x.v.Color**

Captures the true colors.

(Use an x.v.Color compatible TV for playback.)

Setting	Details
OFF	Captures colors with the same standard as TV broadcasting.
ON	Captures the true colors. (for TVs that supports x.v.Color)

**ZOOM MIC**

Sets the zoom microphone.

Setting	Details
OFF	Deactivates the zoom microphone.
ON	Records audio sounds in the same direction as the zoom operation.

**MIC LEVEL METER**

Make the adjustments such that "MIC LEVEL METER" does not turn red.

Setting	Details
OFF	Hides display of microphone input level.
ON	Shows display of microphone input level.

## Menu Settings

### MIC LEVEL SETTING

Sets the microphone level.  
Make the adjustments such that "MIC LEVEL METER" does not turn red.

Setting	Details
+2	Increases the microphone input level.
+1	Increases the microphone input level slightly.
0	The microphone input level is not changed.
-1	Decreases the microphone input level slightly.
-2	Decreases the microphone input level.

### K2 TECHNOLOGY

Reduces the degradation of sound quality caused by digital signal processing, and records a sound quality close to the original.

Setting	Details
OFF	Deactivates K2 TECHNOLOGY.
ON	Activates K2 TECHNOLOGY.

## SPECIAL RECORDING Menu (video)



### HIGH SPEED RECORDING

You can record videos in slow-motion by increasing the recording speed to emphasize the movements, and play back the slow-motion video smoothly. This is a handy function for checking movements, such as golf swings.  
"Slow-motion (High-speed) Recording" (☞ p. 38)

### TIME-LAPSE RECORDING

Enables the changes of a scene that occur slowly over a long period to be shown within a short time by taking frames of it at a certain interval. This is useful for making observations such as the opening of a flower bud.  
"Recording at Intervals (TIME-LAPSE RECORDING)" (☞ p. 39)

### AUTO REC

Starts recording automatically by sensing the changes in subject's movement (brightness) within the red frame displayed on the LCD monitor.  
"Recording Automatically by Sensing Movements (AUTO REC)" (☞ p. 40)

## RECORD SETTING Menu (still image)



### SCENE SELECT

Settings to suit the shooting condition can be selected.

“Shooting According to Scene (Subject)” (☞ p. 32)

\*Displayed only in the manual recording mode.

### FOCUS ASSIST

To adjust focus easily, the contour of focused parts are highlighted in color.

“Adjusting Focus by Using Focus Assist” (☞ p. 27)

### ASSIST COLOR

Sets the color of contour line which is displayed in the “Focus Assist” function.

Setting	Details
RED	Sets the color of contour line to red.
GREEN	Sets the color of contour line to green.
BLUE	Sets the color of contour line to blue.

### BACKLIGHT COMP.

Corrects the image when the subject appears dark due to backlight.

“Setting Backlight Compensation” (☞ p. 29)

### TELE MACRO

Enables close-up shots when using the telephoto (T) end of the zoom.

“Taking Close-up Shots” (☞ p. 33)

\*Displayed only in the manual recording mode.

### TOUCH PRIORITY AE/AF

Automatically adjusts focus and brightness based on the subjects’ faces or selected area.

“Capturing Subjects Clearly (TOUCH PRIORITY AE/AF)” (☞ p. 34)

### SELF-TIMER

Use this when taking a group photo.

“Taking Group Shots (Self-timer)” (☞ p. 41)

### GRID

Displays grid lines to identify tilt of the subject.

Setting	Details
OFF	Does not display grids.
ON	Displays grids.

## Menu Settings

### GAIN

Sets the ISO level according to the brightness of the subject.

Setting	Details
AUTO	Sets the gain automatically.
ISO50	Sets to ISO50.
ISO100	Sets to ISO100.
ISO200	Sets to ISO200.
ISO400	Sets to ISO400.
ISO800	Sets to ISO800.
ISO1600	Sets to ISO1600.
ISO3200	Sets to ISO3200.
ISO6400	Sets to ISO6400.

### IS

Camera shake during still image recording can be effectively reduced.

“Reducing Camera Shake” (p. 37)

### SHUTTER MODE

Continuous shooting settings can be adjusted.

Setting	Details
RECORD ONE SHOT	Records one still image.
CONTINUOUS SHOOTING	Records still images continuously while the SNAPSHOT button is pressed.

#### Memo :

- The continuous shooting speed can be changed.  
“CONT. SHOOTING SPEED” (p. 102)
- Continuous shooting is not available when image size is set to 4000x3000.
- Some SD cards may not support continuous shooting.
- The continuous shooting speed will drop if this function is used repeatedly.

### CONT. SHOOTING SPEED

Sets the speed for continuous shooting.

Setting	Details
HIGH SPEED	Shoots up to 95 still images continuously in the still image mode in about 7.6 second.
MEDIUM SPEED	Shoots up to 95 still images continuously in the still image mode in about 15.2 second.
LOW SPEED	Shoots continuously until the recording media is full.

#### Memo :

- Shooting speed slows down gradually as continuous shooting goes on in the “LOW SPEED” mode.
- When the size of the still image is set to 2816X2112(5.9M), shooting speed is set to “LOW SPEED” temporarily.

**SMILE SHOT**

Automatically captures a still image upon detection of a smile.  
 "Capturing Smiles Automatically (SMILE SHOT)" (☞ p. 35)

**SMILE%**

Displays the smile level of people in percentage.  
 "Setting SMILE%" (☞ p. 36)

**IMAGE SIZE**

Sets the image size (number of pixels) for still images.

Setting	Details
1920X1080(2.1M)	Takes still images with aspect ratio 16:9. <ul style="list-style-type: none"> <li>• The sides of still images recorded in 16:9 aspect ratio may be cut off when printed.</li> </ul>
4000X3000(12M) 2816X2112(5.9M) 2048X1536(3.1M) 640X480(0.3M)	Takes still images with aspect ratio 4:3.

**SPECIAL RECORDING Menu (still image)****AUTO REC**

Starts recording automatically by sensing the changes in subject's movement (changes in brightness) within the red frame displayed on the LCD monitor.  
 "Recording Automatically by Sensing Movements (AUTO REC)" (☞ p. 40)

### PLAYBACK SETTING Menu (video)



#### SEARCH DATE

Narrows down the video index screen according to recording dates.  
“Searching for a Specific Video/Still Image by Date” (☞ p. 54)

#### DISPLAY DATE/TIME

Sets whether to display the recording date and time during video playback.

Setting	Details
OFF	Does not display the date and time during playback.
ON	Displays the date and time during playback.

#### DIGEST PLAYBACK

Plays back a digest of the recorded videos.  
“DIGEST PLAYBACK” (☞ p. 49)

#### PLAYBACK PLAYLIST

Play back the playlists that you have created.  
“PLAYBACK PLAYLIST” (☞ p. 50)

#### PLAYBACK OTHER FILE

Plays videos with defective management information.  
“PLAYBACK OTHER FILE” (☞ p. 51)

### EDIT Menu (video)



#### PROTECT/CANCEL

Protects files from being deleted accidentally.  
“Protecting/Releasing Protection of the Currently Displayed File” (☞ p. 60)  
“Protecting/Releasing Protection of Selected Files” (☞ p. 60)

#### EDIT PLAYLIST

A list in which your favorite videos are arranged is called a playlist.  
By creating a playlist, you can play back only your favorite videos in the order you like.  
The original video file remains even when it is registered to a playlist.  
“Creating Playlists with Selected Files” (☞ p. 63)  
“Creating Playlists by Date” (☞ p. 64)  
“Editing Playlists” (☞ p. 66)

#### TRIMMING

Select the required part of a video and save it as a new video file.  
The original video remains in its existing location.  
“Capturing a Required Part in the Video (TRIMMING)” (☞ p. 62)



## PLAYBACK SETTING Menu (still image)



### SEARCH DATE

Narrows down the still image index screen according to recording dates.  
 “Searching for a Specific Video/Still Image by Date” (☞ p. 54)

### SLIDE SHOW EFFECTS

Sets the transition effects in slideshow playback.

Setting	Details
SLIDE	Switches the screen by sliding in from right to left.
BLINDS	Switches the screen by dividing into vertical strips.
CHECKERBOARD	Switches the screen by changing through a checkered pattern.
RANDOM	Switches the screen with a random effect from “SLIDE”, “BLINDS”, and “CHECKERBOARD”.

### Memo :

- Slideshow effects are not available when playing back still images in external devices (such as USB external hard disk drives).

## EDIT Menu (still image)



### PROTECT/CANCEL

Protects files from being deleted accidentally.  
 “Protecting/Releasing Protection of the Currently Displayed File” (☞ p. 60)  
 “Protecting/Releasing Protection of Selected Files” (☞ p. 60)

## SETUP (video/still image)



### CLOCK ADJUST

Resets the current time or sets to the local time when using this unit overseas.

“Clock Setting” (☞ p. 12)

“Setting the Clock to Local Time when Traveling” (☞ p. 16)

“Setting Daylight Saving Time” (☞ p. 17)

### DATE DISPLAY STYLE

Sets the order of year, month, day and the time display format (24H/12H).

Sorting Order	Time Display
month.day.year	12h / 24h
year.month.day	12h / 24h
day.month.year	12h / 24h

### LANGUAGE

The language on the display can be changed.

“Changing the Display Language” (☞ p. 13)

### MONITOR BRIGHTNESS

Sets the brightness of the LCD monitor.

Setting	Details
AUTO	Sets the brightness automatically to “4” when using outdoors and to “3” when using indoors.
4	Brightens the backlight of the monitor regardless of the surrounding conditions.
3	Sets to the standard brightness.
2	Darkens the backlight of the monitor regardless of the surrounding conditions.
1	Sets to dim brightness. Helps to save battery life when selected.

### OPERATION SOUND

Turns on or off the operation sound.

Setting	Details
OFF	Turns off the operation sound.
ON	Enables SUB REC BUTTON.

**AUTO POWER OFF**

Prevents the situation of forgetting to turn off the power when this is set.

Setting	Details
OFF	Power is not turned off even if this unit is not operated for 5 minutes.
ON	Turns off the power automatically if this unit is not operated for 5 minutes.

**Memo :**

- When using battery, power is turned off automatically if this unit is not operated for 5 minutes.
- When using the AC adapter, this unit goes into standby mode.

**TALLY LAMP**

Sets whether to turn on the tally lamp during recording.

Setting	Details
OFF	Tally lamp does not light up.
ON	Tally lamp lights up during recording.

**TOUCH SCREEN ADJUST**

Adjusts the response position of the buttons on the touch screen.  
 “Adjusting the Touch Panel” (p. 8)

**FACTORY PRESET**

Returns all the settings to their default values.

**FIRMWARE UPDATE**

Updates the functions of this unit to the latest version.

For details, refer to the JVC homepage.

(When no program to update the software of this unit is available, nothing will be provided on the homepage.)

<http://www3.jvckenwood.com/english/support/index.html>

### CONNECTION SETTINGS (video/still image)

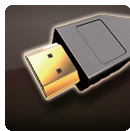

#### DISPLAY ON TV

Displays icons and date/time on a TV screen.

Setting	Details
OFF	Does not display icons and date/time on TV.
ON	Displays icons and date/time on TV.

#### VIDEO OUTPUT

Sets the aspect ratio (16:9 or 4:3) according to the connecting TV.

Setting	Details
4:3	Select this when connecting to a conventional TV (4:3).
16:9	Select this when connecting to a widescreen TV (16:9).

#### HDMI OUTPUT

Sets the output from the HDMI connector of this unit when it is connected to a TV.

Setting	Details
AUTO	It is recommended to select "AUTO" usually.
576p	Select this when the video is not output in "AUTO" correctly.

#### HDMI CONTROL

Sets whether to link operations with an HDMI-CEC compliant TV.

Setting	Details
OFF	Turns off linked operations.
ON	Turns on linked operations.

## MEDIA SETTINGS (video/still image)



### REC VIDEO TO SLOTS

Sets the recording/playback media of videos.

Setting	Details
SLOT A	Records videos to the SD card in slot A.
SLOT B	Records videos to the SD card in slot B.

### REC STILLS TO SLOTS

Sets the recording/playback media of still images.

Setting	Details
SLOT A	Records still images to the SD card in slot A.
SLOT B	Records still images to the SD card in slot B.

### FORMAT SD CARD

Deletes all files on the SD card.

Setting	Details
FILE	Deletes all files on the SD card.
FILE + MANAGEMENT NO	Deletes all files on the SD card and resets the folder and file numbers to "1".

#### Caution :

- Not available for selection when no SD card is inserted.
- All data on the SD card will be deleted when it is formatted.  
Copy all files on the SD card to a computer before formatting.
- Make sure that the battery pack is fully charged or connect the AC adapter as the formatting process may take some time.
- SD cards used on other devices cannot be used on this unit.  
Format the card before using.

Front

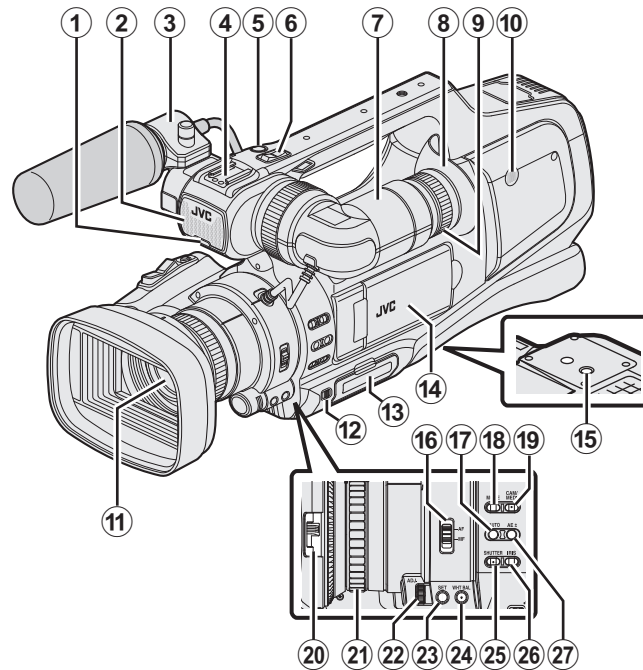

\* Microphone is optional.

**1 Tally lamp**

“TALLY LAMP” (☞ p. 107)

**2 Built-in microphone**

**3 Microphone holder**

“Attaching the External Microphone” (☞ p. 15)

**4 Shoe**

**5 “REC” (Record) button**

“Taking Videos in Auto Mode” (☞ p. 20)

**6 Zoom lever**

“Zooming” (☞ p. 26)

**7 Viewfinder**

“Viewing with the viewfinder” (☞ p. 14)

**8 Eyepiece**

**9 Eyepiece focus lever**

**10 Built-in speaker**

**11 Lens/Lens cover**

**12 “DOOR LOCK” lever**

**13 SD card slot A, B**

“Inserting an SD Card” (☞ p. 6)

**14 LCD monitor**

“Using the Touch Screen” (☞ p. 8)

“Viewing on LCD monitor” (☞ p. 14)

**15 Tripod mounting holes**

“Tripod Mounting” (☞ p. 15)

**16 “AF/MF” Focus switch**

“Selecting Focus Mode” (☞ p. 18)

**17 i.AUTO (Intelligent Auto) button**

“Selecting Intelligent Auto/Manual Recording Mode” (☞ p. 18)

**18 MODE (Video/Still image) button**

“Selecting Video/Still Image Recording Mode” (☞ p. 19)

**19 “CAM”/“MEDIA” button**

- During recording: Switches to the media (playback) mode.
- During playback: Switches to the camera (recording) mode.

**20 Lens cover switch**

“Opening the Lens Cover” (☞ p. 14)

**21 Focus ring**

“Adjusting Focus Manually” (☞ p. 27)

**22 “ADJ.” dial**

**23 “SET” Button**

**24 “WHT BAL” White balance selection button**

“Setting White Balance” (☞ p. 31)

**25 “SHUTTER” Shutter speed button**

“Adjusting Shutter Speed” (☞ p. 30)

**26 “IRIS” Iris button**

“Adjusting Aperture” (☞ p. 30)

**27 “AE±” Exposure button**

“Adjusting Brightness Manually” (☞ p. 29)

## Rear

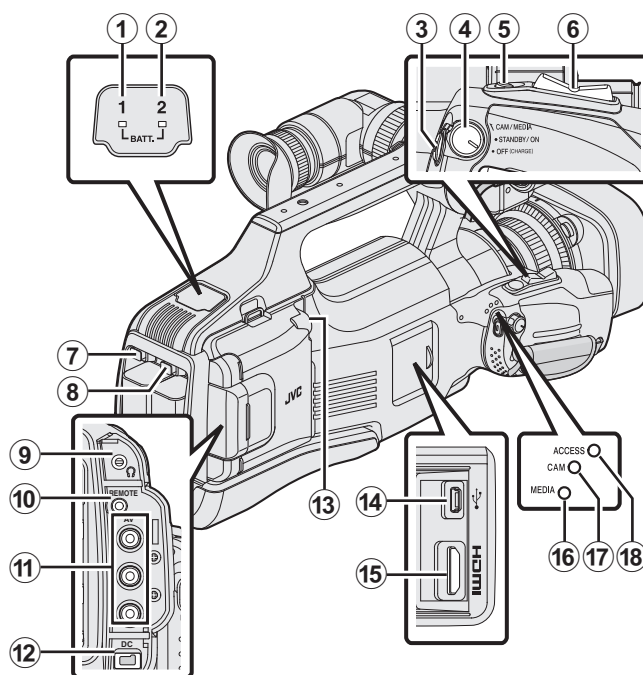

❶ “BATT. 1” charge indicating lamp

❷ “BATT. 2” charge indicating lamp

“Charging the Battery Pack” (☞ p. 5)

❸ “REC” (Record) button

“Taking Videos in Auto Mode” (☞ p. 20)

❹ “STANDBY/ON OFF”/“CAM/MEDIA”

Power/Operation mode selection switch

“Turning On/Off the Power” (☞ p. 11)

❺ “SNAPSHOT” (Still image recording) button

“Taking Still Images in Auto Mode” (☞ p. 24)

❻ Zoom lever

“Zooming” (☞ p. 26)

❼ “BATT. 1” lock release button

❽ “BATT. 2” lock release button

“Charging the Battery Pack” (☞ p. 5)

❾ Headphone jack

“Attaching the Headphones” (☞ p. 15)

❿ “REMOTE” Remote terminal

“Preparing the Remote Control” (☞ p. 15)

⓫ “AV” connector

“Connecting via the AV Connector” (☞ p. 57)

“Dubbing Files to a Disc by Connecting to a DVD Recorder” (☞ p. 85)

“Dubbing Files to a VHS Tape by Connecting to a VCR” (☞ p. 86)

⓬ “DC” connector

“Charging the Battery Pack” (☞ p. 5)

⓭ “MIC” jack

“Attaching the External Microphone” (☞ p. 15)

⓮ USB connector

“Creating Discs with a BD Writer (External Blu-ray Drive)” (☞ p. 69)

“Creating Discs with a DVD Writer” (☞ p. 77)

“Creating a Disc Using a Connected Blu-ray Recorder” (☞ p. 84)

“Using a USB External Hard Disk Drive” (☞ p. 87)

“Copying to Windows PC” (☞ p. 92)

“Copying to Mac Computer” (☞ p. 94)

⓯ HDMI connector

“Connecting via the HDMI Connector” (☞ p. 55)

⓰ “MEDIA” Media mode indicating lamp

⓱ “CAM” Camera mode indicating lamp

⓲ “ACCESS” Access indicating lamp

## Common Recording Indications

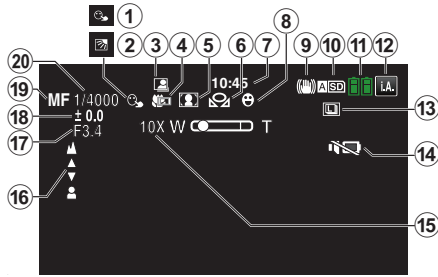

- 1 TOUCH PRIORITY AE/AF**  
“Capturing Subjects Clearly (TOUCH PRIORITY AE/AF)” (☞ p. 34)
- 2 BACKLIGHT COMP.**  
“Setting Backlight Compensation” (☞ p. 29)
- 3 Auto REC**  
“Recording Automatically by Sensing Movements (AUTO REC)” (☞ p. 40)
- 4 Tele Macro**  
“Taking Close-up Shots” (☞ p. 33)
- 5 SCENE SELECT**  
“Shooting According to Scene (Subject)” (☞ p. 32)
- 6 WHITE BALANCE**  
“Setting White Balance” (☞ p. 31)
- 7 Time**  
“Clock Setting” (☞ p. 12)
- 8 SMILE SHOT**  
“Capturing Smiles Automatically (SMILE SHOT)” (☞ p. 35)
- 9 IS**  
“Reducing Camera Shake” (☞ p. 37)
- 10 Media**  
“REC VIDEO TO SLOTS ” (☞ p. 109)  
“REC STILLS TO SLOTS ” (☞ p. 109)
- 11 Battery Indicator**  
“Checking the Remaining Recording Time” (☞ p. 43)
- 12 Recording Mode**  
“Taking Videos in Auto Mode” (☞ p. 20)  
“Selecting Intelligent Auto/Manual Recording Mode” (☞ p. 18)
- 13 Continuous Shooting**  
“SHUTTER MODE (Still Image)” (☞ p. 102)
- 14 SILENT MODE**  
“Using the Silent Mode” (☞ p. 22)
- 15 Zoom**  
“ZOOM ” (☞ p. 99)
- 16 FOCUS**  
“Adjusting Focus Manually” (☞ p. 27)
- 17 APERTURE PRIORITY**  
“Adjusting Aperture” (☞ p. 30)
- 18 BRIGHTNESS ADJUST**  
“Adjusting Brightness Manually” (☞ p. 29)
- 19 Focus Mode**  
“Adjusting Focus Manually” (☞ p. 27)
- 20 Shutter Speed**  
“Adjusting Shutter Speed” (☞ p. 30)

## Video Recording

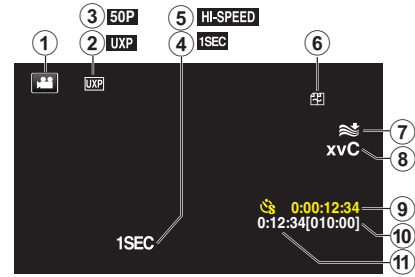

- 1 Video Mode**  
Switches between video (50i/50p) and still image modes.
- 2 VIDEO QUALITY**  
“VIDEO QUALITY ” (☞ p. 97)
- 3 Progressive Recording**  
“System Select” (☞ p. 96)
- 4 TIME-LAPSE RECORDING(1SEC)**  
“Recording at Intervals (TIME-LAPSE RECORDING)” (☞ p. 39)
- 5 HIGH SPEED RECORDING**  
“Slow-motion (High-speed) Recording” (☞ p. 38)
- 6 Seamless Recording**  
“SEAMLESS RECORDING (Seamless recording/Auto recovery recording)” (☞ p. 98)
- 7 WIND CUT**  
“WIND CUT ” (☞ p. 98)
- 8 x.v.Color**  
“x.v.Color ” (☞ p. 99)
- 9 Time-Lapse Recording Counter**  
“Recording at Intervals (TIME-LAPSE RECORDING)” (☞ p. 39)
- 10 Remaining Recording Time**  
“Checking the Remaining Recording Time” (☞ p. 43)
- 11 Scene Counter**



## Still Image Recording

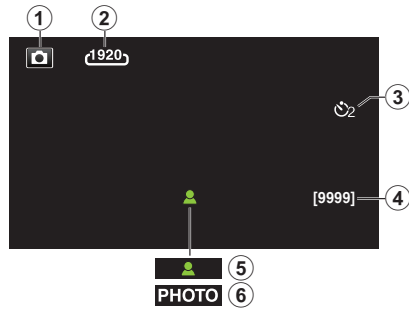

### 1 Still Image Mode

Switches between video (50i/50p) and still image modes.

### 2 IMAGE SIZE

"IMAGE SIZE" (p. 103)

### 3 SELF-TIMER

"Taking Group Shots (Self-timer)" (p. 41)

### 4 Remaining Number of Shots

"Checking the Remaining Recording Time" (p. 44)

### 5 Focus

### 6 Recording in Progress

## Video Playback

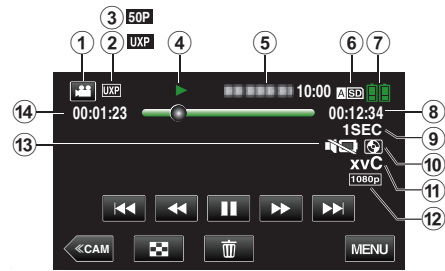

### 1 Video Mode

Switches between video (50i/50p) and still image modes.

### 2 Video Quality

"VIDEO QUALITY" (p. 97)

### 3 Progressive Recording

"System Select" (p. 96)

### 4 Operation Indicator

"Operation Buttons for Video Playback" (p. 45)

### 5 Date/Time

- Displays the recording date and time.

### 6 Media

"REC VIDEO TO SLOTS" (p. 109)

### 7 Battery Indicator

"Checking the Remaining Recording Time" (p. 43)

### 8 Playback Time

"Playing Back Videos" (p. 45)

### 9 Time-Lapse Playback

"Time-Lapse Setting" (p. 40)

### 10 External Storage Playback

"Playing Back with a DVD Writer" (p. 83)

"Playing Back with a BD Writer (External Blu-ray Drive)" (p. 77)

"Playing Back Files in the USB External Hard Disk Drive" (p. 90)

### 11 x.v.Color

"x.v.Color" (p. 99)

### 12 1080p Output

"HDMI OUTPUT" (p. 108)

### 13 SILENT MODE

"Using the Silent Mode" (p. 22)

### 14 Scene Counter

## Still Image Playback



**1 Still Image Mode**

Switches between video (50i/50p) and still image modes.

**2 Folder Number**

**3 File Number**

**4 Date/Time**

- Displays the recording date and time.

**5 Media**

“REC STILLS TO SLOTS” (see p. 109)

**6 Battery Indicator**

“Checking the Remaining Recording Time” (see p. 43)

**7 SILENT MODE**

“Using the Silent Mode” (see p. 22)

**8 External Storage Playback**

“Playing Back with a DVD Writer” (see p. 83)

“Playing Back with a BD Writer (External Blu-ray Drive)” (see p. 77)

“Playing Back Files in the USB External Hard Disk Drive” (see p. 90)

**9 1080p Output**

“HDMI OUTPUT” (see p. 108)

## When the unit is not working properly

### Turning Off the Power

- 1 Set the "STANDBY/ON OFF" switch to "OFF".

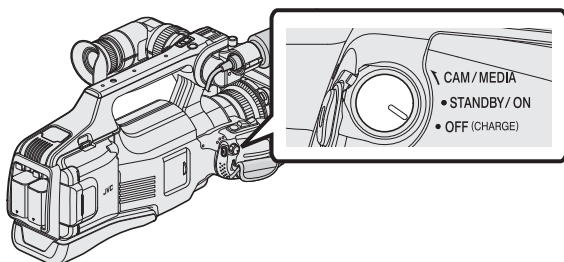

- 2 Remove the power source (battery and AC adapter), connect these again, and then turn on the power. (Reset completed)

### Recording in Intelligent Auto Mode

- 1 Check if the recording mode is **i.A.**, Intelligent Auto.

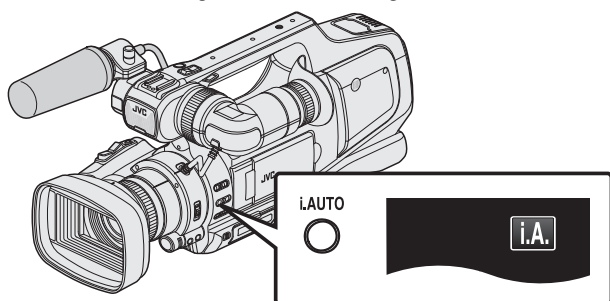

- If Manual (**M**) is activated, switch to Intelligent Auto (**i.A.**). "Selecting Intelligent Auto/Manual Recording Mode" (p. 18)

- 2 Start recording.

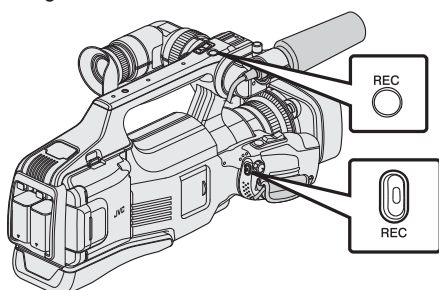

- Press again to stop.

### Returning All Settings to Default Values

- 1 Tap "MENU".

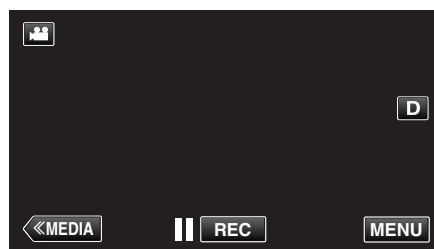

- 2 Tap "SETUP".

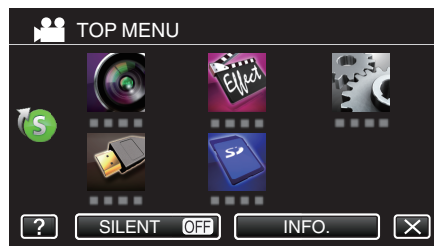

- 3 Tap "FACTORY PRESET".



- 4 Tap "YES".

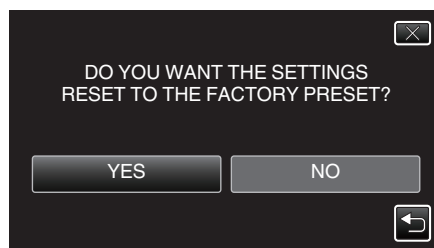

- All settings return to their default values.

#### Memo :

- If the above do not solve the problem, consult the JVC Customer Support Center.

### Battery Pack

#### Unable to turn on the power when using the battery pack.

Recharge the battery pack.

“Charging the Battery Pack” (☞ p. 5)

If the terminal of this unit or the battery pack is dirty, wipe it with a cotton swab or something similar.

If you use any other battery packs besides JVC battery packs, safety and performance cannot be guaranteed. Be sure to use JVC battery packs.

#### Short usage time even after charging.

Battery deterioration occurs when a battery pack is charged repeatedly.

Replace the battery pack with a new one.

“Optional Accessories” (☞ p. 17)

#### Unable to charge the battery pack.

When the battery pack is fully charged, the lamp does not flash.

If the terminal of this unit or the battery pack is dirty, wipe it with a cotton swab or something similar.

Using a non-original AC adapter may result in damage to this unit. Be sure to use an original AC adapter.

#### The remaining battery display is not correct.

Remaining battery power is not displayed when the AC adapter is connected.

If this unit is used for long periods of time in high or low temperatures, or if the battery pack is repeatedly charged, the amount of remaining battery may not be displayed correctly.

#### The charging lamp blinks in a slow cycle.

If the battery pack is charged outside the room temperature range of 10°C to 35°C, charging may take a longer time or it may not start. CHARGE lamp blinks 2 times in a slow cycle for notification if the battery charge does not start.

#### The charging lamp blinks quickly.

If malfunctions (overvoltage, etc) occur, or if any battery manufactured other than by JVC is attempted for battery charge, charging stops. In these cases, the CHARGE lamp blinks quickly for notification.

### Recording

#### Recording cannot be performed.

Check the “MODE” button.

When there are multiple light sources and depending on the shooting conditions, exposure and focus may not be adjusted correctly in the Intelligent Auto mode. In this case, adjust the settings manually.

“Adjusting Focus Manually” (☞ p. 27)

#### Recording stops automatically.

Recording stops automatically as it cannot be performed for 12 or more consecutive hours according to specifications. (It may take some time to resume recording.)

Turn off this unit, wait for a while, and turn it on again. (This unit stops automatically to protect the circuit when the temperature rises.)

#### The continuous shooting speed of still images is slow.

The continuous shooting speed will drop if this function is used repeatedly. Continuous shooting speed may drop depending on the SD card or under certain recording conditions.

#### The focus is not adjusted automatically.

If you are recording in a dark place or a subject that has no contrast between dark and light, adjust the focus manually.

“Adjusting Focus Manually” (☞ p. 27)

Wipe the lens with a lens cleaning cloth.

Cancel manual focus on the manual recording menu.

“Adjusting Focus Manually” (☞ p. 27)

#### Zoom does not work.

Digital zoom is not available in the still image recording mode.

Zoom operation is not available in time-lapse recording. (Simultaneous still image recording and image stabilizer are also not available.)

To use digital zoom, set “ZOOM” in the menu accordingly.

“ZOOM” (☞ p. 99)

#### Mosaic-type noise occurs when recording scenes with fast movements or extreme changes in brightness.

Set the “VIDEO QUALITY” to “UXP” or “XP” for recording.

“VIDEO QUALITY” (☞ p. 97)

## Card

### Cannot insert the SD card.

Make sure not to insert the card in the wrong direction.  
 “Inserting an SD Card” (☞ p. 6)

### Unable to copy to SD card.

To record to the card, it is necessary to perform media settings.  
 Set “REC VIDEO TO SLOTS”/“REC STILL TO SLOTS” to the correct setting.  
 “REC VIDEO TO SLOTS” (☞ p. 109)  
 “REC STILL TO SLOTS” (☞ p. 109)  
 To use cards that have been used on other devices, it is necessary to format (initialize) the card using “FORMAT SD CARD” from media settings.  
 “FORMAT SD CARD” (☞ p. 109)

## Playback

### Sound or video is interrupted.

Sometimes playback is interrupted at the connecting section between two scenes. This is not a malfunction.

### There is no sound.

When the Silent mode is used, operation and playback sounds will not be output. Turn off the Silent mode.  
 “Using the Silent Mode” (☞ p. 22)  
 Set “OPERATION SOUND” in the common menu to “ON”.  
 “OPERATION SOUND” (☞ p. 106)  
 Audio sound is not recorded for videos taken in HIGH SPEED RECORDING/TIME-LAPSE RECORDING.  
 “Slow-motion (High-speed) Recording” (☞ p. 38)  
 “Recording at Intervals (TIME-LAPSE RECORDING)” (☞ p. 39)

### The same image is displayed for a long time.

Use a high speed SD card (Class 4 or higher).  
 “Types of Usable SD Card” (☞ p. 7)  
 Clean the terminals of the SD card with a dry cotton swab or something similar.  
 Execute “FORMAT SD CARD” in the “MEDIA SETTINGS” menu. (All data will be deleted.)  
 “FORMAT SD CARD” (☞ p. 109)

### The motion is choppy.

Use a high speed SD card (Class 4 or higher).  
 “Types of Usable SD Card” (☞ p. 7)  
 Clean the terminals of the SD card with a dry cotton swab or something similar.  
 Execute “FORMAT SD CARD” in the MEDIA SETTINGS menu. (All data will be deleted.)  
 “FORMAT SD CARD” (☞ p. 109)

### Cannot find a recorded file.

Cancel the date search function.  
 “Searching for a Specific Video/Still Image by Date” (☞ p. 54)  
 Change the playback media by tapping **A|SD|B|SD** on the touch screen.  
 “Operation Buttons for Video Playback” (☞ p. 45)  
 “Operation Buttons for Still Image Playback” (☞ p. 52)  
 Select “PLAYBACK OTHER FILE” in the menu. (Video files that have damaged management information can be played back.)  
 “PLAYBACK OTHER FILE” (☞ p. 51)  
 Images recorded in 50p mode and 50i mode are displayed on the index screen separately.  
 To switch between the 50p mode and 50i mode index screen (thumbnail display), tap .  
 In cases such as during Digest Playback or when playing back/editing a playlist, select the 50p mode and 50i mode before operating.

### Images do not appear on the TV properly.

Disconnect the cable and connect again.

“Connecting via the HDMI Connector” (☞ p. 55)

Turn off and on this unit again.

### Images are projected vertically on the TV.

Set “VIDEO OUTPUT” in the “MEDIA SETTINGS” menu to “4:3”.

“VIDEO OUTPUT” (☞ p. 108)

Adjust the TV’s screen accordingly.

### The image displayed on TV is too small.

Set “VIDEO OUTPUT” in the “MEDIA SETTINGS” menu to “16:9”.

“VIDEO OUTPUT” (☞ p. 108)

### When connected to the TV via the HDMI cable, proper images and sounds are not output.

Images and sounds may not be output properly depending on the TV connected. In such cases, perform the following operations.

① Disconnect the HDMI cable and connect it again.

② Turn off and on this unit again.

“Connecting via the HDMI Connector” (☞ p. 55)

## Editing/Copying

### Unable to delete file.

Files (videos/still images) that are protected cannot be deleted. Release protection before deleting the file.

“Protecting Files” (☞ p. 60)

### Unable to create DVD with a DVD writer.

Connect the USB cable correctly.

“Preparing a DVD Writer (CU-VD50)” (☞ p. 78)

“Preparing a DVD Writer (CU-VD3)” (☞ p. 78)

### Unable to create disc with a BD writer (external Blu-ray drive).

Connect the USB cable correctly.

“Preparing a BD Writer (External Blu-ray Drive)” (☞ p. 69)

### BACK-UP menu does not disappear.

While the USB cable is connected, the “BACK UP” menu is displayed.

### Unable to turn off the BACK-UP menu.

Turn off the power of this unit and the DVD writer, or remove the AC adapter.

### Unable to delete folder in USB external hard disk drive.

Delete the folder using a computer.

(When files are added or folders moved/renamed with a computer, they cannot be deleted on this unit.)

## Computer

### Unable to copy files to the computer's HDD.

Before making backup, make sure that enough free space is left in the computer's hard disk (HDD).

### Unable to copy files to DVD or Blu-ray disc with a PC.

To record to discs, a recordable DVD or Blu-ray drive is required for the computer in use.

### I am using a Mac computer.

Copy the files to a Mac computer using the following method.  
 "Copying to Mac Computer" (☞ p. 94)

### The computer cannot recognize the SDXC card.

Confirm and update the OS of your computer.  
 "When your computer cannot recognize the SDXC card" (☞ p. 7)

## Screen/Image

### The LCD monitor is difficult to see.

The LCD monitor may be difficult to see if used in bright areas such as under direct sunlight.

### A band or a ball of bright light appears on the LCD monitor.

Change the direction of this unit to prevent the light source from coming into view. (A band or a ball of bright light may appear when there is a bright light source near this unit, but this is not a malfunction.)

### The recorded subject is too dark.

Use backlight compensation when the background is bright and the subject is dark.

"Setting Backlight Compensation" (☞ p. 29)

Use "NIGHTALIVE" in SCENE SELECT.

"Shooting According to Scene (Subject)" (☞ p. 32)

Use "GAIN UP" in the menu.

"GAIN UP" (☞ p. 97)

Set "BRIGHTNESS ADJUST" to the "+" side.

"Adjusting Brightness Manually" (☞ p. 29)

Decrease the shutter speed. (Subject may be blurred if the shutter speed is too slow.)

"Adjusting Shutter Speed" (☞ p. 30)

Set to a smaller aperture value.

"Adjusting Aperture" (☞ p. 30)

### The recorded subject is too bright.

Set the backlight compensation to "OFF" if it is being used.

"Setting Backlight Compensation" (☞ p. 29)

Set "BRIGHTNESS ADJUST" to the "-" side.

"Adjusting Brightness Manually" (☞ p. 29)

Increase the shutter speed.

"Adjusting Shutter Speed" (☞ p. 30)

Set to a larger aperture value.

"Adjusting Aperture" (☞ p. 30)

### The color looks strange. (Too bluish, too reddish, etc.)

Wait for a while until natural colors are achieved. (It may take some time for white balance to be adjusted.)

Set "WHITE BALANCE" to "MANUAL". Select from "5200K"/"6000K"/

"3200K" according to the light source. Select "MWB" and adjust accordingly.

"Setting White Balance" (☞ p. 31)

### The color looks different.

Set "WHITE BALANCE" to "MANUAL". Select from "5200K"/"6000K"/

"3200K" according to the light source. Select "MWB" and adjust accordingly.

"Setting White Balance" (☞ p. 31)

### There are bright or dark spots on the screen.

While the LCD monitor screen and viewfinder have more than 99.99% effective pixels, 0.01% of the pixels may be bright spots (red, blue, green) or dark spots. This is not a malfunction. The spots will not be recorded.

### Other Problems

#### The buttons on the touch screen do not work.

Tap the buttons on the touch screen with your fingers. The buttons may not respond if you touch them with your fingernails or with gloves on.

Save the recorded data before requesting service.

① Connect to a computer using a USB cable.

The "SELECT DEVICE" menu appears.

② Press and hold the REC button for more than 2 seconds.

The "PLAYBACK ON PC" appears.

Operations are to be performed on the computer after the screen switches.

#### The image is grainy.

When digital zoom is used, the image becomes grainy as it is digitally enlarged.

#### This unit heats up.

This is not a malfunction. (This unit may become warm when used for a long time.) Stop using the unit if it gets too warm.

#### The language on the display changed.

It may occur when you connect this unit to a TV with different language setting using an HDMI cable.

"Operating in Conjunction with TV via HDMI" (p. 56)

#### When connected to the TV via the HDMI cable, proper images and sounds are not output.

Images and sounds may not be output properly depending on the TV connected. In such cases, perform the following operations.

① Disconnect the HDMI cable and connect it again.

② Turn off and on this unit again.

"Connecting via the HDMI Connector" (p. 55)

#### HDMI-CEC functions do not work properly, and the TV does not work in conjunction with this unit.

TVs may operate differently depending on the specifications, even if they are HDMI-CEC compliant. Therefore, the HDMI-CEC functions of this unit cannot be guaranteed to operate in combination with all the TVs.

In such cases, set "HDMI CONTROL" to "OFF".

"HDMI CONTROL" (p. 108)

#### The unit operates slowly when switching between video mode and still image mode, or when switching the power on or off.

It is recommended that you copy all videos and still images onto your computer, and erase the files from this unit. (If there are many recorded files on this unit, it takes time for the unit to respond.)

#### This unit does not function properly and error messages appear.

This unit is a microcomputer-controlled device. Electrostatic discharge, external noise and interference (from a TV, a radio, etc.) might prevent it from functioning properly. In such a case, turn off the power, then remove the AC adapter and battery pack. This unit will be reset.

#### Operation disabled since the POWER/CHARGE lamp and the ACCESS lamp are blinking

After turning off the power, remove the power source (battery and AC adapter); reconnect and turn on the power. If these operations won't solve the problem, contact your JVC dealer or the JVC service center.

#### Disclaimer

- We shall not be held responsible for loss of recorded contents when recording videos/audio or playback cannot be operated due to malfunctions in this unit, provided parts, or SD card.

- Once deleted, recorded contents (data), including data loss due to malfunctions in this unit, cannot be restored. Please be forewarned.

- JVC will not be responsible for any lost data. Please be forewarned.

- In order for quality improvement, defective recording medium is subject to be analyzed. Therefore, it may not be returned.



## Error Message?

### CHECK LENS COVER

Open the lens cover.

### SET DATE/TIME!

Connect the AC adapter, charge the battery for more than 24 hours and set the clock. (If the message still appears, the clock battery is exhausted. Consult your nearest JVC dealer.)

“Clock Setting” (☞ p. 12)

### COMMUNICATION ERROR

Reconnect the USB cable.

Turn off this unit and the devices connected to it, and turn them on again.

Reattach the battery pack.

### MEMORY CARD ERROR!

Check that the card is supported by this unit.

“Types of Usable SD Card” (☞ p. 7)

Turn off and on this unit again.

Remove the AC adapter and battery pack, then remove and re-insert the SD card.

Remove any dirt from the SD card terminals.

If the above does not solve the problem, back up your files and execute “FORMAT SD CARD” in the “COMMON” menu. (All data will be deleted.)

“FORMAT SD CARD” (☞ p. 109)

### NOT FORMATTED

Select “OK”, then select “YES” on the “DO YOU WANT TO FORMAT?” screen.

### RECORDING FAILURE

Turn off and on this unit again.

### CANNOT TAKE MORE STILL IMAGES AT THIS TIME

Stop video recording before taking still images. (If the SD card is removed and inserted during video recording, still images cannot be recorded.)

### PLAYBACK FAILED

Remove and re-insert the SD card.

“Inserting an SD Card” (☞ p. 6)

Remove any dirt from the SD card terminals.

Insert the SD card before turning on the power.

Protect the unit from vibration and shock.

### VIDEO MANAGEMENT FILE IS DAMAGED, RECOVERY IS REQUIRED TO RECORD/PLAYBACK, RECOVER?

Select “OK” to restore. (Videos that cannot be restored will not be displayed on the index screen, but you may be able to play them back using

“PLAYBACK OTHER FILE” in the menu.)

“PLAYBACK OTHER FILE” (☞ p. 51)

### UNSUPPORTED SCENE!

Use files recorded with this unit. (Files recorded with other devices may not be playable.)

### UNSUPPORTED FILE!

Use files recorded with this unit. (Files recorded with other devices may not be playable.)

### THIS FILE IS PROTECTED

Switch off the “PROTECT/CANCEL” function in the “EDIT” menu.

“Protecting Files” (☞ p. 60)

### CHECK CARD'S WRITE PROTECTION SWITCH

Set the write protect switch of the SD card to off.

### INSUFFICIENT AVAILABLE SPACE

Delete files, or move files to a computer or other devices.

Replace the SD card with a new one.

### RECORDABLE MANAGEMENT CAPACITY LEVEL HAS BEEN REACHED

① Move the files or folders to a computer or other device. (Back up your files.)

② Select “FILE + MANAGEMENT NO” in “FORMAT SD CARD” of the media settings menu. (All data on the SD card will be deleted.)

“FORMAT SD CARD” (☞ p. 109)

### SCENE QUANTITY EXCEEDED LIMIT

1000 videos (\*\*000.mts to \*\*999.mts) can be recorded.

① Move the files or folders to a computer or other device. (Back up your files.)

② Select “FILE + MANAGEMENT NO” in “FORMAT SD CARD” of the media settings menu. (All data on the SD card will be deleted.)

“FORMAT SD CARD” (☞ p. 109)

### NUMBER OF FOLDERS OVERFLOW

① Move the files or folders to a computer or other device. (Back up your files.)

② Select “FILE + MANAGEMENT NO” in “FORMAT SD CARD” of the media settings menu. (All data on the SD card will be deleted.)

“FORMAT SD CARD” (☞ p. 109)

### FILE QUANTITY LIMIT EXCEEDED

① Move the files or folders to a computer or other device. (Back up your files.)

② Select “FILE + MANAGEMENT NO” in “FORMAT SD CARD” of the media settings menu. (All data on the SD card will be deleted.)

“FORMAT SD CARD” (☞ p. 109)

---

### PLAYLIST QUANTITY EXCEEDS LIMIT

Reduce the number of the playlist to 99 files or less. (Up to 99 playlists can be created.)

---

### CANCELLED BECAUSE PLAYLIST AMOUNT EXCEEDED MAXIMUM LIMIT

When creating a DVD, reduce the number of playlists to be saved.  
Reduce the number of videos to add to the playlist to 999 files.  
“Creating Playlists from the Recorded Videos” (p. 63)

---

### PROCESSING CANCELLED DUE TO LIMITED SPACE FOR OPERATION

Reduce the number of videos to add to the playlist to 999 files.  
“Creating Playlists from the Recorded Videos” (p. 63)

---

### NO FILES

Change the setting of “REC STILL TO SLOTS” or “REC VIDEO TO SLOTS” in the “MEDIA SETTINGS” menu, and check that files are not recorded to the other media.  
“REC VIDEO TO SLOTS” (p. 109)  
“REC STILL TO SLOTS” (p. 109)

---

### RECORDING CANCELLED

Set “REC VIDEO TO SLOTS” to the other SD card, then record.  
“REC VIDEO TO SLOTS” (p. 109)  
Turn off and on this unit again.  
Protect the unit from vibration and shock.

---

### CAMERA TEMPERATURE IS HIGH PLEASE TURN CAMERA OFF TO ALLOW IT TO COOL DOWN PLEASE WAIT

Turn off the power of this unit, let and it cool down before turning on the power again.

---

### POWER IS OFF, OR USB DEVICE IS UNSUPPORTED

Turn on the power of the connected USB device.  
Connect the AC adapter to the DVD writer or BD writer (external Blu-ray drive).

---

### INSERT DISC

Open the tray of the DVD writer or BD writer (external Blu-ray drive), check and reset the DVD or Blu-ray disc, then close the tray.  
Replace the disc in the DVD writer or BD writer (external Blu-ray drive).

---

### CHANGE DISC

Open the tray of the DVD writer or BD writer (external Blu-ray drive), check and reset the DVD or Blu-ray disc, then close the tray.  
Replace the disc in the DVD writer or BD writer (external Blu-ray drive).

Perform regular maintenance of this unit to enable it to be used for a long time.

**Caution :**

- Be sure to detach the battery pack, AC adapter, and power plug before performing any maintenance.

**Camcorder**

- Wipe this unit with a dry, soft cloth to remove any dirt.
- When it is extremely dirty, soak the cloth in a solution of neutral detergent, wipe the body with it, and then use a clean cloth to remove the detergent.

**Caution :**

- Do not use solvents such as benzene, thinner, or alcohol. Doing so may cause damage to the unit.
- When using a chemical cloth or cleaner, be sure to observe the warning labels and instructions of the product.
- Do not leave the device in contact with rubber or plastic products for a long time.

**Lens/LCD Monitor/Viewfinder**

- Use a lens blower (commercially available) to remove any dust, and a cleaning cloth (commercially available) to wipe off any dirt.  
Mold may form if the lens is left dirty.
- You can use a commercially available anti-reflection or protective film on the screen.  
However, depending on the thickness of the film, operations on the touch screen may not be performed smoothly or the screen may darken slightly.

**Camera**

Item	Details
Power supply	Using AC adapter: DC 11 V Using battery pack: DC 7.2 V
Power consumption	3.6 W (50i mode, MONITOR BRIGHTNESS: 3 (standard)) 3.8 W (50i mode, MONITOR BRIGHTNESS: 4 (brighter)) 4.0 W (50p mode, MONITOR BRIGHTNESS: 3 (standard)) 4.2 W (50p mode, MONITOR BRIGHTNESS: 4 (brighter)) Rated Current Consumption: 1A
Dimensions (mm)	227 x 232 x 472 (W x H x D: excluding grip belt)
Mass	Approx. 2.9 kg (camera only), Approx. 3.1 kg (with two BN-VF823U battery packs attached)
Operating environment	Allowable operating temperature: 0 °C to 40 °C Allowable storage temperature: -20 °C to 50 °C Allowable relative humidity: 35 % to 80 %
Image pickup device	1/2.3" 12,760,000 pixels (CMOS, back-illuminated)
Recording area (Video)	2,070,000 to 5,400,000 pixels (image stabilizer: OFF, dynamic zoom: ON)
Recording area (Still image)	4,500,000 to 6,040,000 pixels (4:3) (image stabilizer: OFF) 2,070,000 to 5,400,000 pixels (16:9) (image stabilizer: OFF)
Lens	F1.2 - F2.8, f = 3.76 mm to 37.6 mm Video 35 mm conversion: 29.5 mm to 476 mm (dynamic zoom: ON)* 35 mm conversion: 29.5 mm to 406 mm (dynamic zoom: OFF)* Still Image 35 mm conversion: 29.8 mm to 345 mm (4:3) 35 mm conversion: 34.4 mm to 397 mm (16:9) * Calculated when "IS" is set to "OFF" on the wide (W) end and "IS" is set to "ON (AIS)" on the tele (T) end.

Item	Details
Filter diameter	46 mm (screw pitch: 0.75 mm)
Lowest illumination	10 lux (GAIN UP: ON) 1 lux (GAIN UP: AUTO SLOW-SHUTTER) 1 lux (SCENE SELECT: NIGHTALIVE)
Zoom (during video recording)	Optical zoom: Up to 10x Dynamic zoom: 11 - 16x (image stabilizer: OFF), 11 - 14x (image stabilizer: ON), 11- 13x (image stabilizer: ON (AIS)) Digital zoom: Up to 200x
Zoom (during still image recording)	Optical zoom: Up to 10x
Continuous shooting speed (during video record-standby)	LOW SPEED: Approx. 1.5 images/second (Maximum)
CONT. SHOOTING SPEED (during still image recording)	HIGH SPEED: Approx. 12.5 images/second MEDIUM SPEED: Approx. 6.25 images/second LOW SPEED: Approx. 2 images/second (Maximum)
LCD monitor	3.0", 230,000 pixels, color LCD
Viewfinder	0.24", 260,000 pixels, color LCD
Recording Media	SD/SDHC/SDXC card (commercially available) "Types of Usable SD Card" (p. 7)
Clock battery	Primary battery

## Connectors

Item	Details
HDMI output connector	HDMI connector
AV output connector	Video output: 1.0 V (p-p), 75 $\Omega$ Audio output: 300 mV (rms), 1 k $\Omega$
USB Connector	Mini USB Type AB, USB 2.0 compliant

## Video

Item	Details
Recording/ Playback format	AVCHD standard Ver 2.0 (AVCHD Progressive) Video: MPEG-4 AVC/H.264 Audio: Dolby Digital 2ch
Extension	.MTS
Signal system	PAL standard
Image quality (Video)	50p 1920 x 1080 pixels Maximum Approximate 28 Mbps UXP 1920 x 1080 pixels Average Approximate 24 Mbps XP 1920 x 1080 pixels Average Approximate 17 Mbps SP 1920 x 1080 pixels Average Approximate 12 Mbps EP 1920 x 1080 pixels Average Approximate 4.8 Mbps SSW(16:9) 720 x 576 pixels Average Approximate 6.2 Mbps SEW(16:9) 720 x 576 pixels Average Approximate 3 Mbps
Sound quality (Audio)	48 kHz, 256 kbps

## Still Image

Item	Details
Recording format	JPEG standard
Extension	.JPG
Image Size	"Approximate Number of Still Images (Unit: Number of Shots)" (p. 44)

## AC Adapter (UIA324-1220)

Item	Details
Power supply	AC 110 V to 240 V, 50 Hz/60 Hz
Output	DC 12 V, 2 A
Allowable operating temperature	0°C to 40°C (10°C to 35°C during charging)
Dimensions (mm)	43.8 x 28.5 x 95.9 (W x H x D: excluding cord and AC plug)
Mass	Approx. 120 g

## Battery Pack (BN-VF823)

Item	Details
Dimensions (mm)	30.5 x 51.6 x 46.2 (W x H x D)
Mass	Approx. 125 g

### Memo :

- The specifications and appearance of this product are subject to changes for further improvement without prior notice.

Dimensional Outline Drawing (Unit: mm)

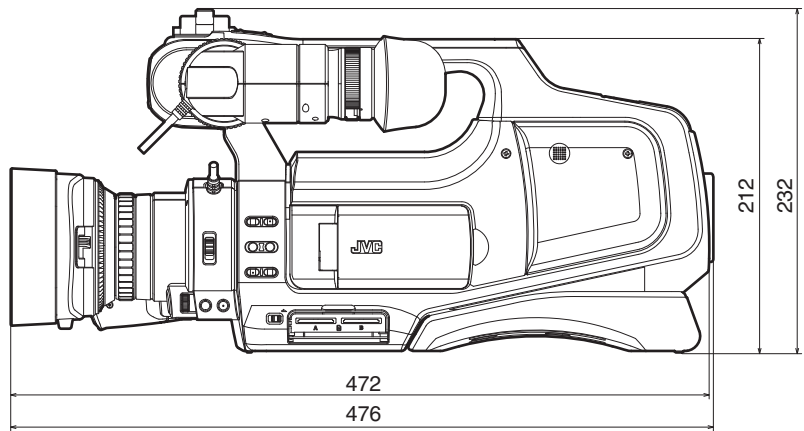
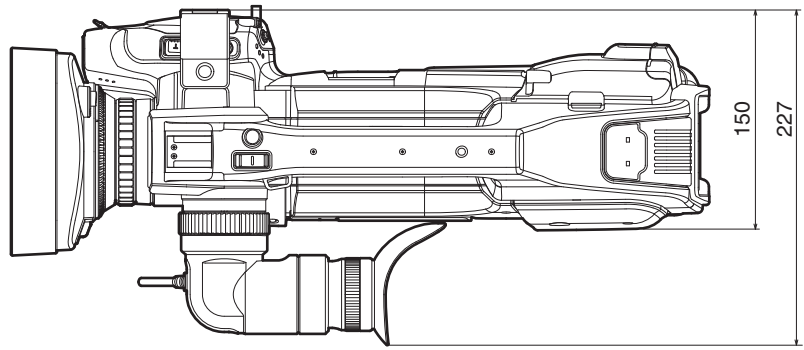
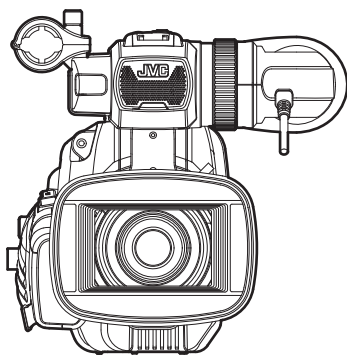



**JVC**